



# AW2400

PROFESSIONAL AUDIO WORKSTATION

## Owner's Manual



## FCC INFORMATION (U.S.A.)

### 1. IMPORTANT NOTICE: DO NOT MODIFY THIS UNIT!

This product, when installed as indicated in the instructions contained in this manual, meets FCC requirements. Modifications not expressly approved by Yamaha may void your authority, granted by the FCC, to use the product.

**2. IMPORTANT:** When connecting this product to accessories and/or another product use only high quality shielded cables. Cable/s supplied with this product MUST be used. Follow all installation instructions. Failure to follow instructions could void your FCC authorization to use this product in the USA.

**3. NOTE:** This product has been tested and found to comply with the requirements listed in FCC Regulations, Part 15 for Class "B" digital devices. Compliance with these requirements provides a reasonable level of assurance that your use of this product in a residential environment will not result in harmful interference with other electronic devices. This equipment generates/uses radio frequencies and, if not installed and used according to the instructions found in the users manual, may cause interference harmful to the operation of other electronic

devices. Compliance with FCC regulations does not guarantee that interference will not occur in all installations. If this product is found to be the source of interference, which can be determined by turning the unit "OFF" and "ON", please try to eliminate the problem by using one of the following measures:

Relocate either this product or the device that is being affected by the interference.

Utilize power outlets that are on different branch (circuit breaker or fuse) circuits or install AC line filter/s.

In the case of radio or TV interference, relocate/reorient the antenna. If the antenna lead-in is 300 ohm ribbon lead, change the lead-in to co-axial type cable.

If these corrective measures do not produce satisfactory results, please contact the local retailer authorized to distribute this type of product. If you can not locate the appropriate retailer, please contact Yamaha Corporation of America, Electronic Service Division, 6600 Orangethorpe Ave, Buena Park, CA90620

The above statements apply ONLY to those products distributed by Yamaha Corporation of America or its subsidiaries.

\* This applies only to products distributed by YAMAHA CORPORATION OF AMERICA.

(class B)

### COMPLIANCE INFORMATION STATEMENT (DECLARATION OF CONFORMITY PROCEDURE)

Responsible Party : Yamaha Corporation of America  
Address : 6600 Orangethorpe Ave., Buena Park, Calif. 90620  
Telephone : 714-522-9011  
Type of Equipment : Professional Audio Workstation  
Model Name : AW2400

This device complies with Part 15 of the FCC Rules.

Operation is subject to the following two conditions:

- 1) this device may not cause harmful interference, and
- 2) this device must accept any interference received including interference that may cause undesired operation.

See user manual instructions if interference to radio reception is suspected.

\* This applies only to products distributed by  
YAMAHA CORPORATION OF AMERICA.

(FCC DoC)

### IMPORTANT NOTICE FOR THE UNITED KINGDOM

#### Connecting the Plug and Cord

**WARNING:** THIS APPARATUS MUST BE EARTHED  
IMPORTANT. The wires in this mains lead are coloured in accordance with the following code:

GREEN-AND-YELLOW : EARTH  
BLUE : NEUTRAL  
BROWN : LIVE

As the colours of the wires in the mains lead of this apparatus may not correspond with the coloured markings identifying the terminals in your plug proceed as follows:

The wire which is coloured GREEN-and-YELLOW must be connected to the terminal in the plug which is marked by the letter E or by the safety earth symbol  or colored GREEN or GREEN-and-YELLOW.

The wire which is coloured BLUE must be connected to the terminal which is marked with the letter N or coloured BLACK.

The wire which is coloured BROWN must be connected to the terminal which is marked with the letter L or coloured RED.

\* This applies only to products distributed by Yamaha-Kemble Music (U.K.) Ltd.

(3 wires)

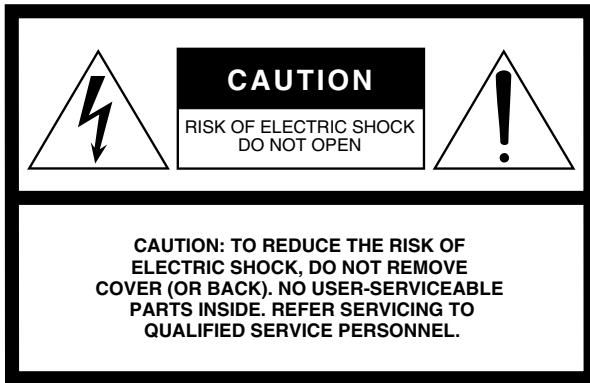

The above warning is located on the rear of the unit.

## Explanation of Graphical Symbols

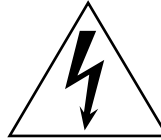

The lightning flash with arrowhead symbol within an equilateral triangle is intended to alert the user to the presence of uninsulated “dangerous voltage” within the product’s enclosure that may be of sufficient magnitude to constitute a risk of electric shock to persons.



The exclamation point within an equilateral triangle is intended to alert the user to the presence of important operating and maintenance (servicing) instructions in the literature accompanying the product.

# IMPORTANT SAFETY INSTRUCTIONS

- 1 Read these instructions.
- 2 Keep these instructions.
- 3 Heed all warnings.
- 4 Follow all instructions.
- 5 Do not use this apparatus near water.
- 6 Clean only with dry cloth.
- 7 Do not block any ventilation openings. Install in accordance with the manufacturer’s instructions.
- 8 Do not install near any heat sources such as radiators, heat registers, stoves, or other apparatus (including amplifiers) that produce heat.
- 9 Do not defeat the safety purpose of the polarized or grounding-type plug. A polarized plug has two blades with one wider than the other. A grounding type plug has two blades and a third grounding prong. The wide blade or the third prong are provided for your safety. If the provided plug does not fit into your outlet, consult an electrician for replacement of the obsolete outlet.
- 10 Protect the power cord from being walked on or pinched particularly at plugs, convenience receptacles, and the point where they exit from the apparatus.

- 11 Only use attachments/accessories specified by the manufacturer.
- 12 Use only with the cart, stand, tripod, bracket, or table specified by the manufacturer, or sold with the apparatus. When a cart is used, use caution when moving the cart/apparatus combination to avoid injury from tip-over.
- 13 Unplug this apparatus during lightning storms or when unused for long periods of time.
- 14 Refer all servicing to qualified service personnel. Servicing is required when the apparatus has been damaged in any way, such as power-supply cord or plug is damaged, liquid has been spilled or objects have fallen into the apparatus, the apparatus has been exposed to rain or moisture, does not operate normally, or has been dropped.



### WARNING

TO REDUCE THE RISK OF FIRE OR ELECTRIC SHOCK, DO NOT EXPOSE THIS APPARATUS TO RAIN OR MOISTURE.

(98-6500)

This product contains a high intensity lamp that contains a small amount of mercury. Disposal of this material may be regulated due to environmental considerations. For disposal information in the United States, refer to the Electronic Industries Alliance web site: [www.eiae.org](http://www.eiae.org)

\* This applies only to products distributed by YAMAHA CORPORATION OF AMERICA.

(mercury)

# PRECAUTIONS

## PLEASE READ CAREFULLY BEFORE PROCEEDING

\* Please keep this manual in a safe place for future reference.



### WARNING

Always follow the basic precautions listed below to avoid the possibility of serious injury or even death from electrical shock, short-circuiting, damages, fire or other hazards. These precautions include, but are not limited to, the following:

#### Power supply/Power cord

- Only use the voltage specified as correct for the device. The required voltage is printed on the name plate of the device.
- Use only the included power cord.
- Do not place the power cord near heat sources such as heaters or radiators, and do not excessively bend or otherwise damage the cord, place heavy objects on it, or place it in a position where anyone could walk on, trip over, or roll anything over it.
- Be sure to connect to an appropriate outlet with a protective grounding connection. Improper grounding can result in electrical shock.

#### Do not open

- Do not open the device or attempt to disassemble the internal parts or modify them in any way. The device contains no user-serviceable parts. If it should appear to be malfunctioning, discontinue use immediately and have it inspected by qualified Yamaha service personnel.

#### Water warning

- Do not expose the device to rain, use it near water or in damp or wet conditions, or place containers on it containing liquids which might spill into any openings.
- Never insert or remove an electric plug with wet hands.

#### If you notice any abnormality

- If the power cord or plug becomes frayed or damaged, or if there is a sudden loss of sound during use of the device, or if any unusual smells or smoke should appear to be caused by it, immediately turn off the power switch, disconnect the electric plug from the outlet, and have the device inspected by qualified Yamaha service personnel.
- If this device should be dropped or damaged, immediately turn off the power switch, disconnect the electric plug from the outlet, and have the device inspected by qualified Yamaha service personnel.



### CAUTION

Always follow the basic precautions listed below to avoid the possibility of physical injury to you or others, or damage to the device or other property. These precautions include, but are not limited to, the following:

#### Power supply/Power cord

- Remove the electric plug from the outlet when the device is not to be used for extended periods of time, or during electrical storms.
- When removing the electric plug from the device or an outlet, always hold the plug itself and not the cord. Pulling by the cord can damage it.

#### Location

- Before moving the device, remove all connected cables.
- When setting up the product, make sure that the AC outlet you are using is easily accessible. If some trouble or malfunction occurs, immediately turn off the power switch and disconnect the plug from the outlet. Even when the power switch is turned off, electricity is still flowing to the product at the minimum level. When you are not using the product for a long time, make sure to unplug the power cord from the wall AC outlet.
- Avoid setting all equalizer controls and faders to their maximum. Depending on the condition of the connected devices, doing so may cause feedback and may damage the speakers.

- Do not expose the device to excessive dust or vibrations, or extreme cold or heat (such as in direct sunlight, near a heater, or in a car during the day) to prevent the possibility of panel disfiguration or damage to the internal components.
- Do not place the device in an unstable position where it might accidentally fall over.
- The plastic side panels do not provide a secure grip, and should not be used as handles when moving or transporting the unit. Carrying the unit by the plastic side panels can result in the unit being dropped, which could damage the unit and/or cause personal injury.
- Do not block the vents. This device has ventilation holes at the top/front/rear to prevent the internal temperature from becoming too high. In particular, do not place the device on its side or upside down. Inadequate ventilation can result in overheating, possibly causing damage to the device(s), or even fire.
- Do not use the device in the vicinity of a TV, radio, stereo equipment, mobile phone, or other electric devices. Doing so may result in noise, both in the device itself and in the TV or radio next to it.

## Connections

- Before connecting the device to other devices, turn off the power for all devices. Before turning the power on or off for all devices, set all volume levels to minimum.
- Be sure to connect to a properly grounded power source. A ground screw is provided on the rear panel of this device for maximum safety and shock prevention. If the mains outlet is not grounded, be sure to connect the ground screw to a confirmed ground point before plugging the device into the mains. Improper grounding can result in electrical shock.

## Handling caution

- When turning on the AC power in your audio system, always turn on the power amplifier LAST, to avoid speaker damage. When turning the power off, the power amplifier should be turned off FIRST for the same reason.
- Do not insert your fingers or hands in any gaps or openings on the device (vents, disc slots, etc.).
- Avoid inserting or dropping foreign objects (paper, plastic, metal, etc.) into any gaps or openings on the device (vents, disc slots, etc.) If this happens, turn off the power immediately and unplug the power cord from the AC outlet. Then have the device inspected by qualified Yamaha service personnel.
- Do not use headphones for a long period of time at a high or uncomfortable volume level, since this can cause permanent hearing loss. If you experience any hearing loss or ringing in the ears, consult a physician.
- Do not rest your weight on the device or place heavy objects on it, and avoid use excessive force on the buttons, switches or connectors.

XLR-type connectors are wired as follows (IEC60268 standard): pin 1: ground, pin 2: hot (+), and pin 3: cold (-).

Insert TRS phone jacks are wired as follows: sleeve: ground, tip: send, and ring: return.

Yamaha cannot be held responsible for damage caused by improper use or modifications to the device, or data that is lost or destroyed.

Always turn the power off when the device is not in use.

The performance of components with moving contacts, such as switches, volume controls, and connectors, deteriorates over time. Consult qualified Yamaha service personnel about replacing defective components.

## Caution for Laser

This product utilizes a laser.

Use of control, adjustment or performance of procedures other than those specified herein may result in hazardous radiation exposure.

Do not open covers and do not repair yourself. Refer servicing to qualified personnel.

### Laser properties of the Drive

Laser Class : Class 1 (HHS and IEC 825-1)

Wavelength : for CD 784 nm  
for DVD 662 nm

The label shown below is located on the rear of this product.



CLASS 1 LASER PRODUCT

The label shown below is located on the top of the internal CD-RW drive.

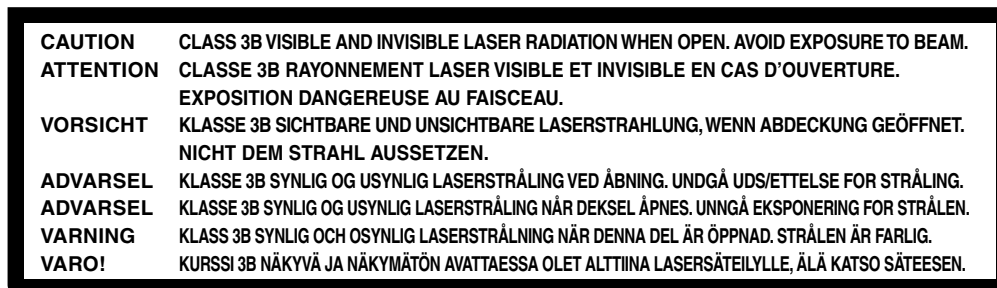

CAUTION: CLASS 3B VISIBLE AND INVISIBLE LASER RADIATION WHEN OPEN. AVOID EXPOSURE TO BEAM.

## Handling the CD-R/RW media

Please observe the following points when handling the disc.

Failure to do so may cause problems such as the recorded data being lost, the drive to malfunction, or the printed label to become blurred.

- Do not place the disc in locations of direct sunlight, high temperature, or high humidity.
- Do not touch the recording surface of the disc.  
Hold the disc at the edges.
- Gently wipe dust or dirt off of the recording surface of the disc.  
Use an air duster or cleaner to remove dust. Vigorously rubbing the surface of the disc with a dry cloth may scratch the disc.
- If the disc surface needs cleaning, wipe gently from the center to the outside of the disc with a soft damp cloth, then gently wipe off remaining moisture in the same way with a clean dry cloth.
- Do not write on the disc or affix labels to it.
- Do not wipe the disc with chemicals or detergents.
- Do not bend or drop the disc.

## Internal Hard Disk Precautions

- During some hard disk operations a small amount of vibration might be felt at the control panel and you might hear some mechanical noises. This is normal.
- Do not subject the unit to strong physical shock. Excessive physical shock can damage the internal hard disk.
- Always turn the power off when moving the unit from one location to another. Data on the internal hard disk can be lost or corrupted if the unit is moved while the power is on.

## Copyright Notice

Copyright and other intellectual property laws in various countries permit reproduction of copyrighted materials under certain requirements. The observance of applicable laws for use of this product, however, is your responsibility. Yamaha disclaims any liability for violation of such laws in association with the use of this product.

Although this product is designed for original music production, it can be utilized to make reproduction of copyrighted music and other sound products. While certain reproduction and use of reproduced materials are permitted under applicable laws, such reproduction and use without license may constitute copyright infringement and other violation of laws. Since violation of such laws can have serious consequences, you may wish to consult a legal expert about your planned use of this product.

This product incorporates and bundles computer programs and contents in which Yamaha owns copyrights or with respect to which it has license to use others' copyrights. Such copyrighted materials include, without limitation, all computer software, styles files, MIDI files, WAVE data and sound recordings. Any unauthorized use of such programs and contents outside of personal use is not permitted under relevant laws. Any violation of copyright has legal consequences. **DON'T MAKE, DISTRIBUTE OR USE ILLEGAL COPIES.**

The illustrations and LCD screens as shown in this owner's manual are for instructional purposes only, and may appear somewhat different from those on your instrument.

# Contents

<b>1. Before you start</b>	<b>11</b>		
Introduction	11	Recording on a track	56
Remember to back up your data	11	Saving the current song	57
About the built-in CD-RW drive	12	Pairing channels	58
Using the CD-RW drive	12	Applying EQ To an Input Signal	60
Installing an optional card	13	Applying Compression to an Input Signal	61
		Handy Recording Functions	62
		Using the Metronome	62
		Switching virtual tracks	63
		Using the Undo List	64
<b>2. Introducing the AW2400</b>	<b>15</b>		
Features of the AW2400	15	<b>7. Overdubbing</b>	<b>65</b>
AW2400 terminology	17	About overdubbing	65
Recorder section	17	Assigning the input signal to a track	66
Mixer section	18	Setting the mix balance and pan	67
Overall	19	Overdubbing	68
Parts of the AW2400 and what they do	20	Punch-in/out	69
Top panel	20	Manual punch-in/out	69
Rear panel	28	Auto punch-in/out	70
Front panel	29		
Basic operation of the AW2400	30	<b>8. Mixdown and bounce operations</b>	<b>73</b>
Viewing the display	30	About mixdown and bouncing	73
Accessing a screen/page	31	Mixdown procedure	75
Switching a button on/off	31	Playing back the stereo track	78
Editing a value in the display	31	Bounce (ping-pong) recording procedure	79
Using Additional Function Buttons	31	Convenient functions for mixdown/bounce	82
Entering text	32	Fader Group assignments	82
Switching Mixing Layers	33	Mute Group assignments	83
Using the Selected Channel section	33	Using the Solo function	84
<b>3. Connection and Setup</b>	<b>37</b>	<b>9. Transport/Locate Operation</b>	<b>87</b>
Connection	37	The Transport Section Keys	87
Turning the power on/off	38	Move To a Specified Location	87
Adjusting the input level	39	Using the locator	88
		Using markers	90
		Adjusting the position of a locate point or marker	91
		Adjusting the position of a locate point	91
		Adjusting the position of a marker	92
		Erasing a locate point or marker	93
		Repeat playback of a specific region (the A-B Repeat function)	93
		Finding a location while monitoring the sound (the Nudge function)	94
		Finding a location while viewing the waveform	95
<b>4. Listening to the demo song</b>	<b>41</b>		
Loading the demo song	41	<b>10. Meters</b>	<b>97</b>
Playing the demo song	42	Level Meter Types	97
<b>5. Recording to a sound clip</b>	<b>43</b>		
Recording a sound clip	43		
Playing a sound clip	45		
<b>6. Track recording</b>	<b>47</b>		
Creating a new song	47		
Direct recording and Mixed recording	49		
Assigning input signals to tracks (Direct recording)	51		
Assigning input signals to tracks (Mixed recording)	54		



<b>11. Patching and signal flow</b>	<b>99</b>	The Trigger Track Function .....	133
Input signal patching .....	99	About Trigger Track.....	133
Patching for Direct Recording .....	99	Using the Trigger Track Function .....	134
Patching for Mixed Recording.....	102	Editing tracks .....	135
Output signal patching.....	104	Basic procedure for track editing .....	136
<b>12. Channel Operation</b>	<b>105</b>	List of editing command.....	138
Displaying the mix parameters for individual channels.....	105	ERASE .....	138
Channel Library Operation .....	108	DELETE .....	138
Calling the Channel Library screen.....	108	INSERT .....	138
Changing Channel Library Names.....	109	COPY .....	139
Storing Channel Library settings.....	109	MOVE.....	140
Recalling Channel Library settings .....	110	EXCHANGE .....	141
Erasing Channel Library settings.....	110	TIME COMP (Time Compression/Expansion).....	141
<b>13. AUX</b>	<b>111</b>	PITCH (Pitch Change).....	142
About the AUX buses .....	111	IMPORT CD AUDIO.....	142
AUX Send Level Adjustment .....	111	IMPORT CD WAV .....	142
Using external effects with the AUX buses .....	113	IMPORT USB WAV .....	142
<b>14. Effects</b>	<b>115</b>	IMPORT TRACK .....	142
About the Internal Effects .....	115	EXPORT.....	142
Recalling Effect Library settings .....	116	MERGE .....	142
Applying Effects via Send and Return .....	117	Importing audio data/WAV files .....	143
Inserting an Effect Into a Channel .....	119	Importing from the CD-RW drive .....	143
Editing Effects .....	121	Importing audio data from another song .....	145
Effect Library Operations.....	122	<b>16. Pan, EQ, and Dynamics Processing</b>	<b>147</b>
Call the Effect Library Screen .....	122	Pan Control.....	147
Changing Effect Library Names .....	122	4-band EQ .....	149
Storing Effect Library settings.....	123	Dynamics Processing .....	151
Erasing Effect Library settings .....	123	Using the Gates.....	151
Correcting a Vocal Track (Pitch Fix).....	124	Using the Compressors.....	152
<b>15. Track operations and editing</b>	<b>127</b>	EQ/Dynamics Processor Library Operation.....	154
About the AW2400's tracks .....	127	Accessing the EQ/Dynamics Library screens .....	154
Audio track operations.....	128	Changing EQ/Dynamics Library Names.....	156
About audio tracks .....	128	Recalling EQ/Dynamics Library settings .....	156
Viewing all audio tracks .....	128	Storing EQ/Dynamics Library settings.....	157
Muting a specific audio track.....	129	Erasing EQ/Dynamics Library settings.....	157
Switching the virtual track of an audio track.....	129	<b>17. Scene Memory</b>	<b>159</b>
Editing virtual track names for an audio track.....	130	About Scene Memory .....	159
Stereo track operations .....	130	Scene Memory Operation.....	159
About the stereo track.....	130	Renaming a scene .....	160
Recording on the stereo track.....	131	Recalling scene data .....	160
Playing back the stereo track.....	131	Storing scene data .....	161
Switching the virtual track of the stereo track .....	132	Deleting scene data.....	161
Editing the name of a virtual track for the stereo track .....	132	Protecting a scene.....	161
		Using the Recall Safe function.....	162
		Moving scenes .....	163

**18. Song management 165**

About songs ..... 165  
 Managing Your Songs ..... 167  
 Editing various settings for the song ..... 174  
 Creating a tempo map ..... 175  
 Backing up songs ..... 177  
 Restoring songs ..... 178  
 Exchanging Song Data  
 With Other AW-series Audio Workstations ..... 180

**19. Automix 181**

About Automix ..... 181  
 Automix Operation ..... 181  
     Creating a New Automix Recording ..... 182  
     Recording the Automix Data ..... 183  
     Automix Playback ..... 185  
     Punch In and Out of Automix ..... 185  
 Command Editing Automix data  
 In a Specified Region ..... 186  
 Editing Individual Automix Events ..... 188  
 Automix Library Operation ..... 190  
     About the Automix Library Page ..... 190  
     Changing Automix Names ..... 190  
     Storing Automix settings ..... 191  
     Recalling Automix settings ..... 191  
     Erasing Automix settings ..... 191  
     Protecting Automix Data ..... 192

**20. MIDI 193**

What you can do using MIDI ..... 193  
 Basic MIDI Settings ..... 194  
 MIDI Synchronization Message Setup ..... 198  
 Connecting to External Equipment ..... 200  
     Synchronizing the AW2400  
     With External MIDI Devices ..... 200  
     Switching AW2400 scenes  
     from an external MIDI device ..... 201  
     Recording/playing AW2400  
     mix operations on an external sequencer ..... 202  
 Using the MIDI Remote function ..... 204  
     About the MIDI Remote function ..... 204  
     Using the MIDI Remote function presets ..... 204  
     Using User-defined Remote function ..... 206  
     Remotely controlling a tone generator module ..... 207

**21. Utility functions 209**

Using the test tone oscillator ..... 209  
 AW2400 Preferences ..... 210  
 Initializing the internal hard disk ..... 212

**22. Creating an audio CD 213**

Creating an audio CD ..... 213  
 Types of media that you can use  
 with the CD-RW drive ..... 213  
 Writing an audio CD ..... 214  
 Basic settings for the CD-RW drive ..... 215  
 Writing audio data ..... 216  
     Writing Track At Once ..... 217  
     Writing Disc At Once ..... 218  
 Finalizing CD-R/RW media ..... 220  
 Erasing CD-RW media ..... 221  
 Playing an audio CD ..... 222

**23. Digital Input/Output & Optional Card Settings 223**

Wordclock and Cascade Settings ..... 223  
     Select the Wordclock Source ..... 223  
     Fine Adjustment Of Overall  
     Song Pitch (Vari-pitch) ..... 226  
     Cascade-connecting External Devices ..... 226  
 Check the Status Of the Digital Input Signal ..... 227  
 Plug-in Card Settings ..... 228

**24. USB 229**

What You Can Do With USB ..... 229  
 WAV File Transfer (USB Storage Mode) ..... 230  
     Switching to the USB Storage Mode ..... 230  
     Exiting the USB Storage Mode ..... 232  
     Copying Exported WAV Files  
     To the Computer ..... 233  
     Importing Copied WAV Files  
     From the Computer ..... 234

**Appendix 237**

Mastering library list ..... 237  
 EQ Parameter list ..... 238  
 Dynamics Parameters ..... 240  
 Gate Parameter list ..... 243  
 Compressor Parameter list ..... 243  
 Effects Parameters ..... 245  
 Troubleshooting ..... 258  
 Display message list ..... 263  
 About the CD-ROM included with the AW2400 ..... 266  
 MIDI data format ..... 272  
 MIDI Implementation Chart ..... 276  
 Specifications ..... 277  
 Dimensions ..... 279  
 Index ..... 280  
 Block diagram ..... 284

# Before you start

This chapter explains what you should know before you begin using the AW2400.

## Introduction

### ■ Check the included items

The AW2400 package contains the following items. If any are missing, please contact your dealer.

- The AW2400
- Power cord
- Owner's manual (this book)
- CD-ROM

### ■ Copyright

Copying of commercially available music sequence data and/or digital audio files for any purpose other than your own personal use is strictly prohibited.

### ■ Trademarks

- Macintosh is a registered trademark of Apple Computer, Inc. USA in the United States and other countries.
- Windows is a registered trademark of Microsoft Corporation USA in the United States and other countries.
- Cubase SX and Nuendo are trademarks of Steinberg Media Technologies AG.
- Logic is a registered trademark of Apple Computer, Inc. USA in the United States and other countries.
- SONAR is a registered trademark of Twelve Tone Systems, Inc.
- ProTools is a trademark or registered trademark of Avid Technology, Inc. and affiliated companies.
- Other company names and product names in this document are the trademarks or registered trademarks of their respective owners.

### ■ Yamaha Website (English only)

<http://www.yamahasynt.com/>

### ■ Yamaha Manual Library

<http://www.yamaha.co.jp/manual/>

## Remember to back up your data

### ■ Storing produced data

Produced data can be lost due to breakdown or mistaken operation. We recommend that you store all important data on your computer, CD-R/CD-RW discs, or other external storage medium.

### ■ Responsibility for loss of data, etc.

Yamaha will accept no responsibility for any damages (including consequential or incidental) incurred by the customer or any third party as a result of loss or impairment of the data stored on the hard disk or CD-R media, regardless of whether such loss could have been or actually was foreseen by Yamaha. Nor does Yamaha guarantee the media against any defect that may render it unusable.

## About the built-in CD-RW drive

A built-in CD-RW drive is a device that lets you create or play audio CDs, backup and restore data from the internal hard disk, and read data from a CD-ROM.

### IMPORTANT

- Even if a CD-RW drive is operating normally, it may fail a read or write operation approximately once in five hundred times.
- Yamaha will take no responsibility for any damages, direct or consequential, that may result from the use of the above CD-RW drive.

### Handling

- ① Never touch the objective lens.
- ② Be careful that the objective lens does not become dusty or dirty.
- ③ If the objective lens becomes dusty, use a commercially available blower etc. to blow the dust off with clean air.
- ④ Since the inside of the drive contains powerful magnetic circuitry, do not allow any magnetic material to come near the drive. (In particular, any metallic fragments, screws, or pins that enter the drive mechanism will cause operation to fail.)

## Using the CD-RW drive

To insert a disc into the CD-RW drive, press the eject switch. The disc tray will open. Place the disc on the tray, and gently push the disc tray in.

### NOTE

- The disc tray is ejected electrically. If the disc tray is not ejected when you press the eject switch, turn on the power of the AW2400 and press the eject switch once again.

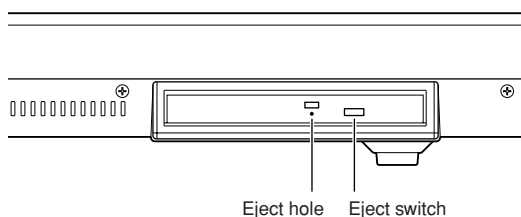

### Removing a CD in an emergency

If you are unable to remove the disc by pressing the eject switch, insert a wire of less than 2 mm diameter (such as a straightened paper clip) into the eject hole, and push gently. However, pressing the eject switch will not eject the disc when the AW2400 is in the following states, so do not use this method in such cases.

- When the AW2400's power is "OFF"
- When the disc is being accessed (data is being read, written, or erased)
- While in CD PLAY mode

### CAUTION

- This removal method is for use in emergencies such as when you cannot remove the disc due to a malfunction of the disc tray or a power failure. Do not use this method unnecessarily, since doing so will damage the CD-RW drive.

## Installing an optional card

### Available optional cards

By installing a separately sold mini-YGDAI card in a rear-panel slot, you can add analog input/output jacks to the AW2400 or allow connection of external digital devices. The following types of cards can be used.

Card type	Model	Number of channels	Digital format	Bit depth
AD card	MY4-AD	4	—	24 bit
	MY8-AD	8		20 bit
	MY8-AD24			24 bit
	MY8-AD96			24 bit
DA card	MY4-DA	4	—	20 bit
	MY8-DA96	8		24 bit
Digital I/O card	MY8-AE	8	AES/EBU	24 bit
	MY8-AE96			
	MY8-AE96S			
	MY16-AE	16	ADAT	
	MY8-AT	8		
	MY16-AT	16	TASCAM	
	MY8-TD	8		
MY16-TD	16			
Waves Plug-in DSP card	Y96K	8	ADAT	24bit
mLAN card	MY16-mLAN	16	IEEE1394	24bit

Refer to the Yamaha Pro Audio global website for the most recent information on I/O cards.

<http://www.yamahaproaudio.com>

### Installing an optional card

Before installing a card, you must check the Yamaha website to make sure that this device is compatible.

<http://www.yamahaproaudio.com>

To install an optional mini-YGDAI card, proceed as follows.

- 1 Make sure that the power is turned off.**
- 2 Loosen the screws that hold the slot cover in place, and remove the slot cover.**

Keep the removed slot cover in a safe place.

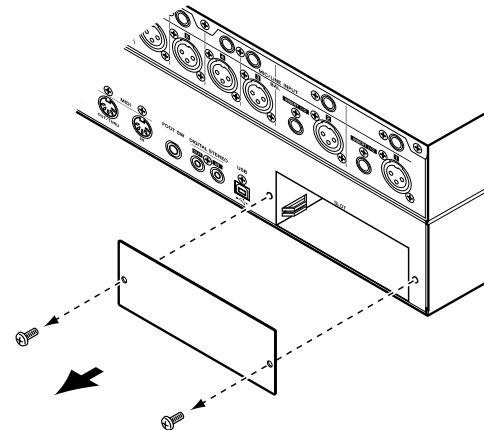

- 3 Align the edges of the card with the guard rails inside the slot, and insert the card into the slot.**

Push the card all the way into the slot so that the connector at the end of the card is correctly mated with the connector inside the slot.

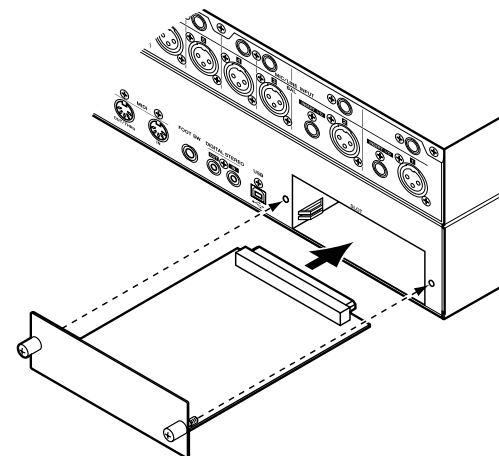

- 4 Use the screws included with the card to fasten the card in place.**

Malfunctions or incorrect operation may occur if the card is not fastened.

1

Before you start



# Introducing the AW2400

This chapter describes the features of the AW2400, the name of each part and its function, and introduces terminology you need to know when using the AW2400.

## Features of the AW2400

The AW2400 is an audio workstation that combines a digital mixer, multi-effect processor, hard disk recorder, and CD-RW drive.

The following diagram shows the signal flow within the AW2400.

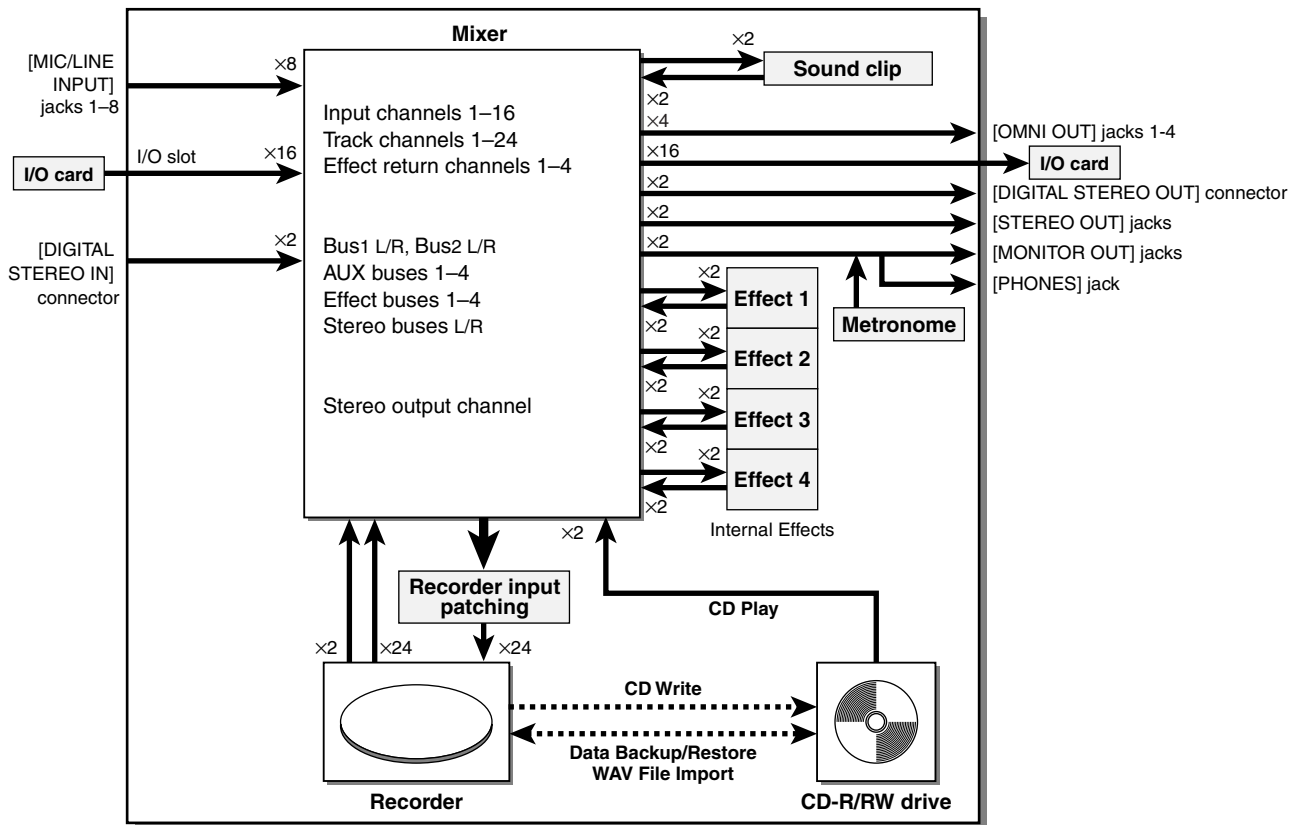

Now let's take a more detailed look at each section of the AW2400.

### ■ Mixer section

#### ● Plenty of input channels with professional features

The AW2400 digital mixer features 24-bit AD/DA conversion with 32-bit internal processing for uncompromised sound quality. 16 input channels, 24 track channels, and 4 stereo effect return channels provide plenty of input capacity for most mixing situations.

The 8 AD input ([MIC/LINE INPUT] jacks 1–8), channels 1–16 on an optional I/O card installed in I/O slot, or the stereo [DIGITAL STEREO IN] connector can be selected for input.

The track channel 1–24 inputs are permanently assigned to tracks 1–24, and the effect return channel 1–4 inputs are permanently assigned to the outputs of internal effect processors 1–4.

### ● **Totally redesigned operation**

The AW2400 is designed to be operated directly by the musician (guitarist, vocalist, drummer etc.). Input signal track assignment, mixdown and bounce recording settings, tracking with effects/EQ/dynamics, compressor settings, and much more can be easily handled with simple, straightforward operation.

### ● **Four-band EQ and dynamics processors on each channel**

Four-band full-parametric EQ and dynamics processing is provided on virtually every channel. You can recall the desired preset from the library, and use the panel knobs and keys to quickly adjust the settings.

### ● **Four high-quality multi-effect units built-in**

The four built-in effect units deliver a wide variety of effects including ambience effects such as reverb and delay, modulation type effects such as chorus and flanger, and guitar-type effects such as distortion and amp simulation. These effects can be used either via send/return, or inserted into a desired channel.

### ● **Automix capability**

Full automix production power is provided with 13 motor faders for comprehensive fader control, pan control, scene recall and library recall capability.

### ● **I/O slot for expansion with optional I/O cards**

Expanded inputs and outputs can be provided in ADAT, TASCAM, AES/EBU, and other formats. Optional DSP cards can also be used to provide extra signal processing capability via the I/O slot.

## ■ **Recorder section**

### ● **16-track Simultaneous Recording & 24-track Simultaneous Playback (16-bit songs)**

You can record multiple instrument tracks one by one, or set up multiple mics to record a drum set or a live performance by an entire band. A stereo track for direct mixdown of all 24 tracks is also provided, letting you manage the multi-track audio and the two-track mix as a single data package.

8 virtual tracks are available for the recorder tracks as well as the stereo track. When recording parts or when doing a mix, you can switch virtual tracks to record multiple takes and select the best take later.

The “bit depth” (number of quantization bits) of the audio data recorded on each track can individually be set to 16 or 24 bits for each song. 16-bit songs allow simultaneous recording of up to 16 tracks, and simultaneous playback of up to 24 tracks. 24-bit songs allow simultaneous recording up to 8 tracks, and simultaneous playback of up to 12 tracks (→ p. 165).

The recording sampling frequency can also be set to either 44.1 kHz or 48 kHz (the selected sampling has no effect on the number of simultaneous record or playback tracks).

### ● **Trigger track function**

The “Trigger Track” function allows the track [ON] keys and faders to be used to start and stop playback of recorded tracks. This is ideal for performance situations in which you want to switch phrases or patterns in real time, or when you need to start background music on cue, for example.

### ● **Versatile editing functionality**

Audio data recorded on a track can be copied, moved, or edited using a variety of commands. You can make detailed edits, or even make radical changes to the structure of the song by using the same riff repeatedly or increasing the number of choruses.

“Time Compression” lets you compress or expand the time axis of the audio data over a range of 50%–200%.

“Pitch Change” lets you modify the pitch over a range of up or down one octave. You can use the Undo function to undo the results of as many as the last fifteen editing operations.

### ● **A variety of Locate methods, and auto punch-in/out**

Eight locate points (start/end, relative zero, A/B, in/out, quick locator) and 99 markers can be assigned at any desired point in the song for quick access via Locate operations. Auto punch-in/out and A-B repeat playback functions are also provided. The AW2400 also has a metronome that follows the tempo map.

### ● **Sound Clip function**

The Sound Clip function lets you record and play back an input signal without using the recorder tracks. You can use this function to make quick sketches of song or arrangement ideas. You can transfer recorded sound clip data to the recorder as required.

### ● **Vocal Editing with Pitch Fix**

A Pitch Fix function is provided to allow precise adjustment of the pitch of a vocal track as well as the generation of chorus parts from a main vocal line. This feature can also be used to change the character of a vocal sound.



## ■ CD-RW drive

A dedicated CD-RW drive is installed in the AW2400. You can produce an audio CD containing the stereo mixes of songs recorded on the hard disk. Markers assigned within a song can also be used as the CD track numbers. You can even use advanced techniques such as assigning more than one track number within a single song. The CD-RW drive can also be used to backup/restore songs, to play back audio CDs, and to load WAV data from a CD-ROM.

## ■ Connecting to a Computer

The AW2400 can be directly connected to a computer via the built-in USB interface, which enables transferring audio files as well as MIDI messages. This allows WAV-format audio files to be copied between the AW2400 and computer for convenient management and processing in computer-based applications, and “backup” song files can be stored on the computer’s memory media.

# AW2400 terminology

Here’s a quick overview of terminology used with the AW2400.

## Recorder section

### ■ Tracks

A location where data is recorded is called a “track.” The AW2400’s recorder section uses the following types of track.

#### ● Audio tracks

The physical tracks used to record and play back audio data are called “audio tracks,” or simply “tracks.” The AW2400 has 24 audio tracks. You can record 16 tracks simultaneously, and play back 24 tracks simultaneously (16-bit songs).

#### ● Stereo track

The AW2400 has a “stereo track” that is independent from audio tracks 1–24, and which records and plays a stereo audio signal. The stereo track is used mainly as a dedicated mixdown track for recording the final mix.

#### ● Virtual tracks

Each of the 24 audio tracks and the stereo track consists of eight “virtual” tracks. For the audio tracks and the stereo track, only one virtual track can be recorded or played at any time. However, you can switch virtual tracks to continue recording other takes while preserving the previously-recorded content.

The diagram below shows the concept of virtual tracks. The horizontal rows indicate audio tracks 1–24, and the vertical columns correspond to virtual tracks 1–8. The shaded areas indicate the virtual track that is currently selected for recording or playback.

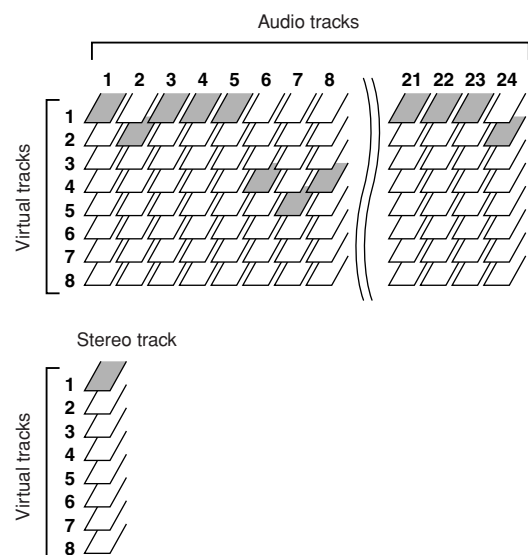

#### ● Trigger tracks

The “Trigger Track” function allows the track [ON] keys and faders to be used to start and stop playback of recorded tracks. When the Trigger Track function is engaged and you press a track channel [ON] key, the corresponding track will playback one time from the beginning of the song to the end of the recorded data.

## ■ Locate points/markers

Locations within a song that you specified in order to execute a function such as auto punch-in/out or A-B repeat playback are called “locate points.” Locate points include in/out points and the A/B points. You can use the Locate section keys to move instantly to these points.

You can assign “markers” at desired locations within a song independently of the locate points so that you can find these locations quickly. The AW2400 lets you set up to ninety-nine markers (1–99). By using the keys Locate section you can move instantly to the previous or next marker.

## Mixer section

### ■ Channels

A signal path that processes a single signal within the mixer and sends it to various sections is called a “channel.”

The mixer section of the AW2400 provides the following channels.

#### ● Input channels 1–16

Input channels provide level control, EQ, and dynamics processing for signals that are input via the [MIC/LINE INPUT] jacks 1–8, the [DIGITAL STEREO IN] connector, and/or an I/O card installed in the rear-panel slot, and send them to the recorder tracks or to the [STEREO OUT] jacks.

#### ● Track channels 1–24

These channels provide level adjustment, EQ, and dynamics processing for the audio playback signals from audio tracks 1–24 of the recorder, and send the signals to the stereo track and the [STEREO OUT] jacks. You can also perform “bounce recording” by sending these channels to different tracks.

#### ● Effect return channels 1–4

These channels send the signals returned from the internal effects to the stereo track and the [STEREO OUT] jacks.

#### ● Stereo output channel

This channel provides level adjustment, EQ, and dynamics processing for the stereo bus signal (which carries the mix of the other channels), and sends it to the stereo track or to the [STEREO OUT] jacks. The same signal is also output from the [MONITOR OUT] jacks and from the [PHONES] jack.

#### ● Bus master channels 1/2

Provide level adjustment, EQ, and dynamics processing for the signals from bus 1 and bus 2, and sends the signals to the audio tracks.

#### ● AUX send master channels 1–4

Provide final level adjustment for the AUX buses, as well as EQ and dynamics processing.

#### ● Effect send master channels 1–4

Provide final level adjustment for the effect buses, as well as dynamics processing.

## ■ Mixing Layers

In order to efficiently handle numerous input channels the AW2400 mixer section channels are organized in “mixing layers”. The diagram shows an overview of the AW2400’s 6 mixing layers.

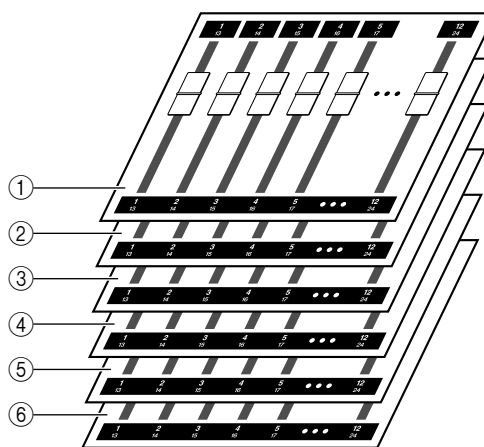

The channels available in each of the mixing layers are as follows.

#### ① Mixing Layer IN 1-8

Input channels 1–8 and effect return channels 1–4.

#### ② Mixing Layer IN 9-16

Input channels 9–16 and effect return channels 1–4.

#### ③ Mixing Layer MASTER

Bus master channels 1/2, AUX send master channels 1–4, and effect send master channels 1–4.

#### ④ Mixing Layer TRACK 1-12

Track channels 1–12.

#### ⑤ Mixing Layer TRACK 13-24

Track channels 13–24.

#### ⑥ REMOTE Layer

A special layer for remote control of external MIDI devices.

## ■ Mix Parameters

Channel pan, EQ, dynamics processor and other settings are known as “mix parameters”. All mix parameters can be saved together as “scenes” that can be recalled whenever necessary. Furthermore, specialized libraries are provided for various parameter groups – EQ, effects, etc. – that can be saved and recalled individually for each channel.

## ■ Paired channels

For effect return channels 1–4, stereo output channel, and bus master channel 1–2, the parameters (except for pan) are always linked for adjacent pairs of channels. These are called “paired channels.”

For input channels 1–16, track channels 1–24, and AUX send master channels 1–4, you can also assign adjacent odd-numbered/even-numbered channels to function as paired channels. The parameters (except for pan and phase) of paired channels will be linked, so that adjusting one parameter will cause the same parameter of the other channel to be adjusted accordingly.

## ■ Buses

A signal route that mixes the signals from multiple channels and sends them to an output jack or recorder track input is called a “bus.”

Unlike channels, which handle only a single signal, a bus can combine multiple signals into one or two (stereo) outputs and send them to a destination.

The AW2400’s mixer section provides the following buses.

### ● Stereo bus

This bus mixes the input signals to stereo, and sends them via the stereo output channel to the stereo track of the recorder or to the [STEREO OUT] jacks. Normally the same signal output via the [STEREO OUT] jacks is also output via the [MONITOR OUT] and [PHONES] jacks.

### ● AUX buses 1–4

These buses mix the signals from the track, input, and effect return channels and send them to the specified output connector. Use these when you will use an external effect processor, or to create a mix differing from the stereo channel for musicians to monitor.

### ● Effect buses 1–4

These buses combine the signals from the track and input channels, and input them to built-in effects 1–4.

### ● Bus 1, Bus 2

These buses mix track, input, and effect return channels and send them to the inputs of free tracks. Bus 1 and bus 2 are used for bounce (ping-pong) recording.

## Overall

### ■ Songs

The smallest unit by which the AW2400 manages a composition is called a “song.” When you save a song on the hard disk, all data necessary for reproducing that song will be saved; i.e., not just the audio data, but also the mixer settings and the automix settings. You can return to the original state at any time by loading the saved song.

### ■ Scenes and scene memories

A “scene” is a stored set of settings for the mixer section and effects. The area of memory that holds the scenes is called “scene memory,” and 99 scenes can be stored for each song. Scene memories are saved on the hard disk as part of the song.

### ■ Libraries

A “library” is an area of memory that stores individual settings such as for EQ or dynamics. The AW2400 has separate libraries for EQ, dynamics, effect, channel, and mastering settings.

Recalling a scene affects all mixer section settings, while the libraries allow only specified settings to be recalled as required. You can also save the settings from one channel and copy them to other channels, for example.

Each library is saved on the hard disk as part of the song.

### ■ Tempo map

The “tempo map” records changes in tempo and time signature that occur during the course of a song. The tempo map is saved on the hard disk as part of the song.

### ■ System data

Various global settings that apply to all songs are collectively referred to as “system data.” System data is stored on the hard disk independently of the individual songs.

# Parts of the AW2400 and what they do

This section explains the names and functions of the various items on the AW2400's top panel, rear panel, and front panel.

2

Introducing the AW2400

## Top panel

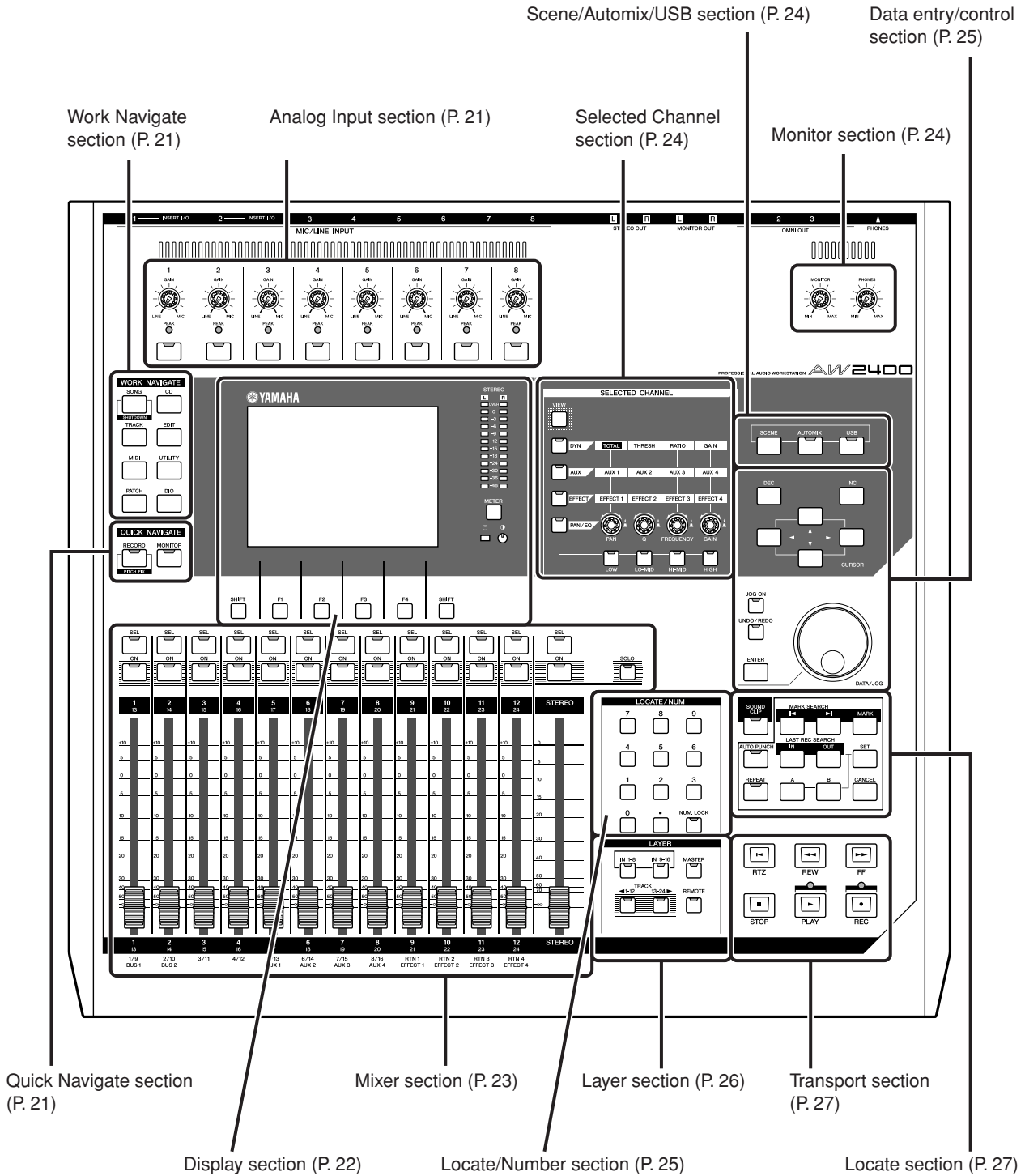

## Analog Input section

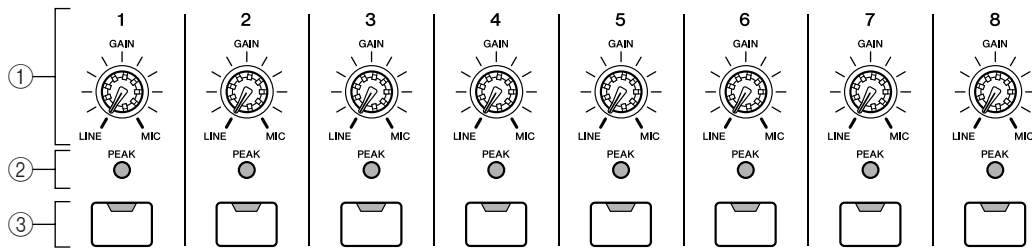

### ① [GAIN] knobs 1–8

These adjust the sensitivity of the rear panel MIC/LINE INPUT jacks 1–8 to input signals.

### ② [PEAK] Indicators

These indicators will light red if the peak signal level after the [GAIN] knob reaches or exceeds 3-dB below clipping. To set the optimum record level, set the [GAIN] knob so that the indicator flashes only briefly on the highest peaks that will be encountered during the recording.

### ③ [INPUT SEL] keys 1–8

These keys select the mixer input channel that you will operate.

## Work Navigate section

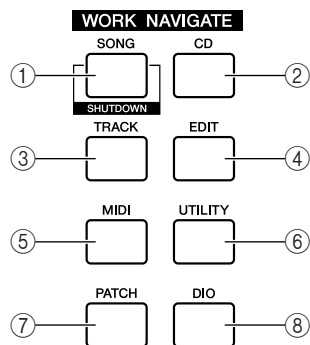

### ① [SONG] key

This key accesses the SONG screen, where you can save or load songs, and perform the shut-down procedure.

### ② [CD] key

This key accesses the CD screen, where you can write or play an audio CD, and backup or restore data.

### ③ [TRACK] key

This key accesses the TRACK screen, where you can check whether each track contains data, and switch the virtual tracks that will be used for recording and playback.

### ④ [EDIT] key

This key accesses the EDIT screen, where you can copy or erase tracks.

### ⑤ [MIDI] key

Accesses the MIDI screen where you can set up MIDI synchronization, scene change, and other settings.

### ⑥ [UTILITY] key

Press this key to access the UTILITY screen with settings for the unit's test tone oscillator, digital inputs and outputs, and other utility parameters.

### ⑦ [PATCH] key

Accesses the PATCH screen where you can patch output signals as required.

### ⑧ [DIO] key

The [DIO] key accesses the DIO screen which includes the clock source and I/O card settings.

## Quick Navigate section

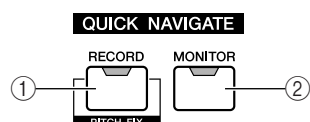

### ① [RECORD] key

This key accesses the RECORD screen, where you can quickly assign the signal to be recorded to the input of each track, and make settings for recording.

### ② [MONITOR] key

The MONITOR screen, accessed by this key, includes settings for fader grouping, the solo function, and more.

## Display section

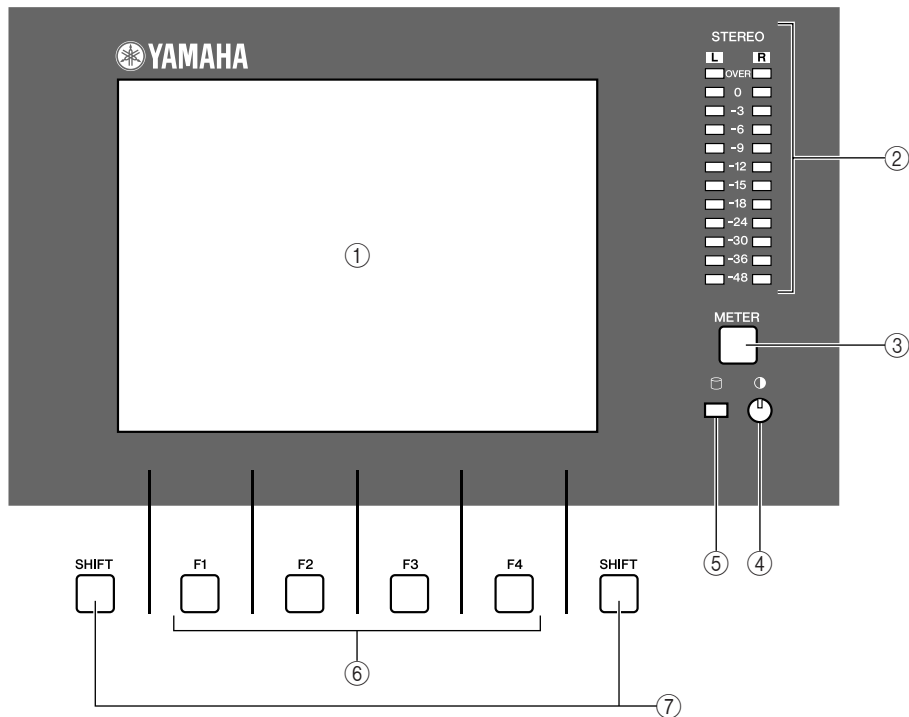

### ① Display

The backlit display screen provides easy visual access to all functions and parameters.

### ② Stereo Meters

These 12-segment levels meters show the final output signals levels on the stereo bus.

### ③ [METER] key

Calls the METER screen which includes the channel, bus, and other level meters.

### ④ Contrast

Adjusts the brightness of the display.

### ⑤ Access indicator

This indicator indicates the access status of the internal hard disk. When the hard disk is being read or written, this indicator will light.

### **⚠ CAUTION**

- Never turn off the power of the AW2400 when the access indicator is lit. Doing so will not only damage the data on the internal hard disk, but may also damage the hard disk itself. When you want to turn off the power of the AW2400, you must perform the shutdown procedure (→ p. 38).

### ⑥ [F1]–[F4] keys

These keys operate the “tabs” shown at the bottom of the display screen. They can access other pages in a group of functions, or in some cases execute specific functions.

### ⑦ [SHIFT] key

“Shifts” the function of the tabs at the bottom of the display to show additional functions, when applicable. “Shift functions” can be executed by pressing the appropriate functions key – [F1] to [F4] – while holding the [SHIFT] key.

## Mixer section

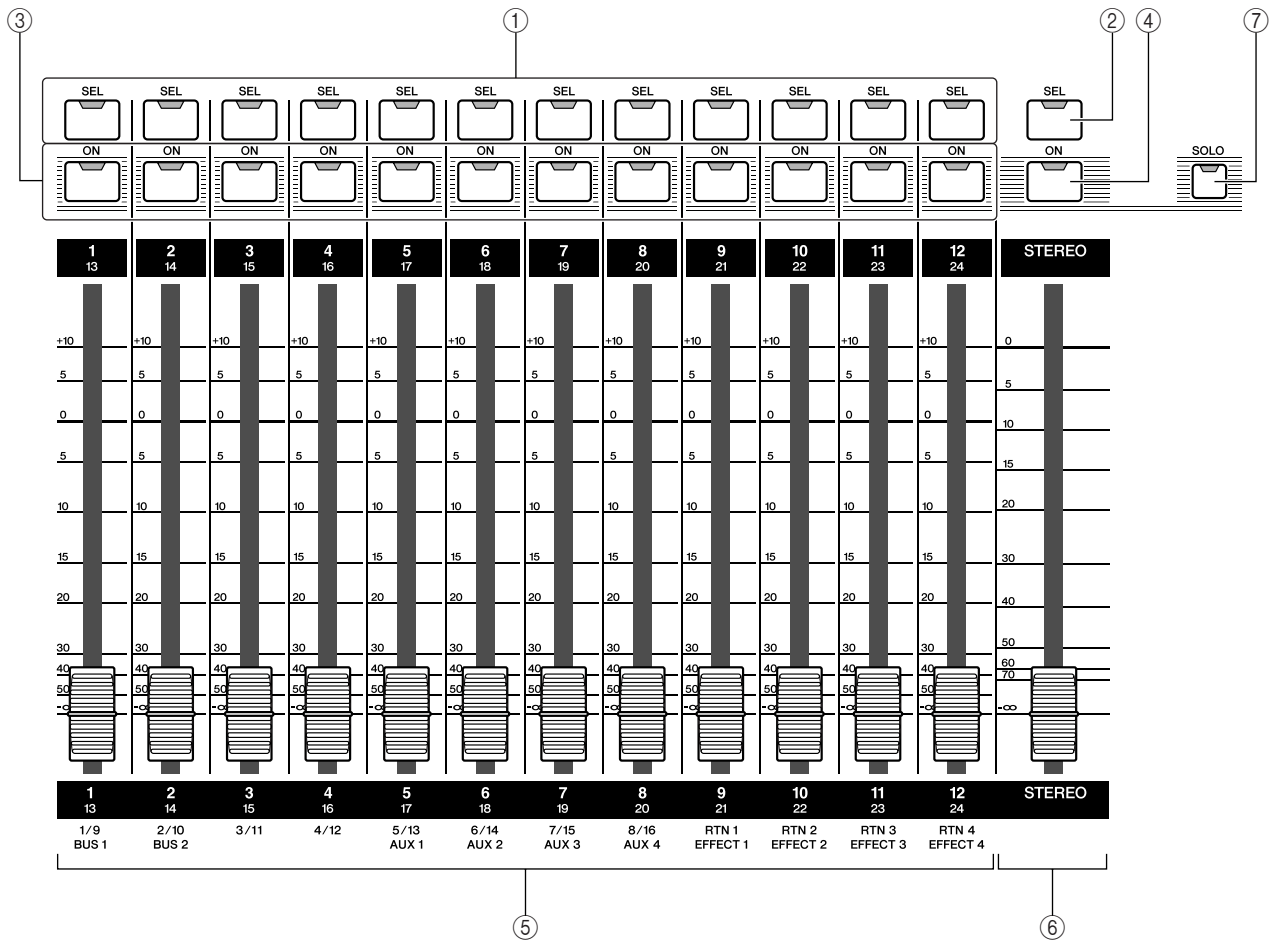

### ① [SEL] keys 1–12

### ② [STEREO SEL] key

Selects the channel to be operated. The [SEL] key of the currently selected channel will light.

### ③ [ON] keys 1–12

### ④ [STEREO ON] key

Turns the corresponding channel ON or OFF. The [ON] key will be lit when the corresponding channel is ON, and out when the channel is OFF. The [ON] keys are also used to specify solo channels when the solo function is on.

#### HINT

- When Trigger Track mode is engaged, the [ON] key can be used to start/stop playback of the corresponding track.

### ⑤ Faders 1–12

The faders adjust recorder track playback levels, input channel input levels, and effect return channel input levels according to the mixing layer currently selected via the LAYER section.

### ⑥ [STEREO] fader

Adjusts the output level of the stereo bus.

#### NOTE

- The [STEREO SEL] keys, [STEREO ON] keys, and [STEREO] faders always operate stereo channels. These keys and faders are not affected by the LAYER section settings.

### ⑦ [SOLO] key

Turns the solo function ON or OFF.

### Selected Channel section

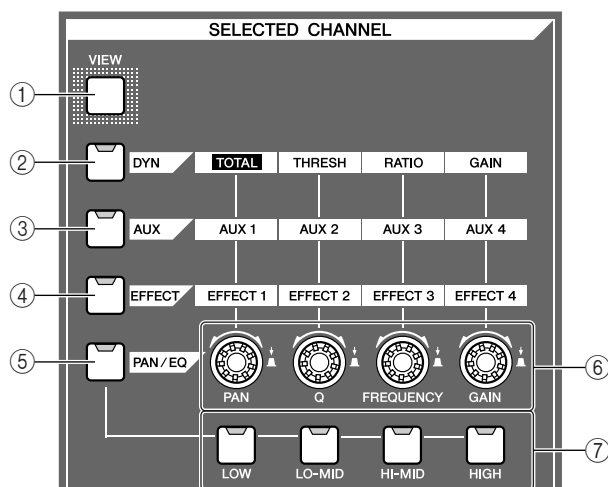

① **[VIEW] key**

This key accesses the CH VIEW screen, where you can check the level of each channel, or perform on-screen adjustments to the faders and other mix parameters of each channel.

② **[DYN] key**

Calls the DYNAMICS screen for the currently selected channel. You can then press any of the SELECTED CHANNEL knobs — 1 through 4 — to access the corresponding dynamics parameters.

③ **[AUX] key**

Calls the AUX screen for the currently selected channel. You can then press any of the SELECTED CHANNEL knobs — 1 through 4 — to access the corresponding AUX parameters.

④ **[EFFECT] key**

Calls the EFFECT screen for the currently selected channel. You can then press any of the SELECTED CHANNEL knobs — 1 through 4 — to access the corresponding EFFECT parameters.

⑤ **[PAN/EQ] key**

Calls the PAN/EQ screen for the currently selected channel. After pressing the [PAN/EQ] key, you can press any of the Selected Channel knobs 1 through 4 to switch the PAN/EQ screen pages.

⑥ **SELECTED CHANNEL knobs 1–4**

These knobs are used to adjust the various parameters for the selected channel. Press any of these knobs after pressing the [DYN], [AUX], [EFFECT] or [PAN/EQ] key to call the corresponding parameter screen.

⑦ **[LOW], [LO-MID], [HI-MID], and [HIGH] keys**

These keys specify the EQ band to be adjusted by the SELECTED CHANNEL knobs when the EQ screen EQ page is showing.

### Monitor section

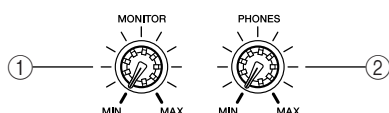

① **[MONITOR] knob**

This knob adjusts the level of the signal that is output from the [MONITOR OUT] jacks.

② **[PHONES] knob**

This knob adjusts the level of the signal that is output from the [PHONES] jack.

### Scene/Automix/USB section

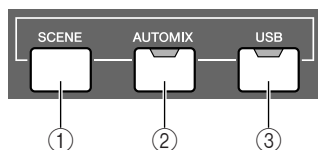

① **[SCENE] key**

This key accesses the SCENE screen, where you can save or recall scene memories.

② **[AUTOMIX] key**

This key accesses the AUTOMIX screen which allows control and editing of automix operations.

③ **[USB] key**

The [USB] keys calls up the USB screen with parameters related to USB operation.



## ■ Data entry/control section

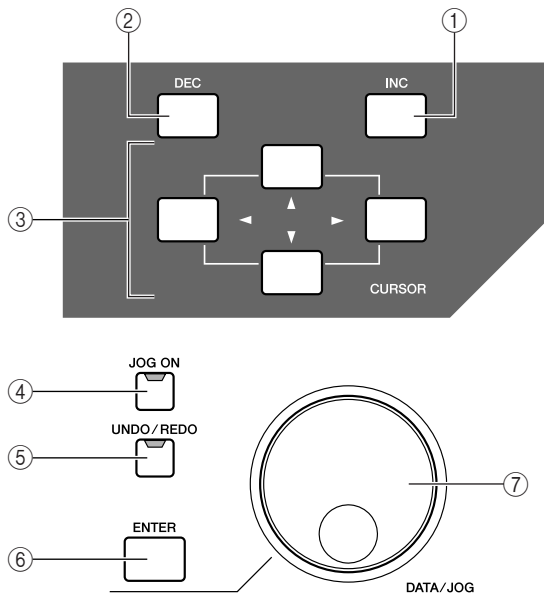

### ① [INC] key

Increments (increases) the selected value by 1.

### ② [DEC] key

Decrements (decreases) the selected value by 1.

### ③ [Cursor] keys ([▲]/[▼]/[◀]/[▶] keys)

These keys move the cursor (the blinking frame) around the screen to select a specific item.

### ④ [JOG ON] key

This key is an on/off switch for the Nudge function which uses the [DATA/JOG] dial. When this function is on, the key will light.

### ⑤ [UNDO/REDO] key

This key cancels the results of a recording or track editing operation (Undo), or re-executes a cancelled operation (Redo).



- This key will light if Undo is possible.

- If you press and hold this key, the UNDO LIST screen will appear. Here you can turn the [DATA/JOG] dial to revert to as many as the last fifteen operations (→ p. 64).

### ⑥ [ENTER] key

Use this key to operate an on-screen button, or to execute a specific function.

### ⑦ [DATA/JOG] dial

Use this dial to change the value of a parameter. If the [JOG ON] key is on, this dial operates the Nudge function.

## ■ Locate/Number section

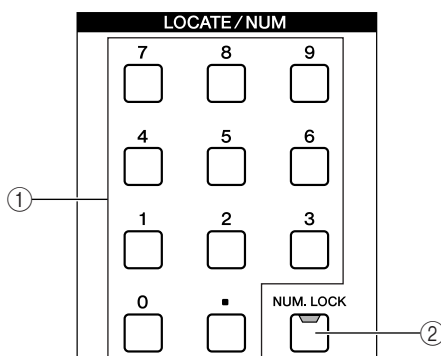

### ① [LOCATE] keys

These keys allow you to move directly to preset “locate” points. These keys are also used for character and number entry.

### ② [NUM.LOCK] key

This key allows you to specify a destination locate point in measures/beats.

## Layer section

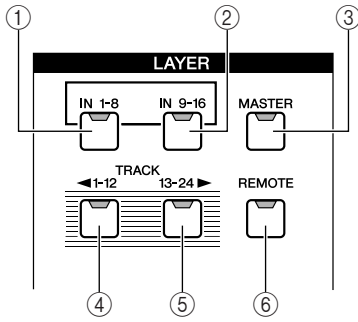

- ① [IN 1-8] key
- ② [IN 9-16] key
- ③ [MASTER] key
- ④ [TRACK 1-12] key
- ⑤ [TRACK 13-24] key

Select the mixing layer to be operated by the [SEL] 1–12 keys, the [ON] 1–12 keys, and faders 1–12. The mixing layers that can be controlled when each of these keys are engaged are as follows:

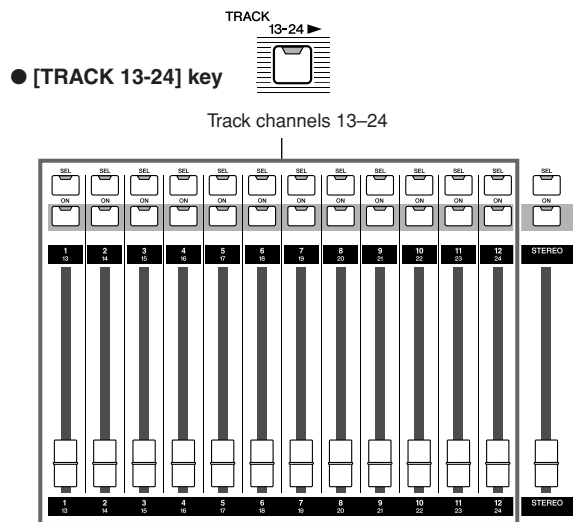
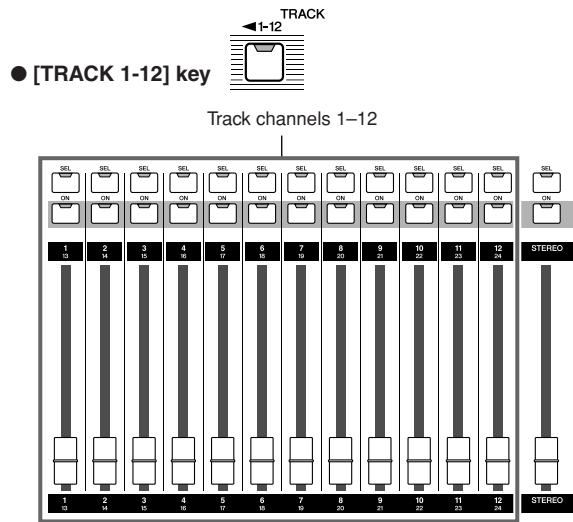
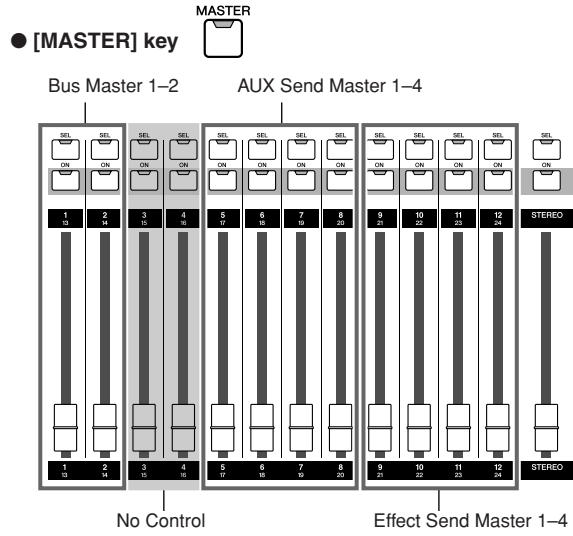
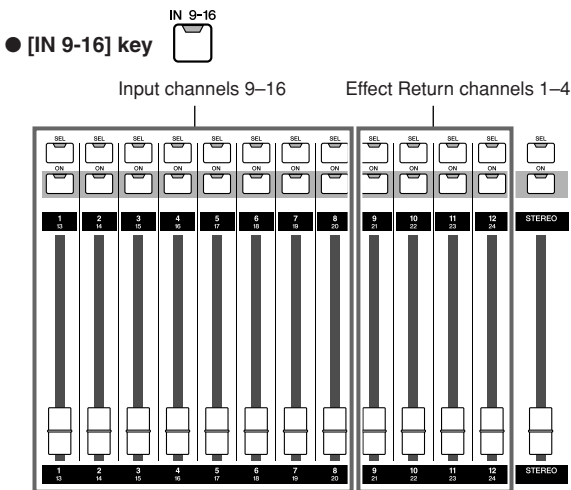
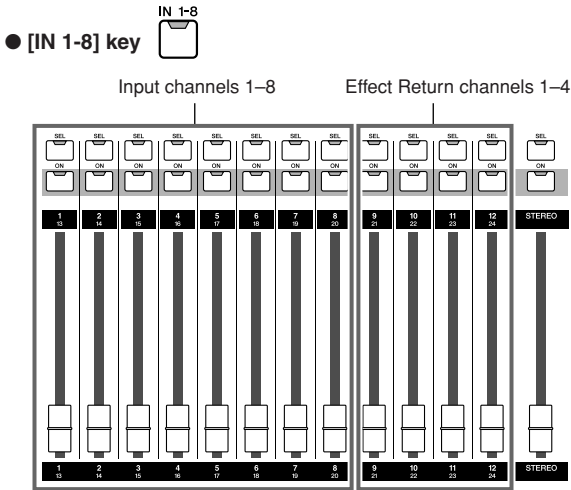

- ⑥ [REMOTE] key
- This key accesses the REMOTE screen, where you can use the front panel faders and [ON] keys to control an external MIDI device or sequencer software on your computer.

## Locate section

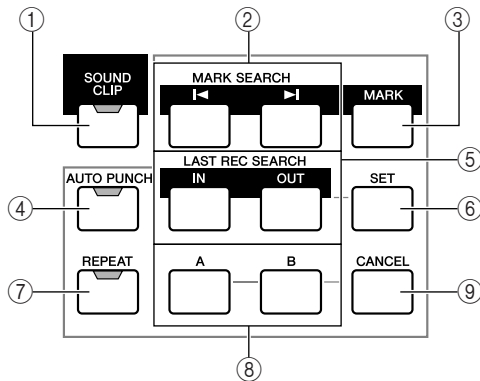

### ① [SOUND CLIP] key

This key accesses the SOUND CLIP screen, where you can record or play sound clips.

### ② MARK SEARCH [◀][▶] keys

These keys search for markers placed within the song.

### ③ [MARK] key

This key places a marker at the current location of the song.

### ④ [AUTO PUNCH] key

This key switches the audio punch-in/out function on/off, letting you automate recording.

### ⑤ [IN]/[OUT] keys

These keys specify the points at which auto punch-in/out recording will begin (the In point) and end (the Out point). These keys can also be used as locate keys to move directly to the In point or Out point.

### ⑥ [SET] key

Sets the in/out or A/B points in conjunction with the [IN]/[OUT], [A]/[B], and [LOCATE] keys. Also sets the relative zero time point when pressed simultaneously with the RTZ [◀] key.

### ⑦ [REPEAT] key

This key switches the A-B repeat function on/off, letting you repeatedly play a specified region.

### ⑧ [A]/[B] keys

These keys specify the points at which the Repeat function will begin (point A) and end (point B). These keys can also be used as locate keys to move directly to point A or point B.

### ⑨ [CANCEL] key

Use this key in conjunction with the [IN]/[OUT] keys, the [A]/[B] keys or the [LOCATE] key to cancel a locator that you registered.

## Transport section

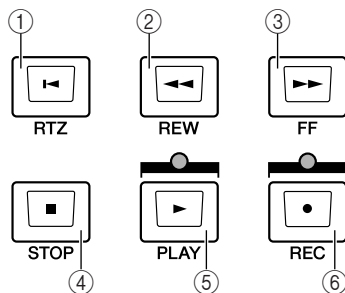

### ① RTZ [◀] key

This key moves directly to the absolute zero time location or the relative zero time location. Used in conjunction with the [SET] key, this registers the current location as the relative zero time.

### ② REW [◀◀] key

This key rewinds the song location. Press the key repeatedly to alternate between 8x speed and 16x speed. Press the STOP [■] key or PLAY [▶] key to stop rewind.

### ③ FF [▶▶] key

This key fast-forwards the song location. Press the key repeatedly to alternate between 8x speed and 16x speed. Press the STOP [■] key or PLAY [▶] key to stop fast-forward.

### ④ STOP [■] key

This key stops playback, recording, fast-forward, or rewind. Trigger track playback will also stop.

### ⑤ PLAY [▶] key

If you press this key while the recorder is stopped, playback will begin. If you press this key while holding down the REC [●] key, recording will begin. If you press this key during fast-forward or rewind, normal-speed playback will begin. If you press this key during recording, recording will stop and playback will resume (“punch-out”).

### ⑥ REC [●] key

If you hold down this key and press the PLAY [▶] key while the recorder is stopped, recording will begin. If you hold down this key and press the PLAY [▶] key during playback, you will switch from playback to recording (“punch-in”).

## Rear panel

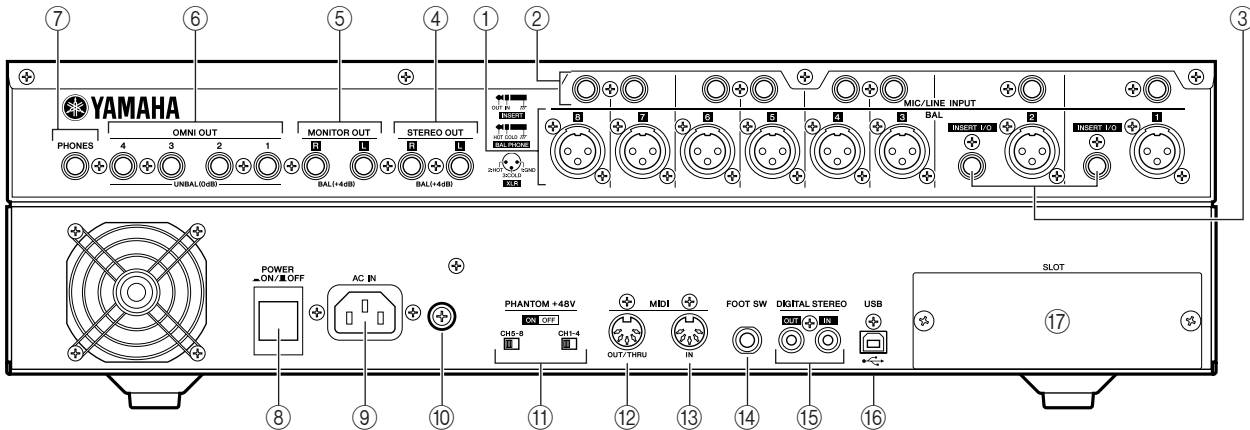

### ① [MIC/LINE INPUT] jacks 1–8 (XLR)

These are XLR-3-31 type balanced input jacks. Nominal input level is from -46 dBu to +4 dBu. Connector wiring is as shown below.

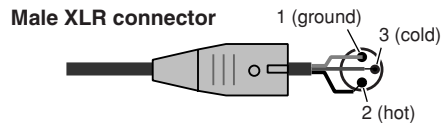

### ② [MIC/LINE INPUT] jacks 1–8 (TRS phone)

These are TRS phone type balanced input jacks. Nominal input level is from -46 dBu to +4 dBu. Connector wiring is as shown below.

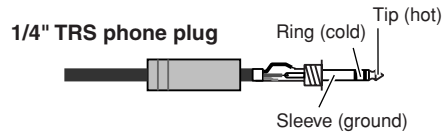

### ③ [INSERT I/O] jacks 1–2

These TRS phone jacks allow external signal processing gear to be inserted into the signal received at the [MIC/LINE INPUT] jacks 1–2. Nominal input level is 0 dBu, and the pin assignments are as follows:

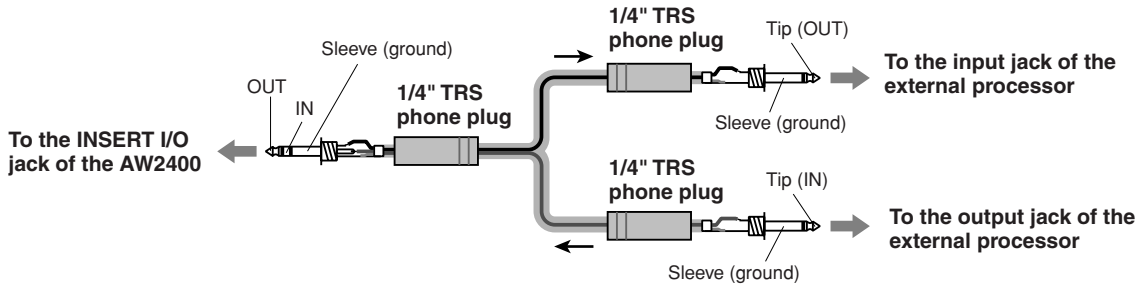

### ④ [STEREO OUT] jacks

These are TRS phone type balanced output jacks that output the signals of the stereo bus. Nominal output level is +4 dBu.

### ⑤ [MONITOR OUT] jacks

These are TRS phone type balanced output jacks that output the monitor signals of the stereo bus or the solo bus. Nominal output level is +4 dBu.

### ⑥ [OMNI OUT] jacks 1–4

The unbalanced phone jacks output the signals specified in the PATCH screen Output page. Nominal output level is 0 dBu.

### ⑦ [PHONES] jack

This is a 1/4 inch TRS phone output jack for connecting your headphones for monitoring. This jack always outputs the same signal as the [MONITOR OUT] jacks.

### ⑧ [POWER] switch

Switches the power ON and OFF.

#### NOTE

- When switching the power of the AW2400 ON or OFF, always follow the "Turning the power on/off" procedures described on page 38.

### ⑨ [AC IN] connector

Connect the supplied power cord to this connector.

#### CAUTION

- Use only the supplied power cord for this unit. The use of an inappropriate replacement may be a fire and electrical shock hazard.

### ⑩ Ground Screw

For maximum safety the ground screw should be properly connected to a confirmed ground point. Proper grounding will also ensure minimum hum, noise, and interference.

**⑪ PHANTOM +48V [CH1-4] and [CH5-8] switches**

Independent phantom power switches are provided for the XLR-type [MIC/LINE INPUT] jack groups 1 through 4 (CH1-4) and 5 through 8 (CH5-8). Turn phantom power to the appropriate jacks ON when using one or more phantom-powered condenser microphones.

**⚠ CAUTION**

- Be sure to turn the phantom power switches off when phantom power is not required.
- Make sure that no equipment other than phantom-powered microphones is connected to the XLR inputs of the input group for which phantom power is turned on. Applying phantom power to devices that are not phantom-powered can cause damage. Balanced dynamic microphones, however, can usually be connected without adverse effect.
- To prevent speakers damage turn power amplifiers (or powered speakers) off when switching phantom power on or off. It's also a good idea to turn all master faders and output volume controls down to minimum. The noise generated when phantom power is switched on or off can damage system components and may even cause hearing damage if amplified to sufficiently high levels.

**⑫ [MIDI IN] connector****⑬ [MIDI OUT/THRU] connector**

These connectors allow MIDI messages to be exchanged with external devices.

MIDI IN receives MIDI messages.

MIDI OUT/THRU can be internally switched to function either as a MIDI OUT (which transmits MIDI messages generated within the AW2400) or MIDI THRU (which retransmits messages that are received at the MIDI IN connector).

**⑭ FOOT SW jack**

An optional foot switch (Yamaha FC5) can be connected here to control transport operations such as start/stop, or to perform punch-in/out operations.

**NOTE**

- The appropriate operation may not occur if you use a foot switch other than the Yamaha FC5 (or equivalent).

**⑮ [DIGITAL STEREO IN/OUT] connectors**

This RCA pin jack allows digital-audio connection to external equipment via coaxial cable. The connector supports IEC-60958 consumer-format digital audio.

**⑯ USB connector**

This connector allows the unit to be directly connected to a USB-equipped computer via a standard USB cable (compatible with USB 2.0). When the USB Storage mode

is selected WAV files and song files can be transferred between the AW2400 and the computer. In the “normal” mode the USB connection can be used for MIDI control. The USB interface does not directly handle audio signals.

**NOTE**

- The USB interface cannot be directly connected to external hard disks or CD-R/RW drives.
- The AW2400 can be connected to either a USB 2.0 or USB 1.1 interface, but data transfer will be slower if a USB 1.1 interface is used.
- When connecting via USB 2.0 be sure to use a cable specified for USB 2.0 use.
- The USB MIDI driver provided on the supplied CD-ROM must be properly installed to allow MIDI message transmission and reception.

**Caution when using the USB connector**

You must observe the following points when connecting the AW2400 to your computer via the USB connector. If you fail to observe these points, your computer or the AW2400 may stop operating (“hang up”), causing data to be corrupted or lost. If the computer or the AW2400 stops working, turn the power off and then on again, and restart the computer.

- Before connecting the computer via the USB connector, disable the power management mode (suspend/sleep/standby/hibernate) on your computer.
- Connect the USB connector to the computer before you power-on the AW2400.
- Execute the following before turning the power to the AW2400 on/off, connecting/disconnecting the USB cable, or turning the USB Storage mode on/off.
  - Close all application programs.
  - If the USB Storage mode is off, make sure that data is not being transmitted from and to the AW2400.
  - If the USB Storage mode is engaged, make sure that no read or write operations are in progress.
  - If the USB Storage mode is engaged, safely remove the AW2400 from the Windows taskbar or drag the AW2400 icons from the Macintosh desktop to the trash after closing all AW2400 windows.
- Leave an interval of at least six seconds between powering the AW2400 on and off, or between disconnecting and connecting the USB cable.

**⑰ SLOT**

An optional card can be installed here.

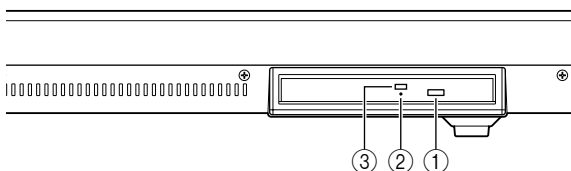
**Front panel****■ CD-RW drive****① Eject switch**

This switch ejects the disc tray.

**② Eject hole**

This hole allows you to open the disc tray manually.

**③ Access indicator**

This indicator will light while the CD inserted in the drive is being accessed.

# Basic operation of the AW2400

This section explains basic operation of the AW2400.

2

Introducing the AW2400

## Viewing the display

The display of the AW2400 shows the following information.

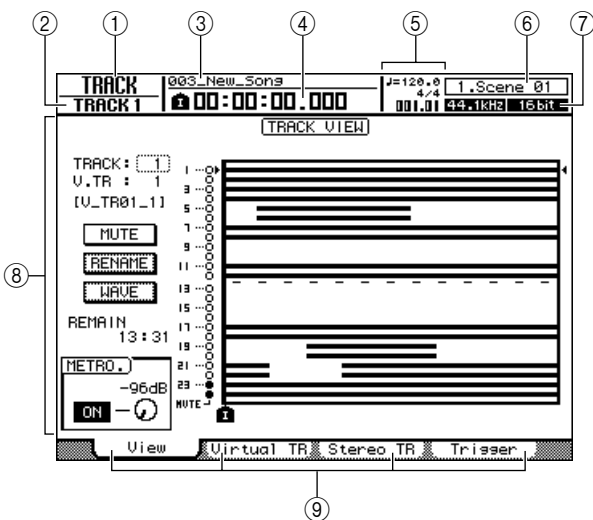

**① Screen name**

This is the name of the currently selected screen.

**② Selected channel**

This indicates the mixer channel that is selected for operation.

**③ Song name**

The name of the currently selected song.

**④ Counter (left side)**

This indicates the current location within the song. The current-time display format can be selected via the SONG screen Setting page. The choices are standard time (hours : minutes : seconds . milliseconds) or timecode (hours : minutes : seconds : frames . sub-frames)

**⑤ Counter (right side)**

This indicates the current location within the song in measures/beats. The measures/beats are calculated according to the tempo and time signature specified in the tempo map for the song. The current tempo and time signature are displayed above this value.

**⑥ Scene information**

The number and name (first eight characters) of the currently selected scene.

**⑦ Sampling Rate/Quantization Bits**

The sampling rate and quantization bits (bit depth) of the currently selected song.

**⑧ Main screen**

The information displayed in this area will depend on the key/knob that was last pressed. The following types of object are displayed in the main screen.

**● Cursor**

The blinking frame within the display is called the “cursor.” When an object in the screen is enclosed by the cursor, that object is selected for operation.



**● Buttons**

Buttons in the display are used to switch a parameter on/off, to select one of multiple choices, or to execute a specific function. A button that is currently on will be displayed in “inverse” form (black background with white text). A button that is currently off will be displayed in normal form (black text against a white background).



**● Knob/parameter display area**

The knob/parameter display area within the display is used to edit the value of the corresponding parameter.



Knob



parameter display area

**⑨ Tabs**

When a screen includes a number of pages, corresponding tabs will appear along the bottom of the display. The tabs are used to switch between the various pages related to the current screen.



In some cases the tabs also become “additional function buttons” when the [SHIFT] key is pressed. When additional functions are available an **F** mark will appear in the lower left corner of the display.

## Accessing a screen/page

When you want to edit an internal setting of the AW2400, or to edit a parameter that cannot be operated by a fader or knob on the top panel, you will need to access the desired screen and page.

### 1 Press the key or knob for the desired screen.

The keys and knobs of various sections listed below have their own screens, and the corresponding screen will be displayed when you press a key or knob.

- All keys in the Work Navigate section
- All keys in the Quick Navigate section
- The [METER] key in the Display section
- The [VIEW]/[DYN]/[AUX]/[EFFET]/[PAN/EQ] keys of the Selected Channel section
- All knobs of the Selected Channel section
- All keys of the Scene/Automix/USB section
- The [REMOTE] key of the Layer section
- The [SOUND CLIP] key of the Locate section



- Press a *SELECTED CHANNEL* knob after pressing the *SELECTED CHANNEL [DYN], [AUX], [EFFECT], or [PAN/EQ]* key to access the related display screen.
- When you switch screens, the page that was last used in that screen will be displayed.

### 2 Use the [F1]–[F4] keys to select different pages within a screen.

The [F1]–[F4] keys correspond to the tabs as follows.

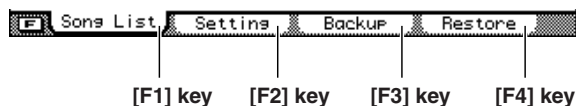

- You can access the pages in sequence by repeatedly pressing the key referred to in step 1, above.

## Switching a button on/off

Here's how to switch a button in the screen on/off.

### 1 Use the [CURSOR] keys to move the cursor to the desired button in the screen.



### 2 Press the [ENTER] key.

The button will be switched on/off. If you move the cursor to a button that executes a specific function and then press the [ENTER] key, that function will be executed.



## Editing a value in the display

Here's how to edit the value of a knob or parameter shown in the display.

### 1 Use the [CURSOR] keys to move the cursor to the desired knob or parameter value.



### 2 Turn the [DATA/JOG] dial or press the [INC]/[DEC] keys to edit the value.



## Using Additional Function Buttons

When an **F** mark appears in the lower left corner of the display the tabs shown along the bottom of the display can be switched to provide additional functions.

### 1 Press the [SHIFT] key when any screen with an **F** mark in the lower left corner is showing.

The additional function buttons will appear in place of the tabs along the bottom of the display while the [SHIFT] key is held.



Additional Function Buttons

### 2 While holding the [SHIFT] key press the [F1]–[F4] button to execute the corresponding function.

## Entering text

When you create a new song or save a scene memory or library setting, a popup window will appear allowing you to assign a name for the song or setting.

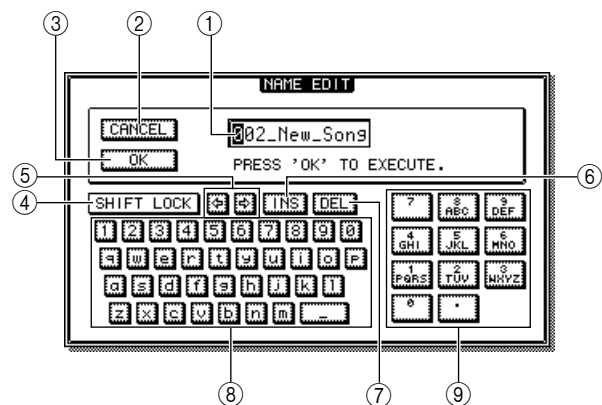

This popup window contains the following items and functions.

### ① Text input box

This box lets you input characters, numbers, and symbols. The character currently selected for editing is shown inverted (white on black). When you save the data for the first time, the box will contain a default name. The inverted highlight can be moved as required by using the [DATA/JOG] dial.

### ② CANCEL button

If you move the cursor to this button and press the [ENTER] key, you will return to the previous screen without changing the name.

### ③ OK button

If you move the cursor to this button and press the [ENTER] key, the scene/library will be saved or the new song will be created.

### ④ SHIFT LOCK button

Switches between upper or lower case characters, or the type of symbol to be entered at the current edit position in the text entry box.

### ⑤ [Left/Right Arrow] buttons

Move the inverted edit position left or right.



- The inverted edit position can also be moved left or right by using the [DATA/JOG] dial.

### ⑥ INS button

Inserts an under-bar space (“\_”) at the inverted edit position. All characters following the insert are moved to the right. Pressing the [INC] key has the same effect as the INS button.



- To add characters to a name that has less than the maximum number of characters, move the cursor to the INS button and press the [ENTER] key to insert “\_”, then change the name as required.

### ⑦ DEL button

Deletes the character at the inverted edit position. All characters following the delete are moved to the left. Pressing the [DEC] key has the same effect as the DEL button.

### ⑧ Text palette

This displays the characters, numbers, and symbols that can be input in the text input box. To enter a new character at the inverted edit position, move the cursor to the desired character in the text palette and press the [ENTER] key. The available characters and symbols are as follows:

A–Z a–z SPC(space) , . ! " # & / \* + - < > ; ;

### ⑨ Number Palette

Selects the number to be entered in the text entry box. To enter a number at the inverted edit position, move the cursor to the desired number in the palette and press the [ENTER] key.

By repeatedly pressing the [ENTER] key you can sequentially select and enter the characters displayed for each number button. For example, if you move the cursor to “1” in the number palette and then repeatedly press the [ENTER] key you will sequentially select the following number/characters for entry: 1 → P → Q → R → S → p → q → r → s → 1, and then the cycle repeats.

## ■ Using the [LOCATE] Keys To Enter Characters & Numbers

The [LOCATE] keys in the LOCATE/NUMBER section can be used to enter characters and numbers in the same way as the number palette. Repeatedly press the appropriate [LOCATE] key (0–9) to select the required number or character.

The numbers and characters selected by each key are as follows:

[LOCATE] Key Number	Selected Number/Character (Arrows indicate selection sequence)
0	0
1	1 → P → Q → R → S → p → q → r → s
2	2 → T → U → V → t → u → v
3	3 → W → X → Y → Z → w → x → y → z
4	4 → G → H → I → g → h → i
5	5 → J → K → L → j → k → l
6	6 → M → N → O → m → n → o
7	7
8	8 → A → B → C → a → b → c
9	9 → D → E → F → d → e → f



## Switching Mixing Layers

Switching mixing layers affects the functions of [ON] keys 1–12, [SEL] keys 1–12, and faders 1–12, allowing efficient control in a variety of signal-routing configurations. Remote control of external equipment is also possible.

Different mixing layers are selected via the keys in the LAYER section. The key corresponding to the currently selected mixing layer will be lit.

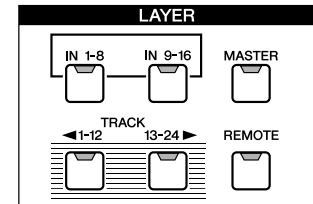

Layer Section

The mixer section controls correspond to the various mixing layers as follows:

LAYER Section Key	Fader Section												STEREO
	1	2	3	4	5	6	7	8	9	10	11	12	
[IN 1-8]	Input Channels 1–8								Effect Return Channels 1–4				Stereo Output Channel Control
[IN 9-16]	Input Channels 9–16								Effect Return Channels 1–4				
[MASTER]	Bus Masters 1–2		No Control		AUX Send Masters 1–4				Effect Send Masters 1–4				
[TRACK 1-12]	Track Channels 1–12												
[TRACK 13-24]	Track Channels 13–24												
[REMOTE]	*												

\* Operation depends on settings. Refer to page 204 for details.

For example, if the LAYER section [IN 1-8] key is engaged and the [SEL] 1 key is pressed, input channel 1 will be selected. If the LAYER section [TRACK 1-12] is then engaged and the same [SEL] 1 key is pressed, track channel 1 will be selected.



- The [STEREO SEL] key, [STEREO ON] key, and [STEREO] fader always control the stereo output channel. These controls are not affected by layer switching.

## Using the Selected Channel section

You can use the knobs and keys of the Selected Channel section to directly operate the mix parameters (EQ, dynamics, pan, etc.) of the currently selected channel.

### 1 Use the [SEL] keys or [STEREO SEL] key to select the channel that you want to operate.

The currently selected channel is indicated in the upper left of the screen. The channels correspond to each key as follows.

- [SEL] keys 1–12..... Input channels 1–16, Track channels 1–24, Effect Return channels 1–4
- [STEREO SEL] key ..... Stereo output channel



Currently selected channel.



- The channels to be selected by [SEL] keys 1–12 are switched via the LAYER section.

**2 Press the SELECTED CHANNEL section [DYN], [AUX], [EFFECT], or [PAN/EQ] key so that its indicator light, according to the parameters you want to control.**

With the default settings the screen corresponding to the pressed key will appear automatically. The display will not change if the UTILITY screen Preference page AUTO DISPLAY button is set to OFF (→ p. 211).

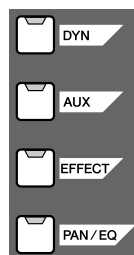

The parameters that can be controlled by the SELECTED CHANNEL knobs are as follows:

Selected Key (Lit)	Knob 1	Knob 2	Knob 3	Knob 4
[DYN]	Multiple compressor parameters, or the last parameter operated, depending on the control status.	Compressor threshold.	Compressor ratio.	Compressor gain.
[AUX]	Send level from channel to AUX 1.	Send level from channel to AUX 2.	Send level from channel to AUX 3.	Send level from channel to AUX 4.
[EFFECT]	Send level from channel to EFFECT 1.	Send level from channel to EFFECT 2.	Send level from channel to EFFECT 3.	Send level from channel to EFFECT 4.
[PAN/EQ]	Pan	Equalizer Q.	Equalizer frequency.	Equalizer gain.

**HINT**

- After selecting a channel, press the SELECTED CHANNEL [VIEW] key to call the CH VIEW screen where you can edit the channel signal routing and all of the channel parameters. Refer to page 105 for details on the CH VIEW screen.

**NOTE**

- The parameter controlled by SELECTED CHANNEL knob 1 when the [DYN] key is engaged depends on the current operating status (→ p. 153).
- If you operate SELECTED CHANNEL knob 1 immediately after recalling a setup from the compressor preset library, multiple compressor parameters will be adjusted simultaneously, changing the overall effect of the compressor (the type of change depends on the recalled preset library setup).
- When individual compressor parameters for a channel have been adjusted via the DYNAMICS screen, the last parameter adjusted is assigned to SELECTED CHANNEL knob 1 (the last-adjusted parameter is individually retained for each channel).

**3 Rotate SELECTED CHANNEL knobs 1–4 to adjust the corresponding parameters as required.**

If the UTILITY screen Preference page AUTO DISPLAY button is set to OFF, a popup window showing the corresponding parameter name and the value will appear while the knob is being operated.

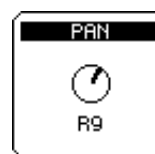

- 4** If you want more precise editing control over the parameter selected in step 2, above, press the corresponding **SELECTED CHANNEL knob (1–4)** to call up the screen containing the related parameters.

Selected Key (Lit)	Knob 1	Knob 2	Knob 3	Knob 4
[DYN]	DYNAMICS Screen	DYNAMICS Screen	DYNAMICS Screen	DYNAMICS Screen
[AUX]	AUX1 Screen	AUX2 Screen	AUX3 Screen	AUX4 Screen
[EFFECT]	EFFECT1 Screen	EFFECT2 Screen	EFFECT3 Screen	EFFECT4 Screen
[PAN/EQ]	PAN/EQ Screen	PAN/EQ Screen	PAN/EQ Screen	PAN/EQ Screen

**NOTE**

- The display will not change if the *SELECTED CHANNEL knob* is simply rotated. To switch screens the knobs must be pressed.
- Other gate functions can be accessed via the *DYNAMICS* screen, but only pages and parameters related to compressor operation can be accessed via the *SELECTED CHANNEL knobs*.

- 5** Move the cursor in the screen to the desired parameter, and use the [DATA/JOG] dial or the [ENTER] key to operate the parameter.

## 2

Introducing the AW2400

# ◆ Chapter 3 ◆

## Connection and Setup

This chapter will describe the AW2400 setup process from connection to instruments and other external equipment up to getting sound from a monitor system.

### Connection

The following connection diagram shows a typical AW2400 setup. Connect your microphones, instruments, and other external gear as shown in the diagram.

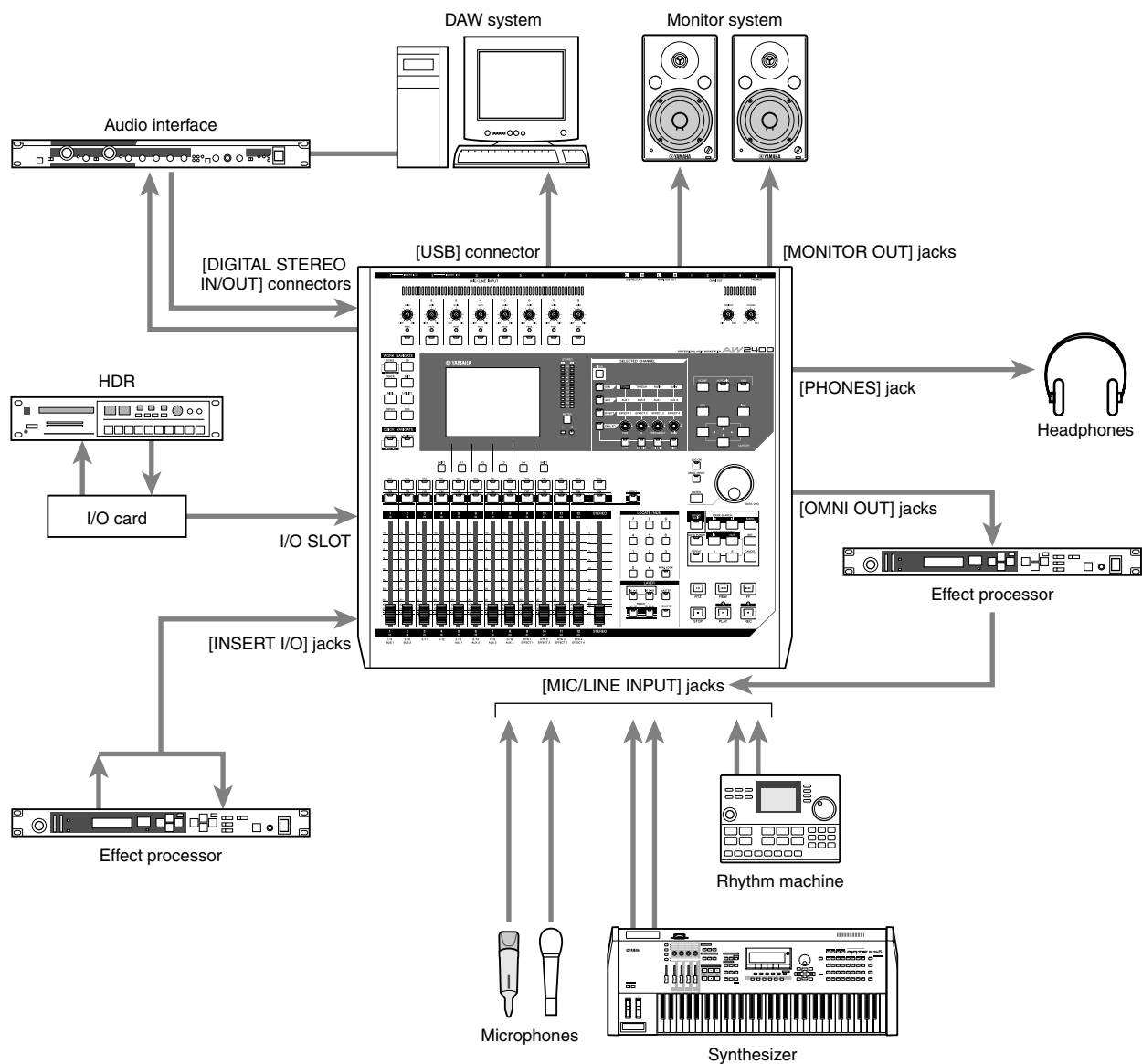

## Turning the power on/off

Follow the procedure outlined below when turning the AW2400 power ON and OFF. Failure to follow this procedure can result in damage to the internal hard disk or your external monitor system.

3

Connection and Setup

### Turning the power on

In a system that includes the AW2400, turn the power to each device on in the following order.

- ① External devices such as audio sources and effect processors connected to the input/output jacks of the AW2400
- ② The AW2400 itself
- ③ The monitor system connected to the AW2400's output jacks

#### CAUTION

- Before you turn on the power, make sure that the power cord is securely connected to the AW2400 and to the AC outlet. If the power is disconnected while the AW2400 is in use, the AW2400 or its internal hard disk may be damaged.

When you turn on the AW2400 power a startup screen will appear briefly, and then the following screen will appear.

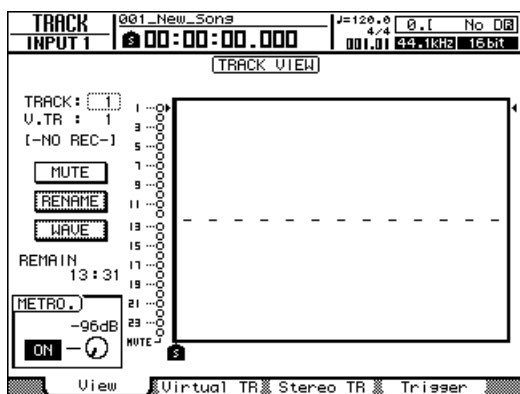

### Turning the power off (shut down)

In a system that includes the AW2400, turn the power to each device off in the following order.

- ① The monitor system connected to the AW2400's output jacks
- ② The AW2400 itself
- ③ External devices such as audio sources and effect processors connected to the input/output jacks of the AW2400

When turning the AW2400 power off, be sure to perform the following "shut-down" procedure.

- 1 Call the SONG screen Song List page by pressing the Work Navigate section [SONG] key located in the upper left of the top panel as many times as necessary.

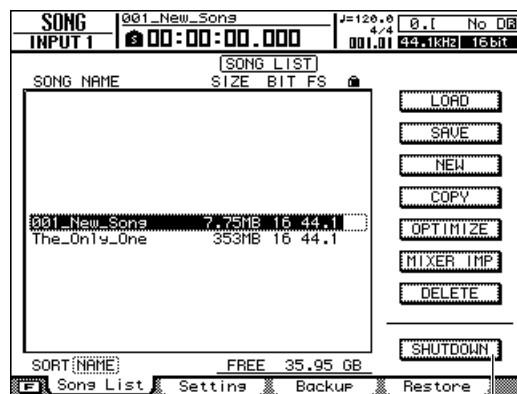

SHUTDOWN button

- 2 Using the CURSOR keys located in the upper right of the top panel, move the cursor (the blinking area in the screen) to the SHUTDOWN button.
- 3 Press the [ENTER] key located in the middle right of the top panel.  
A popup window will ask you whether you want to save the current song.



- 4 Move the cursor to the YES button if you want to save the current song, or to the NO button if you do not want to save it. Then press the [ENTER] key.
- 5 When the "Now safe to turn off..." message appears, turn off the [POWER] switch located on the rear panel.

#### IMPORTANT

- If you turn off the AW2400 power without performing the above shutdown procedure, not only will any unsaved changes be lost, but you also risk damaging the data on the hard disk, and damaging or drastically shortening the lifespan of the hard disk itself as well as the internal CD-RW drive. Please use caution.

## Adjusting the input level

Here's the basic procedure for setting up an input channel to which a microphone or instrument is connected via [MIC/LINE INPUT] jack 1–8, and adjusting the input level while monitoring the signal via the stereo bus.

**1 Turn down the [GAIN] knob for the [MIC/LINE INPUT] jack to which your instrument/mic is connected. Also lower the [STEREO] fader to the  $-\infty$  position.**

**2 Connect a microphone or instrument to the appropriate [MIC/LINE INPUT] jack.**

[MIC/LINE INPUT] jacks 1–8 can be used with the following sources.

● **[MIC/LINE INPUT (XLR)] jacks 1–8**

These are XLR-type balanced input jacks. Use a male XLR  $\leftrightarrow$  female XLR cable to connect your microphone, direct box, or a guitar/bass preamp that has a balanced output jack.

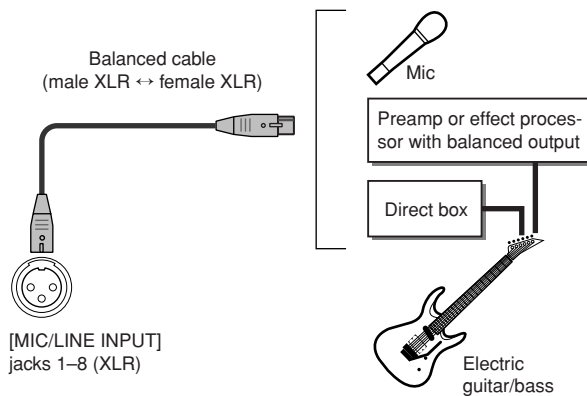

**HINT**

- When using condenser microphones or direct boxes that require phantom power, turn on the rear-panel [CH1-4] switch which supplies phantom power to [MIC/LINE INPUT] jacks 1–4, and/or the [CH5-8] switch which supplies phantom power to [MIC/LINE INPUT] jacks 5–8 as required.

● **[MIC/LINE INPUT (TRS phone)] jacks 1–8**

These are TRS-type balanced input jacks. Use a 1/4" TRS phone  $\leftrightarrow$  female XLR cable to connect your microphone, direct box, or a guitar/bass preamp that has a balanced output jack.

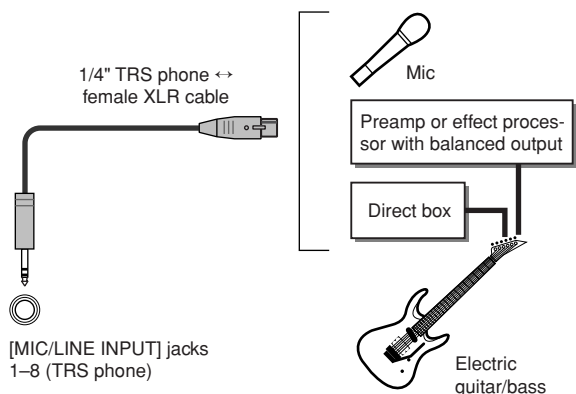

These connectors will also accept unbalanced output from instruments such as synthesizers or rhythm machines via standard mono 1/4" phone  $\leftrightarrow$  1/4" phone jack cables.

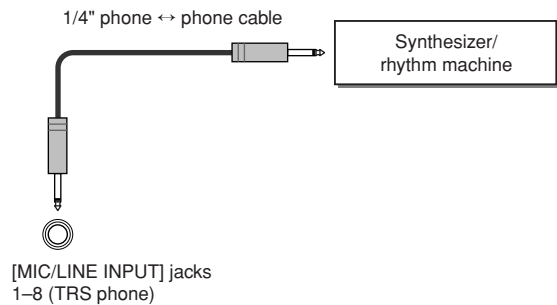

**NOTE**

- The XLR and TRS phone jacks for the same channel cannot be used simultaneously. Connecting sources to both inputs on the same channel at the same time can result in interference and a severely degraded input signal.

**3 While playing the connected instrument or supplying appropriate sound to the connected microphone, rotate the corresponding [GAIN] knob clockwise to adjust the input sensitivity so that the [PEAK] indicator lights only occasionally.**

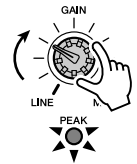

**HINT**

- The [GAIN] knobs adjust the gain (sensitivity) of the analog input stage. In order to make recordings with the greatest dynamic range and minimum noise, set the [GAIN] knob as high as possible without causing clipping.

**4** Call the **METER** screen **Input/RTN** page by either pressing the **Display** section **[METER]** key as many times as necessary, or by pressing the **[F1]** key after pressing the **[METER]** key.

The input channel input levels are displayed at the top of this screen.

Input channel input level display

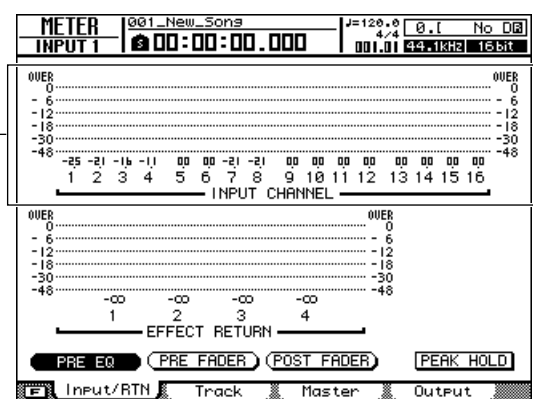

**5** Move the cursor to the **POST FADER** button in the lower area of the screen and press the **[ENTER]** key.

When the **POST FADER** button is turned on the signal levels immediately following the fader are displayed on the meters.

**6** Press the **Layer** section **[IN 1-8]** so that its indicator lights to switch to the **IN 1-8** mixing layer.

You can now use **[ON]** keys 1–8, **[SEL]** keys 1–8, and faders 1–8 to operate input channels 1–8.



- With the initial default settings the signals from **[MIC/LINE INPUT]** jacks 1–8 are assigned to the corresponding input channels 1–8. You can change these settings as required. Refer to “Direct recording and Mixed recording” on page 49 for details.

**7** Make sure that the **[ON]** key for the channel receiving the microphone or instrument signal is engaged and its indicator is lit, then raise the channel fader to the **0dB** position.

If you play the instrument or play into the microphone you should see the level meter on the display respond accordingly, but you won’t hear any output from your monitor system yet because the **[STEREO]** fader is still all the way down.

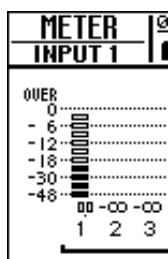

**HINT**

- If the level meter goes into the “**OVER**” region, check that the corresponding input fader is set to **0dB** and reduce the level of the **[GAIN]** knob.

**8** While playing the connected instrument, raise the **[STEREO]** fader to the **0 dB** position.

With the initial default settings the input channels are patched to the **AW2400**’s stereo bus. Signals sent to the stereo bus are output via the **[STEREO OUT]**, **[MONITOR OUT]**, and **[OMNI OUT]** jacks after being adjusted by the **[STEREO]** fader. When the **[STEREO]** fader is raised the level of the stereo bus signal will be displayed on the **Display** section stereo meter. You can now rotate the **[MONITOR]** or **[PHONES]** knob clockwise to hear sound from your monitor system or headphones.

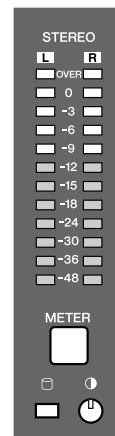

**NOTE**

- If the stereo meter does not respond even though the input channel level meter is showing the presence of a signal when the **[STEREO]** fader is raised, check that the input channel is patched to the stereo bus (→ p. 105).

That completes the initial setup and level adjustment procedure required to begin recording on the **AW2400**. Levels will have to be readjusted whenever you change the microphone or instrument input connections or change the output level of an instrument (level changes will often occur when you change synth patches). By using the **[GAIN]** knob to raise the level as far as possible without allowing distortion to occur, you can ensure that the input signal is converted into digital form with the highest possible quality before it is input to the mixer section.



# Listening to the demo song

When the AW2400 is shipped from the factory, its hard disk contains a demo song. This chapter explains how to load and play back the demo song.

## Loading the demo song

Here's how to load the demo song from the hard disk.

- 1 Press the Work Navigate section [SONG] key.**

The SONG screen will appear, where you can save or load songs.

- 2 Call the Song List page by either pressing the [SONG] key as many times as necessary, or by pressing the [F1] key after pressing the [SONG] key.**

In this page, you can select a song on the hard disk, and load or delete it.

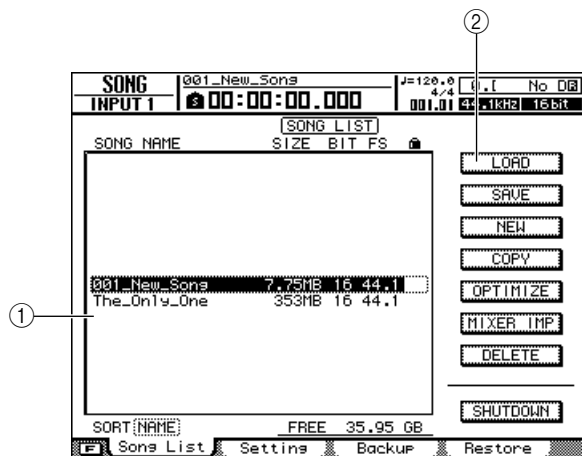

**1 Song list**

This area lists the songs that are saved on the hard disk. The line enclosed by the dotted frame in the center of the list indicates the song that is selected for operations. The highlighted line indicates the song that is currently loaded into the AW2400. (This is called the “current song.”)



- Each row of the list will display the song name, data size, bit depth (16/24 bit), and sampling rate (44.1/48 kHz).

**2 LOAD button**

Loads the selected song.

- 3 Move the cursor to the song list, and then use the [DATA/JOG] dial or [INC]/[DEC] keys to select the song “The\_Only\_One.”**

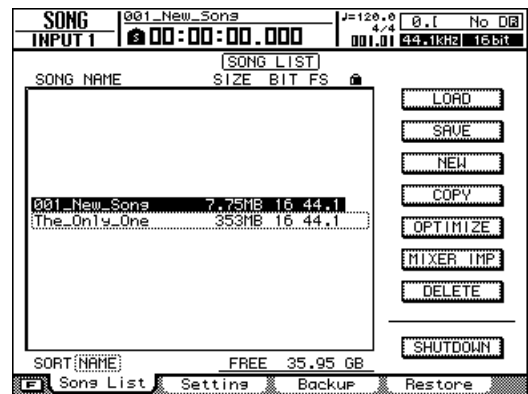

- 4 Move the cursor to the LOAD button in the screen, and press the [ENTER] key.**

A popup window like the following will appear. This window asks you whether you want to save the current song.



- 5 Move the cursor to either YES (save the current song) or NO (don't save the current song), and press the [ENTER] key.**

The song data will be loaded, and “The\_Only\_One” will become the current song.



- If you select NO, any changes that you made to the current song since you last saved it will be lost.

“You're the Only One”  
© Timothy Akers

## Playing the demo song

Here's how to play back the demo song you loaded, and adjust the monitor level.

**1** Make sure that the AW2400's [MONITOR] knob, [PHONES] knob, and the volume of your monitor system are turned down.

**2** Press the PLAY [▶] key.

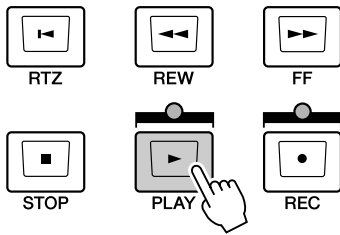

The demo song will begin playing.

**3** To adjust the monitor level appropriately, use the AW2400's [MONITOR] knob, [PHONES] knob and the volume control of your monitor system.

**HINT** →

- The demo song uses the Scene function to switch the settings of the mixer. This means that playback will occur using the pre-specified balance — you do not need to operate the faders.

**4** To stop the song, press the STOP [■] key.

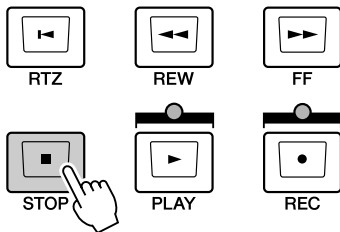

# Recording to a sound clip

The AW2400 has a Sound Clip function that lets you record and play back independently of the recorder section. You can use a sound clip to quickly record and play back your performances on an audio source connected to the AW2400. This is an ideal way to capture ideas for a song or arrangement, or to record a simple accompaniment for practicing a part.

This chapter explains how sound clips can be recorded using an instrument or microphone connected to an input jack.

## Recording a sound clip

The post-fader signal of the stereo output channel can be recorded directly to a sound clip. For playback, the signal will be sent to the stereo output channel immediately before the stereo fader (EQ and dynamics cannot be applied to sound clip playback).

● Signal flow when using a sound clip

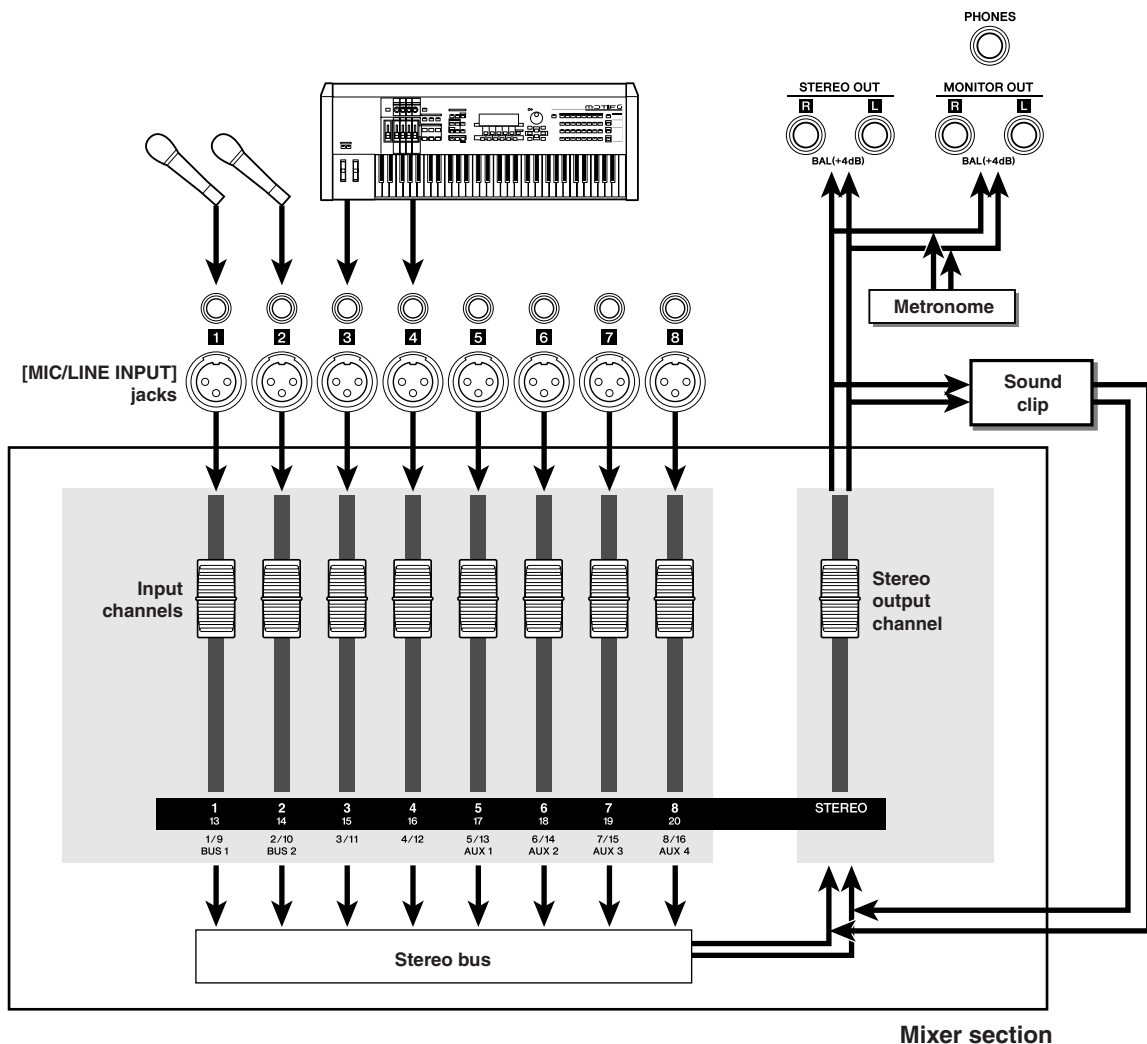

**1** Connect the required instrument and/or microphone input sources and set up the levels as described in “Connection and Setup” on page 37.

**2** Press the Locate section [SOUND CLIP] key.

The SOUND CLIP screen will appear, where you can record and play sound clips.

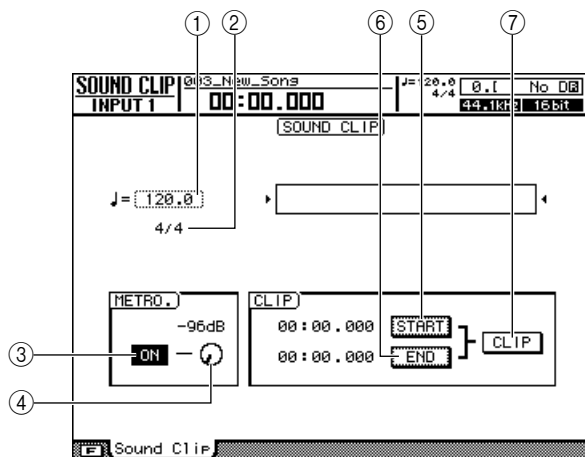

**1 Tempo**

Sets the tempo of the metronome used when recording sound clips.

**2 Time signature**

Shows the time signature of the metronome.

**3 Metronome button**

Switches the metronome on/off.

**4 Metronome knob**

Adjusts the volume of the metronome. The value above the knob shows the current setting in dB.

**5 START button**

Specifies the current location as the start point of the sound clip (the location at which playback will begin). The current location is shown in minutes/seconds/milliseconds to the left.

**6 END button**

Specifies the current location as the end point of the sound clip (the location at which playback will end). The current location is shown in minutes/seconds/milliseconds to the left.

**7 CLIP button**

Turn this button on to enable the START button (5) and END button (6) settings.

**NOTE**

- The Recorder section cannot be used for recording and playback while the SOUND CLIP screen is showing.

**3** To use the metronome, move the cursor to the metronome button and press the [ENTER] key.

**4** To change the tempo of the metronome, move the cursor to the tempo value and turn the [DATA/JOG] dial.

**NOTE**

- The time signature of the metronome is determined by the tempo map setting that was active prior to accessing the SOUND CLIP screen. Please be aware that the setting cannot be edited from this screen. (For details on tempo map settings → p. 62)

**5** Hold down the Transport section REC [●] key and press the PLAY [▶] key.

The metronome will start and the counter display will advance. The SOUND CLIP screen counter always starts from 0 and indicates the current time in minutes/seconds/milliseconds. This counter is separate from the normal song counter.

**6** Play the part to be recorded in time with the metronome.

**HINT**

- The metronome sound will not be recorded. If necessary, you can move the cursor to the metronome knob and turn the [DATA/JOG] dial to adjust the volume of the metronome sound.
- The knobs/keys of the selected channel are active even while the SOUND CLIP screen is showing. If necessary, you can apply EQ and dynamics processing to the signal being recorded.

**7** Press the STOP [■] key to stop recording.

S and E symbols on the display indicate the start and end point.



**HINT**

- With the default AW2400 settings a maximum of 30 seconds can be recorded to a sound clip. If you continue recording for longer than 30 seconds, the last 30 seconds recorded will be retained (the counter display during recording will continue to advance).
- You can specify up to 180 seconds as the maximum length that can be recorded in a sound clip. You are free to make this setting before creating a new song, but this cannot be changed once the song has been created. (→ p. 47)

## Playing a sound clip

### 1 Press the PLAY [▶] key to hear the recorded sound clip.

The sound clip will play repeatedly from the start point to the end point. To stop playback press the STOP [■] key. If you record again, the previous data will be overwritten.

The Transport section keys will have the following functions while the SOUND CLIP screen is showing.

Key	Function
RTZ [◀] key	Returns to the location at which you began recording. If the CLIP button is on, this returns to the Start point.
REW [◀◀] key	Rewinds the current location toward the beginning. You will stop when you reach the location at which you began recording or the Start point.
FF [▶▶] key	Fast-forwards the current location. You will stop when you reach the location at which you stopped recording or the End point.
STOP [■] key	Stops playback, recording, rewind, or fast-forward.
PLAY [▶] key	Starts playback. Pressing this key during playback does nothing.
REC [●] key	If you hold down this key while stopped and press the PLAY [▶] key, recording will begin. Pressing this key during playback does nothing.



- You will not hear the metronome while a sound clip is playing, but you can still monitor the signals of input channels 1–16.

### 2 The playback region of a sound clip can be changed by specifying new Start and End points as described below.

#### ● Specifying the Start point

Stop at the location that you want to specify as the Start point, move the cursor to the START button, and press the [ENTER] key.

The START button will be engaged and the current location will be registered as the Start point.

#### ● Specifying the End point

Stop at the location that you want to specify as the End point, move the cursor to the END button, and press the [ENTER] key.

The END button will be engaged and the current location will be registered as the End point.

### 3 Stop playback, move the cursor to the CLIP button, and press the [ENTER] key.

The CLIP button will be engaged, and the specified Start point and End point will be enabled.



- The START button, END button, and CLIP button are disabled while the sound clip is playing.



- The data region between the specified Start and End points can be copied to an audio track of the Recorder section by using the EDIT screen COPY command (→ p. 139).

### 4 To exit the SOUND CLIP screen, press the Work Navigate section (except for [PATCH] key) or Quick Navigate section keys, [AUTOMIX] key, [USB] key, [REMOTE] key, or [SOUND CLIP] key.

A popup window will ask you for confirmation. Move the cursor to the OK button to exit the SOUND CLIP screen, or to the CANCEL button to cancel, then press the [ENTER] key.

You can return to the SOUND CLIP screen by pressing the [SOUND CLIP] key even after having exited the screen, then play back the previously recorded content or record a new performance.



- When you record a new sound clip, the previous recorded sound clip will be erased. Please be aware that the Undo function cannot be used to recover a deleted sound clip. Even if you save the song immediately prior to recording a new sound clip, the previous sound clip will not be restored if you recall the song data.



- The recorded contents of the sound clip are stored individually for each song.

5

Recording to a sound clip

# Track recording

This chapter explains how to record the audio signal from an instrument or microphone connected to the AW2400 to the tracks of a song.

## Creating a new song

Before you can begin recording on the AW2400 you need to create a new song.



- When you start up the AW2400 for the first time, an empty song will be loaded automatically. If you use this automatically-loaded song, the procedure described here is not necessary.

**1** Call the SONG screen Song List page by either pressing the Work Navigate section [SONG] key as many times as necessary, or by pressing the [F1] key after pressing the [SONG] key.

The currently selected song in the Song List will be highlighted (inverted).

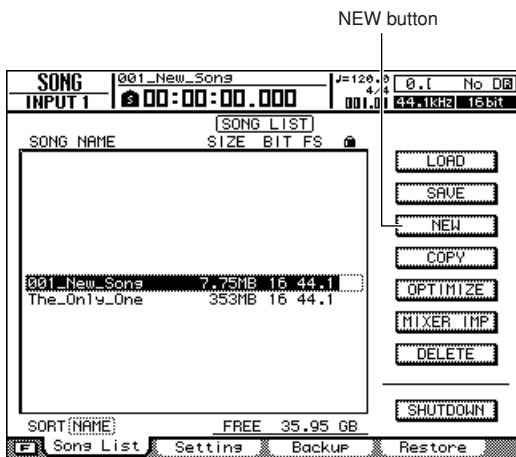

**2** Move the cursor to the NEW button and press the [ENTER] key.

A popup window will ask you whether you want to save the current song.

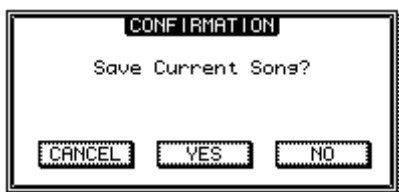

**3** Move the cursor to YES (to save the current song) or NO (if you don't want to save the current song) and press the [ENTER] key.

A popup window containing the various settings for the new song will appear.

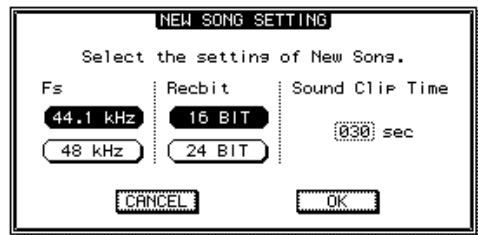

The following settings can be made via this popup window.

- **Fs** ..... The sample rate of the new song can be set to either 44.1 kHz or 48 kHz.
- **Recbit** ..... The bit depth of the new song can be set to either 16 or 24 bits.
- **Sound Clip Time** ..... The sound clip record time can be set to between 30–180 seconds.



- Songs recorded with a sampling frequency of 48 kHz cannot be written to an audio CD.

**4** When each parameter has been set as required, move the cursor to the OK button and press the [ENTER] key.

Next, a popup window will appear allowing you to specify settings that will be carried over from the current song.

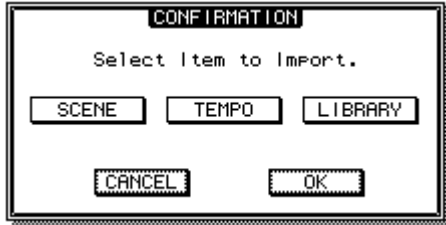

The following items are available:

- **SCENE button**.....Scene memories
- **TEMPO button** .....Tempo map
- **LIBRARY button** .....EQ, dynamics, effects, and channel libraries

For example, if you have saved effect settings in a library for the current song and would like to use these settings for the new song as well, you would turn on the LIBRARY button.

**5** Select the buttons of the items you want to carry over from the current song, move the cursor to the OK button, and press the [ENTER] key.

The NAME EDIT popup window will appear, allowing you to enter a name for the song.

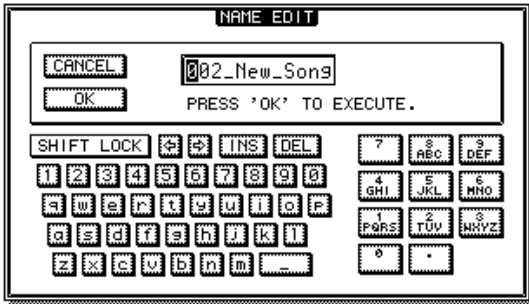

**6** Enter a name for the song (for details on name entry refer to page 32).



- A new song cannot be given the same name as an existing song.
- The song name can also be edited later (→ p. 169).

**7** To create the new song, move the cursor to the OK button and press the [ENTER] key.

A new song will be created, and you will return to the SONG screen Song List page.

If you move the cursor to the CANCEL button (instead of the OK button) and press the [ENTER] key, you will return to the SONG screen Song List page without creating a new song.



# Direct recording and Mixed recording

Instruments and/or microphones connected to the AW2400 can be recorded to tracks in one of the following two ways.

## ■ Direct recording

With this method only one input channel is assigned to each recorder track. Although direct recording requires the same number of tracks as the number of input channels you use, it has the advantage that you will be free to adjust the volume, pan (stereo position), and EQ of each individual instrument after it has been recorded.

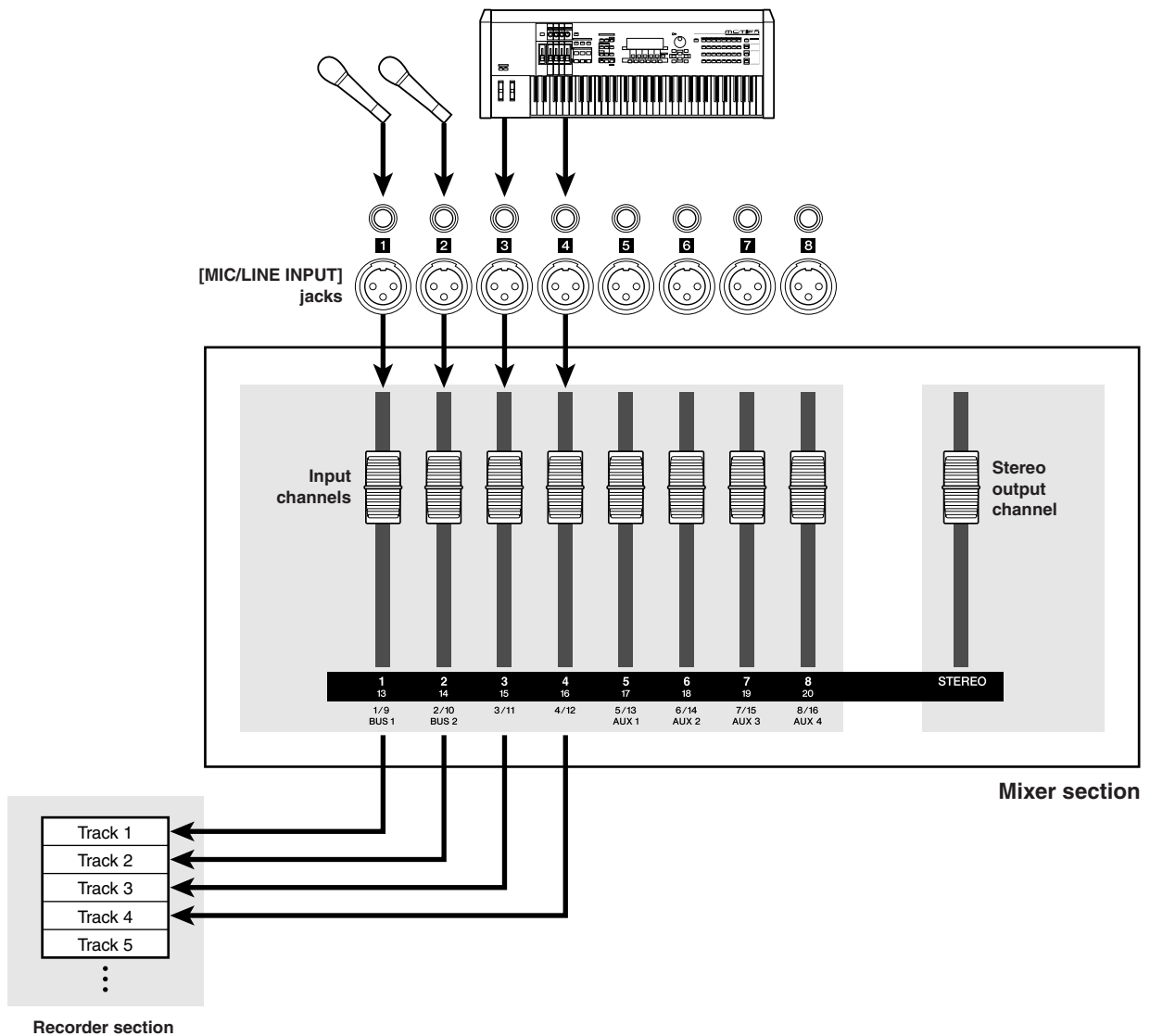

## Mixed recording

With this method, you can send multiple input channels to Bus 1 or Bus 2, and assign the mixed signal to one through four tracks. Mixed recording requires fewer tracks, but you will need to decide on the final volume, pan, and tone of each instrument at the time of recording (you will not be able to adjust these parameters independently after recording.)

6

Track recording

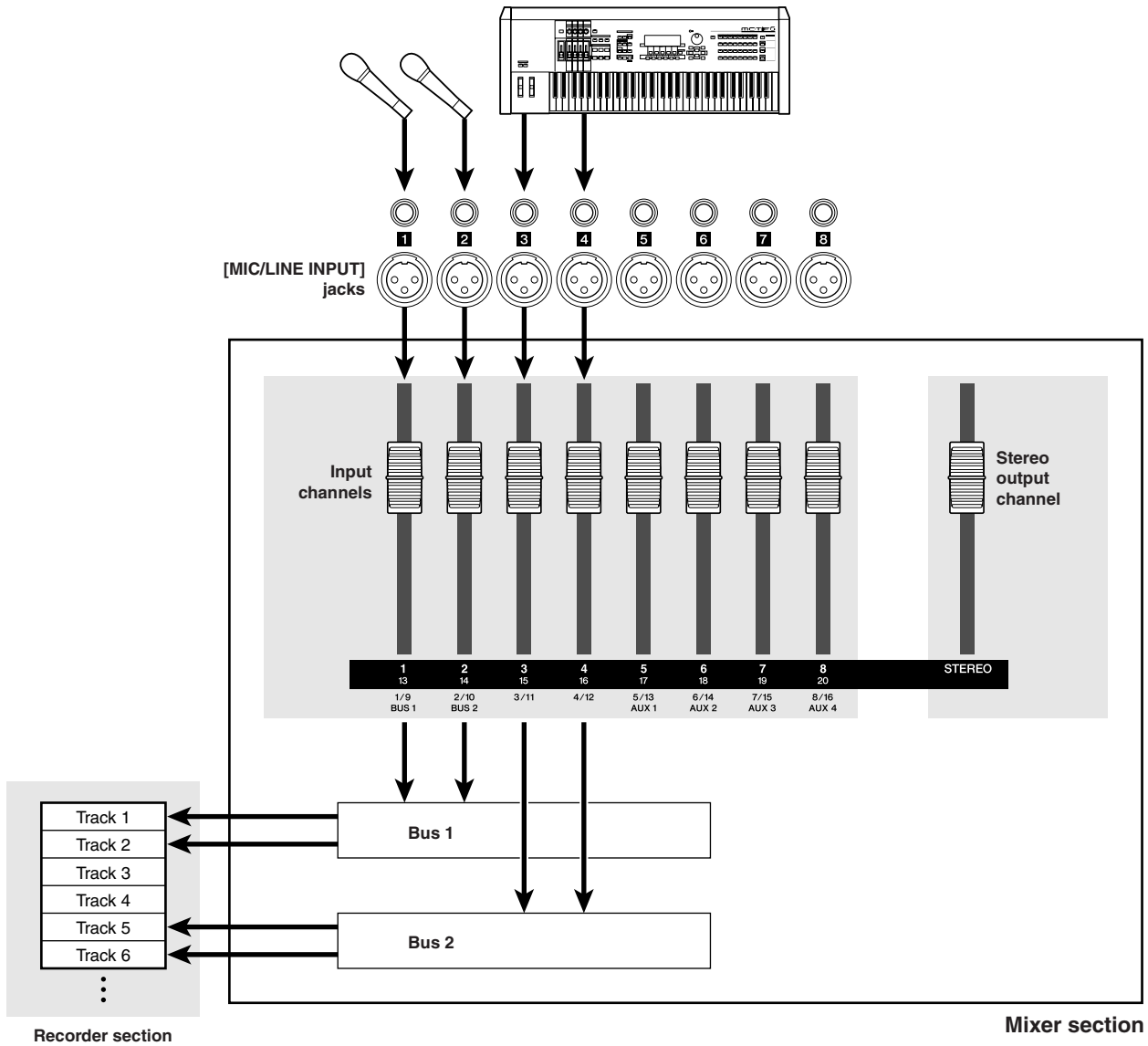

**NOTE**

- The way in which you assign the input signals to tracks will depend on the method you choose.

## Assigning input signals to tracks (Direct recording)

This section describes the patching procedure to assign instruments and/or microphones connected to [MIC/LINE INPUT] jacks 1–8 to independent tracks for direct recording.



• See page 99 for more details on patching for direct recording.

- 1 Lower the [STEREO] fader to the  $-\infty$  position.
- 2 Referring to “Connection and Setup” on page 37, connect your instruments and/or microphones and set up the input levels.
- 3 Call the RECORD screen Direct page by either pressing the Quick Navigate section [RECORD] key as many times as necessary, or by pressing the [F1] key after pressing the [RECORD] key.

Input channel signals can be directly patched to the recorder’s tracks via the RECORD screen Direct page. When this page is called the [INPUT SEL] keys in the upper area of the top panel will flash red.

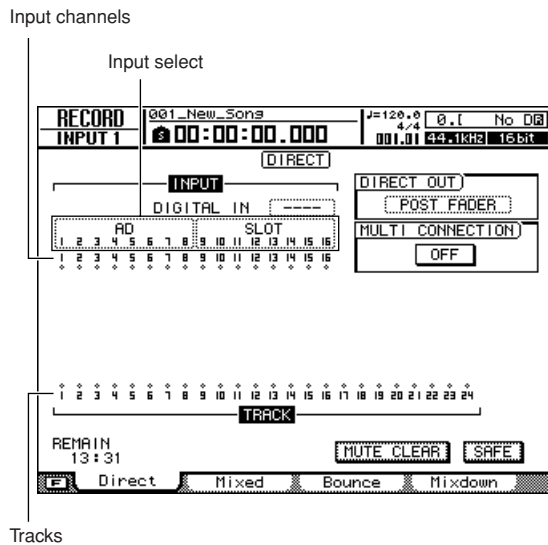

### 4 Check that “AD1–8” appears in the input select field on the left side of the page.

Input channels 1–8 or 9–16 can be selected as the input source via the input select field. When “AD1–8” is showing the AW2400’s AD inputs ([MIC/LINE INPUT] jacks 1–8) are selected as the input source. If a different input source is selected move the cursor to the input select field and use the [DATA/JOG] dial or [INC]/[DEC] keys to select “AD1–8”.

### 5 Press the [INPUT SEL] key for the input channel to which your instrument/microphone is connected.

The corresponding [INPUT SEL] key will light red, and the remaining [INPUT SEL] keys will go dark. If, for example, you have selected input channel 1 as your record source the top panel keys will appear as follows.

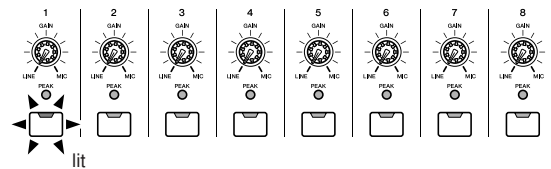

The display will appear as shown here.



• You can also select an input channel by moving the cursor to the  $\diamond$  symbol of the desired input channel and pressing the [ENTER] key.

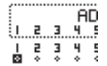

• To select the [DIGITAL STEREO IN] connector as the record source you will need to assign the [DIGITAL STEREO IN] connector to an adjacent pair of odd- and even-numbered tracks via the DIGITAL IN field (1.2–15.16). See page 100 for details.



### 6 Press the Layer section [TRACK 1-12] key so that its indicator lights.

This selects the TRACK 1-12 mixing layer so you can use [ON] keys 1–12, [SEL] keys 1–12, and faders 1–12 to operate track channels 1–12. At this point faders 1–12 will move to the current level settings for track channels 1–12.

### 7 Press the [SEL] key of the track channel on which you want to record.

The selected input channel and track will be connected internally. At this time, only the selected [INPUT SEL] key and [SEL] key will be flashing red. The flashing [SEL] key indicates that the corresponding track is in record-ready mode.

If, for example, you have patched input channel 1 to track 1 the top panel keys will appear as follows.

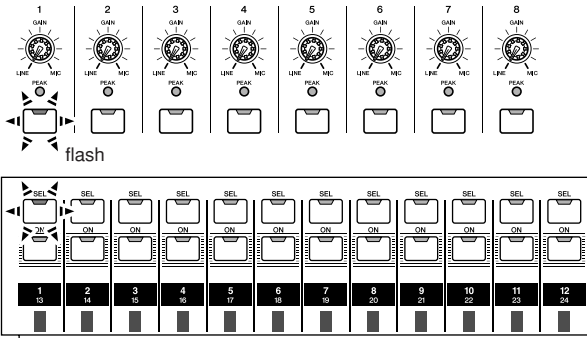

Track channels  
(Layer section [TRACK 1-12] key lit)

The display will appear as shown here.



- Input channels that are patched to tracks will be automatically disconnected from the stereo bus and their signal will not be output via the [STEREO OUT] or [MONITOR OUT] jacks (the signals being recorded can be monitored via the track channel being recorded).
- When an input is disconnected from a track, that input is automatically re-patched to the stereo bus.
- You can also select a track by moving the cursor to the ◊ symbol of the desired track and pressing the [ENTER] key.



- The track numbers of muted tracks will be displayed as **M** (mute), but you can still record to muted tracks.
- Since 24-bit songs can have a maximum of 12 play tracks (→ p. 165), tracks 13–24 are muted and will not play back.

**8** If you want to record more than one instrument or microphone simultaneously, assign other input channels to tracks in the same way.



- To cancel a patched connection press the [INPUT SEL] key so that it lights red, then press the [SEL] key of the track that is selected as the record destination. To cancel all connections, move the cursor to the SAFE button and press the [ENTER] key.

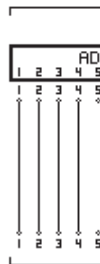

**9** Raise the [STEREO] fader to the 0 dB position.

At this point the track channel faders are set to  $-\infty$ , so no sound will be heard from the monitor system.

**10** Check that the Layer section [TRACK 1-12] key is lit, then raise the fader of the track selected as the record destination to an appropriate monitor level.

Normally when recording you don't monitor the input channel signal before it is recorded, but rather via the track channel after it has passed through the recorder. This lets you monitor the signal that is actually being recorded as well as adjust the volume and tone of the monitor signal without affecting the signal that is being recorded.

● **To Adjust Volume/Balance**

Set the fader of the corresponding track channel as required.

● **To Adjust Pan**

After pressing the [SEL] key of the corresponding channel press the Selected Channel section [PAN/EQ] key so that its indicator lights. Selected Channel knob 1 can now be used to adjust panning for the channel currently selected via the [SEL] keys. For more details refer to "Pan Control" on page 147.



- In the direct-record mode adjusting the pan of the record source input channel has no effect.

**11** To check the level of a signal being applied to a record-ready track press the [METER] key and then the [F2] key.

This calls the METER screen Track page. In this page you can monitor the levels of the signals at the inputs of track channels 1–24, sent from the input channels to the recorder tracks.

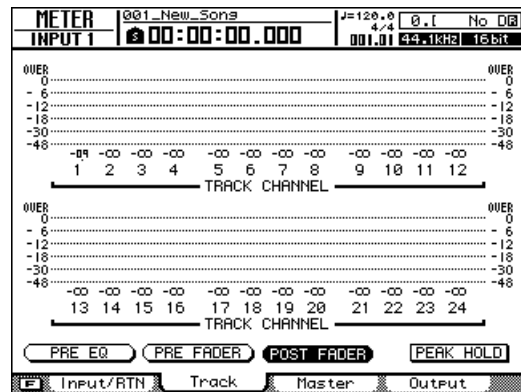

**12** Move the cursor to the PRE EQ button and press the [ENTER] key.

The input levels of the track channels corresponding to the record-ready tracks will be displayed. If any of the signals reach the "OVER" level the input level setting will need to be reduced. Refer to "Connection and Setup" on page 37 and readjust the input levels.

● Monitor signal flow during recording

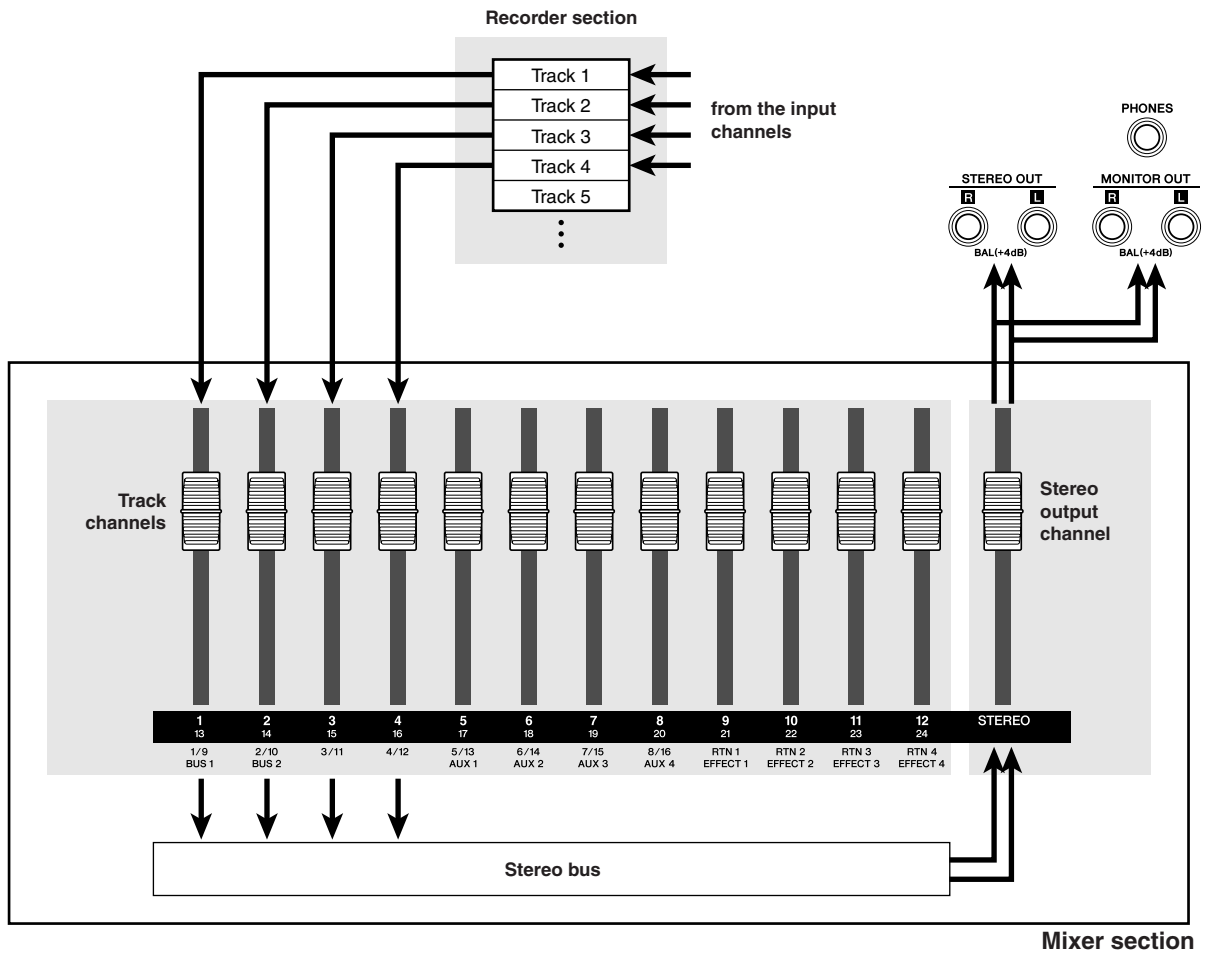

This completes the patch setup for direct recording.

**NOTE**

- If you switch the RECORD display page after doing the patch setup all your patch settings will be undone and lost (a confirmation popup window will appear). Remember to stay on the same RECORD page until recording is finished.

## Assigning input signals to tracks (Mixed recording)

Use the following procedure to set up the patching so you can mix and record the signals from multiple instruments/mics connected to [MIC/LINE INPUT] jacks 1–8 to one or more tracks.



• Refer to page 102 for more details on patching for mixed recording.

6

Track recording

- 1 Lower the [STEREO] fader to the  $-\infty$  position.
- 2 Referring to “Connection and Setup” on page 37, connect your instruments and/or microphones and set up the input levels.
- 3 Call the RECORD screen Mixed page by either pressing the Quick Navigate section [RECORD] key as many times as necessary, or by pressing the [F2] key after pressing the [RECORD] key.

Via the RECORD screen Mixed page you can patch multiple input channels to either of the AW2400’s stereo buses (Bus1 and Bus2), allowing mixed signals to be assigned to up to four tracks.

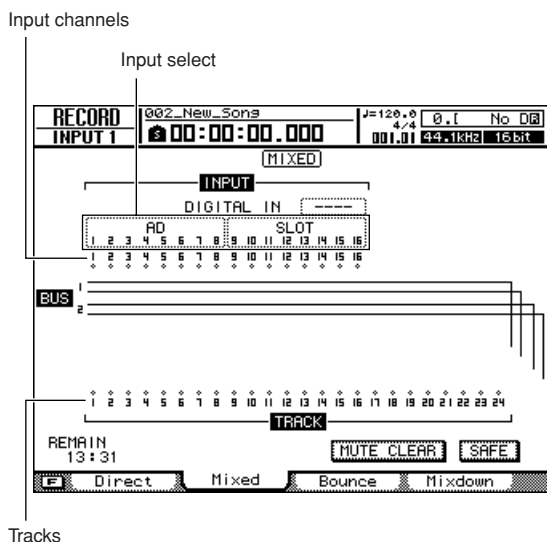

- 4 Check that “AD1–8” appears in the input select field on the left side of the page. If a different input source is selected move the cursor to the input select field and use the [DATA/JOG] dial or [INC]/[DEC] keys to select “AD1–8”.

- 5 Press the [INPUT SEL] key for the input channel to which your instrument/microphone is connected.

The currently selected [INPUT SEL] key will light orange, and that input channel will be selected for operation.

The  $\diamond$  symbol for the corresponding input channel will be highlighted in the screen, and a line will appear indicating that this channel is connected to the bus.

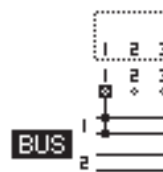

- 6 Repeatedly press the same [INPUT SEL] key to select the bus to which you want to send the signal from that input channel.

Each time you press the [INPUT SEL] key the screen will change as follows.

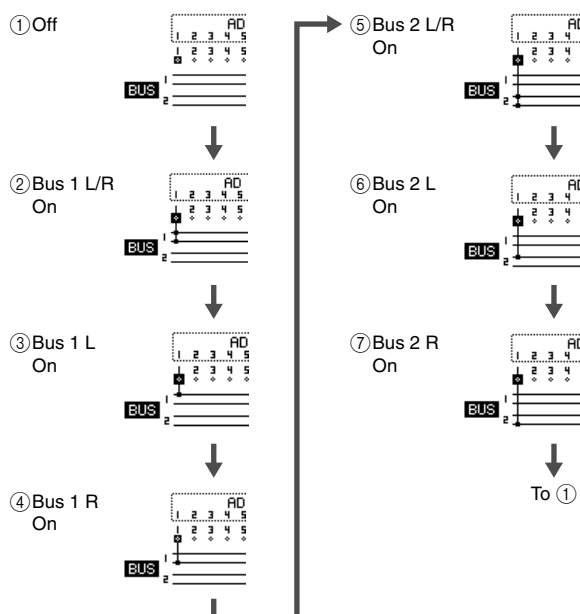

- Input channels that are patched to Bus1 or Bus2 will be automatically disconnected from the stereo bus and their signal will not be output via the [STEREO OUT] or [MONITOR OUT] jacks (the signals being recorded can be monitored via the track channel being recorded).
- When an input is disconnected from Bus1 or Bus2, that input is automatically re-patched to the stereo bus.
- You can also switch to Bus1/Bus2 by moving the cursor to the  $\diamond$  symbol of the desired input channel and pressing the [ENTER] key.

- 7 Use the same procedure to specify other input channels as recording sources as required.



- To select the [DIGITAL STEREO IN] connector as the record source you will need to assign the [DIGITAL STEREO IN] connector to an adjacent pair of odd- and even-numbered tracks via the DIGITAL IN field (1.2–15.16). See page 102 for details.

## 8 Press the Layer section [TRACK 1-12] key so that its indicator lights.

This selects the TRACK 1-12 mixing layer so you can use [ON] keys 1-12, [SEL] keys 1-12, and faders 1-12 to operate track channels 1-12. At this point check that all faders are set to their minimum  $-\infty$  positions.

## 9 Press the [SEL] key(s) for the record-destination track(s).

You can select up to four tracks for recording. Bus1 L and Bus2 L can be assigned to odd-numbered tracks, while Bus1 R and Bus2 R can be assigned to even-numbered tracks. The [SEL] keys of track channels to which buses have been assigned will flash red and the record-ready mode will be engaged.

For example, the display will change as shown when the track channel 1 [SEL] key is pressed repeatedly.

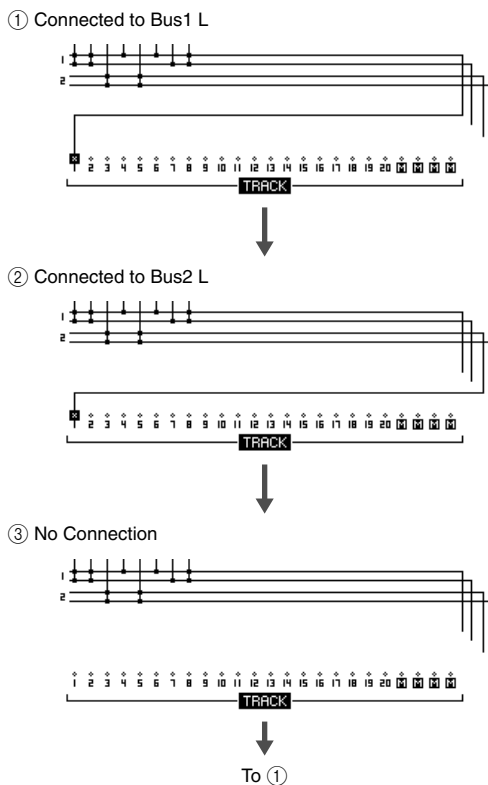

### HINT

- This operation can also be carried out by moving the cursor to the  $\diamond$  mark of the record track and repeatedly pressing the [ENTER] key.
- When paired tracks ( $\rightarrow$  p. 58) are selected as the record destination the pan settings of the odd- and even-numbered tracks will automatically be set to left and right, respectively, allowing the pair to be used as a stereo track.
- When a single track is selected as the record destination the pan of the corresponding track channel will automatically be set to center.
- To cancel all connections, move the cursor to the SAFE button and press the [ENTER] key.

### NOTE

- The track numbers of muted tracks will be displayed as  $\blacksquare$  (mute), but you can still record to muted tracks.
- Since 24-bit songs can have a maximum of 12 play tracks ( $\rightarrow$  p. 165), tracks 13-24 are muted and will not play back.

## 10 Raise the [STEREO] fader to the 0 dB position.

## 11 Check that the Layer section [TRACK 1-12] key is lit, then raise the fader of the track selected as the record destination to an appropriate monitor level.

The signal sent to the track via Bus1/Bus2 will be output via the [STEREO OUT] and [MONITOR OUT] jacks.

## 12 To set the level and pan for input channels 1-8 press the Layer section [IN 1-8] key so that its indicator lights.

If multiple input channels are patched to the same bus the individual level and pan settings for each input cannot be changed after recording. For this reason it is necessary to set up the individual channel levels and pan applied to Bus1/Bus2 as required before recording.

### ● To Adjust Volume/Balance

Set the input channel 1-8 faders as required.

### ● To Adjust Pan

After pressing the [SEL] key of the corresponding input channel press the Selected Channel section [PAN/EQ] key so that its indicator lights. Selected Channel knob 1 can now be used to adjust panning for the channel currently selected via the [SEL] keys. For more details refer to "Pan Control" on page 147.

### NOTE

- When the outputs from multiple channels are mixed and recorded it may be necessary to adjust the input channel faders to prevent the combined signal level from getting too high.
- We recommend that you not use the [GAIN] knob to adjust the volume balance of the input channels. This will degrade the S/N ratio, and may cause the sound to distort.
- To hear the input channel pan settings via the monitor system the track channels corresponding to the two record-destination tracks should be assigned as a pair.

**13 To monitor the signal levels sent from Bus1/Bus2 to the record-ready tracks press the [METER] key and then the [F3] key.**

This calls the METER screen Master page, allowing visual monitoring of the output levels from Bus1 and Bus2.

Bus1 and Bus2 output level.

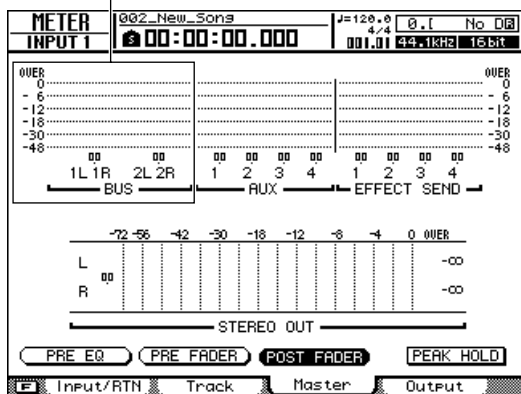

**14 Move the cursor to the POST FADER button and press the [ENTER] key.**

The post-fader signal levels will be displayed.

If the signal levels reach “OVER” on the meters press the Layer section [MASTER] key so that it lights to select the MASTER mixing layer, and use fader 1 (Bus1) and fader 2 (Bus2) to adjust the master levels for Bus1 and Bus2 as required.

**NOTE**

• If you switch the RECORD display page after doing the patch setup all your patch settings will be undone and lost (a confirmation popup window will appear). Remember to stay on the same RECORD page until recording is finished.

## Recording on a track

Now that the necessary preparations have been completed, let's record on a track.

**1 Call the TRACK screen View page by either pressing the Work Navigate section [TRACK] key as many times as necessary, or by pressing the [F1] key after pressing the [TRACK] key.**

This page can be used to confirm which tracks do and do not contain recorded data. You can also make any required metronome settings via this page (refer to page 62 for metronome instructions).

Track view

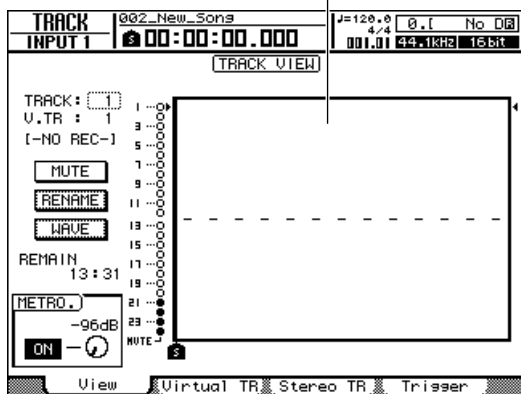

**2 Press the Transport section RTZ [⏪] key to return to the beginning of the song.**

**3 Hold down the Transport section REC [●] key and press the PLAY [▶] key to start recording.**

Recording will begin on the track set up as the record destination. In the track view within the screen, the vertical line that indicates the current location will advance towards the right.

**NOTE**

• Recording will not begin if no track is in the record-ready mode.

**4 To stop recording, press the STOP [■] key.**

The recorded audio data will appear in bar-graph form in the track view.

The data entry/control section [UNDO/REDO] key will light. This indicates that you can press the [UNDO/REDO] key to execute the Undo function.

**5 To hear the recording from the beginning, press the RTZ [⏪] key to return the counter display to zero and press the PLAY [▶] key.**



## 6 If you want to redo the recording, press the [UNDO/REDO] key.

The [UNDO/REDO] key will go out, and you will return to the state prior to recording. Repeat steps 2–5.

## 7 If you are satisfied with the recorded content, save the song. (For details on saving, refer to “Saving the current song”.)

Please be aware that the recorded content will be lost if you turn off the AW2400 power before saving the song.

## 8 When you finish recording, press the Quick Navigate Section [RECORD] key once again, move the cursor to the SAFE button, and press the [ENTER] key.

When the confirmation popup window appears so move the cursor to the OK button and press the [ENTER] key. The input-to-track assignments will be cancelled. The REC [●] key will be disabled to prevent accidental recording.

# Saving the current song

This section explains how to save the current song to the hard disk. If you accidentally turn off the AW2400 power without saving the song, all recordings or operations that you performed since last saving the song will be lost. You should make a habit of saving the song at appropriate breaks in your work.

## 1 Call the SONG screen Song List page by either pressing the Work Navigate section [SONG] key as many times as necessary, or by pressing the [F1] key after pressing the [SONG] key.

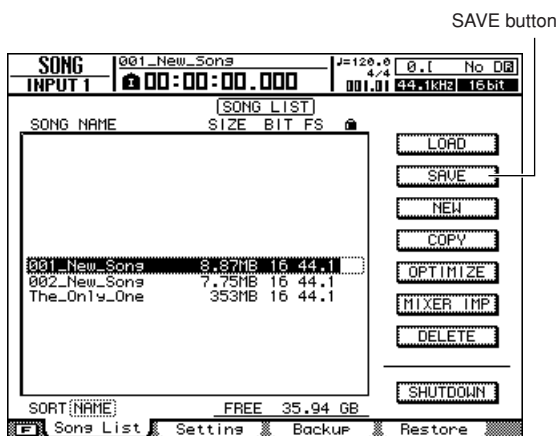

## 2 Move the cursor to the SAVE button and press the [ENTER] key.

A popup window will ask you to confirm that you want to save the current song.



## 3 To save the song, move the cursor to the YES button and press the [ENTER] key.

If you move the cursor to the NO button (instead of the YES button) and press the [ENTER] key, the Save operation will be cancelled.

### NOTE

- The song save operation always saves the current song, regardless of the song that is selected in the list.
- You cannot save a song that is protected. If, for example, you have edited the mixer settings and need to save the song, you must disable the protect setting and then save the song. (For details on song protection, refer to page 172)

### HINT

- A number of other operations are available in the SONG screen List page. Refer to “Managing Your Songs” on page 167 for details.
- In the following situations a popup window will ask whether you want to save the current song: when you load an existing song from the hard disk, when you create a new song, or when you shut-down the AW2400.
- We recommend that you frequently save the song you are working on or enable the Auto Save function (→ p. 211) as a safeguard against accidents such as the AW2400’s power cable being accidentally disconnected.

# Pairing channels

Adjacent odd- and even-numbered input channels (1/2–15/16), track channels (1/2–23/24), and AUX send master channels (1/2 and 3/4) can be set as pairs. When channels are paired most of their parameters are linked for optimum efficiency and easy when handling stereo signals. Channels can be set as pairs either via the MONITOR screen or by using the panel [INPUT SEL] or [SEL] keys.

**NOTE**

- When channels are paired always operate only the fader of one channel. Attempting to operate both faders at once can result in damage to the faders' motor drive system.

6

Track recording

## Pairing Channels via the MONITOR Screen

1 Call the MONITOR screen Pair page by either pressing the Quick Navigate section [MONITOR] key as many times as necessary, or by pressing the [F1] key after pressing the [MONITOR] key.

This page contains the following items.

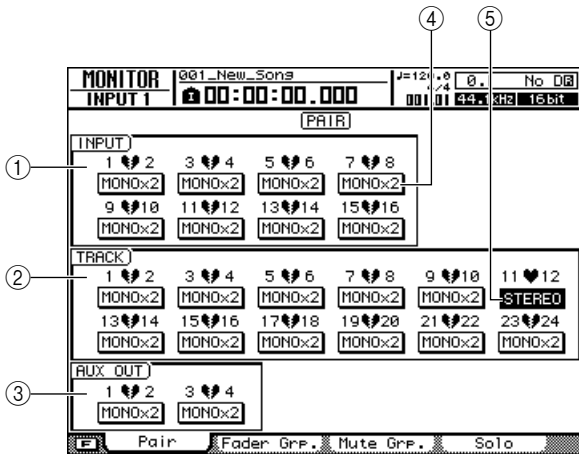

- ① **INPUT field**  
Pairs or disengages pairing for input channels 1–16.
- ② **TRACK field**  
Pairs or disengages pairing for track channels 1–24.
- ③ **AUX OUT field**  
Pairs or disengages pairing for AUX send channels 1–4.
- ④ **MONOx2 buttons**  
Indicate that the adjacent channels are functioning as independent mono channels.
- ⑤ **STEREO buttons**  
Indicate that the two channels are functioning as a stereo pair.

2 Move the cursor to the MONOx2 button of a channel you want to assign as a stereo pair and press the [ENTER] key.

A pairing confirmation popup window will appear.

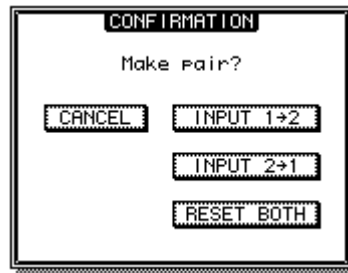

The popup window contains the following items.

- **INPUT (TRACK, AUX OUT) x → y**  
(x= odd number, y= even number)  
..... Copy the settings of channel x to y, and pair them.
- **INPUT (TRACK, AUX OUT) y → x**  
(x= odd number, y= even number)  
..... Copy the settings of channel y to x, and pair them.
- **RESET BOTH** ..... Initialize both channels, and pair them.
- **CANCEL** ..... Cancel pairing.

3 Move the cursor to the appropriate button in the popup window and press the [ENTER] key.

The MONOx2 button will change to a STEREO button. The following parameters are linked for paired channels.

- **Input Channels**  
All mix parameters other than the [GAIN] knob and phase/pan settings.
- **Track Channels**  
All mix parameters other than the phase/pan settings.
- **AUX Send Master Channels**  
All mix parameters.

- To disengage a pair, move the cursor to the corresponding STEREO button and press the [ENTER] key.

A popup window will ask you to confirm that you want to disengage the pair.



- Move the cursor to the OK button and press the [ENTER] key to confirm and disengage the pair.

The STEREO button will change to a MONOx2 button. If you move the cursor to the CANCEL button and press the [ENTER] key the disengage-pair operation will be aborted and the channels will remain paired.

**HINT**

- All channel pairs can be disengaged at once by pressing the [F1] key while holding the Display section [SHIFT] key.
- For paired channels set the pan control to either full left or right to achieve nominal level (i.e. the same level before and after the pan control). For channels that are not paired nominal level is achieved with the pan control set to center.

## Channel Pairing Using the Panel Keys

- Use the Layer section keys to select the mix layer containing the channels you want to pair.
- While holding the [SEL] key of one channel that you want to pair, press the [SEL] key of the adjacent channel.

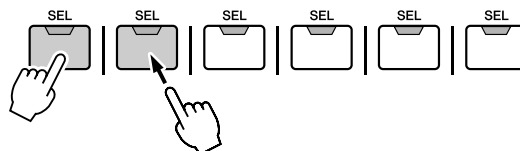

A popup window will appear, asking you to confirm the pairing.

The popup window contains the same items as the MONITOR screen used for channel pairing.

**HINT**

- The [INPUT SEL] 1-8 keys can also be used to pair input channels 1-8.

- Move the cursor to the appropriate button in the popup window and press the [ENTER] key.

The channels specified via the [SEL] keys will be paired.

- To disengage pairing, press the [SEL] key of one of the paired channels while holding the [SEL] key of the other channel.

A popup window will ask you to confirm that you want to disengage the pair.

- To disengage the pair, press the OK button. If you decide not to disengage the pair, move the cursor to the CANCEL button and press the [ENTER] key.

## Applying EQ To an Input Signal

The AW2400 provides versatile 4-band equalizers on every channel that can be directly operated via the Selected Channel section keys and knobs.

This section describes the procedure for applying EQ to input channels 1–8.

- 1 Press the Layer section [IN 1-8] key so that its indicator lights, then press the [SEL] key for the channel to which EQ is to be applied.



- The [INPUT SEL] 1–8 keys can also be used to select an input channel for equalization.

- 2 Press the Selected Channel section [PAN/EQ] key so that its indicator lights. Press Selected Channel knob 1, 2, 3, or 4 and the PAN/EQ screen will appear.

- 3 Press the Display section [F3] key to call the EQ/Att. page.

The EQ settings are available via this page.

EQ ON/OFF button

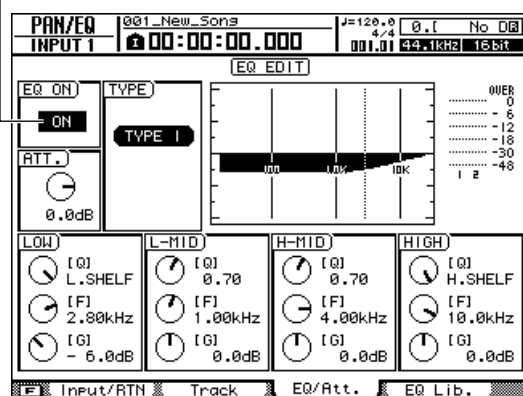

- Pages can also be selected by repeatedly pressing Selected Channel section knobs 1–4.

- 4 To turn the EQ on, move the cursor to the EQ ON/OFF button and press the [ENTER] key.

- 5 Press the Selected Channel section [LOW], [LO-MID], [HI-MID] or [HIGH] key to select the EQ band to be adjusted.

- 6 Use Selected Channel section knobs 2–4 to adjust the EQ as required.

When the [PAN/EQ] key is lit, Selected Channel knobs 2–4 perform the following functions: knob 2 adjusts the Q, knob 3 adjusts the center frequency, and knob 4 adjusts the gain of the selected band.

- 7 Repeat steps 5 and 6 to set all bands as required.



- In addition to the ability for fine EQ control as described above, the supplied EQ library contains preset EQ setups for a variety of instruments that can be recalled and used or edited as required. Refer to “Pan, EQ, and Dynamics Processing” on page 147 for details.

# Applying Compression to an Input Signal

The AW2400 provides dynamics processing capability on all input and track channels: compression on the track channels, and both compression and gating on the input channels. The dynamics processor parameters are adjusted manually via the Selected Channel section in the same way as the EQ parameters. A range of dynamics presets for a variety of instruments is also provided in the dynamics library.

In this section we'll see how to recall dynamics processor preset from the library and apply compression to the channel 1–8 signals.

- 1 Press the Layer section [IN 1-8] key so that its indicator lights, the press the [SEL] key for the channel to which compression is to be applied.



• The [INPUT SEL] 1–8 keys can also be used to select an input channel for compression.

- 2 Press the Selected Channel section [DYN] key so that its indicator lights.

The DYNAMICS screen will appear.



• If the AUTO DISPLAY function is set to OFF, the DYNAMICS screen will not appear automatically when the [DYN] key is pressed. In this case press one of the Selected Channel knobs (1–4) after pressing the [DYN] key so that its indicator lights. For details about the AUTO DISPLAY function refer to "AW2400 Preferences" on page 210.

- 3 Press the Display section [F3] key, or press the [DYN] key as many times as necessary until the Comp Edit page appears.

The compressor settings are available via this page.

COMP ON/OFF button

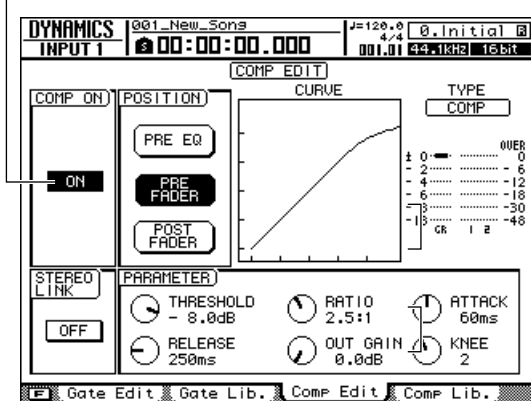

• Pages can also be switched by repeatedly pressing a Selected Channel knob.

- 4 Move the cursor to the COMP ON/OFF button and press the [ENTER] key to turn the compressor on.

This activates the compressor for the corresponding input channel.



• If necessary the individual compressor parameters can be adjusted via this page. Refer to "Using the Compressors" on page 152 for details.

- 5 Press the Display section [F4] key.

The DYNAMICS screen Comp Lib. page will appear. Compressor library presets can be recalled via this page. The currently selected compressor type and its graphic response curve are shown at the top of the display.

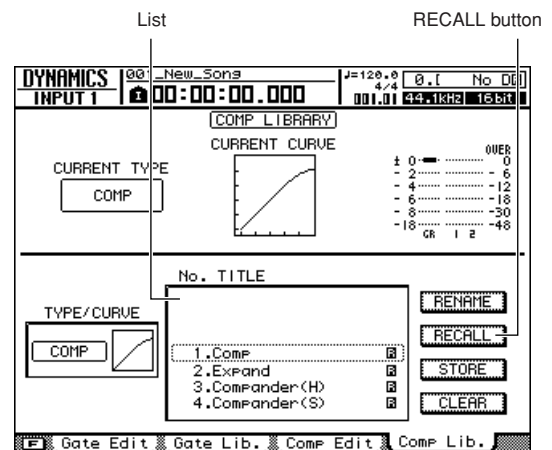

- 6 Use the [DATA/JOG] dial or [INC]/[DEC] keys to select the library setting to be recalled.

The setting highlighted by a dotted frame is currently selected for recall.

Each setting has a name that indicates the instrument or application it is intended to be used for. The compressor types and response curves are displayed to the left of the list.

**7** Move the cursor to the **RECALL** button and press the **[ENTER]** key.

A popup window confirming the recall operation will appear.

**8** To actually recall the selected setting move the cursor to the **OK** button and press the **[ENTER]** key.

The selected setting will be recalled and the compressor type and parameters will change accordingly. Repeat steps 6–8 as necessary to select various presets until you find one that best suits your application.

**9** Use **Selected Channel knob 1** to change the overall effect of the compressor.

When the knob is operated the **DYNAMICS** screen **Comp Edit** page will appear. If **Selected Channel knob 1** is operated while the **[DYN]** key is engaged, multiple compressor parameters are adjusted simultaneously to change the overall effect of the compressor (the actual change will depend on the preset selected from the library).

**NOTE**

• If a **Selected Channel knob** is operated while the **AUTO DISPLAY** function is **OFF**, rather than the display switching to the **Comp Edit** page a popup window containing the relevant parameters will appear. For details about the **AUTO DISPLAY** function refer to “**AW2400 Preferences**” on page 210.

## Handy Recording Functions

This section describes a number of functions that are handy for recording.

### Using the Metronome

Activating the metronome and setting the tempo and volume.

**1** Call the **TRACK** screen **View** page by either pressing the **Work Navigate** section **[TRACK]** key as many times as necessary, or by pressing the **[F1]** key after pressing the **[TRACK]** key.

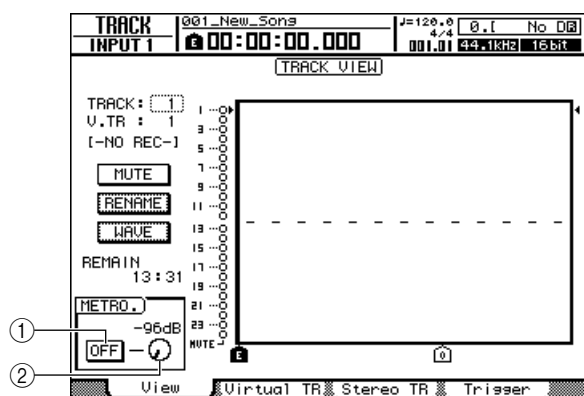

**1 Metronome button**

Switches the metronome on/off.

**2 Metronome knob**

Adjusts the metronome volume level. The current value is shown above the knob in dB units.

**2** Move the cursor to the **metronome** button and press the **[ENTER]** key.

The metronome will be turned on. In this state the metronome will sound during recording and playback.

**3** The metronome will begin sounding when the **PLAY [▶]** key is pressed to begin playback.

Move the cursor to the metronome knob and use the **[DATA/JOG]** dial or **[INC]/[DEC]** keys to adjust the metronome level as required.

**4** To change the tempo or time signature, first press the **STOP [■]** key to stop the recorder. Call the **EDIT** screen **Tempo Map** page by either pressing the **Work Navigate** section **[EDIT]** key as many times as necessary, or by pressing the **[F2]** key after pressing the **[EDIT]** key.

The **Tempo Map** page lets you create a tempo map that specifies the tempo and time signature of the song. The tempo and time signature that you specify here will be the basis for the measure/beat display counter, the internal metronome, and the **MTC** (**MIDI Time Code**) transmitted and received by the **AW2400**.

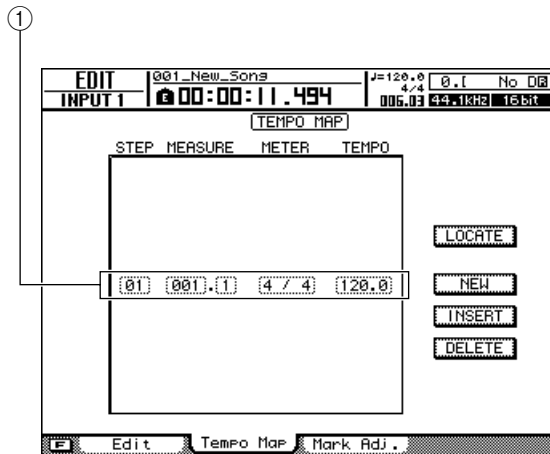

### ① Tempo map events

These are the events recorded in the tempo map. When you create a new song, a tempo map event of time signature = 4/4 and tempo = 120 will be created at the beginning of the song (measure 1, beat 1).

### 5 Move the cursor to the TEMPO field of the event, and use the [DATA/JOG] dial or [INC]/[DEC] keys to set the tempo value.

The tempo can be set from 30 to 250 (BPM).

### 6 If necessary, move the cursor to the METER field and use the [DATA/JOG] dial or [INC]/[DEC] keys to change the time signature.

The time signature can be set from 1/4 to 8/4.

#### HINT

- It is also possible to change the tempo or time signature during a song. For details, refer to "Creating a tempo map" (→ p. 175).

## Switching virtual tracks

Each audio track contains eight virtual tracks. After overdubbing a solo part, you can switch the virtual track for that track, and record a different take while preserving the previously-recorded content.

### 1 Call the TRACK screen Virtual TR page by either pressing the Work Navigate section [TRACK] key as many times as necessary, or by pressing the [F2] key after pressing the [TRACK] key.

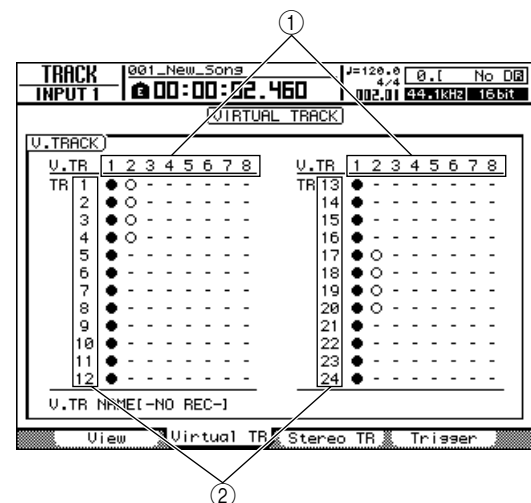

### ① Virtual tracks

Indicates the status of virtual tracks 1–8. The virtual track that is currently selected for each track is indicated by a "●" symbol. Of the virtual tracks that are currently not selected, those that have been recorded are indicated by "○", and those that have not yet been recorded are indicated as "-".

### ② Tracks

### 2 Use the cursor keys to select the virtual track number that you want to assign to the desired track.

### 3 Press the [ENTER] key.

The "●" symbol will be displayed at the position of the newly-selected virtual track. This virtual track will now be used for recording/playback.

## Using the Undo List

By using the AW2400's Undo list, you can not only cancel the most recent recording or editing operation, but even backtrack through your work for as many as fifteen operations.

This is convenient when, for example, after performing several overdubs you decide that you would rather go back to the state immediately after you had recorded the third solo.

### 1 Press and hold the [UNDO/REDO] key.

The UNDO LIST popup window will appear.

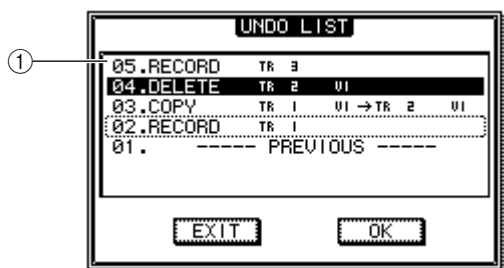

#### 1 Undo list

This is a list of the previous recording and editing operations. From the left, the list shows a step number that indicates the order in which the operations were performed, the content of the operation, and the track/virtual track that was affected by the recording or editing operation.

The current song is now in the state of the step that is highlighted.

The step enclosed by a dotted frame indicates the step to which the song will be returned by the Undo function.

#### NOTE

- If you have already cancelled recent operations using the Undo function before displaying the Undo list, previous steps may not remain at all.

### 2 Use the [DATA/JOG] dial or [INC]/[DEC] keys to select a step number.

### 3 Move the cursor to the OK button and press the [ENTER] key.

The current song will revert to the state of the step you selected.

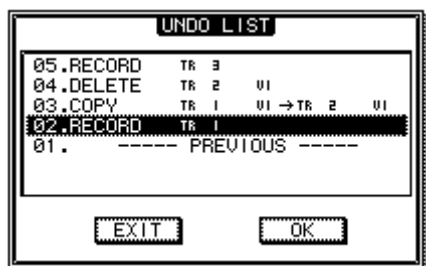

### 4 Move the cursor to the EXIT button and press the [ENTER] key.

The popup window will close, and you will return to the previous screen.

#### HINT

- Please note that if you record or edit after "undoing" back to a certain step, the undo/redo data subsequent to that step will be erased. For example if you "undo" the previous three steps, and then perform a recording or editing operation, the undo/redo data for the previous steps 1 and 2 will be erased.
- If you press the [UNDO/REDO] key while it is lit the previous operation will be undone without opening the Undo List (the key indicator will go out when the UNDO operation is performed). Press the [UNDO/REDO] key a second time to "redo" the undone operation.



# ◆ Chapter 7 ◆

## Overdubbing

This chapter explains how you can record additional performances on other tracks while you listen to the previously-recorded tracks.

### About overdubbing

“Overdubbing” is the process of recording additional performances on other tracks while you monitor the playback of previously-recorded tracks.

The diagram below shows the signal flow when you play back tracks 1–4 and overdub track 5. In this example, the signal that is input from [MIC/LINE INPUT] jack 1 is routed through recorder track 5 and sent to track channel 5. This signal is then sent to the stereo bus, mixed with the playback sound of track channels 1–4, and output from the [STEREO OUT] jacks and the [MONITOR OUT] jacks / [PHONES] jack.

#### ● Signal flow when overdubbing

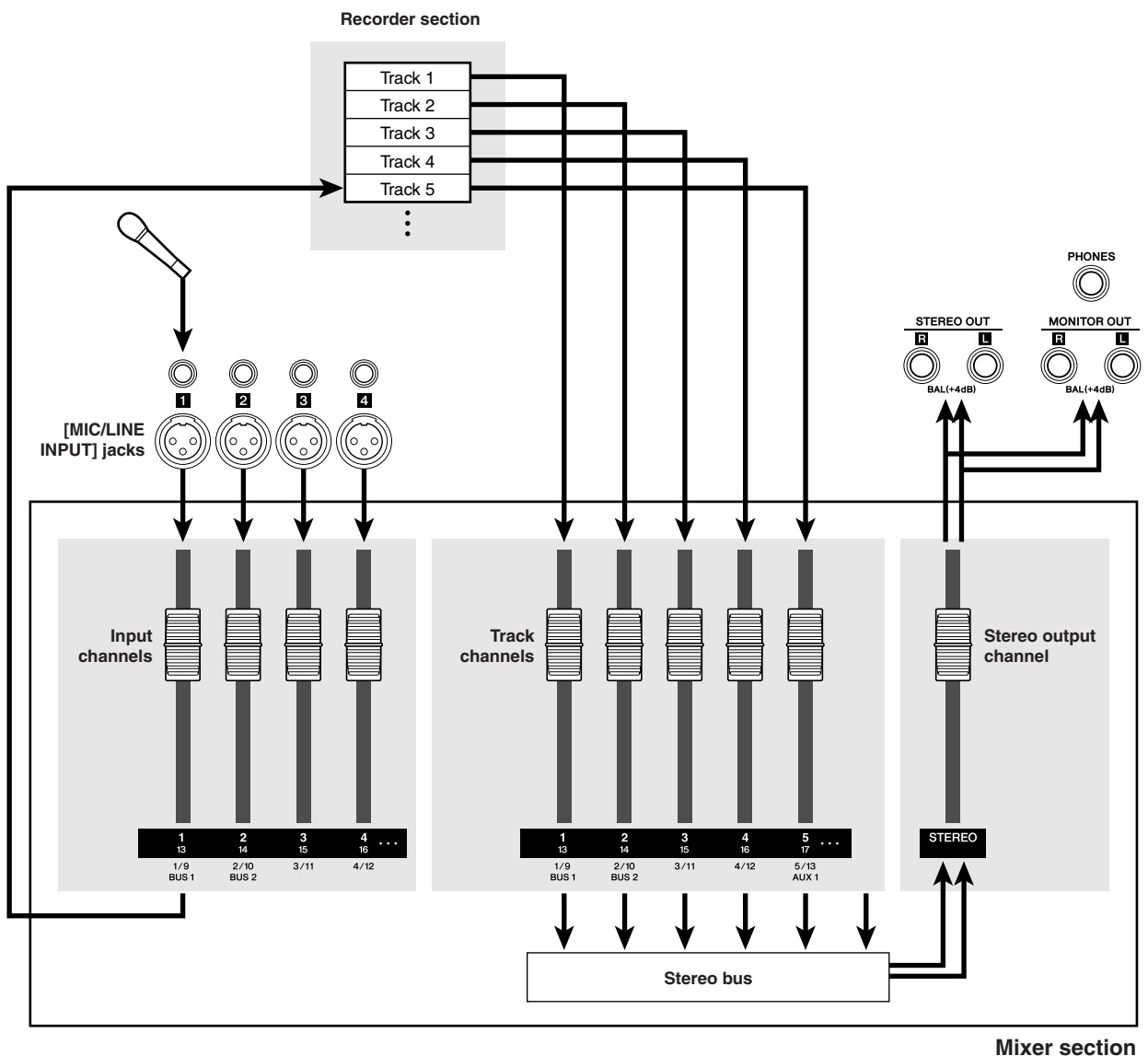

## Assigning the input signal to a track

In order to overdub, you must first assign the mic or instrument to a new track. The basic procedure is the same as when recording the first track.

- 1 Lower the [STEREO] fader to the  $-\infty$  position.
- 2 Connect your instrument or mic to a [MIC/LINE INPUT] jack.
- 3 Call the RECORD screen Direct page by either pressing the Work Navigate section [RECORD] key as many times as necessary, or by pressing the [F1] key after pressing the [RECORD] key.
- 4 Assign the input channel to which your instrument/mic is connected to a new track, and adjust the level.

For details on this step, refer to “Assigning input signals to tracks (Direct recording)” (→ p. 51).

The diagram below shows an example of when input channel 1 is assigned to track 5.

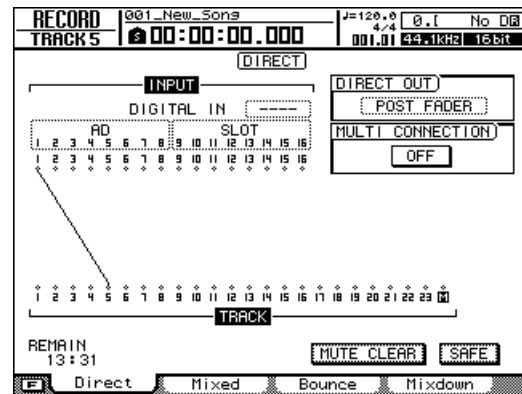

### HINT

- In this example we will use “direct recording,” in which one input channel is assigned to one track. However, you may also use “mixed recording,” in which multiple input channels are sent to the Bus 1/2 and recorded on one through four tracks.

## Setting the mix balance and pan

Here's how to set the volume balance and pan for the previously-recorded tracks and the tracks that you now will be overdubbing.

- 1 While you play back the song, raise the track channel faders for the previously-recorded tracks to an appropriate monitoring level.**



- For example if you've already recorded tracks 1–4, press the Layer section [TRACK 1-12] key to make it light, and use the top panel faders 1–4 to control track channels 1–4.

- 2 Press the [SEL] key for a previously-recorded track, and press the Selected Channel section [PAN/EQ] key so that its indicator lights.**

- 3 Rotate the Selected Channel knob 1 to adjust the pan.**

Adjust the pan in the same way for the other track channels.

- 4 Stop the recorder, and while producing sound on your instrument, adjust the fader of the recording-destination track channel so that the monitoring level is appropriate.**

The track channel for the recording-destination track will send the input signal to the stereo bus while recording or stopped, and will send the track playback signal to the stereo bus during playback. This means that in order to monitor the input signal, you must stop the recorder.



- The position of the track channel faders will not affect the recording level. However if you set the faders to 0 dB, the playback volume will be the same as when you recorded the tracks.

- 5 Press the [SEL] key for the recording-destination track channel, and press the Selected Channel section [PAN/EQ] key so that its indicator lights.**

- 6 Rotate the Selected Channel knob 1 to adjust the pan.**

In the same way as for the input channel signal, you can also use EQ and dynamics (compressor) to process the track channel.

By operating the track channel you've selected as the recording-destination, you can adjust the panning or tone of the monitor signal without affecting the signal that is actually recorded.



- For details on how to adjust the pan, EQ, and dynamics processing, refer to "Pan, EQ, and Dynamics Processing" (→ p. 147).

## Overdubbing

Now you can overdub onto the track that you selected as the recording-destination.

- 1 Call the TRACK screen View page by either pressing the Work Navigate section [TRACK] key as many times as necessary, or by pressing the [F1] key after pressing the [TRACK] key.

This page displays all tracks side by side, making it easy to see the relationship between tracks and the current location within the song.

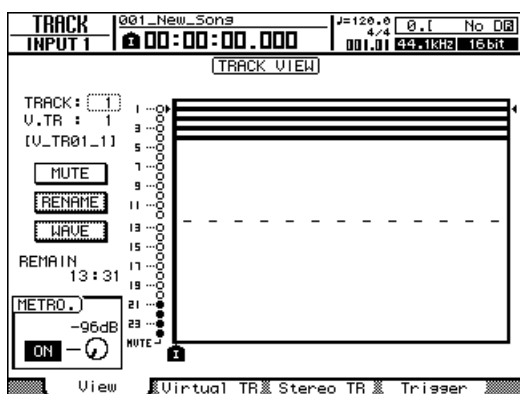

- 2 In the transport section, hold down the REC [●] key and press the PLAY [▶] key. Recording will begin.

- 3 While monitoring the previously-recorded tracks, play the instrument that you want to overdub.
- 4 To stop recording, press the STOP [■] key. The [UNDO/REDO] key in the data entry / control section will light.
- 5 To listen to the recorded performance from the beginning, press the RTZ [◀] key to return the counter display to zero, and press the PLAY [▶] key.



• If you recorded from the middle of the song, you can press the [IN] key to move to the location at which you began recording.

- 6 If you are satisfied with the recorded performance, save the song. (For details on saving → p. 57)

If you decide to re-do the recording, press the [UNDO/REDO] key to cancel the recording, and repeat steps 2–6.

## Punch-in/out

If you make a mistake while overdubbing, you can re-record just the region in which you made the mistake. This process is called “punch-in/out.”

Punch-in/out can be performed either as “manual punch-in/out” in which you switch between recording and playback manually, or as “auto punch-in/out” in which recording and playback will switch automatically when you reach the locations you specify beforehand.

### Manual punch-in/out

Here’s how to perform punch-in/out using the keys of the transport section or a foot switch.

- 1 If you want to perform punch-in/out using a foot switch, connect a separately sold foot switch (Yamaha FC5 or equivalent) to the rear panel FOOT SW jack.**
- 2 Call the RECORD screen Direct page, and make sure that your instrument/mic is assigned to the track on which you want to punch-in.**
- 3 Locate to a point earlier than where you want to punch-in.**

For details on Locate operation, refer to “Move To a Specified Location” on page 87.

You may find it convenient to register a marker at a location one or two measures earlier than the point at which you want to punch-in, so you can quickly return to that point. (For details on registering a marker → p. 90)

- 4 Press the Transport section PLAY [▶] key. (Alternatively, press the foot switch.)**

The song will begin playing. At this time, the track playback sound of the recording-destination track channel will be sent to the stereo bus, so you will not be able to monitor the input signal.

- 5 At the point where you want to begin recording, hold down the PLAY [▶] key and press the REC [●] key (or press the foot switch once again), and begin playing your instrument.**

The recording-destination track will switch from playback to recording (“punch-in”).

- 6 At the point where you want to stop recording, press the PLAY [▶] key (or press the foot switch).**

The recording-destination track will switch from recording back to playback (“punch-out”).

- 7 To stop playback, press the STOP [■] key (or press the foot switch).**

The [UNDO/REDO] key in the data entry / control section will light.



- If no track has been enabled for recording, the foot switch will alternate between Play and Stop operations.

- 8 To listen to the newly-recorded content, locate to a point just before the punch-in point, and press the PLAY [▶] key.**

- 9 If you are satisfied with the newly-recorded content, save the song. (For details on saving → p. 57)**

If you decide to re-do the recording, press the [UNDO/REDO] key to cancel the recording, and repeat steps 3–7.

The following diagram shows the manual punch-in/out procedure.

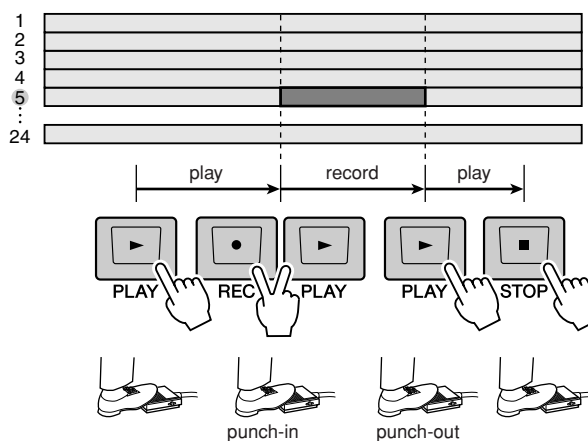

## Auto punch-in/out

Auto punch-in/out is a function that performs the punch-in and punch-out operations automatically. In order to use this function, you must first specify the punch-in location (the In point) and the punch-out location (the Out point).

**1 Call the RECORD screen Direct page, and make sure that your instrument/mic is assigned to the track on which you want to punch-in.**

**2 Locate to the point at which you want to punch-in.**

**3 Hold down the Locate section [SET] key and press the [IN] key.**

The current location will be registered as the In point.

**4 Locate to the point at which you want to punch-out.**

**5 Hold down the Locate section [SET] key and press the [OUT] key.**

The current location will be registered as the Out point.

### HINT

- If you want to set the In and Out points more precisely, you can use the Nudge function (→ p. 94) which repeatedly plays a short region before or after the current location, or use the WAVE DISPLAY popup window (→ p. 69) which lets you view the contents of the track as a waveform.
- The In point and Out point will be updated each time you record. The location at which you last started recording will be registered as the In point, and the location at which you last stopped recording will be registered as the Out point.

**6 Press the Locate section [AUTO PUNCH] key.**

The [AUTO PUNCH] key will light, and the Auto Punch-in/out function will be enabled. You will automatically locate to a point a specific distance (the “pre-roll time”) ahead of the In point. This point is called the “pre-roll point.”

### NOTE

- If the auto punch-in/out region is too short or too long (less than approximately 100 msec or greater than one hour), an error message will appear, and you won't be able to specify the Out point.
- You can't change the In/Out points if the [AUTO PUNCH] key is lit. If you need to change the In/Out points, you must first defeat the Auto Punch-in/out function.

**7 To rehearse the auto punch-in/out, press the PLAY [▶] key.**

When you press the PLAY [▶] key while the [AUTO PUNCH] key is lit, the following will occur.

- ① The PLAY [▶] key will light, and playback will begin from the pre-roll point.
- ② When you reach the auto punch-in point, the REC [●] key will begin blinking, and the signal that you are monitoring from the recording-destination track channel will switch from the track playback to the input signal (recording-source). (However, recording will not actually occur.)
- ③ When you reach the auto punch-out point, the REC [●] key will go dark, and the signal that you are monitoring from the recording-destination track channel will return to the track playback.
- ④ When you reach a point that is a specific distance (the “post-roll time”) after the Out point (this point is called the “post-roll point”), you will return to the pre-roll point and stop.

### HINT

- If you turn the Locate section [REPEAT] key on before step 7, operations 1–4 of step 7 will be repeated up to fifteen times. (The A-B Repeat function is disabled during this time.) If you want to stop repeating the rehearsal, press the [REPEAT] key once again or press the STOP [■] key.
- With the initial settings of the AW2400, the pre-roll and post-roll times are each set to four seconds. You can adjust these values in a range of 0–20 seconds (→ p. 210, 211).

**8 To perform the actual auto punch-in/out, stop the recorder, then hold down the REC [●] key and press the PLAY [▶] key.**

When you press the REC [●] key + PLAY [▶] key while the [AUTO PUNCH] key is lit, the following will occur.

- ① Only the PLAY [▶] key will light, and playback will begin from the pre-roll point.
- ② When you reach the auto punch-in point, the REC [●] key will light, and recording will begin (“punch-in”).
- ③ When you reach the auto punch-out point, the REC [●] key will go dark, recording will stop, and you will return to playback mode (“punch-out”).
- ④ When you reach the post-roll point, you will return to the pre-roll point and stop. At this time, the [UNDO/REDO] key in the data entry / control section will light.

**9 To check the newly-recorded content, press the [AUTO PUNCH] key to make it go dark, and then press the PLAY [▶] key.**

**10** If you are satisfied with the newly-recorded content, save the song. (For the Save procedure → p. 57)

If you decide to re-do the recording, you can go back to the best take using the Undo list after performing several overdubs by repeating steps 6–9 (→ p. 64).

The following diagram shows the auto punch-in/out procedure.

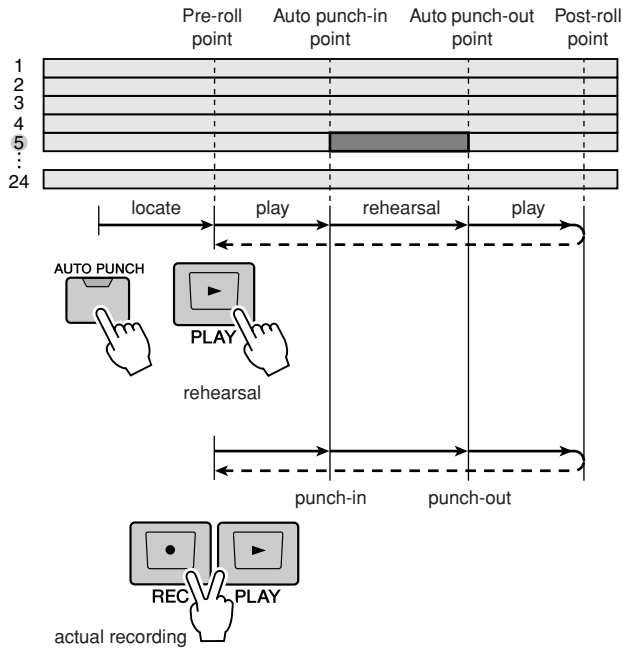

# 7

## Overdubbing



# Mixdown and bounce operations

This chapter explains mixdown operations, in which you mix previously-recorded tracks and record the result on the stereo track. This chapter also explains how bouncing (ping-pong recording), in which you combine multiple tracks into one to four tracks.

## About mixdown and bouncing

“Mixdown” is the process by which the signals recorded on the recorder tracks are mixed to stereo, and recorded on the internal stereo track to complete the song. The contents of the stereo track can be used without further processing as material to create an audio CD.

The diagram below shows the signal flow during mixdown. The playback of each track is sent to the stereo bus, passes through the stereo output channel, and is recorded on the stereo track. At this time you can also add the signals from input channels.

### ● Signal flow during mixdown

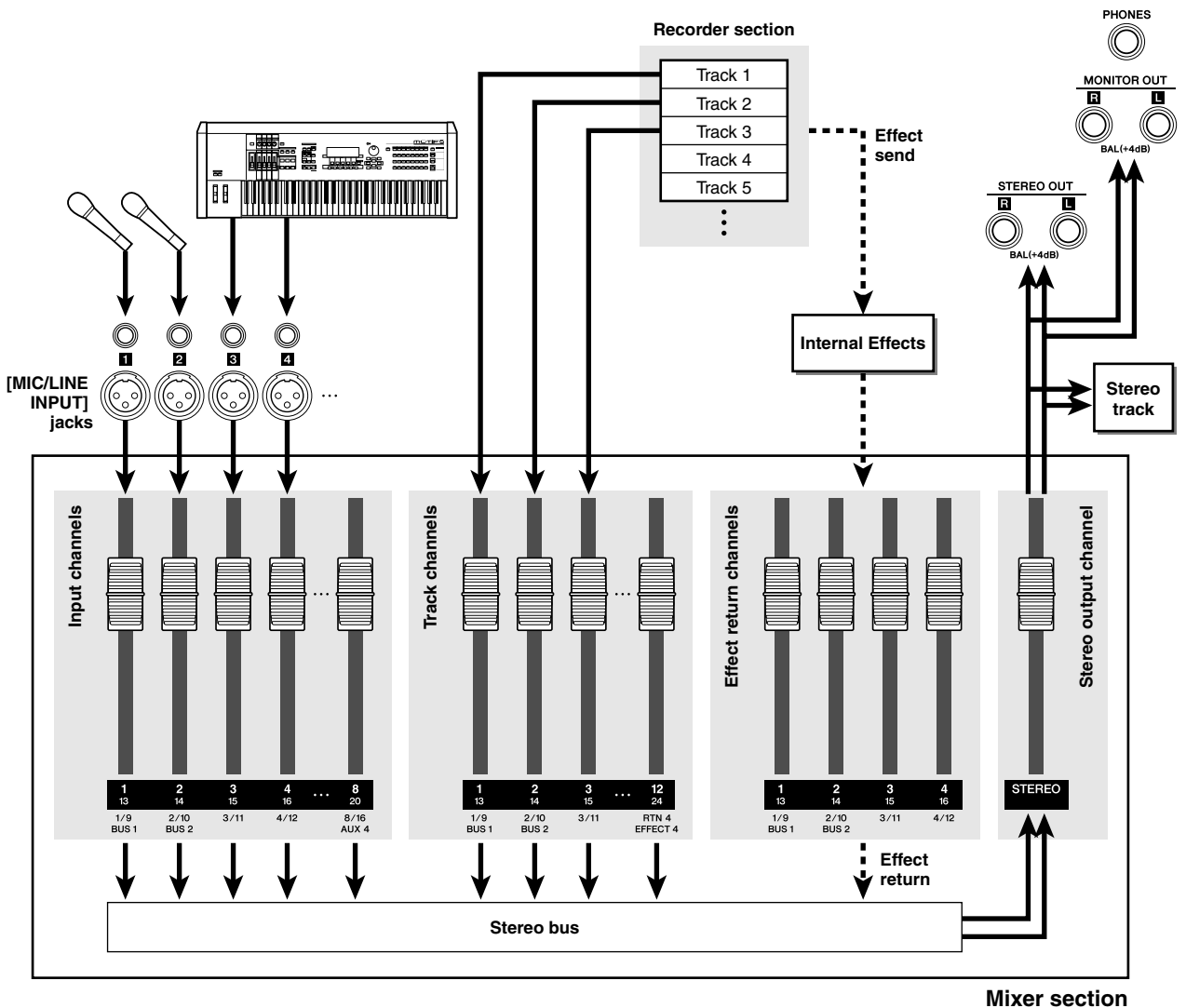

“Bouncing” is the action of mixing the signals recorded on multiple tracks, and recording the mixed result into one to four vacant tracks. (This action is also called “ping-pong recording.”) For example if you’ve recorded individual instruments of a drum set on multiple tracks, you can bounce these tracks down to two tracks, and then switch the bounce-source tracks to different virtual tracks so that they will be free to record new instruments. Bouncing differs from mixdown in the following ways.

- The destination of the track channels is Bus 1/Bus 2 rather than the stereo bus.
- The recording-destination will be a vacant audio track (or tracks).
- You can’t add the signals of input channels.

The diagram below shows the signal flow during bouncing. This diagram shows an example in which the track 1–8 signals are bounced to tracks 9–12. After bouncing, you can switch the virtual tracks for tracks 1–8, and use these tracks to record other instrumental performances.

● Signal flow during bouncing

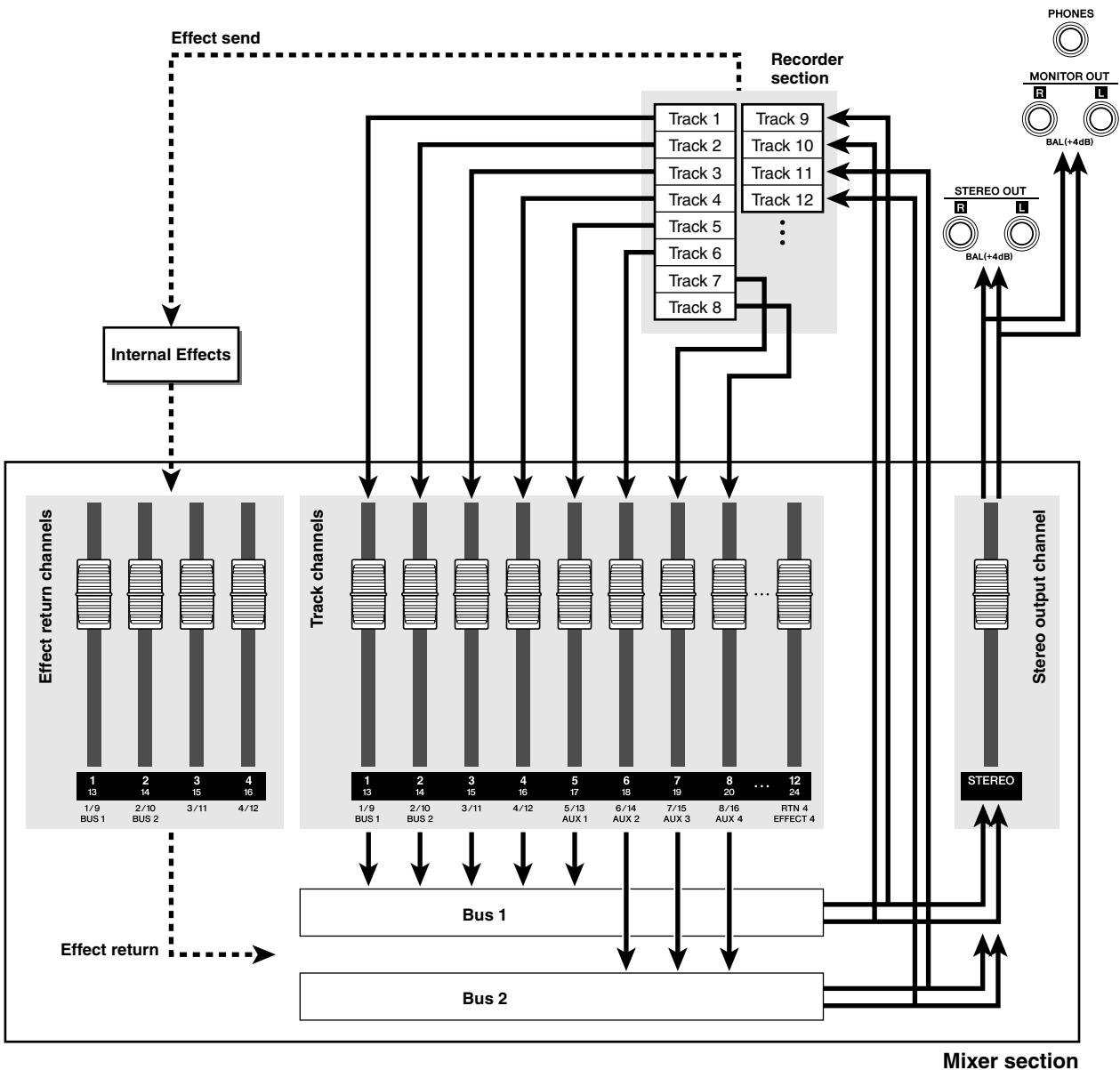

# Mixdown procedure

In this procedure you will select the channels that you want to mix down (track channels, input channels, and effect return channels), and record them to the stereo track.

- 1 Lower the [STEREO] fader to the  $-\infty$  position.
- 2 Call the RECORD screen Mixdown page by either pressing the Quick Navigate section [RECORD] key as many times as necessary, or by pressing the [F4] key after pressing the [RECORD] key.

The Mixdown page is where you can perform mixdown operations. In this page you can select the channels that will be recorded via the stereo bus onto the stereo track.

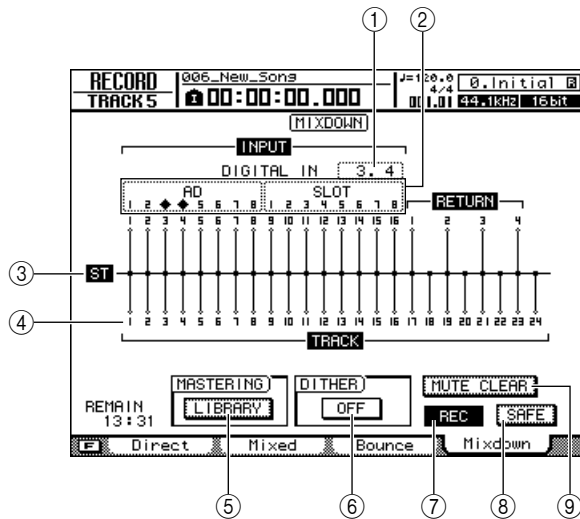

**1 DIGITAL IN**

This lets you assign an input channel to the [DIGITAL STEREO IN] connector.

Here you can choose from the following items.

- 1.2–15.16 ..... The signal from the [DIGITAL STEREO IN] connector will be assigned to adjacent odd-numbered/even-numbered input channels 1/2–15/16.
- --- ..... The [DIGITAL STEREO IN] connector will not be used.



- In order for the digital audio signal sent from an external device to the [DIGITAL STEREO IN] connector to be assigned to an input channel, the clock of the external device and the AW2400 must be synchronized (→ p. 223).
- The DIGITAL IN setting takes priority over the setting of the Input Select field. If you assign DIGITAL IN to an input channel, a  $\blacklozenge$  symbol will be displayed for the two corresponding input numbers in the Input Select field. This symbol indicates that DIGITAL IN is assigned.
- If the STEREO BUS CASCADE button in the DIO screen Setting page is set to ENABLE, "ST BUS" will appear as the DIGITAL IN assignment, and the assignment can't be changed.

**2 Input Select**

Here you can select the input sources that will be patched to input channels 1–8 or 9–16. You can select the following input sources.

- AD1–8 ..... The input signals from the AD inputs ([MIC/LINE INPUT] jacks 1–8)
- SLOT1–8 ..... The input signals from inputs 1–8 of the digital I/O card
- SLOT9–16 ..... The input signals from inputs 9–16 of the digital I/O card
- --- ..... Not selected

**3 Stereo bus**

Indicates the on/off status of the channels being sent to the stereo bus. The numbers within the screen correspond to the following channels.

- INPUT 1–16 ..... Input channels 1–16
- RETURN 1–4 ..... Effect Return channels 1–4
- TRACK 1–24 ..... Track channels 1–24

**4 Tracks**

This is the track channel number. Move the cursor to the number and press the [ENTER] key to switch track muting on/off.

**5 LIBRARY button**

Accesses the mastering library, where you can recall EQ and dynamics settings specifically for the stereo output channel.

**6 DITHER ON/OFF button**

This is an on/off switch for "dithering," which is a process that reduces the perceived quantization noise when you convert a digital audio signal to a lower bit depth.

**7 REC button**

Puts the stereo track in record-ready mode.

**8 SAFE button**

Defeats the record-ready state of the stereo track. This will also execute MUTE CLEAR (9).



- Pressing the [F1] key while holding the Display section [SHIFT] key has the same effect as the SAFE button.

**9 MUTE CLEAR button**

This clears the Mute status of all tracks.

However depending on the bit depth of the song, there may be cases in which some tracks cannot be unmuted. If so, tracks will be muted consecutively starting with the last-numbered track.

**3 Use the Layer section keys, the [INPUT SEL] keys, and the [SEL] keys to select the channels that you want to send to the stereo bus.**

For example, repeatedly pressing [INPUT SEL] key 1 (or the [SEL] key of input channel 1) will make the screen change as follows.



**NOTE**

- The track numbers of muted tracks will be displayed as **M** (mute).
- Since 24-bit songs can have a maximum of 12 play tracks (→ p. 165), tracks 13–24 are muted and will not play back.
- You can switch track muting on/off by moving the cursor to the track channel number and pressing the [ENTER] key.
- If you're using effects via an effect bus, the mixdown will not include the effect sound unless you add the corresponding effect return channel to the stereo bus. For details on using effects, refer to "Applying Effects via Send and Return" (→ p. 117).

**HINT**

- All channels will be turned on by default. However in order to obtain the best S/N ratio, you should turn off any channels that you are not using.

**4 Raise the [STEREO] fader to the 0 dB position.**

**5 While you play back the song, raise the track channel faders to an appropriate level.**

**6 Adjust the mix parameters of each channel, such as EQ, dynamics, and pan.**

**HINT**

- You can use the CH VIEW screen View page to view a list of the mix parameters (EQ, pan, effect send etc.) of a desired channel (→ p. 105).

**7 If you want to use the mastering library, move the cursor to the LIBRARY button and press the [ENTER] key.**

The MASTERING LIBRARY popup window will appear.

You can use the mastering library to quickly recall dedicated settings for the stereo output channel. These settings include EQ and dynamics processor settings that are appropriate for application to the final mix. Library numbers 0–13 are read-only, and library number 0 is data to initialize the stereo output channel.



**8 Use the [DATA/JOG] dial or [INC]/[DEC] keys to select the desired library data, then move the cursor to the RECALL button and press the [ENTER] key.**

The mastering library settings will be recalled. Play back your song while you try various settings to find the best one.

To exit the MASTERING LIBRARY popup window, move the cursor to the EXIT button and press the [ENTER] key.

**9 If necessary, you can press the [STEREO SEL] key to select the stereo output channel, and use the Selected Channel section to make fine adjustments to the EQ and dynamics processor settings.**

Operations are the same as for an input channel, except for the fact that the EQ and dynamics processor of the stereo output channel always operate in stereo, and that the dynamics processor has no gate.

- 10 To check the level of the signal that is being output to the stereo track, press the [METER] key, then press the [F3] key.

The METER screen Master page will appear.

Indicates the output level of the stereo output channel

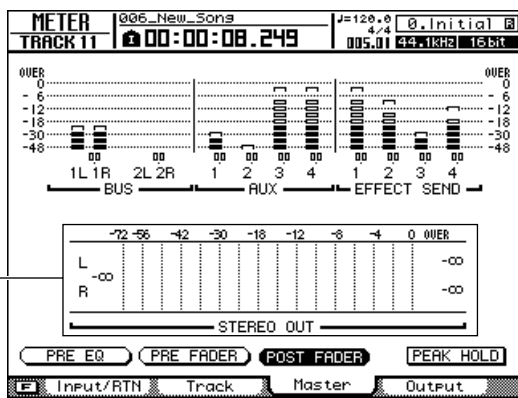

- 11 Move the cursor to the POST FADER button and press the [ENTER] key.

The post-fader signal level will be displayed.

If the level meter reaches the “OVER” position, lower the [STEREO] fader.

- 12 Press the [RECORD] key to return to the RECORD screen Mixdown page.

- 13 Move the cursor to the REC button, and press the [ENTER] key to turn the button on.

The top panel [STEREO SEL] key will blink red. This blinking indicates that the stereo track is in record-ready mode.

- 14 Press the RTZ [⏮] key to rewind the song. Then hold down the REC [●] key and press the PLAY [▶] key.

The song will begin playing, and the playback will be recorded on the stereo track.

- 15 When you reach the end of the song, move the cursor to the SAFE button in the screen and press the [ENTER] key.

A popup window will ask you to confirm that you want to cancel record-ready mode. Move the cursor to the OK button and press the [ENTER] key.

HINT

• Instead of using the AW2400's internal stereo track, you can also mixdown to an external recorder connected to the [STEREO OUT] jacks or [DIGITAL STEREO OUT] connector. In this case, start playback on the AW2400 after you've put your external recorder in record mode.

- 16 Save the song.

If the song is not saved after it has been recorded as a stereo track, it cannot be selected for burning to a CD.

## Playing back the stereo track

When you've finished the mixdown, you can play back the stereo track as follows.

- 1 Call the TRACK screen Stereo TR page by either pressing the Work Navigate section [TRACK] key as many times as necessary, or by pressing the [F3] key after pressing the [TRACK] key.

ST TR MODE ON/OFF button

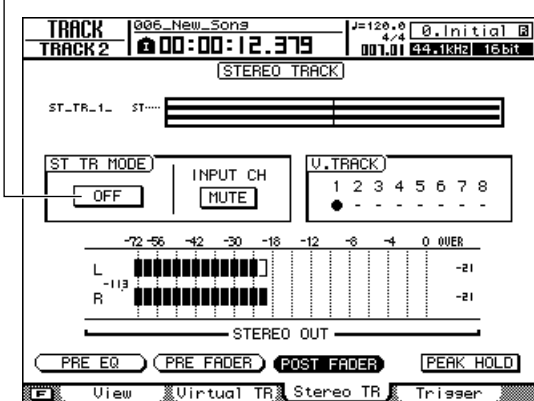

- 2 Switch the ST TR MODE ON/OFF button ON.

When this button is on, the stereo track output will be sent to a point directly before the [STEREO] fader, and can be monitored from the [STEREO OUT] jack, the [MONITOR OUT] jack, or the [PHONE] jack. At this time, the record-ready status of all tracks will be cancelled.

**HINT**

- If any audio tracks are in record-ready mode, a popup window will ask you to confirm that you want to defeat the record-ready status. If you want to play back the stereo track, move the cursor to the OK button and press the [ENTER] key.

**NOTE**

- The EQ and dynamics processor of the stereo output channel are disabled while the stereo track is playing back.

- 3 Press the RTZ [⏮] key to rewind the song, and press the PLAY [▶] key.

The stereo track will be played back. Use the [STEREO] fader to adjust the monitor level.

- 4 When you are ready to return to normal recording/playback of the audio tracks, switch the ST TR MODE ON/OFF button off.

# Bounce (ping-pong) recording procedure

Here's how to bounce (ping-pong) multiple tracks down to one to four tracks.

- 1 Lower the [STEREO] fader to the  $-\infty$  position.
- 2 Call the RECORD screen Bounce page by either pressing the Quick Navigate section [RECORD] key as many times as necessary, or by pressing the [F3] key after pressing the [RECORD] key.

In the Bounce page you can select the bounce-source tracks, and then record them via bus 1 or bus 2 onto one to four tracks.

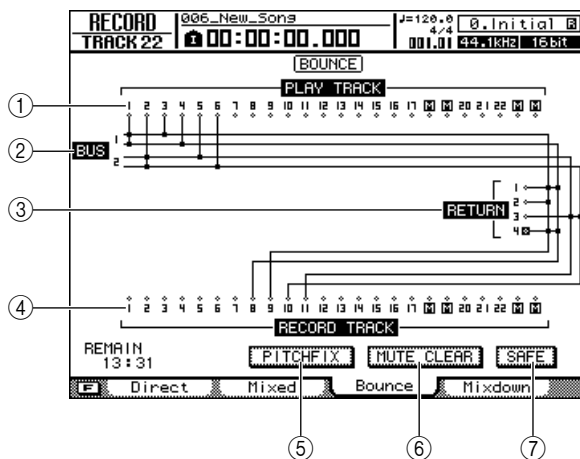

- 1 **PLAY TRACK**  
Selects the bounce-source tracks.
- 2 **Bus 1, Bus 2**  
The four horizontal lines indicate the Bus1 L/R and Bus2 L/R signal route. This lets you see the on/off status of the signals that are sent from the bounce-source tracks, and see the selected bounce-destination track(s).
- 3 **RETURN**  
Selects the bounce-source effect return channels.
- 4 **RECORD TRACK**  
Here you can select the bounce-destination track(s).
- 5 **PITCH FIX button**  
Position the cursor at this button and press [ENTER] to engage the PITCH FIX mode. Use PITCH FIX to correct the pitch and other properties of a vocal track (→ p. 124).
- 6 **MUTE CLEAR button**  
This button clears the mute status of all tracks.  
However depending on the bit depth of the song and on the number of tracks that are enabled for recording, there may be cases in which some tracks cannot be unmuted. If so, tracks will be muted consecutively starting with the last-numbered track.

## 7 SAFE button

When you move the cursor to this button and press the [ENTER] key, all bounce-source and bounce-destination assignments will be cancelled. This will also execute the MUTE CLEAR (6) operation.



- Pressing the [F1] key while holding the Display section [SHIFT] key has the same effect as the SAFE button.

- 3 In the PLAY TRACK area, select a bounce-source track, move the cursor to the  $\diamond$  symbol for that track, and press the [ENTER] key.

Each time you press the [ENTER] key, the screen will change as follows.

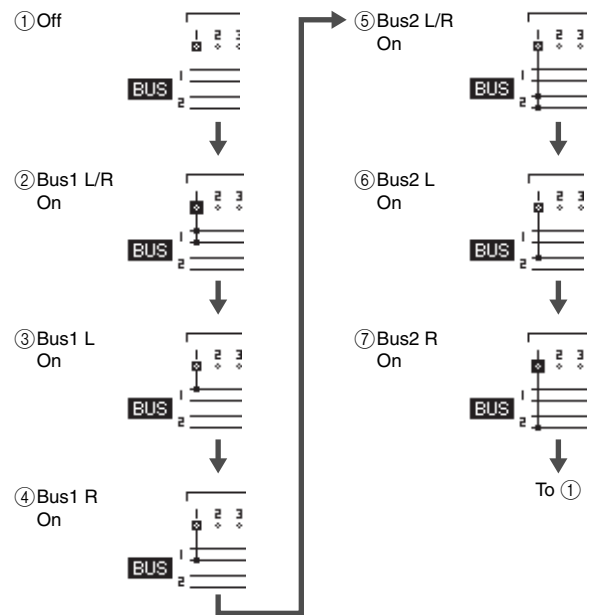

- If a track channel is selected as a bounce-source, its assignment to the stereo bus will automatically be turned off.
- The track numbers of muted tracks will be displayed as  $\blacksquare$  (mute), but you can still record to muted tracks.
- Since 24-bit songs can have a maximum of 12 play tracks (→ p. 165), tracks 13–24 are muted and will not play back.
- To switch track muting on/off, move the cursor to a track channel number and press the [ENTER] key.

#### 4 If you want to add an effect return channel as a bounce-source, press the [SEL] key of that effect return channel.

In the same way as for PLAY TRACK in step 3, you can repeatedly press the [SEL] key to select the bus to which the signal is sent.

**NOTE**

- If you are using an effect via an effect bus, the bounce operation will not include the effect sound unless you add the signal of the corresponding effect return channel to the bounce-destination bus. For details, refer to "Applying Effects via Send and Return" (→ p. 117).

**HINT**

- To control the effect return channels, make the Layer section [IN 1-8] key (or [IN 9-16] key) light.

#### 5 In the RECORD TRACK area, select a bounce-destination track, move the cursor to the ◊ symbol for that track, and press the [ENTER] key.

You can select up to four bounce-destination tracks. The odd-numbered tracks can be connected to Bus 1 L or Bus 2 L, and the even-numbered tracks can be connected to Bus 1 R or Bus 2 R. The [SEL] key will blink red, indicates that the corresponding track is selected as the bounce-destination.

In the same way as for the PLAY TRACK, you can repeatedly press the [ENTER] key to select the signal of the desired input bus.

For example if you move the cursor to the ◊ symbol for RECORD TRACK 1 and repeatedly press the [ENTER] key, the screen will change as follows.

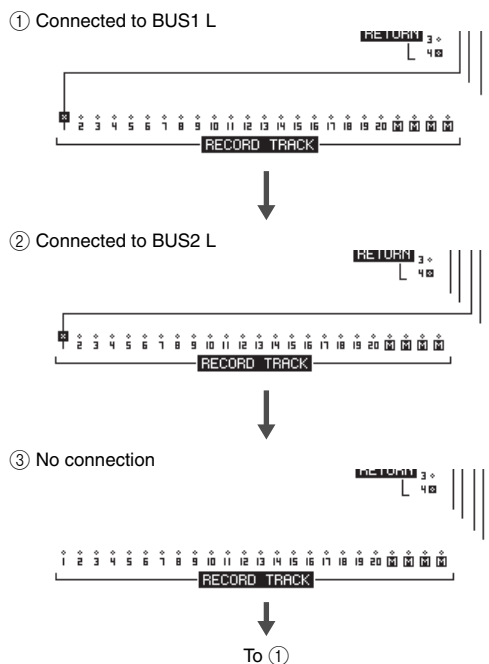

**HINT**

- You can also select a track by repeatedly pressing the [SEL] key of a track channel.
- If you move the cursor to the SAFE button and press the [ENTER] key, all connections will be cancelled.
- The track numbers of muted tracks will be displayed as [M] (mute), but you can still record to muted tracks.
- If an unpaired track is selected as a recording-destination, the pan of the corresponding track channels will be set to the center. If two paired tracks are selected, the pan of the corresponding odd-numbered/even-numbered track channels will be spread to left and right respectively.

#### 6 Raise the [STEREO] fader and the faders of the track channel(s) you selected as the bounce-destination to the 0 dB position.

#### 7 Press the RTZ [◀] key to rewind the song. Then hold down the REC [●] key and press the PLAY [▶] key.

The song will begin playing back, and will be recorded on the bounce-destination track(s).

#### 8 While you record the song, raise the faders of the bounce-source track channels and effect return channels to an appropriate level. Adjust the pan, EQ, and dynamics of each channel as necessary.

**NOTE**

- The bounce-destination faders and pans will not affect the content that is recorded.
- When Auto Punch-in/out is engaged, you can monitor the bounce source track channels during playback even when not recording.

#### 9 To check the level that is being output from Bus 1/Bus 2 to the bounce-destination tracks, press the [METER] key and then the [F3] key.

The METER screen Master page will appear. Here you can check the output levels for Bus 1 and Bus 2.

Bus 1 and Bus 2 output levels

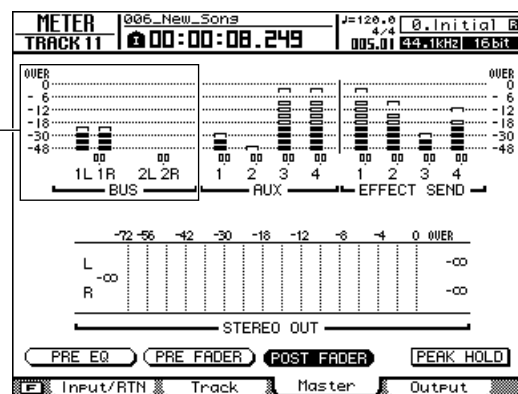



**10 Move the cursor to the POST FADER button, and press the [ENTER] key.**

The post-fader signal levels will be displayed.

If the level meter reaches the “OVER” position, press the Layer section [MASTER] key to make it light (the MASTER mixing layer is selected), and lower fader 1 (Bus 1) and fader 2 (Bus 2).

**NOTE**

- All of the current patch settings will be erased if you switch the RECORD screen page after making signal assignments. (A popup window will ask you whether you really want to erase the assignments.) Be careful not to switch the RECORD screen page until you've finished recording.

**11 To stop bounce-recording, press the STOP [■] key.****12 To hear the bounce-recorded results from the beginning, press the RTZ [◀] key to return the counter display to zero, and then press the PLAY [▶] key.**

When playing back the bounce-destination tracks, be careful not to switch the RECORD screen to a page other than the Bounce page or to defeat the bounce settings.

If you do so, the connection from the bounce-source track channels to the stereo bus will automatically be restored. This will cause the bounce-source and bounce-destination signals to be duplicated.

**HINT**

- If desired, you can use the [UNDO/REDO] key to cancel the bounce-recording operation (→ p. 64), or switch the virtual track of the bounce-destination and record another take (→ p. 63).

**13 When you've finished the bounce operation, press the Quick Navigation section [RECORD] key once again, move the cursor to the SAFE button in the screen, and press the [ENTER] key.**

A popup message will ask you for confirmation. Move the cursor to the OK button and press the [ENTER] key to defeat all bounce settings.

## Convenient functions for mixdown/bounce

Here we will explain some functions that you will find convenient when performing mixdown or bounce operations.

### Fader Group assignments

Fader Grouping is a function that links the fader operations of multiple channels. For example if you've recorded multiple track channels of drums or chorus, you can assign these drum channels or chorus channels to the same fader group so that moving any one of the faders in the group will adjust all of the levels together.

- 1 Call the MONITOR screen Fader Grp. page by either pressing the Quick Navigate section [MONITOR] key as many times as necessary, or by pressing the [F2] key after pressing the [MONITOR] key.

This page contains the following items.

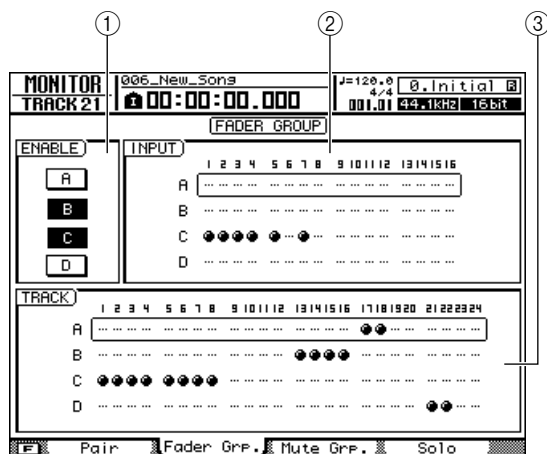

① **ENABLE field**

Use these buttons to switch fader groups A–D on/off. The A–D buttons will be highlighted to indicate fader groups that are turned on. You will also use this field to select the fader group that you want to operate.

② **INPUT field**

③ **TRACK field**

These areas indicate the fader group to which each input channel 1–16 and track channel 1–24 is assigned. The “●” symbol indicates channels that are assigned, and the “...” symbol indicates channels that are not assigned.

- 2 In the ENABLE field, move the cursor to the button A–D of the fader group that you want to operate.

- 3 Use the Layer section keys, the [INPUT SEL] keys, and the [SEL] keys to select the channels that you want to assign to this fader group.

The assignment to the fader group will alternately be switched on or off each time you press the [INPUT SEL] key or [SEL] key.

**HINT**

- If you want to defeat all assignments for the fader group you're currently operating, hold down the Display section [SHIFT] key and press the [F1] key.
- If you want to defeat all assignments in the Fader Grp. page, hold down the [Display section [SHIFT] key and press the [F2] key.

- 4 Repeat steps 2–3 to make assignments for other fader groups.

**NOTE**

- You can't assign a single channel to more than one fader group.

- 5 To enable a fader group, move the cursor to the A–D buttons and press the [ENTER] key.

Buttons A–D can be turned on/off independently.

- 6 Operate a channel that is assigned to a fader group.

The faders of all channels assigned to that fader group will move in tandem.

**NOTE**

- When operating channels that are assigned to a fader group, you must use only one fader. If you attempt to move two or more faders simultaneously, the motor faders will be stressed, and possibly damaged.

**HINT**

- If you want to adjust the fader value for only a specific channel that is assigned to a fader group, operate its fader while holding down the [SEL] key or [INPUT SEL] key for that channel.
- The fader group assignments are available even when Trigger Track mode is engaged.
- The fader group assignments in the Fader Grp. page can be copied to the Mute Grp. page by holding down the Display section [SHIFT] key and pressing the [F4] key.

## Mute Group assignments

Mute Grouping is a function that links the [ON] key operations of multiple channels. This lets you mute multiple instruments by pressing a single [ON] key, or press a single key to alternate the on/off status of multiple track channels.

- 1 Call the MONITOR screen Mute Grp. page by either pressing the Quick Navigate section [MONITOR] key as many times as necessary, or by pressing the [F3] key after pressing the [MONITOR] key.

This page contains the following items.

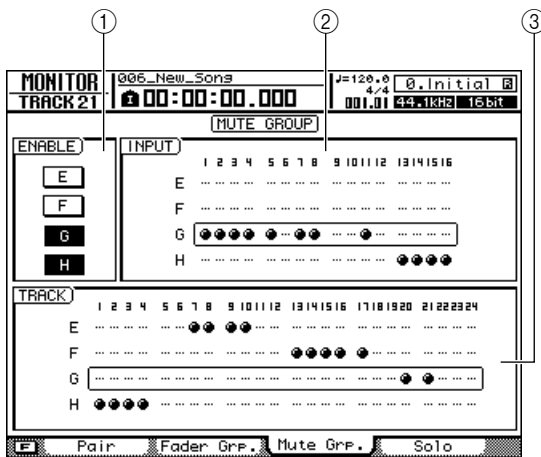

① **ENABLE field**

Use these buttons to switch mute groups E–H on/off, or to select the mute group that you want to operate. The E–H buttons will be highlighted to indicate mute groups that are turned on.

② **INPUT field**

③ **TRACK field**

These areas indicate the mute group to which each input channel 1–16 and track channel 1–24 is assigned. The “●” symbol indicates channels that are assigned, and the “...” symbol indicates channels that are not assigned.

- 2 In the ENABLE field, move the cursor to the button E–H of the mute group that you want to operate.

- 3 Use the Layer section keys, the [INPUT SEL] keys, and the [SEL] keys to select the channels that you want to assign to this mute group.

The assignment to the mute group will alternately be switched on or off each time you press the [INPUT SEL] key or [SEL] key.

HINT

- If you want to defeat all assignments for the mute group you're currently operating, hold down the Display section [SHIFT] key and press the [F1] key.
- If you want to defeat all assignments in the Mute Grp. page, hold down the [Display section [SHIFT] key and press the [F2] key.

- 4 Repeat steps 2–3 to make assignments for other mute groups.

NOTE

- You can't assign a single channel to more than one mute group.

- 5 To enable a mute group, move the cursor to the E–H buttons and press the [ENTER] key. Buttons E–H can be turned on/off independently.

- 6 Operate a channel that is assigned to a mute group.

The [ON] keys of all channels assigned to that mute group will operate simultaneously.

HINT

- If you make mute group assignments while the [ON] keys of the assigned channels are in a mixed state (some on, some off), the on/off setting of each channel will alternate.
- The mute group assignments in the Mute Grp. page can be copied to the Fader Grp. page by holding down the Display section [SHIFT] key and pressing the [F4] key.

## Using the Solo function

Solo is a function that lets you monitor only a specific channel. The AW2400 provides a versatile Solo function that lets you make Solo settings that are best for your situation.

- 1 Call the **MONITOR screen Solo page** by either pressing the **Quick Navigate section [MONITOR] key** as many times as necessary, or by pressing the **[F4] key** after pressing the **[MONITOR] key**.

This page contains the following items.

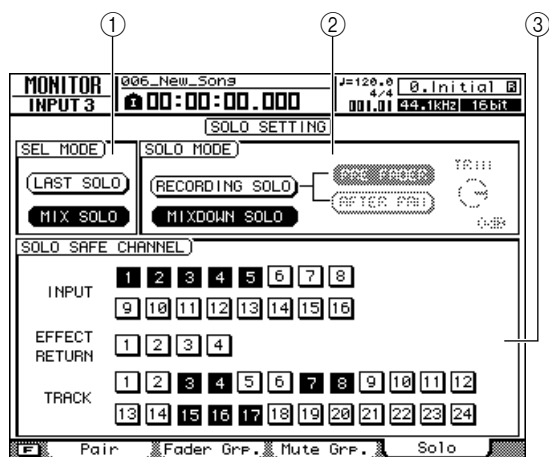

① **SEL MODE field**

This selects how you will select the signal(s) to be monitored when the Solo function is on.

② **SOLO MODE field**

This selects the mode in which the Solo function will operate.

③ **SOLO SAFE CHANNEL field**

Here you can select channels that will be excluded from the Solo function if MIXDOWN SOLO mode is selected in the SOLO MODE field.

- 2 In the **SEL MODE field**, choose the way in which the signal(s) to be monitored will be selected when the Solo function is on.

You can turn on one or the other of the following buttons.

- **LAST SOLO button**

If this button is on, you will be monitoring only the single channel whose [ON] key was last pressed.

- **MIX SOLO button**

If this button is on, you will be monitoring all channels whose [ON] key was pressed after enabling the Solo function.

- 3 Use the **SOLO MODE field** to choose the operating mode for the Solo function.

You can turn on one or the other of the following buttons.

- **RECORDING SOLO button**

If this button is on, the soloed signal(s) will be sent via the dedicated Solo bus and output from the [MONITOR OUT] jacks and [PHONES] jack. This will not affect the signals that are being output from the stereo bus or Bus 1/Bus 2. With this setting, even channels that are not assigned to the stereo bus or Bus B/bus 2, or channels whose [ON] key is off, can be monitored from the [MONITOR OUT] jacks or [PHONES] jack.

This setting is convenient when you want to monitor only specific channels without affecting the recorded content while recording tracks or during mixdown.

- **MIXDOWN SOLO button**

If this button is on, only the soloed signal(s) will be sent via the stereo bus and output from the [STEREO OUT] jacks, [MONITOR OUT] jacks, and [PHONES] jack; other channels will be muted. With this setting, you won't be able to monitor channels that are not assigned to the stereo bus, or channels whose [ON] key is turned off.

This setting is convenient when you want everything except for the specified channel(s) to be muted.

- 4 If you selected **RECORDING SOLO mode** in step 3, use the **SOLO MODE field** to select the point from which the soloed signal will be sent.

Use the following two buttons of the SOLO MODE field to select the send point.

- **PRE FADER button**

If this button is on, the pre-fader signal will be sent to the Solo bus. In this case, the fader and pan settings of each channel will be ignored, and the signal that is output from the [MONITOR OUT] jacks and the [PHONES] jack will be monaural.

- **AFTER PAN button**

If this button is on, the post-fader post-pan signal will be sent to the Solo bus. In this case, the fader and pan setting of each channel will affect the signal that is sent from the [MONITOR OUT] jacks and the [PHONES] jack.



• If **RECORDING SOLO mode** is selected, you can turn the **SOLO MODE field's TRIM knob** to adjust the signal level sent to the Solo bus.

**5 If you selected MIXDOWN SOLO mode in step 3, you can (if desired) select channels that will be excluded from Solo operations.**

Use the buttons in the SOLO SAFE CHANNEL field to specify the channels that will be excluded from Solo operations. Move the cursor to a desired button and press the [ENTER] key (you may select more than one). These buttons correspond to the following channels.

- **INPUT** .....Input channels 1–16
- **EFFECT RETURN** .....Effect return channels 1–4
- **TRACK**.....Track channels 1–24

The channels you select here will not be muted even if you turn on the Solo function. If you select effect return channels 1–4 here, you'll be able to monitor with effects even when the Solo function is on.

**6 To activate the Solo function, press the Mixer section [SOLO] key.**

The [SOLO] key and the [ON] key of the selectable channels will blink.

**7 Use the Layer section keys and [ON] keys to select the channels that you want to solo.**

The operations that are valid while Solo is activated will depend on the settings in the MONITOR screen Solo page.

**8 To defeat the Solo function, press the [SOLO] key once again.**



# ◆ Chapter 9 ◆

## Transport/Locate Operation

This chapter covers transport key operation, use of the locate/marker functions, and a range of other playback features.

### The Transport Section Keys

The functions of the Transport section keys change according to the current state of the recorder (playback, stopped, etc.), as listed in the chart below.

Key	Recorder Status				
	Playing	Stopped	Rewinding	Fast Forwarding	Recording
PLAY[▶] key	—	Play	Play	Play	Stop record and play (Punch Out)
STOP[■] key	Stop	—	Stop	Stop	Stop
REW[◀◀] key	Rewind	Rewind	Rewind speed (8x ↔ 16x)	Rewind	—
FF[▶▶] key	Fast forward	Fast forward	Fast forward	Fast forward speed (8x ↔ 16x)	—
RTZ[◀] key	Return to zero and play	Return to zero and stop	Return to zero and play or stop (depending on Play/Stop status prior to rewind)	Return to zero and play or stop (depending on Play/Stop status prior to fast forward)	—
REC[●] key	Press simultaneously with PLAY [▶] key to begin recording (Punch In)	Press simultaneously with PLAY [▶] key to begin recording	—	—	—

The REC [●] key has no effect if no tracks are set to the record standby mode.

9

Transport/Locate Operation

### Move To a Specified Location

The AW2400 allows you to move directly to any location in a song by numerically specifying the desired locate point.

- 1 With the recorder stopped, press the **Locate/Number section [NUM.LOCK] key** so that its indicator lights.

A popup window will appear into which you can enter the destination locate point.

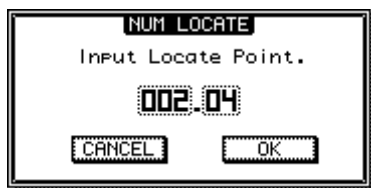

- 2 Enter the locate point in measures/beats.

You can use either of the following two methods to enter the locate point.

- Use the [DATA/JOG] dial or [INC]/[DEC] keys

Move the cursor to the measure or beat field, and use the [DATA/JOG] dial or [INC]/[DEC] keys to set as required.

● Use the [LOCATE] keys

The locate point can also be numerically entered directly using the [LOCATE] keys 1–9. Move the cursor to the measure or beat field and use the [LOCATE] 1–9 keys to enter the locate point numerically.

The “.” key can be used to quickly move the cursor between the beat and measure fields.

3 When the locate point has been specified press the [ENTER] key.

As long as the cursor is not on the CANCEL button pressing the [ENTER] will execute the move to the specified location. If you move the cursor to the CANCEL button and press the [ENTER] key no change in location will occur and the popup window will close.

## Using the locator

“Locate points” can be specified within a song in order to execute functions such as auto punch-in/out and A-B repeat. You can use this function to “locate” (move the current location of the song) to one of these points just by pressing a single key. On the AW2400, you can use the following locate points.

● In/Out points

These locate points are used to specify the region for auto punch-in/out (→ p. 70). Normally, the beginning and end of the recording you last performed will be automatically set as the In point and Out point. However, you may change these points as desired.

● A/B points

These locate points are used to specify the region for the A-B Repeat function (→ p. 93). The A point and B point can be set to any point in a song, either via the panel keys or on-screen editing.

● Quick Locator points

Locate/Number section [LOCATE] keys 1–9 can be assigned to specific locations within a song, and then you can move directly to the assigned locations simply by pressing the corresponding [LOCATE] keys.

● Start/end points

These locate points normally correspond to the beginning and end of the song. When you create a new song, the Start point will initially be set to absolute time 00:00:00.000. When you record, the end of the song will automatically be set as the End point. If you record past the previously-set End point, the End point will automatically be adjusted to the new song end point. If you select SECOND or TIME CODE as the counter display format, the Start point will be the origin (“zero point”) of the time and time code that are displayed. This means that if you change the Start point, the display will change accordingly, depending on the counter display format.

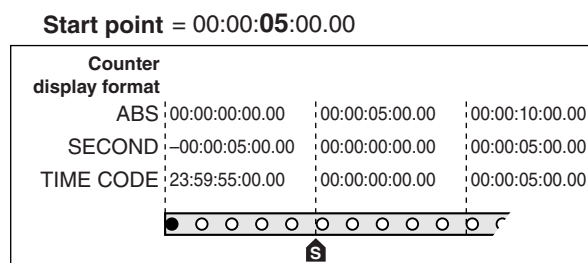
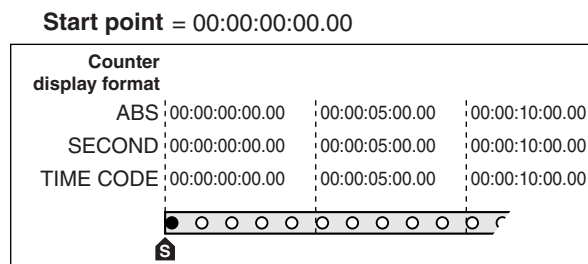

HINT

- When you create an audio CD, the Start and End points can be used to specify the region of the stereo track that will be written to the audio CD (→ p. 214).
- When the AW2400 transmits MTC to an external device, the Start point will be the origin (“zero point”) of the time code that is generated. The Start point will also serve as the origin (measure 1 beat 1) for the measures displayed in the counter.

● Relative zero point

This locate point stores the relative zero position. You will move to this location when you press the RTZ [ ◀ ] key in the transport section. Initially the relative zero point will be the same as absolute time 00:00:00.000, but you can change this if desired via the panel controls or on-screen editing. If you select RELATIVE as the counter display format, the current location will be displayed with the Relative Zero point as 0.



The procedure for registering the current location in one of the locate points, and then moving to that locate point is as follows.

**1 Move the song to the point that you want to register as a locate point.**

You can set locate points while the song is playing or stopped.

**2 Hold down the [SET] key and press the key for the desired locate point.**

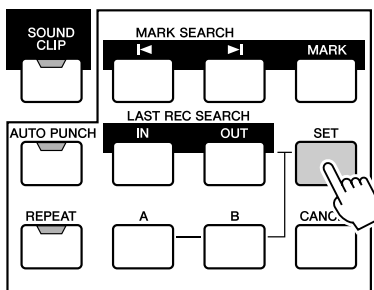

The locate points correspond to the following keys.

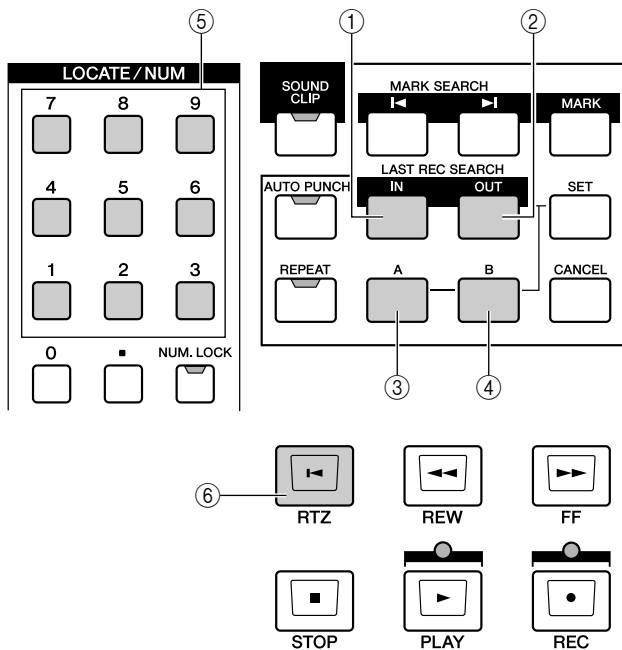

- ① [IN] key ..... In point
- ② [OUT] key ..... Out point
- ③ [A] key ..... A point
- ④ [B] key ..... B point
- ⑤ [LOCATE] key 1-9..... Quick Locator points
- ⑥ RTZ [ ◀ ] key ..... Relative Zero point

**NOTE**

- The In point and Out point will be updated automatically when you perform a record operation.
- If you want to change the Start point or End point, use the EDIT screen Mark Adj. page. These points cannot be set directly via the panel controls.

**3 To move to a registered locate point, press the corresponding key while the song is stopped or playing.**

The song will move to that location.

Registered locate points are displayed in the TRACK screen Track View page as shown below.

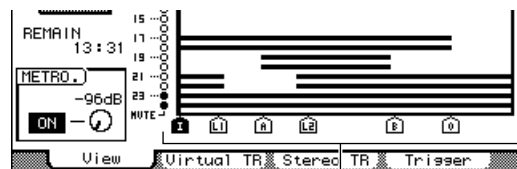

Locator icons

The characters/numbers shown on the display correspond to the locate types are as follows:

Displayed Character/Number	Locate Type
I	In point
O	Out point
A	A point
B	B point
L1-L9	Quick Locator points
S	Start point
E	End point
R	Relative Zero point

**HINT**

- Locate point settings are stored on the hard disk as part of the song.
- Locate points can be adjusted as desired (→ p. 91). Locate points other than the Start point and End point may also be erased (→ p. 93).

## Using markers

“Markers” are symbols that you assign to desired locations in a song so that those points can be quickly located later. You can assign up to 99 markers in each song. Use the MARK SEARCH [◀] / [▶] keys to find and move to markers.

### 1 Move to the position in the song at which you want to assign a marker.

You can assign markers while the song is playing or stopped.

### 2 Press the [MARK] key.

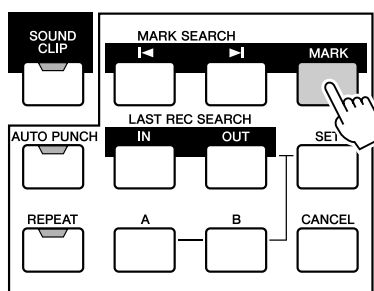

The display will briefly indicate “MARK POINT SET.” This indicates that a marker has been set. A new marker will be added each time you press the [MARK] key. Markers are automatically numbered 1–99 starting at the beginning of the song. If you register a new marker between two existing markers, markers following the insert will be automatically renumbered.

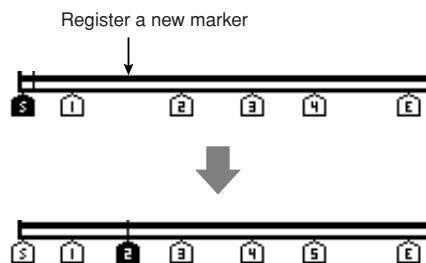

#### HINT

- Marker settings are stored on the hard disk as part of the song.
- Markers can be deleted (→ p. 93) or moved (→ p. 92) as desired.
- If you press the [MARK] key at a location in which a marker has already been registered, the display will indicate “CAN-NOT SET MARK,” and a new marker will not be created.

### 3 Press the [◀] key to locate to the previous marker, or press the [▶] key to locate to the next marker.

The song will move to that location.

Assigned markers will appear as numbers 1–99 in the TRACK screen Track View page.

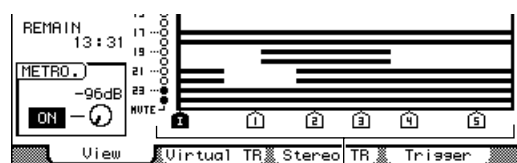

Marker icon

#### HINT

- When creating an audio CD, you can use markers to divide the stereo track into individual tracks that will be written to the audio CD (→ p. 214).

## Adjusting the position of a locate point or marker

Here's how you can adjust the position of a previously-registered locate point or marker. These operations are performed via the EDIT screen Mark Adj. page.

To call this page press the Work Navigate section [EDIT] key as many times as necessary, or press the [F3] key after pressing the [EDIT] key.

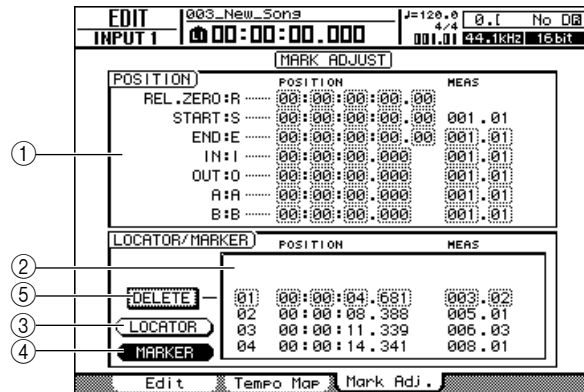

### ① Locator Position field

Shows the various locate points (Quick Locator points not included).

### ② Quick Locator/Marker field

Shows the Quick Locator or Marker points.

### ③ LOCATOR button

These buttons determine whether the Quick Locator or Marker points appear in the Quick Locator/Marker field.

### ⑤ DELETE button (Marker display only)

Deletes the currently selected marker.

## Adjusting the position of a locate point

1 Call the EDIT screen Mark Adj. page by either pressing the Work Navigate section [EDIT] key as many times as necessary, or by pressing the [F3] key after pressing the [EDIT] key.

2 The Locator Position field is used to edit the various locate points (not including the Quick Locator points).

The positions for each locator are displayed in the Locator Position field.

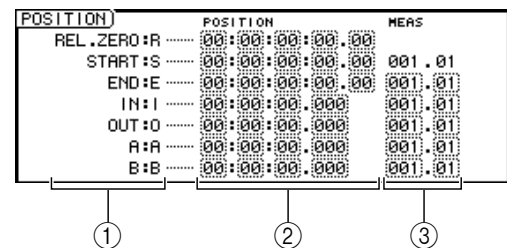

### ① Locate points

Shows the type of locate point and its abbreviation.

### ② Position

Shows the position of each locate point in time code or the current counter display format.

### ③ Measure/beat

Shows the position of each locate point as measures/beats. This value is calculated based on the tempo and time signature of the tempo map (→ p. 175).

The format in which the position is displayed will depend on the locate point. The following table shows the display format for each locate point.

Locate point	Position	Measure/Beat
REL.ZERO	Time code	--
START	Time code	Measure/beat
END	Time code	Measure/beat
IN	Counter display format	Measure/beat
OUT	Counter display format	Measure/beat
A	Counter display format	Measure/beat
B	Counter display format	Measure/beat

### HINT

- If a locate point has not been registered "--" will appear in the numerical field.

**3** Move the cursor to the locate point value that you want to adjust, and use the [DATA/JOG] dial or [INC]/[DEC] keys to change the value.

A “Change START Position?” popup window will ask you for confirmation when you attempt to change the Start point value. Move the cursor to the OK button and press the [ENTER] key, and then change the value.

**NOTE**

- Changing the Start point will cause locations already recorded in a track to move relative to the measure lines defined by the tempo map. Please keep this in mind if you are using measure display for the metronome.

**4** To adjust the location of a quick locator point, move the cursor to the LOCATOR button in the Quick Locator/Marker field and press the [ENTER] key.

When the LOCATOR button is on, the Quick Locator/Marker field will list the quick locate points that have been registered.

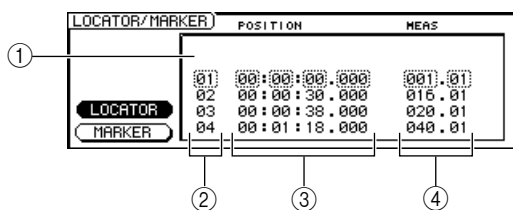

**1 List**

Lists the quick locator points that have been registered. The line that is enclosed by a dotted frame is selected for editing.

**2 Quick locator points**

These are the quick locator point numbers 1–9.

**3 Position**

Shows the position of each quick locator point using the counter display format.

**4 Measure/beat**

Shows the position of each quick locator point in measure/beat units.

**5** Move the cursor to the quick locator point numbers, and use the [DATA/JOG] dial or [INC]/[DEC] keys to scroll through the list so that the dotted frame encloses the quick locator point number that you want to edit.

**6** Move the cursor to the value that you want to edit, and use the [DATA/JOG] dial or [INC]/[DEC] keys to edit the value.

## Adjusting the position of a marker

**1** Call the EDIT screen Mark Adj. page by either pressing the Work Navigate section [EDIT] key as many times as necessary, or by pressing the [F3] key after pressing the [EDIT] key.

**2** If you want to adjust the position of a marker, move the cursor to the MARKER button in the Quick Locator/Marker field.

When the MARKER button is on, the Quick Locator/Marker field will list the markers that have been registered.

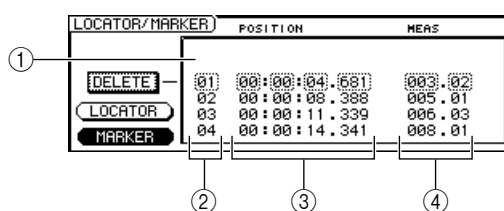

**1 List**

Lists the markers that have been registered. The line that is enclosed by a dotted frame is selected for editing.

**2 Markers**

These are the marker numbers 1–99.

**3 Position**

Shows the position of each marker using the counter display format.

**4 Measure/beat**

Shows the position of each marker in measure/beat units.

**3** Move the cursor to the marker numbers, and use the [DATA/JOG] dial or [INC]/[DEC] keys to scroll through the list so that the dotted frame encloses the marker number that you want to edit.

**4** Move the cursor to the value that you want to edit, and use the [DATA/JOG] dial or [INC]/[DEC] keys to edit the value.

## Erasing a locate point or marker

If necessary, you can erase a registered locate point (except for the Relative Zero, Start, and End points) or marker.



- A locate point that has been erased cannot be recovered.

### Erasing a locate point

To erase a locate point, hold down the Locate section [CANCEL] key and press the corresponding locate key ([IN]/[OUT] key, [A]/[B] key or [LOCATE] key 1–9). The selected locate point will be erased, and the “LOCATE POINT ERASED” message will be displayed briefly.

### Erasing a marker

To erase a marker, locate to the marker that you want to erase, and then press the [MARK] key while holding down the Locate section [CANCEL] key. The corresponding marker will be erased, and the “MARK POINT ERASED” message will be displayed briefly. Markers can also be erased by using the DELETE button in the EDIT screen Mark Adj. page.

## Repeat playback of a specific region (the A-B Repeat function)

The AW2400 provides an “A-B Repeat” function that repeatedly plays the region between the A point and B point. This is useful when you want to repeatedly play back a certain region of the song while adjusting the mix.

### 1 Register the A point and B point at the locations at which you want to start and end repeat playback.

For details on how to set the A point and B point, refer to “Using the locator” (→ p. 88).



- If you set the B point earlier than the A point, the B → A region will play repeatedly.

### 2 Press the [REPEAT] key while the transport is stopped.

The [REPEAT] key will light and the A-B Repeat function will be engaged. The song will automatically locate to the A point.



- The A and B points must be at least one second apart. If they are closer than one second a “REPEAT POINTS TOO CLOSE” message will appear when you press the [REPEAT] key and repeat playback will not be possible.

### 3 Press the PLAY [▶] key to begin repeat playback.

Playback will begin from the A point. When the B point is reached playback will automatically begin again from the A point.



- Playback will stop automatically when the A/B region has been repeated 99 times.
- If you press the [REPEAT] key while the song is playing, repeat playback between the A and B points will begin automatically, regardless of the current position.

### 4 To stop playback, press the STOP [■] key.

Playback will stop, but the A-B Repeat function will remain active. When the A-B Repeat function is on, pressing the PLAY [▶] key will immediately resume repeat playback regardless of the current position.

### 5 Press the [REPEAT] key to cancel repeat playback.

The [REPEAT] key indicator will go out and the A-B Repeat function will be cancelled. If you cancel the A-B Repeat function during repeat playback, normal playback will continue from that point.



- If you perform a record operation while the A-B Repeat function is engaged, the A-B Repeat function will be temporarily disabled.

## Finding a location while monitoring the sound (the Nudge function)

“Nudge” is a function that repeatedly plays a short region before or after the current location. By using the Nudge function, you can find a precise location while listening to playback. This is useful when you need to specify a location precisely, such as when specifying auto punch-in/out points, or when editing the contents of a track.

**1** Locate to the vicinity of the point you want to find.

**2** Press the [JOG ON] key while the transport is stopped.

The [JOG ON] key will light, and the Nudge function will be engaged. A fixed region (referred to as the “nudge time”) starting at the current location will play repeatedly.

**3** To move the current location forward, turn the [DATA/JOG] dial to the right. To move the current location backward, turn the [DATA/JOG] dial to the left.

If time display is selected as the counter display format, you can move the current location forward or backward in millisecond units. If time code display is selected, you can move in sub-frame units.

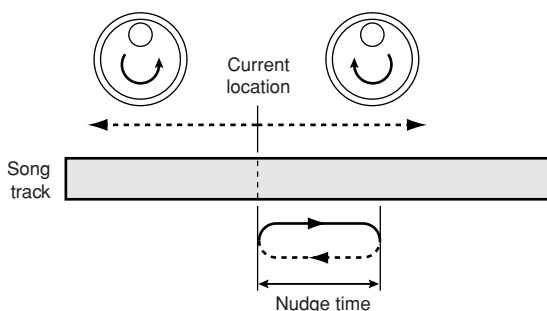

### HINT

- You can use locate points or markers to change the location, or register locate points or markers while using the Nudge function.
- The nudge direction and time can be adjusted as required. Refer to “AW2400 Preferences” on page 210 for details.

**4** To turn off the Nudge function, press the [JOG ON] key or the transport section STOP [■] key.

The [JOG ON] key indicator will go out, and the Nudge function will be cancelled.

## Finding a location while viewing the waveform

The AW2400 lets you find a location while viewing the waveform of the sound recorded on a track.

- 1 **Locate to the vicinity of the point you want to find.**
- 2 **Call the TRACK screen Track View page by either pressing the Work Navigate section [TRACK] key as many times as necessary, or by pressing the [F1] key after pressing the [TRACK] key.**

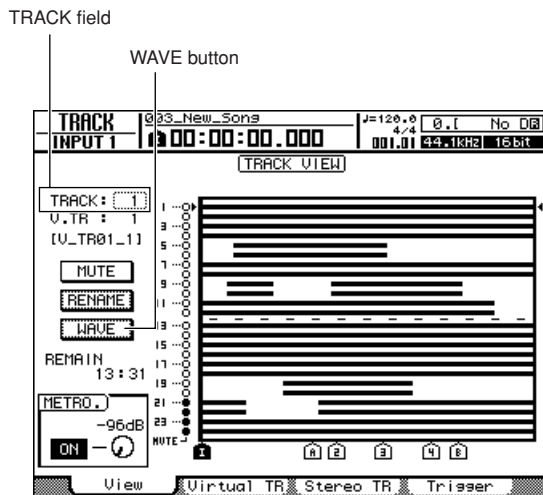

- 3 **Move the cursor to the TRACK field, and use the [DATA/JOG] dial or [INC]/[DEC] keys to select the number of the track corresponding to waveform you want to view.**
- 4 **Move the cursor to the WAVE button and press the [ENTER] key.**

The WAVE DISPLAY popup window will appear. This popup window displays the waveform of the audio data recorded in the track selected in step 3 (1-24 or ST-L/R).

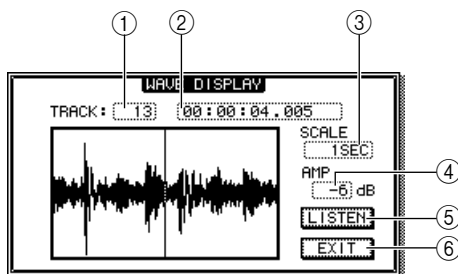

### ① TRACK

Indicates the currently selected track number. You can also move the cursor to this field and use the [DATA/JOG] dial or [INC]/[DEC] keys to switch tracks.

### ② Counter

Displays the location of the vertical line (pointer) indicating the current location in the WAVE DISPLAY popup window. You can move the cursor to this field and use the [DATA/JOG] dial or [INC]/[DEC] keys to move the current location forward or backward.

### ③ SCALE

By moving the cursor to this area and using the [DATA/JOG] dial or [INC]/[DEC] keys you can expand or shrink the waveform display along the time axis. The value of this field indicates the length of time displayed in the WAVE DISPLAY popup window.

If you select 1SEC, the distance from the left to right edge of the screen will correspond to one second. Selecting SAMPLE will produce the highest magnification, and each horizontal pixel will correspond to one sample.

### ④ AMP

By moving the cursor to this area and using the [DATA/JOG] dial or [INC]/[DEC] keys you can expand or shrink the waveform display along the amplitude axis. The value of this field indicates the level range of the waveform displayed in the WAVE DISPLAY popup window. If you select 0 dB, the top and bottom edges of the screen will correspond to the maximum level.

### ⑤ LISTEN button

If you move the cursor to this button and press the [ENTER] key the waveform in the display area of the WAVE DISPLAY popup window will be played once. During playback the vertical line (pointer) that indicates the current location will move, and the counter value will change accordingly.

Normal transport operation is disabled while using the LISTEN button.

### ⑥ EXIT button

Move the cursor to this button and press the [ENTER] key to exit the WAVE DISPLAY popup window and return to the previous Track View page.

#### HINT

- The WAVE DISPLAY popup window cannot be displayed while the recorder is running.
- You can use the Mixer section [SEL] or [STEREO SEL] keys to switch the track being viewed even after displaying the WAVE DISPLAY popup window.

**5** Move the cursor to the **SCALE/AMP** fields and use the **[DATA/JOG]** dial or **[INC]/[DEC]** keys to adjust the vertical and horizontal scale of the waveform display as required.

**6** To specify a location within the popup window, move the cursor to the counter and turn the **[DATA/JOG]** dial.

Turning the dial to the right will move the pointer forward, and turning the dial to the left will move it backward. If necessary, you can use the **LISTEN** button to play the waveform region shown in the **WAVE DISPLAY** popup window, and check the location by listening.



- The locators and markers within a song can also be used to position the pointer (→ p. 88, 90).
- The current counter location can be saved to a locator or marker (→ p. 88, 90).

**7** When you have finished specifying the location, move the cursor to the **EXIT** button and press the **[ENTER]** key.

You will return to the previous Track View page, and the location that you specified in the popup window will remain the current location. Register the location as a locate point or marker as required.



# ◆ Chapter 10 ◆

## Meters

This section describes how the level meters can be shown on the display screen, and how they can be used to check levels of various signals through the system.

### Level Meter Types

Four display pages accessible via the METER screen are used to access the various level meter displays. Press the [METER] key to call the METER screen, and then either press the [METER] key as many times as necessary until the desired page appears, or press the function key ([F1]–[F4]) corresponding to the desired page.

The contents of the various METER displays are as follows:

#### ■ METER screen Input/RTN page ([F1] key)

#### ■ METER screen Track page ([F2] key)

##### ● Input/RTN Page

Displays the input and fader levels for input channels 1–16 as well as effect return channels 1–4.

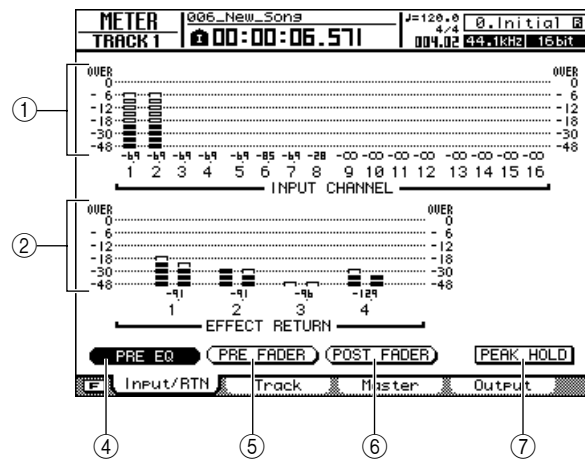

##### ● Track Page

Displays the input and fader levels for track channels 1–24.

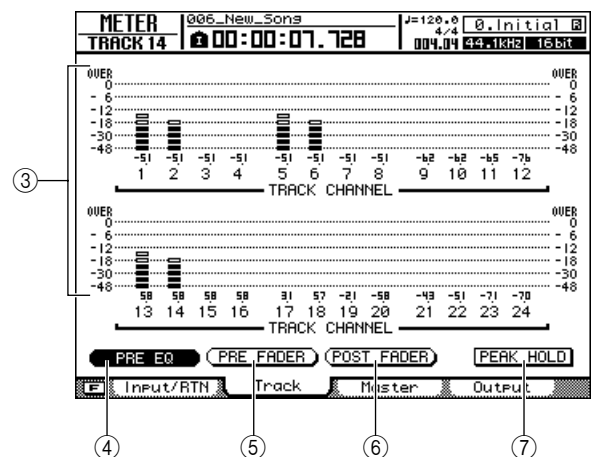

The following items are displayed:

- ① Input channel 1–16 input levels
- ② Effect return channel 1–4 input levels
- ③ Track channel 1–24 input levels

The level meters display the input levels for the corresponding channels, while the numbers below the level meters show the fader levels in dB.

##### ④ PRE EQ button

Pre-EQ levels (levels prior to the EQ stage) are displayed when this button is on.

##### ⑤ PRE FADER button

Pre-fader levels (levels prior to the faders) are displayed when this button is on.

##### ⑥ POST FADER button

Post-fader levels (levels after the faders) are displayed when this button is on.

⑦ **PEAK HOLD button**

This button switches the level meter peak hold function on/off. When this button is on, an indicator will show the signal peaks.



- The Input/RTN page and Track page PRE EQ/PRE FADER/POST FADER button settings are linked, while the Master page settings are independent.
- The PEAK HOLD button setting affects all METER pages.
- Pressing the [F1] key while holding the Display section [SHIFT] key has the same effect as the PEAK HOLD button.

■ **METER screen Master page ([F3] key)**

Displays the output and fader levels for BUS1 L/R, BUS2 L/R, AUX bus 1–4, effect bus 1–4, and the stereo bus.

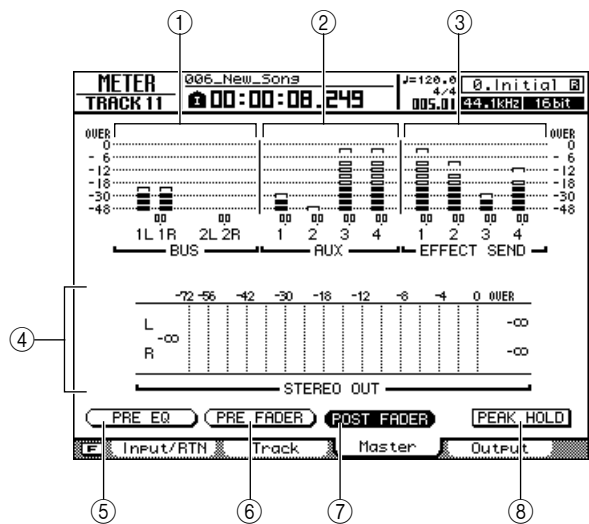

The following items are displayed:

- ① **BUS1 L/R, BUS2 L/R output levels**
- ② **AUX bus 1–4 output levels**
- ③ **Effect bus 1–4 output levels**
- ④ **Stereo bus output level**

The level meters display the output levels for the corresponding channels, while the numbers below the level meters show the fader levels in dB.

⑤ **PRE EQ button**

Pre-EQ levels (levels prior to the EQ stage) are displayed when this button is on.

⑥ **PRE FADER button**

Pre-fader levels (levels prior to the faders) are displayed when this button is on.

⑦ **POST FADER button**

Post-fader levels (levels after the faders) are displayed when this button is on.

⑧ **PEAK HOLD button**

This button switches the level meter peak hold function on/off.



- These PRE EQ/PRE FADER/POST FADER settings are independent from those on other pages.
- The PEAK HOLD button setting affects all METER pages.
- Pressing the [F1] key while holding the Display section [SHIFT] key has the same effect as the PEAK HOLD button.

■ **METER screen Output page ([F4] key)**

Displays the output and fader levels for a digital I/O card installed in the card slot, the [OMNI OUT] 1–4 outputs, and the [DIGITAL STEREO OUT] outputs.

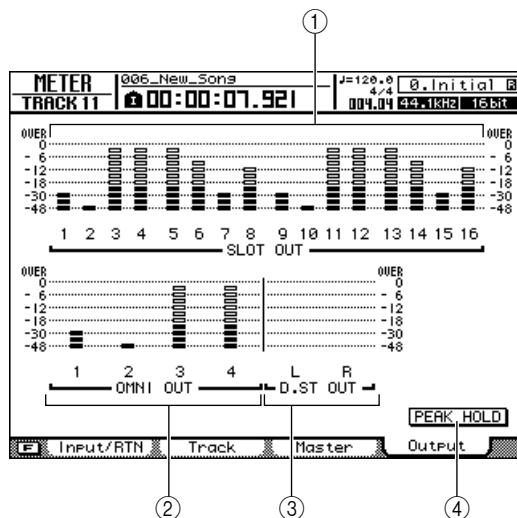

The following items are displayed:

- ① **Output levels for the card installed in the slot**
- ② **[OMNI OUT] 1–4 output levels**
- ③ **[DIGITAL STEREO OUT] output levels**

The level meters display the output levels for the corresponding channels, while the numbers below the level meters show the fader levels in dB.

④ **PEAK HOLD button**

This button switches the level meter peak hold function on/off.



- The PEAK HOLD button setting affects all METER pages.
- Pressing the [F1] key while holding the Display section [SHIFT] key has the same effect as the PEAK HOLD button.

# Patching and signal flow

This chapter explains patching and channel signal flow.

## Input signal patching

To record a mic or instrument connected to the AW2400, you can use either of two recording methods; Direct Recording or Mixed Recording. The patching method will depend on the recording method you use.

### Direct Recording

With this method only one input channel is assigned to each recorder track. Although direct recording requires the same number of tracks as the number of input channels you use, it has the advantage that you will be free to adjust the volume, pan (stereo position), and EQ of each track after it has been recorded.

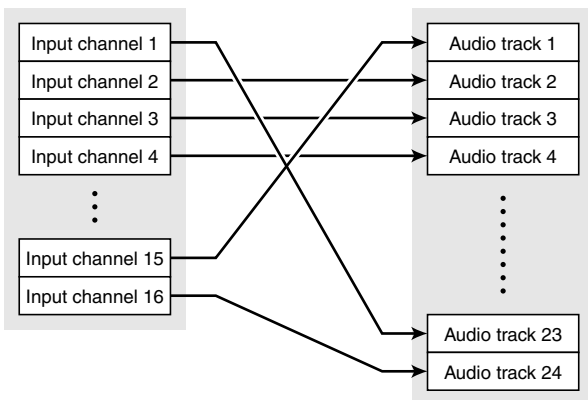

### Mixed Recording

With this method, you can send multiple input channels to Bus 1 or Bus 2, and assign the mixed signal to one through four tracks. Mixed recording requires fewer tracks, but you will need to decide on the final volume, pan, and tone of each instrument at the time of recording (you will not be able to adjust these parameters independently after recording.)

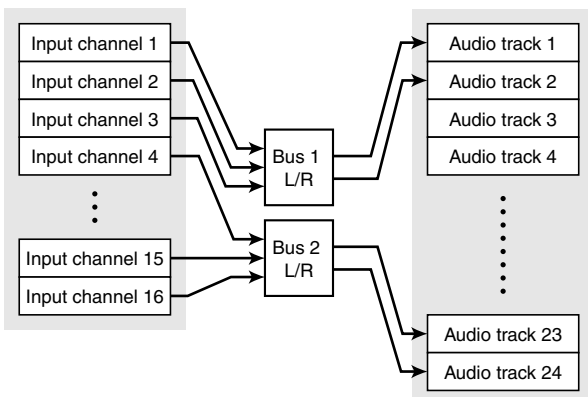

### Patching for Direct Recording

This section explains how to patch the signals of input channels to tracks when you're using the Direct Recording method.

- 1 Call the RECORD screen Direct page by either pressing the Quick Navigate section [RECORD] key as many times as necessary, or by pressing the [F1] key after pressing the [RECORD] key.

This page contains the following items.

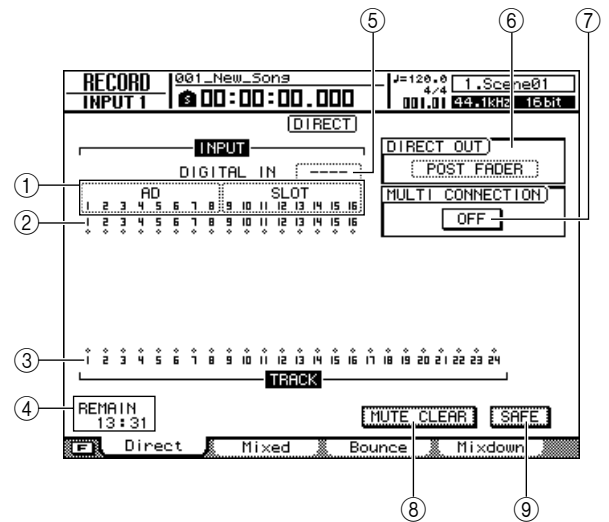

#### 1 Input Select

Here you can select the inputs (input signals) that will be patched to input channels 1–8 or 9–16. You can choose from the following inputs.

- AD 1–8 ..... Analog input signals from [MIC/LINE INPUT] jacks 1–8
- SLOT 1–8 ..... Input signals from inputs 1–8 of an I/O card installed in the slot
- SLOT 9–16 ..... Input signals from inputs 9–16 of an I/O card installed in the slot
- ---- ..... Not selected

② **Input channels**

This area indicates the connection state of input channels 1–16. When you move the cursor to the ◊ symbol and press the [ENTER] key, the symbol will be highlighted and the corresponding input channel will be selected as a recording source.

③ **Tracks**

This area indicates the connection state of tracks 1–24. When you move the cursor to the ◊ symbol and press the [ENTER] key, the symbol will be highlighted and the corresponding track will be selected as a recording destination. You can switch a track's mute status on/off by moving the cursor to the number that indicates the track number and pressing the [ENTER] key.

④ **REMAIN**

This indicates the remaining recordable time. The remaining time will depend on the number of tracks that are enabled for recording.

⑤ **DIGITAL IN**

This assigns the [DIGITAL STEREO IN] connector to an input channel. Here you can select from the following items.

- **1.2–15.16** .....Assign the signal of the [DIGITAL STEREO IN] connector to a pair of adjacent odd-numbered/even-numbered input channels (1/2–15/16).
- **---** .....The [DIGITAL STEREO IN] connector will not be used.

The DIGITAL IN setting takes priority over other inputs selected in the Input Select area. When you assign the DIGITAL IN to an input channel, the corresponding input number in the Input Select area will change to a ◆ symbol. This indicates that a signal has already been assigned to the corresponding input channel.

**NOTE**

- If you enable cascade connection, the digital audio signal received from the [DIGITAL STEREO IN] connector will be sent directly to the stereo bus. While this state exists, the DIGITAL IN field will indicate "ST BUS," and cannot be changed until you disable cascade connection.

⑥ **DIRECT OUT**

Here you can select the send position from which the signal of an input channel or track channel is sent to direct output.

- **PRE FADER**.....The pre-fader signal
- **POST FADER**.....The post-fader signal

⑦ **MULTI CONNECTION ON/OFF button**

If this button is on, you can connect a set of eight input channels and eight tracks in a single operation.

⑧ **MUTE CLEAR button**

This button clears the mute status of all tracks. However depending on the bit depth of the song and on the number of tracks that are enabled for recording, there may be cases in which some tracks cannot be unmuted. If so, tracks will be muted consecutively starting with the last-numbered track.

⑨ **SAFE button**

When you move the cursor to this button and press the [ENTER] key, all input channel and track channel assignments will be cancelled. This will also execute the MUTE CLEAR (⑧) operation.



- Pressing the [F1] key while holding the Display section [SHIFT] key has the same effect as the SAFE button.

**2 Move the cursor to the Input Select field, and use the [DATA/JOG] dial or the [INC]/[DEC] keys to select the input that will be patched to each input channel.**

For example if you want mics/instruments connected to [MIC/LINE INPUT] jacks 1–8 to be patched to input channels 1–8, you would make settings as shown below.

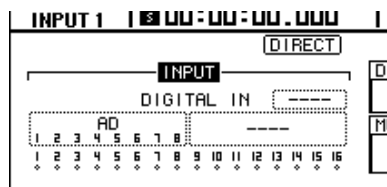

**3 Move the cursor to the ◊ symbol for the record-source input channel, and press the [ENTER] key.**

The symbol will be highlighted, and the corresponding input channel will be selected as a recording source. The corresponding [INPUT SEL] key (or the [SEL] key of the corresponding input channel) will light red, and the remaining [INPUT SEL] keys (or the [SEL] keys of the remaining input channels) will go dark.

If the selected input channel is not yet assigned to a track, all [SEL] keys for the track channels will blink red, indicating that they can be selected as the recording destination.

If the selected input channel has already been assigned to a track, only the [SEL] key of the corresponding track channel will blink red.

For example if you selected input channel 1 as the recording source, the top panel keys will be as follows.

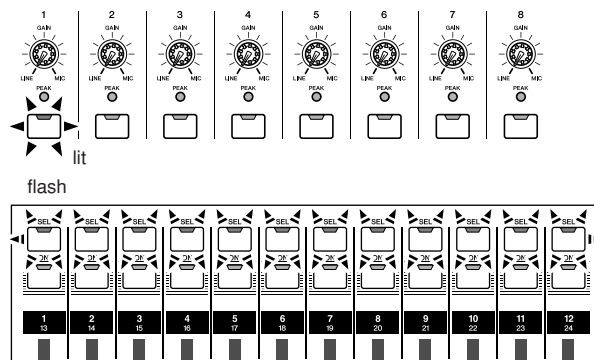

Track channels  
(Layer section [TRACK 1-12] key lit)

The indication in the screen will be as follows.



- You can also select the record-source input channel by pressing an [INPUT SEL] key (or the [SEL] key of an input channel).
- The [INPUT SEL] keys always control input channels 1–8, regardless of the settings of the Layer section



#### 4 Move the cursor to the symbol for the recording-destination track, and press the [ENTER] key.

The selected input channel and track will be internally connected.

At this time, the connected [INPUT SEL] key (or the input channel's [SEL] key) and the track channel's [SEL] key will change to blinking red.

The blinking track channel [SEL] key indicates that the corresponding track is in record-ready mode.

For example if input channel 1 and track 1 are connected, the top panel keys will be as follows.

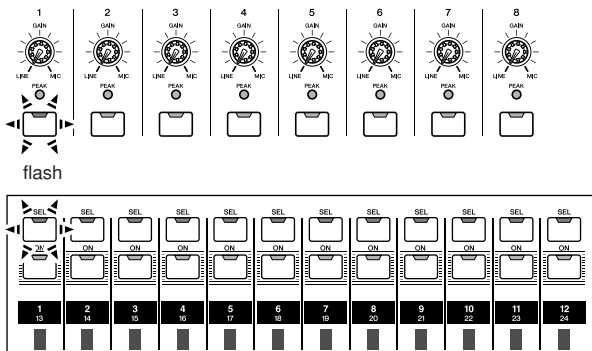

Track channels (Layer section [TRACK 1-12] key lit)

The indication in the screen will be as follows.



- You can also select the record-destination track by pressing a track channel's [SEL] key.
- The same internal connection will be established even if you perform steps 3 and 4 in the reverse order.
- The fader will automatically be set to 0 dB for input channels that are internally connected to a track.
- If an input channel is selected as a recording-source, its assignment to the stereo bus will automatically be turned off. If you want to monitor the signal you're recording, you'll need to raise the fader of the recording-destination track channel.
- EQ and dynamics settings will be set to a flat state for track channels corresponding to tracks selected as recording-destinations.



**NOTE**

- Input channels and tracks are always connected one-to-one.
- The track numbers of muted tracks will be displayed as (mute), but you can still record to muted tracks.
- Since 24-bit songs can have a maximum of 12 play tracks (→ p. 165), tracks 13–24 are muted and will not play back.

#### 5 If you want to record multiple instruments or mics simultaneously, assign other input channels to other tracks in the same way.



- To cancel a connection you established, simply repeat the same operation you did when establishing the connection.
- To change a recording-destination (track) that you've already connected, move the cursor to the recording-source and press the [ENTER] key; then move the cursor to a different track and press the [ENTER] key.
- To change a recording-source (input channel) that you've already connected, move the cursor to the recording-destination and press the [ENTER] key; then move the cursor to a different input channel and press the [ENTER] key.
- To cancel all connections, move the cursor to the SAFE button and press the [ENTER] key.
- If a recording-source input channel and the recording-destination track are both paired, two adjacent odd-numbered/even-numbered channels will be assigned to two adjacent odd-numbered/even-numbered tracks.

#### 6 If you want to connect a set of eight input channels and eight tracks in a single operation, turn the MULTI CONNECTION ON/OFF button on.

For example if the MULTI CONNECTION ON/OFF button is on, and you select any one of input channels 1–8 as a recording-source and any one of tracks 1–8 as a recording-destination, the following popup window will appear.

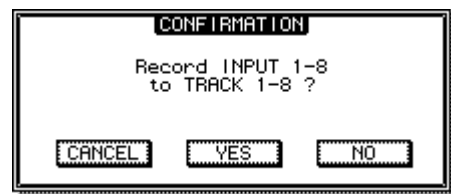

Move the cursor to the YES button and press the [ENTER] key to execute the connection; input channels 1–8 will be connected to tracks 1–8. Move the cursor to the NO button and press the [ENTER] key to connect the selected input channel and track.

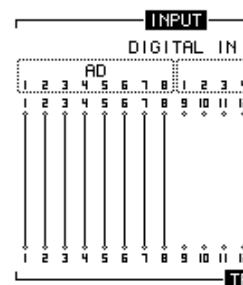

Similarly if you specify input channels 9–16 as the recording-source, input channels 9–16 will be connected to tracks 1–8. If you specify any one of tracks 9–16 (or 17–24) as the recording destination, the specified input channels will be connected to tracks 9–16 (or 17–24).

## Patching for Mixed Recording

This section explains patching when you're using the Mixed Recording method.

- 1 Call the RECORD screen Mixed page by either pressing the Quick Navigate section [RECORD] key as many times as necessary, or by pressing the [F2] key after pressing the [RECORD] key.

The RECORD screen Mixed page lets you send the signals of the input channels via two stereo buses (bus 1 and bus 2) to one to four tracks you specify.

This page contains the following items.

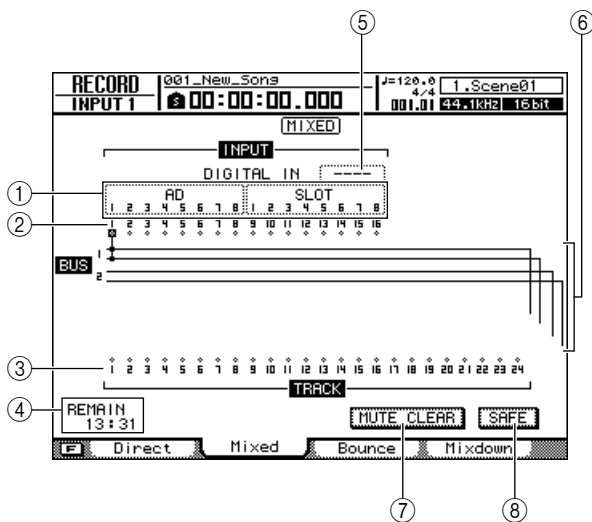

### 1 Input Select

Here you can select the inputs that will be patched to input channels 1–8 or 9–16. You can choose from the same inputs as in the RECORD screen Direct page.

### 2 Input channels

This area indicates the connection status of input channels 1–16.

### 3 Tracks

This area indicates the connection status of tracks 1–24.

You can switch track muting on/off by moving the cursor to the track number and pressing the [ENTER] key.

### 4 REMAIN

This indicates the remaining recordable time.

### 5 DIGITAL IN

Here you can assign the [DIGITAL STEREO IN] connector to an input channel. The available choices and operations are the same as in the RECORD screen Direct page.

### 6 Bus 1, Bus 2

These four lines indicate the bus 1 L/R and bus 2 L/R signal routes. This shows the recording-source input channels whose signals are being sent to bus 1/bus 2, and the recording-destination tracks to which the bus 1/bus 2 signal are being sent.

### 7 MUTE CLEAR button

This button clears the mute status of all tracks.

However depending on the bit depth of the song and on the number of tracks that are enabled for recording, there may be cases in which some tracks cannot be unmuted. If so, tracks will be muted consecutively starting with the last-numbered track.

### 8 SAFE button

When you move the cursor to this button and press the [ENTER] key, all input channel and track channel assignments will be cancelled. This will also execute the MUTE CLEAR (7) operation.



- Pressing the [F1] key while holding the Display section [SHIFT] key has the same effect as the SAFE button.

- 2 Move the cursor to the Input Select area, and use the [DATA/JOG] dial or the [INC]/[DEC] keys to select an input that you want to patch to an input channel.

- 3 Move the cursor to the  $\diamond$  symbol for the desired recording-source input channel, and press the [ENTER] key.

The symbol will be highlighted, and the corresponding input channel will be connected to bus 1.

- 4 Press the [ENTER] key repeatedly at the same cursor location as in step 3 to select the send-destination for the signal of that input channel.

Each time you press the [ENTER] key, the screen will change as follows.

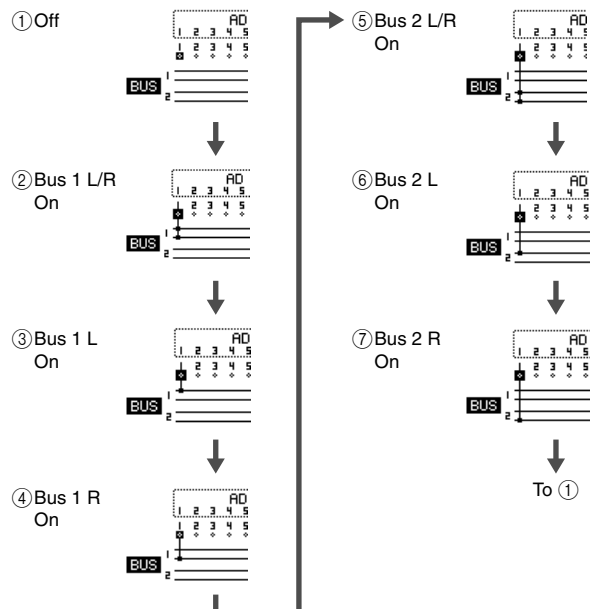

## HINT

- You can also perform steps 3–4 by repeatedly pressing the [INPUT SEL] key (or the input channel's [SEL] key).
- The [INPUT SEL] keys always control input channels 1–8, regardless of the settings of the Layer section.
- If an input channel is selected as a recording-source, its assignment to the stereo bus will automatically be turned off, and it will be connected via bus 1 or bus 2 so that it can be monitored by the track channel.

## 5 In the same way, select other input channels as recording-sources.

## 6 Move the cursor to the $\diamond$ symbol for the desired recording-destination track, and press the [ENTER] key.

A popup window will appear, asking you to confirm whether you want to initialize the channel parameters.



## 7 Move the cursor to the OK button and press the [ENTER] key.

You can select up to four tracks as recording-destinations. Bus 1L/bus 2L can be connected to odd-numbered tracks, and bus 1R/bus 2R can be connected to even-numbered tracks. The [SEL] key of the connected track channels will blink red, indicating that they are in record-ready mode.

You can select the bus signal to be input by repeatedly pressing the [ENTER] key in the same way as for the input channels.

For example if you move the cursor to the  $\diamond$  symbol for track 1 and repeatedly press the [ENTER] key, the screen will change as follows.

## ① Connected to Bus 1 L

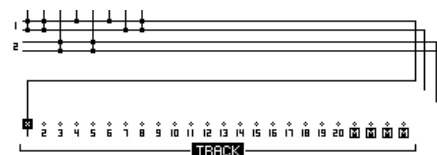

## ② Connected to Bus 2 L

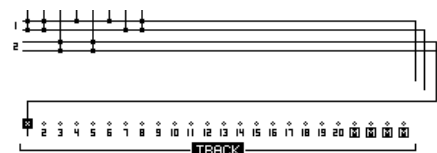

## ③ No Connection

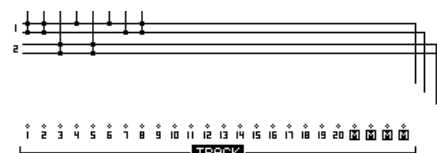

To ①

## HINT

- You can also perform this operation by repeatedly pressing the track channel's [SEL] key.
- EQ and dynamics setting will be set to a flat state for track channels corresponding to tracks that are selected as a record destination.
- When a single track is selected as the record destination the pan of the corresponding track channel will automatically be set to center. When paired tracks are selected as the record destination the pan settings of the odd- and even-numbered tracks will automatically be set to left and right, respectively.
- To cancel all connections, move the cursor to the SAFE button and press the [ENTER] key.

## NOTE

- The track numbers of muted tracks will be displayed as  $\blacksquare$  (mute), but you can still record to muted tracks.
- Since 24-bit songs can have a maximum of 12 play tracks (→ p. 165), tracks 13–24 are muted and will not play back.

## 8 Proceed with recording.

For details on recording, refer to “Track recording” (→ p. 47).

# Output signal patching

The PATCH screen Output page lets you select the signals that are assigned to the AW2400's [OMNI OUT] jacks, [DIGITAL STEREO OUT] connector, and the output channels of an I/O card installed in the I/O slot.

To call this page press the Work Navigate section [PATCH] key.

This page contains the following items.

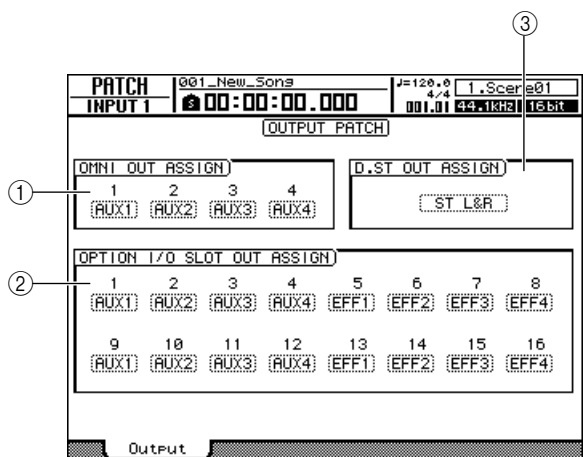

### ① OMNI OUT ASSIGN field

Move the cursor to fields 1–4 and use the [DATA/JOG] dial or the [INC]/[DEC] keys to select the signal that will be assigned to each [OMNI OUT] jack. Press the [ENTER] key to finalize your selection.

You have the following choices.

Display	Type of signal
---	No assignment
ST L/ST R	Stereo output channel L/R
AUX 1–4	AUX send master 1–4
EFF 1–4	Effect send master 1–4
TR 1–24	Track channel direct outputs 1–24

### ② OPTION I/O SLOT OUT ASSIGN field

Move the cursor to fields 1–16 and use the [DATA/JOG] dial or the [INC]/[DEC] keys to select the signal that will be assigned to each output channel of a digital I/O card installed in the I/O slot. Press the [ENTER] key to finalize your selection.

You have the following choices.

Display	Type of signal
---	No assignment
ST L/ST R	Stereo output channel L/R
AUX 1–4	AUX send master 1–4
EFF 1–4	Effect send master 1–4
TR 1–24	Track channel direct outputs 1–24
INS <sup>*1</sup>	Insert send

\*1. "INS" will appear only if SLOT1–SLOT16 is selected for INSERT EFF in the CH VIEW screen View page. If you attempt to change "INS" to a different item in the PATCH screen Output page, a popup message ("Used As Effect Insert!") will appear, and you won't be able to execute the change. In order to change this, you will first have to defeat the selection for the corresponding output channel in the CH VIEW screen View page.

### ③ D.ST OUT ASSIGN field

Move the cursor to this field and use the [DATA/JOG] dial or the [INC]/[DEC] keys to select the signal that will be assigned to the [DIGITAL STEREO OUT] connector.

Press the [ENTER] key to finalize your selection.

You have the following choices.

Display	Type of signal
---	No assignment
ST L&R	Stereo output channel L&R
AUX 1&2, 3&4	AUX send master 1&2, 3&4
EFF 1&2, 3&4	Effect send master 1&2, 3&4
TR 1&2–23&24	Track channel direct outputs 1&2–23&24

#### HINT

- The signal of the stereo bus is always assigned to the [STEREO OUT] jacks.



# ◆ Chapter 12 ◆

## Channel Operation

This chapter describes procedures for displaying and operating the parameters for individual channels as well as for saving and recalling data library settings for individual settings.

### Displaying the mix parameters for individual channels

If you access the CH VIEW screen View page, you can not only see the signal flow for the selected channel, but also adjust the mix parameters within the displayed signal path.

To call this page press the Selected Channel section [VIEW] key as many times as necessary, or press the [F1] key after pressing the [VIEW] key.

Immediately after pressing the [VIEW] key the signal flow of the currently selected channel will appear on the display. You can select any other channel to be displayed by using the Layer section keys to select a mixing layer, and the [INPUT SEL], [SEL], and [STEREO SEL] keys to select individual channels.

The items included in the individual channel displays are as follows.

#### Input channels 1-16

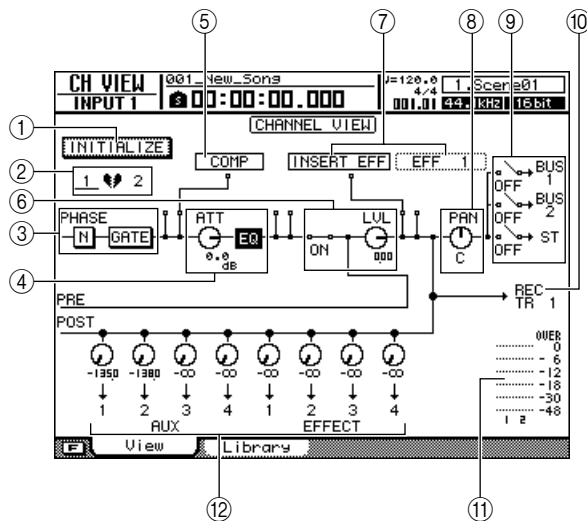

#### Track channels 1-24

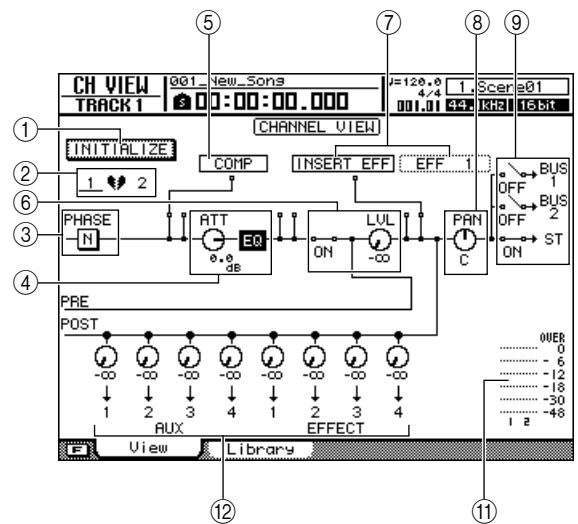

#### Effect return channels 1-4

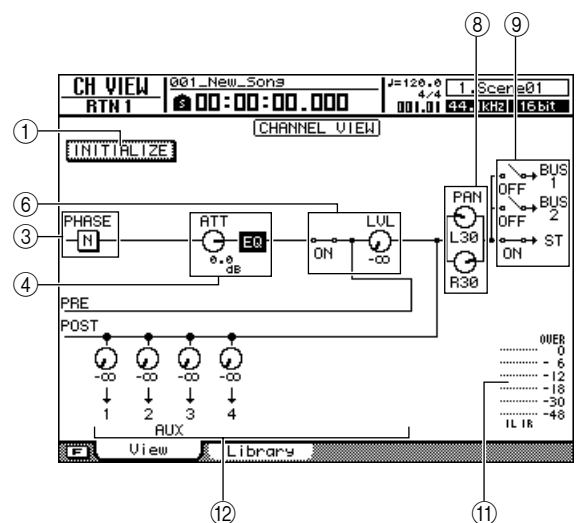

## ■ Stereo output channel

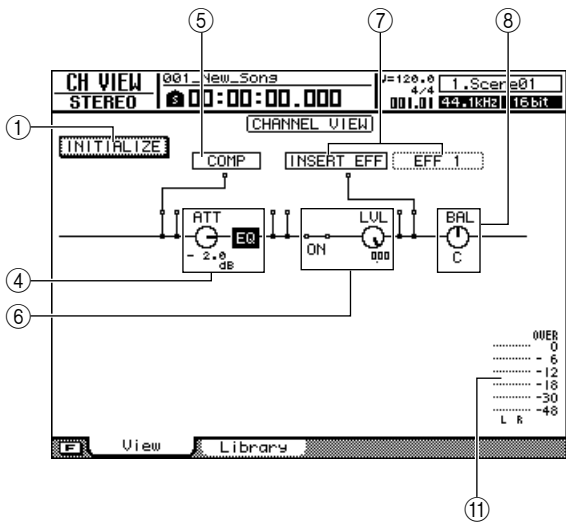

## ■ Effect send master channels 1-4

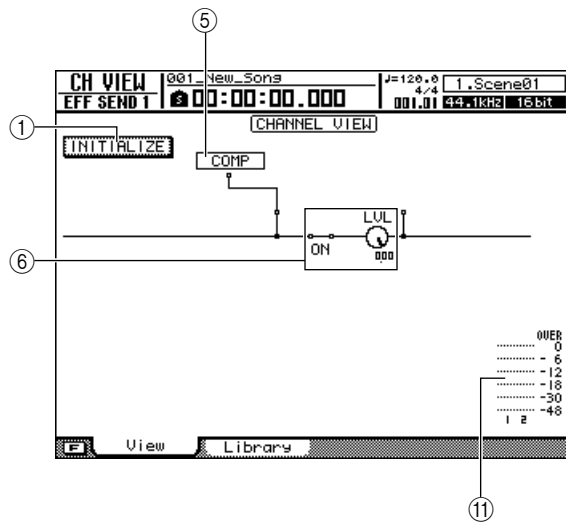

## ■ Bus master channels 1, 2

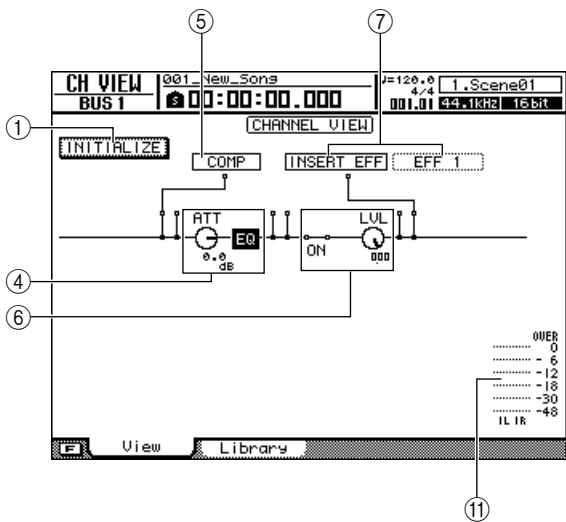

### ① INITIALIZE button

Initializes all parameters for the currently displayed channel.



• Pressing the [F1] key while holding the Display section [SHIFT] key has the same effect as the INITIALIZE button.

### ② Channel Pair Indicator

Indicates whether the displayed channel is part of a pair or not. You can also move the cursor to this indicator and press the [ENTER] key to turn pairing on or off.

### ③ PHASE button, GATE button

- **PHASE button** ..... Switches the phase (polarity) of the input signal. Move the cursor to this button and press the [ENTER] key to switch between normal (N : NORMAL) and reverse (R : REVERSE) polarity.

- **GATE button (input channels only)**

..... Move the cursor to this button and press the [ENTER] key to turn the gate for that channel on or off. Refer to "Using the Gates" on page 151 for details.

### ④ ATT button, EQ button

- **ATT button** ..... Move the cursor to this knob and use the [DATA/JOG] dial or [INC]/[DEC] keys to adjust the attenuation as required (range: -96—+12dB). This capability can be used to attenuate the pre-EQ signal level to prevent clipping in the EQ stage.

- **EQ button** ..... Move the cursor to this button and press the [ENTER] key to turn the EQ for that channel on or off. Refer to "4-band EQ" on page 149 for details.

## ■ AUX send master channels 1-4

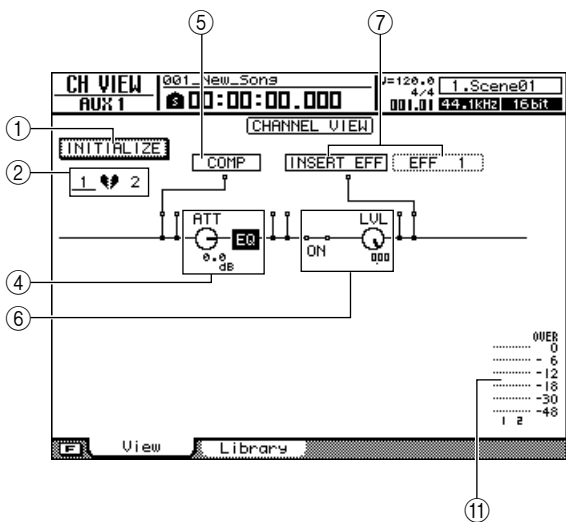

⑤ **COMP**

Move the cursor to the  symbol below COMP and press the [ENTER] key to turn the compressor for that channel on or off or select the compressor insert point.

Press the [ENTER] key repeatedly to sequentially select the following insert points.

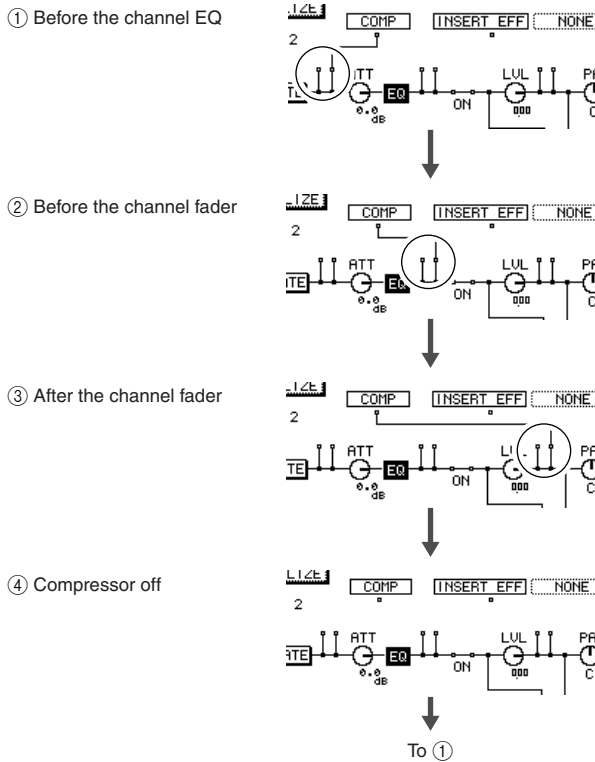

Refer to “Using the Compressors” on page 152 for details.

**HINT**

- You can move the cursor to the insert point and press the [ENTER] key to reverse the order of the COMP and an INSERT EFF.

**NOTE**

- Since no EQ is provided on the effect send master channels, the compressor can be inserted either pre-fader or post-fader.

⑥ **ON/OFF, LVL knob**

- ON/OFF** ..... Move the cursor to this position and press the [ENTER] key to turn the channel on or off. This function is linked to the channel [ON] keys.
- LVL knob** ..... Move the cursor to this knob and use the [DATA/JOG] dial or [INC]/[DEC] keys to adjust the channel level. This function is linked to the channel faders.

⑦ **INSERT EFF**

This parameter is used to insert an internal effect to a specified point in the channel, or to specify an insert point for insertion of an external effect.

If you move the cursor to the field to the right of INSERT EFF and press the [ENTER] key, a popup window will appear allowing selection of an internal effect or I/O channel on an optional I/O card.

**HINT**

- For details on insert effect operation refer to “Inserting an Effect Into a Channel” on page 119.
- When SLOT1–16 is selected the specified channel insert point is assigned to the corresponding channel on an optional I/O card installed in the AW2400. This assignment is shown in the PATCH screen Output page OPTION I/O SLOT OUT ASSIGN field.
- You can move the cursor to the insert point and press the [ENTER] key to reverse the order of the COMP and an INSERT EFF.

⑧ **PAN/BAL knob**

Move the cursor to this knob and use the [DATA/JOG] dial or [INC]/[DEC] keys to pan the channel signal to the stereo bus or bus 1 and bus 2 (for stereo input channels this functions as a balance control). The effect return channel L and R signals can be adjusted individually. These knobs are linked to the PAN/EQ screen knobs (→ p. 147).

⑨ **BUS1, BUS2, ST**

Move the cursor to any of these points and press the [ENTER] key to turn assignment of the channel signal to the corresponding bus – bus 1, bus 2, or stereo bus – on or off.

⑩ **REC TR**

Displays the input channel to track assignment, as specified in the RECORD screen Direct page.

⑪ **Level meter**

The level meters display input channel, track channel and effect return channel input levels, as well as stereo output channel, bus master channel, AUX send master channel, effect send master channel output levels.

⑫ **AUX, EFFECT**

Move the cursor to the appropriate knob and use the [DATA/JOG] dial or [INC]/[DEC] keys to adjust send levels to AUX bus 1–4 or effect bus 1–4 over a range of from  $-\infty$  to +10dB. You can also move the cursor to one of these knobs and press the [ENTER] key to turn the corresponding send off. Further, if you move the cursor to the signal path above the knob and press the [ENTER] key you can switch between pre-fader (PRE) and post-fader (POST) send.

These functions are linked to the AUX and EFFECT screens (→ p. 111, 115).

**NOTE**

- Signals cannot be sent to the effect buses from an effect return channel.

# Channel Library Operation

The mix parameters for individual channels can be saved to and recalled from dedicated libraries as required. This is particularly handy when you want to use the settings made for one channel in one or more other channels as well. Library numbers 0–1 contain read-only data for channel initialization, while numbers 2–64 can be used save and recall your own data. The following parameters can be saved to the channel library.

- Channel on/off
- Channel attenuator
- EQ on/off
- EQ parameter settings
- Dynamics processor on/off
- Dynamics processor parameter settings
- Fader position
- AUX bus 1–4 pre-fader/post-fader setting
- AUX bus 1–4 send level
- Effect bus 1–4 pre-fader/post-fader setting
- Effect bus 1–4 send level

**NOTE**

• Pan, effect parameter, and the INSERT EFF settings displayed in the CH VIEW screen View page are not saved to the channel library.

## Calling the Channel Library screen

Channel library save and recall operations are carried out via the CH VIEW screen Library page. To call this page press the Selected Channel section [VIEW] key as many times as necessary, or press the [F2] key after pressing the [VIEW] key. This page contains the following items.

12 Channel Operation

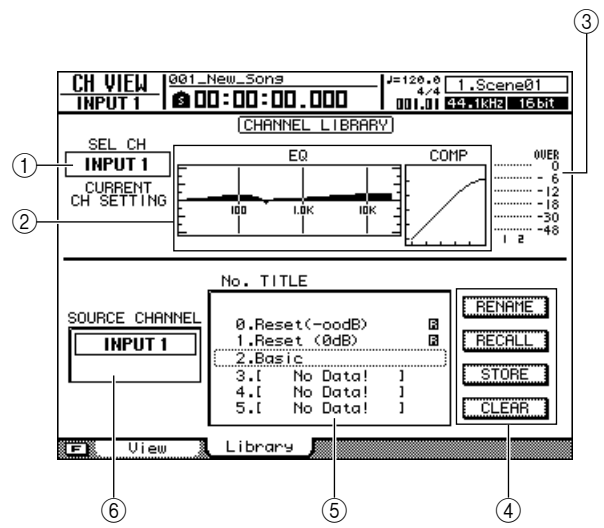

- ① **Selected channel**  
Displays the selected channel.
- ② **EQ/COMP**  
Displays the EQ and compressor settings for the selected channel.
- ③ **Input/Output meter**  
Displays the input levels for the selected channel and adjacent odd-even channel pairs. When the stereo output channel is selected, however, this meter displays the L/R output channel levels.
- ④ **Buttons**  
These buttons execute the RENAME, RECALL, STORE, and CLEAR functions.
- ⑤ **List**  
A list of all the settings stored in the library. The row highlighted by a dotted frame is the setting currently selected for operation. An **F** icon indicates read-only library settings.
- ⑥ **SOURCE CHANNEL**  
Displays the source channel for the settings shown in the library list. "GENERAL" appears for preset data.

**NOTE**

• When data cannot be recalled to the selected channel the "Recall Channel Data Conflict!" error message will appear.

## Changing Channel Library Names

Here's how you can change the names of the settings in the libraries.

- 1 Call the CH VIEW screen Library page by either pressing the [VIEW] key as many times as necessary, or by pressing the [F2] key after pressing the [VIEW] key.

- 2 Use the [DATA/JOG] dial or [INC]/[DEC] keys to select the library setting to be edited.

The setting highlighted by a dotted frame is currently selected for editing.

- 3 Move the cursor to the RENAME button and press the [ENTER] key.

The NAME EDIT popup window will appear.

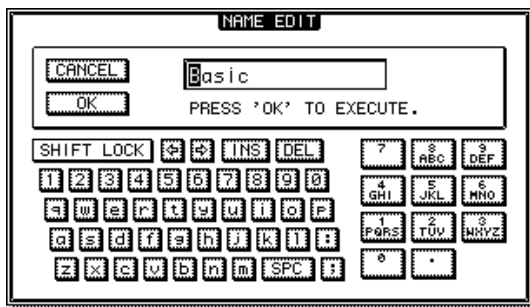

### HINT

- Pressing the [F4] key while holding the Display section [SHIFT] key has the same effect as the RENAME button.

- 4 Enter a name for the selected library setting, move the cursor to the OK button, and press the [ENTER] key (refer to page 32 for details on name entry).

This confirms and enters the new name.

## Storing Channel Library settings

The procedure for storing library settings is as follows.

### NOTE

- New settings cannot be stored to read-only library settings (those marked with an  icon).
- If you select and store to a library number that contains previously-stored data, the previous data will be overwritten.

- 1 Call the CH VIEW screen Library page by either pressing the [VIEW] key as many times as necessary, or by pressing the [F2] key after pressing the [VIEW] key.

- 2 Use the [DATA/JOG] dial or [INC]/[DEC] keys to select the library number to which the settings are to be stored.

The setting highlighted by a dotted frame is currently selected for storage.

- 3 Move the cursor to the STORE button and press the [ENTER] key.

The NAME EDIT popup window will appear.

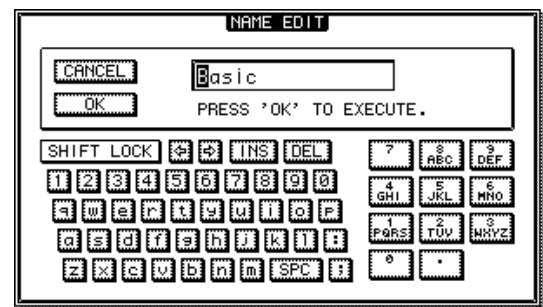

### HINT

- Pressing the [F2] key while holding the Display section [SHIFT] key has the same effect as the STORE button.

- 4 As required, enter a name for the selected library setting, move the cursor to the OK button, and press the [ENTER] key (refer to page 32 for details on name entry).

The library setting will be stored.

## Recalling Channel Library settings

The procedure for recalling stored library settings is as follows.

**1** Call the CH VIEW screen Library page by either pressing the [VIEW] key as many times as necessary, or by pressing the [F2] key after pressing the [VIEW] key.

**2** Use the [DATA/JOG] dial or [INC]/[DEC] keys to select the library setting to be recalled.

The setting highlighted by a dotted frame is currently selected for recall.

**3** Move the cursor to the RECALL button and press the [ENTER] key.

A popup window confirming the recall operation will appear.



- Pressing the [F1] key while holding the Display section [SHIFT] key has the same effect as the RECALL button.

**4** To actually recall the selected setting move the cursor to the OK button and press the [ENTER] key.



- Parameters that do not exist in the target channel will be ignored.
- INSERT EFF settings as shown in the CH VIEW screen View page are not included in the channel libraries and will not change.
- When the target channel is a stereo channel or a channel pair, all parameters except phase and pan will be set to the same values (phase and pan will not change).
- When data cannot be recalled to the selected channel the "Recall Channel Data Conflict!" error message will appear.

## Erasing Channel Library settings

The procedure for erasing unwanted library settings is as follows.



- Read-only library settings (those marked with an  icon) cannot be erased.

**1** Call the CH VIEW screen Library page by either pressing the [VIEW] key as many times as necessary, or by pressing the [F2] key after pressing the [VIEW] key.

**2** Use the [DATA/JOG] dial or [INC]/[DEC] keys to select the library setting to be erased.

The setting highlighted by a dotted frame is currently selected to be erased.

**3** Move the cursor to the CLEAR button and press the [ENTER] key.

A popup window confirming the clear operation will appear.



- Pressing the [F3] key while holding the Display section [SHIFT] key has the same effect as the CLEAR button.

**4** To actually erase the selected setting move the cursor to the OK button and press the [ENTER] key.

# ◆ Chapter 13 ◆

## AUX

This chapter describes operation of the AW2400 AUX buses.

### About the AUX buses

The AW2400 has 4 auxiliary buses that can be assigned to the [OMNI OUT] jacks, the [DIGITAL STEREO OUT] connectors, or the outputs of an optional I/O card installed in the I/O slot. This can be useful for sending signals to external signal processing gear, or for monitoring specific signals within a mix.

Signals from the following channels can be sent to the AUX buses.

- Input channels
- Track channels
- Effect return channels

#### HINT

- Refer to "Output signal patching" on page 104 for details on assigning the AUX bus outputs.
- AUX 1/2 and 3/4 can be assigned as pairs (→ p. 58).

### AUX Send Level Adjustment

AUX send levels can be adjusted either by using the graphic knobs in the AUX screen or by using the Selected Channel section controls.

#### ■ Adjusting AUX send levels via the AUX screen

AUX send levels can be adjusted using the graphic knobs in the AUX screen.

#### 1 Press the Selected Channel section [AUX] key so that its indicator lights.

The AUX screen will appear.

#### NOTE

- If the AUTO DISPLAY function is set to OFF, press one of the Selected Channel knobs (1–4) after pressing the [AUX] key so that its indicator lights. For details about the AUTO DISPLAY function refer to "AW2400 Preferences" on page 210.

#### 2 To adjust levels for the AUX1 bus press Selected Channel knob 1.

The AUX1 screen will appear.

To adjust levels for the AUX2–AUX4 buses press the corresponding Selected Channel knob (2–4) in the same way. If the [AUX] key is lit pressing one of the Selected Channel knobs will take you directly to the corresponding AUX screen.

#### 3 Press the Display section [F1] (Input/RTN page) or [F2] (Track page) key.

The page displays and the items they contain are as follows.

● **AUX screen Input/RTN page**

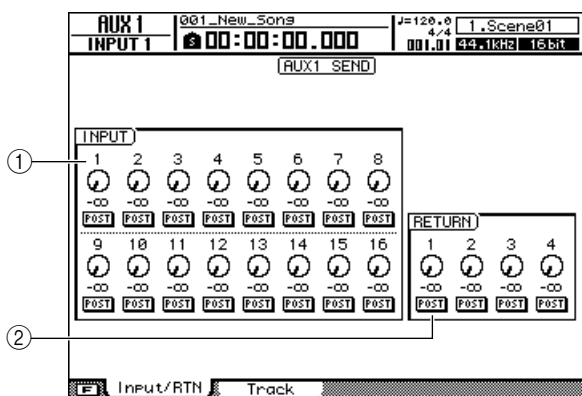

① **INPUT field**

Adjusts the AUX send levels for input channels 1–16. The PRE/POST buttons below each knob can be used to select pre-fader or post-fader send.

② **RETURN field**

Adjusts the AUX send levels for effect return channels 1–4. The PRE/POST buttons below each knob can be used to select pre-fader or post-fader send.

● **AUX screen Track page**

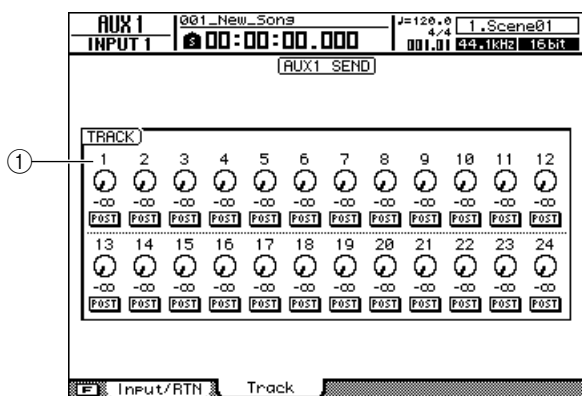

① **TRACK field**

Adjusts the AUX send levels for track channels 1–24. The PRE/POST buttons below each knob can be used to select pre-fader or post-fader send.

**HINT**

- While the [AUX] key is lit you can press one of the Selected Channel knobs repeatedly to switch between the display pages for the corresponding AUX screen. For example, pressing Selected Channel knob 1 repeatedly will switch back and forth between the AUX1 screen Input/RTN page and the Track page.
- By pressing the [F1] or [F2] key while holding the Display section [SHIFT] key you can simultaneously set all channels in the display to PRE ([F1]) or POST ([F2]).

**4 Move the cursor to a knob and use the [DATA/JOG] dial or the [INC]/[DEC] keys to adjust the send level.**

The range is from  $-\infty$  – +10 dB.

**HINT**

- Knobs can also be selected via the Layer section keys, [INPUT SEL] keys, and [SEL] keys.
- Move the cursor to a knob and press the [ENTER] key to turn that AUX send on or off.

**5 To set the point from which the AUX send signal will be derived in each channel, move the cursor to the appropriate PRE/POST button and press the [ENTER] key to select either PRE (pre-fader: the signal is sent from a point before the channel fader) or POST (post-fader: the signal is sent from a point after the channel fader).**

**6 To adjust send levels to a different AUX bus, press the corresponding Selected Channel knob to switch to the appropriate screen, then adjust the send levels as described in steps 4 and 5, above.**

**■ Adjusting AUX send levels via the Selected Channel section**

Selected Channel section knobs 1–4 can be used to directly adjust AUX send levels.

**1 Use the Layer section keys, [INPUT SEL] keys, and [SEL] keys to select the channel for which AUX send level is to be adjusted.**

**2 Press the Selected Channel section [AUX] key so that its indicator lights.**

The AUX screen will appear.

**3 Rotate Selected Channel knobs 1–4.**

This will adjust the AUX send level for the channel selected in step 1.



**HINT**

- If AUTO DISPLAY function is disabled the AUX screen will not appear automatically when step 2, above, is performed, but the AUX send levels can still be adjusted by rotating the Selected Channel knobs.
- If AUTO DISPLAY function is disabled a popup window will appear when a value is adjusted for easy visual confirmation, regardless of the display that is showing at the time.



## Using external effects with the AUX buses

External effect processing gear connected via the [OMNI OUT] jacks can be used in place of the internal effects. The example given in this section describes the procedure for applying an external mono-in/stereo-out reverb processor to a track channel via the AUX1 bus.

**1** Lower the [STEREO] fader to the  $-\infty$  position.

**2** Call the PATCH screen Output page by pressing the Work Navigate section [PATCH] key.

This page is used to assign the AW2400's various internal signals to the output connectors.

**3** Move the cursor to the OMNI OUT ASSIGN 1 field and use the [DATA/JOG] dial or the [INC]/[DEC] keys to select "AUX1".

This assigns the AUX1 bus signal to [OMNI OUT] jack 1.

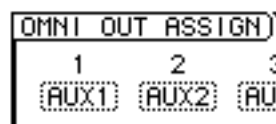

### HINT

- The AUX bus signals can also be assigned to an I/O card installed in the I/O slot, or the [DIGITAL STEREO OUT] connector.

**4** Referring to the diagram, connect the external signal processor to the AW2400.

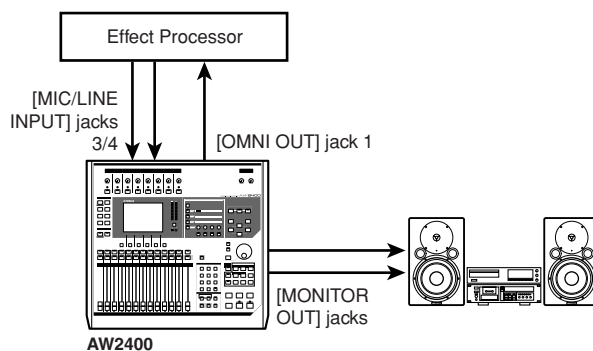

**5** Press the Selected Channel section [AUX] key so that its indicator lights, then press Selected Channel knob 1.

The AUX1 screen will appear.

**6** Press the Display section [F2] key to display the Track page.

The send levels from the track channels to the AUX1 bus can be adjusted via this page.

**7** Set the knobs for each channel to an appropriate level, and set the PRE/POST buttons as required.

At this point the track channel signals are being sent to the [OMNI OUT] jack 1 via the AUX1 bus, and are being fed to the external effect processor's input.

**8** Use the Quick Navigate section [RECORD] key to call the RECORD screen Mixdown page, and set the parameters as shown in the illustration.

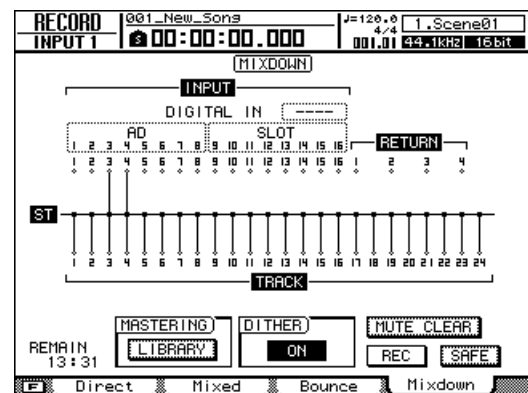

With these settings track channels 1–24 and the effect signals returned to input channels 3/4 are mixed and sent to the stereo bus.

● Signal Flow When Using an External Effect Processor

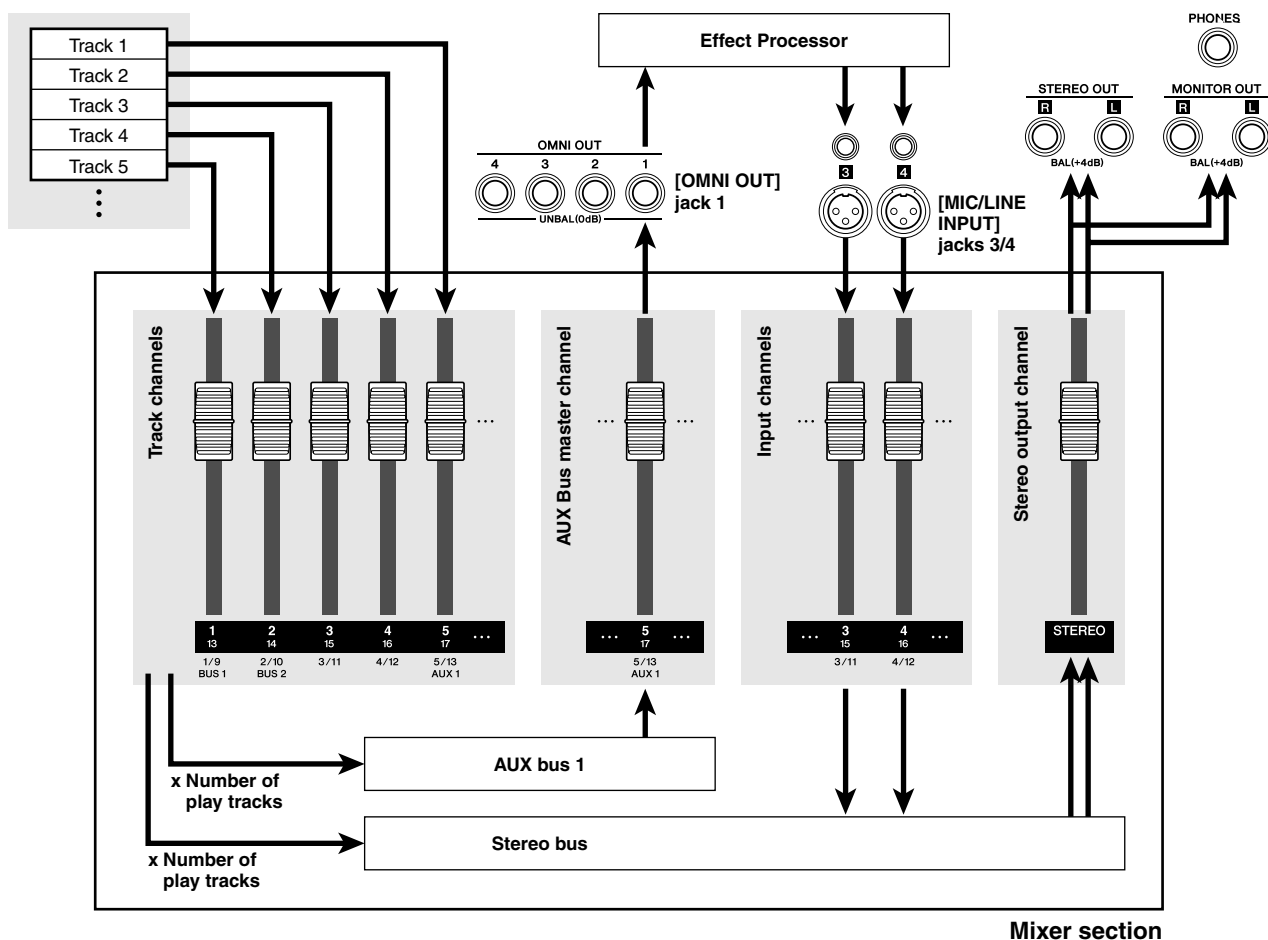

13  
AUX

**9** Press the Selected Channel section [PAN/EQ] key so that its indicator lights, then press Selected Channel knob 1 as many times as necessary to display the PAN/EQ screen Input/RTN page.

**10** Set the input channel 3 and 4 pan controls fully left and right, respectively.

This ensures full stereo effect from the stereo effect processor. You could also pair inputs 3 and 4 for easy stereo control.

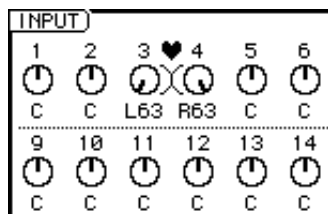

NOTE

• With this setup be sure to set all AUX send levels for input channels 3 and 4 to  $-\infty$  to prevent feedback.

**11** Raise the [STEREO] fader to the 0-dB level and, while playing back the song, adjust the input level of the external effect processor as well as the input levels of input channels 3 and 4 using the [GAIN] knobs.

If necessary return to step 7 and readjust the send levels from the track channels to the AUX1 bus as required. You can also adjust the AUX1 bus master level by selecting the appropriate layer and fader via the Layer section [MASTER] key and channel [SEL] key, or by using the CH VIEW screen View page LVL knob.

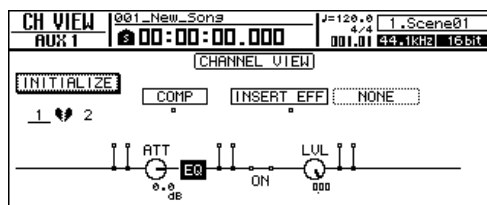

**12** Turn the RECORD screen Mixdown page REC button on and begin the actual mixdown process.

# ◆ Chapter 14 ◆

## Effects

In this section we'll cover operation of the AW2400's internal effects.

### About the Internal Effects

The AW2400 has four independent multi-effect processors built in (Effect 1–4). The internal effects can be used in the following two ways.

#### ■ Effect Sends and Returns

This method uses the mixer section's effect "sends" and "returns". To apply an effect to a channel the channel's effect send controls are used to send the signal to the input of Effect 1–4 via the corresponding effect bus. The output from the effect processor used is returned to the stereo bus or bus 1/bus 2 via the corresponding effect return channel (Effect Return 1–4), and is mixed with the direct sound.

The following diagram shows the input and output signal flow for effects 1–4.

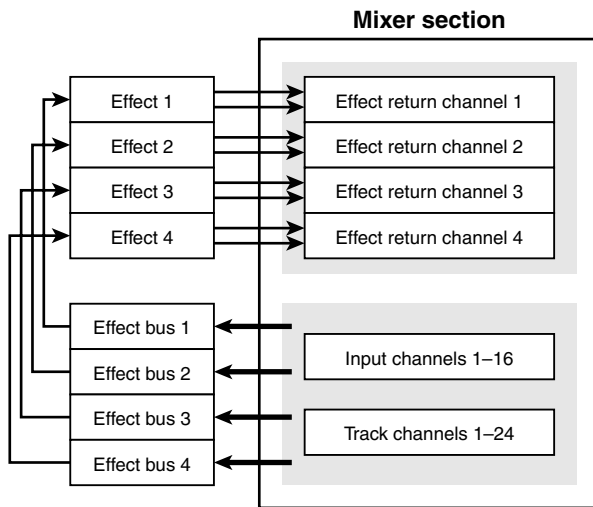

#### ■ Channel Insertion

In this case an effect is inserted into a channel's signal path in order to apply the effect only to that channel. The effect sound is mixed with the direct channel signal within the channel itself and then sent to the stereo bus or a recorder track. Please note that an effect which has been inserted into one channel cannot be simultaneously inserted into another channel or used via the effect sends and returns.

Effects can be inserted on the following channels.

- Input channels
- Track channels
- Stereo output channel
- Bus master channels
- AUX send master channels

Effects can be inserted at any of the following three points in a channel (the diagram shows an input channel).

- ① **Before the EQ stage (pre-EQ).**
- ② **Between the EQ stage and fader (post-EQ pre-fader).**
- ③ **After the fader (post-fader).**

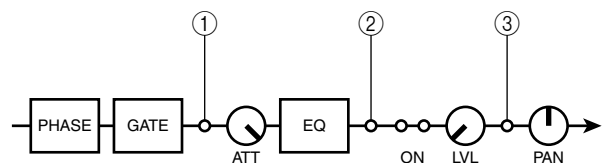

- In addition to the effects provided by the four effect processors, the AW2400 provides a "Pitch Fix" function for correcting the pitch of vocal tracks. Refer to "Correcting a Vocal Track (Pitch Fix)" on page 124 for details.

# Recalling Effect Library settings

The first step in using an effect is to recall a preset from the effect library that uses the required effect.



- The effect type for a recalled effect library preset cannot be changed. For this reason even when you want to program an effect from scratch it is necessary to begin by recalling an effect library preset that includes the effect type you want to use.

## 1 Press the Selected Channel section [EFFECT] key so that its indicator lights.

The EFFECT screen will appear.

## 2 Press Selected Channel knob 1–4, corresponding to the effect processor to which you want to load the effect.

While the EFFECT screen is showing Selected Channel knobs correspond to effect processors 1–4. So, for example, the EFFECT1 screen will be selected if you press Selected Channel knob 1.



- If the AUTO DISPLAY function is set to OFF (→ p. 211), the EFFECT screen will not appear automatically when step 1, above, is performed. In this case press one of the Selected Channel knobs (1–4) will cause the corresponding EFFECT screen to appear.

## 3 Press the Display section [F4] key to call the FX Lib. Page.

You can select the effect library preset to be loaded into the effect processor selected in step 2 via this page.

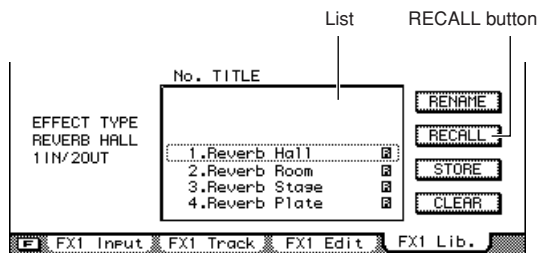

- Library numbers 1–43 contain pre-programmed read-only effect presets.
- Refer to “Effect Library Operations” on page 122 for details on the effect library RENAME, STORE, and CLEAR functions.

## 4 Move the cursor to the List, and use the [DATA/JOG] dial or [INC]/[DEC] keys to select the library setting to be recalled.

The setting highlighted by a dotted frame is currently selected for recall.

## 5 Move the cursor to the RECALL button and press the [ENTER] key.

A popup window confirming the recall operation will appear.

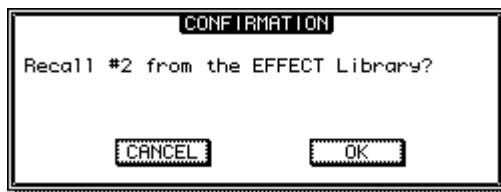

- Pressing the [F1] key while holding the Display section [SHIFT] key has the same effect as the RECALL button.

## 6 To actually recall the selected setting move the cursor to the OK button and press the [ENTER] key.

The library setting will be recalled.

# Applying Effects via Send and Return

The procedure for applying effects 1–4 via the effect sends and returns is described below.

## NOTE

- An effect that has been inserted into a channel cannot be simultaneously used with the effect sends and returns.
- All effects can be used via the effect sends and returns in new song with the initial default settings. If an effect has been inserted in a specific channel it can be removed and freed for use with the sends and returns as described in "Inserting an Effect Into a Channel" on page 119.

**1** Referring to the instructions in "Recalling Effect Library settings" on page 116, recall an effect library preset that is based on the effect you want to use.

**2** Make sure that the Selected Channel section [EFFECT] key is engaged and its indicator is lit.

**3** Make sure that the EFFECT screen selected in step 1 is showing.

Selected Channel knobs 1–4 correspond to EFFECT screens 1–4. Press the appropriate knob to call the desired screen.

**4** To adjust the send level to an effect bus start by pressing the Display section [F1] key to call the FX Input page, or the [F2] key to call the FX Track page.

The FX Input page allows adjustment of the input channel send levels, while the FX Track page allows adjustment of the track channel send levels. The items included in the FX Input and FX Track pages are as follows.

## ● EFFECT screen FX Input page

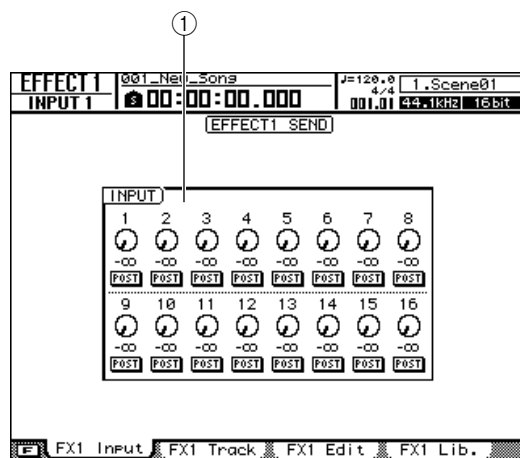

### ① INPUT field

Allows adjustment of the effect send levels for input channels 1–16. You can also select the point from which the send signal is derived via the PRE/POST button below each knob.

## ● EFFECT screen FX Track page

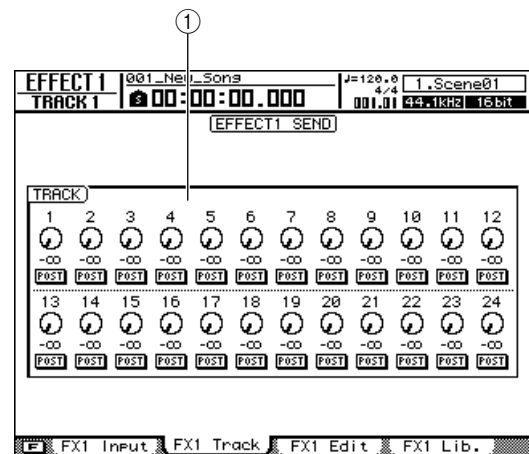

### ① TRACK field

Allows adjustment of the effect send levels for track channels 1–24. You can also select the point from which the send signal is derived via the PRE/POST button below each knob.

## HINT

- When the [EFFECT] key is lit you can repeatedly press a Selected Channel knob to sequentially select the related effect pages.
- By pressing the [F1] or [F2] key while holding the Display section [SHIFT] key you can set all channels within the display to PRE ([F1]) or POST ([F2]) with one operation.

**5** Move the cursor to an effect send knob and use the [DATA/JOG] dial or [INC]/[DEC] keys to set the effect send level.

## HINT

- By moving the cursor to an effect send knob and pressing the [ENTER] key the effect send for that channel can be turned off or on.
- Effect send levels can also be adjusted while the [EFFECT] key is engaged by pressing the [INPUT\_SEL] or [SEL] key for the target channel and using Selected Channel knobs 1–4 to adjust the send level to the corresponding effect processor.

- 6** Move the cursor to the PRE/POST button and press the [ENTER] key to switch the location from which the signal will be sent from each channel to the Effect buses.

Select PRE for pre-fader or POST for post-fader send.

- 7** To adjust the effect mix balance (the balance between the effect and direct signals), press the [F3] key.

The EFFECT screen FX Edit page will appear.

- 8** Use MIX BALANCE field knob to adjust the balance between the direct and effect signals.

When applying an effect via the effect sends and returns the effect mix level is usually set to 100% (effect sound only).



- The effect parameters can be edited as required via the FX Edit page. Refer to “Editing Effects” on page 121 for details.

- 9** The effect send master levels can be adjusted via faders 9–12 after pressing the Layer section [MASTER] key.

When the MASTER mixing layer is selected faders 9–12 control the master send levels for effects 1–4, respectively. You can view and edit the various parameters for each master send channel by pressing [SEL] key 9–12 and then calling the CH VIEW screen View page.

- 10** To adjust the effect return levels press the Layer section [IN 1-8] or [IN 9-16] key, and use faders 9–12 to adjust the corresponding return levels.

When mixing layer IN 1-8 or IN 9-16 is selected faders 9–12 control the return levels for effects 1–4, respectively. You can view and edit the various parameters for each return channel by pressing [SEL] key 9–12 and then calling the CH VIEW screen View page.



- See “Displaying the mix parameters for individual channels” on page 105 for details.

# Inserting an Effect Into a Channel

Effects can be directly inserted into the signal path of specified channels as follows.

**1** Referring to the instructions in “Recalling Effect Library settings” on page 116, recall an effect library preset that is based on the effect you want to use.

**2** Call the CH VIEW screen View page by either pressing the Selected Channel section [VIEW] key as many times as necessary, or by pressing the [F1] key after pressing the [VIEW] key.

The signal flow and mix parameters for each channel are displayed in this page.

**3** Use the Layer section keys, [INPUT SEL] keys, [SEL] keys, or [STEREO SEL] key to select the channel into which the effect is to be inserted.

The signal flow for the selected channel will be displayed.

To insert an effect that is to be used on just one instrument connected to the AW2400, for example, insert the required effect into the appropriate input channel.

The example diagram shows input channel 1 selected for effect insertion.

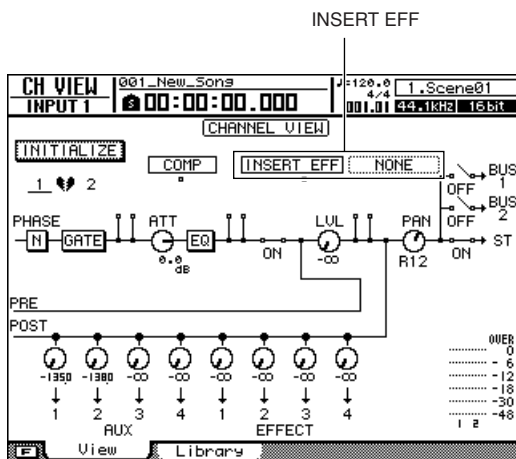

**NOTE**  
• Effects cannot be inserted into the effect send master or effect return channels.

**4** Move the cursor to the field to the right of INSERT EFF on the display and press the [ENTER] key.

A popup window allowing selection of the effect to be inserted as well as an I/O card channel to and from which the signal will be sent/received will appear.

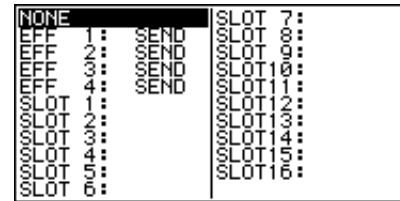

The popup window includes the following items.

- **NONE** ..... No effect inserted.
- **EFF1-4**..... Effect 1-4 inserted.

**NOTE**

- The same effect number can not be selected for multiple channels.
- Inserted internal effects cannot be used with the effect sends and returns.

- **SLOT1-16**..... Select one of these options to insert an external effect unit via an I/O card. If SLOT1 is selected, for example, Output channel 1 of the I/O card is used to send the signal to the external effect processor, and input channel 1 of the same card is used to return the output from the external effect processor to the channel.

**HINT**

- When SLOT1-16 is selected for a stereo channel (stereo output or bus master), an odd-even channel pair (“SLOT 1-2” for example) will be assigned to the stereo channels and inserted.

When an item other than NONE is selected, an abbreviation of the insert destination will appear to the right of the colon (“:”).

The meanings of the abbreviations are as follows.

Abbreviations	Descriptions
SEND (EFF1-4 only)	Effect send/return operation (not inserted in any channel).
IN1-IN16	Inserted in input channel 1-16.
TR1-TR24	Inserted in track channel 1-24.
STEREO	Inserted in stereo output channel.
BUS1-2	Inserted in bus master channel 1, 2.
AUX1-4	Inserted in AUX send master channel 1-4.

- 5** Use the [DATA/JOG] dial or [INC]/[DEC] keys to select the desired effect and/or I/O card channel, then press the [ENTER] key.

When EFF1–4 is selected the corresponding effect will be inserted in the signal path.

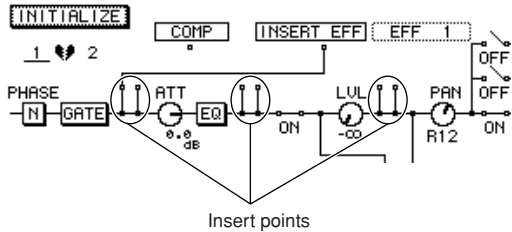

The signal flow is as follows.

- INSERT EFF = EFF 1

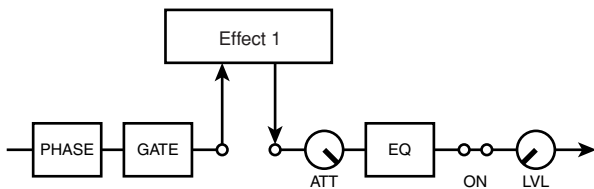

### External effect inserted pre-EQ (input channel)

When SLOT1–16 is selected an external effect processor can be inserted into the channel via the selected I/O card channel. In this case the signal flow is as follows.

- INSERT EFF = SLOT1

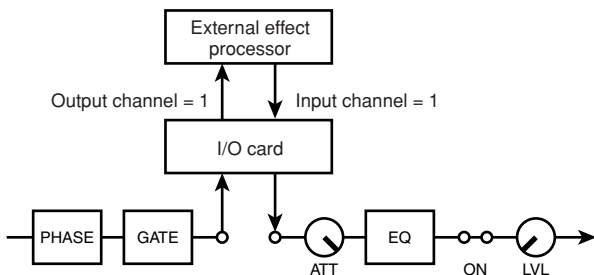

### Internal effect inserted pre-EQ (input channel)

- 6** To select the insert point move the cursor to the  symbol below INSERT EFF on the display and press the [ENTER] key.

Press [ENTER] repeatedly to sequentially select the pre-EQ → post-EQ pre-fader → post-fader insert points.

When an effect and compressor are both inserted at the same point you can move the cursor directly to the insert point and press the [ENTER] key to swap the positions of the effect and compressor.

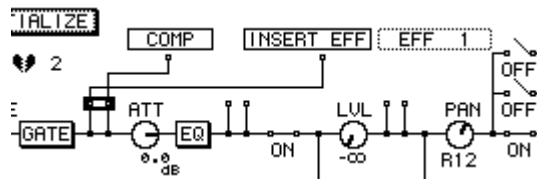

- 7** Call the EFFECT screen FX Edit page or FX Lib. page to adjust the internal effect mix balance (the balance between the effect and direct signals).

- 8** Use the MIX BALANCE field knob to balance the effect and direct sound as required.

A setting of 0% produces only the direct sound while a setting of 100% produces only the effect sound.



• Refer to “Editing Effects” on page 121 for details on the EFFECT screen FX Edit page.



# Editing Effects

The AW2400 internal effect parameters can be edited to create precisely the effect your music requires.

- 1 Referring to the instructions in “Recalling Effect Library settings” on page 116, recall an effect library preset that is based on the effect type you want to use.**
- 2 Make sure that the Selected Channel section [EFFECT] key is engaged and its indicator is lit.**
- 3 Make sure that the EFFECT screen selected in step 1 is showing.**  
Selected Channel knobs 1–4 correspond to EFFECT screens 1–4. Press the appropriate knob to call the desired screen.
- 4 Press the Display section [F3] key to access and edit the effect parameters.**  
The EFFECT screen FX Edit page will appear. This page contains the following items.

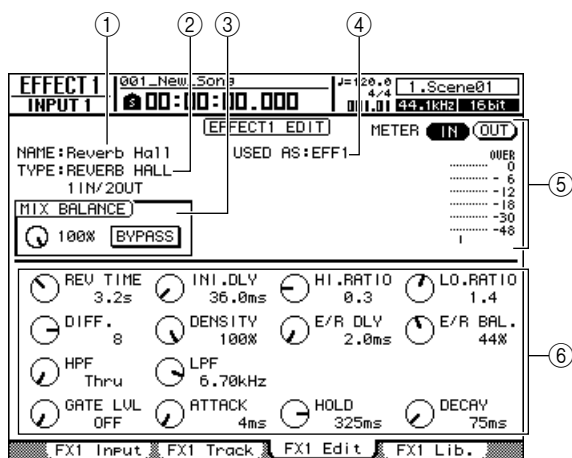

- 1 NAME**  
Indicates the name of the currently selected effect.
- 2 TYPE**  
Indicates the type of the currently selected effect.

**NOTE**

You cannot change the effect type via this page. If you want to use a different type you will need to recall a library setting that uses the desired effect type.

- 3 MIX BALANCE field**
  - **BYPASS button**.....Switches effect bypass on/off.
  - **MIX BALANCE knob**....Sets the balance between the effect and direct signals. 0% produces direct sound only, while 100% produces effect sound only.
- 4 USED AS**  
Indicates how this effect is being used. “EFF1”–“EFF4” indicate that the effect is internally connected to the mixer section via send/return. If the effect is inserted into a specific channel the name of the channel into which the effect is inserted will be shown (e.g., “INPUT 1”).
- 5 Level Meter**  
Displays the effect input or output level. Select input (IN) or output (OUT) via the button above the meters.
- 6 Parameter page**  
In this area you can edit the various effect parameters. The content and range of the parameters will depend on the currently selected effect type.

- 5 Move the cursor to the effect parameter that you want to edit, and use the [DATA/JOG] dial or [INC]/[DEC] keys to edit the value.**  
Depending on the effect type, this area may be used to show multiple parameter pages. In this case repeatedly press the CURSOR [▼] key to access the parameter page that contains the parameter you want to edit.
- 6 To switch effect BYPASS on/off, move the cursor to the BYPASS button and press the [ENTER] key.**

**HINT**

Edited effect settings can be stored in the effect library (→ p. 123).

## Effect Library Operations

The AW2400 provides an effect library for storage and recall of effect settings. Effect library operation is described in this section.

### Call the Effect Library Screen

Effect library save and recall operations are carried out via the EFFECT screen FX Lib. page.

#### 1 Press the Selected Channel section [EFFECT] key so that its indicator lights.

The EFFECT screen will appear.

#### 2 Press one of the Selected Channel section knobs 1–4.

The corresponding EFFECT screen will appear.



- The Effect Library is common to all four internal effect processors, so save and recall operations can be carried out from any EFFECT screen.

#### 3 Press the [F4] key to access the FX Lib. page.

All effect library operations are carried out via the FX Lib. page. The items in this page are as follows.

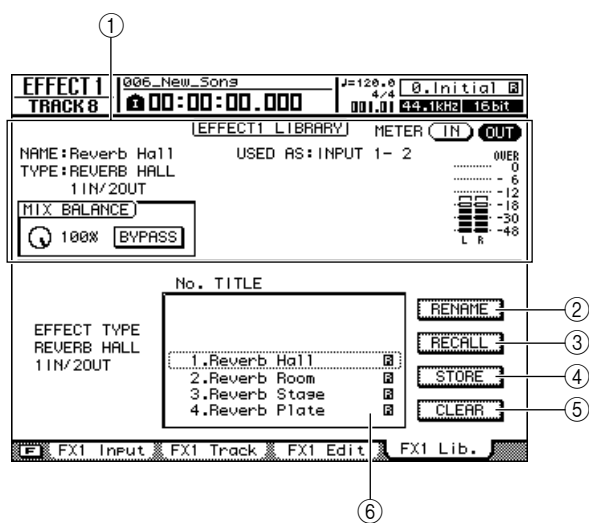

#### ① Current effect information

This is the same as the EFFECT screen FX Edit page (→ p. 121).

#### ② RENAME button

Accesses the NAME EDIT popup window, where you can edit the name of the library selected in the list.

#### ③ RECALL button

Recalls the library data that is selected in the list. Refer to “Recalling Effect Library settings” on page 116 for details on recalling from the library.

#### ④ STORE button

Stores the current effect settings into the location selected in the list.

#### ⑤ CLEAR button

Deletes the library data that is selected in the list.

#### ⑥ List

This area lists the effect data stored in the library. Library numbers 001–043 are read-only, and original settings can be saved to numbers 044–128. The line enclosed by the dotted frame indicates the data that is selected for operation. An  icon indicates a read-only library setup.

### Changing Effect Library Names

Here's how you can change the names of the settings in the Effect library.

#### 1 Call the FX Lib. page.

Refer to “Call the Effect Library Screen” on page 122 for details.

#### 2 Move the cursor to the list, and use the [DATA/JOG] dial or [INC]/[DEC] keys to select the library setting to be edited.

The setting highlighted by a dotted frame is currently selected for editing.

#### 3 Move the cursor to the RENAME button and press the [ENTER] key.

The NAME EDIT popup window will appear.



- Pressing the [F4] key while holding the Display section [SHIFT] key has the same effect as the RENAME button.

#### 4 Enter a name for the selected library setting, move the cursor to the OK button, and press the [ENTER] key (refer to page 32 for details on name entry).

This confirms and enters the new name.

## Storing Effect Library settings

Save the current effect setting from any one of the effect processors (1–4) to the effect library.

### NOTE

- New settings cannot be stored to read-only library numbers (those marked with an **R** icon).
- If store to a library number that contains previously-stored data, the previous data will be overwritten.

- 1 Press the Selected Channel section [EFFECT] key so that its indicator lights.**
- 2 Press one of the Selected Channel section knobs 1–4 to access EFFECT screen for the effect processor that will be the store source.**

- 3 Call the FX Lib. page.**  
Refer to “Call the Effect Library Screen” on page 122 for details.

- 4 Move the cursor to the list, and use the [DATA/JOG] dial or [INC]/[DEC] keys to select the library number to which the settings are to be stored.**

The setting highlighted by a dotted frame is currently selected for storage.

- 5 Move the cursor to the STORE button and press the [ENTER] key.**

The NAME EDIT popup window will appear.

### HINT

- Pressing the [F2] key while holding the Display section [SHIFT] key has the same effect as the STORE button.

- 6 If necessary enter a name for the selected library setting, move the cursor to the OK button, and press the [ENTER] key (refer to page 32 for details on name entry).**

The library setting will be stored.

## Erasing Effect Library settings

The procedure for erasing unwanted library settings is as follows.

### NOTE

- Read-only library settings (those marked with an **R** icon) cannot be erased.

- 1 Call the FX Lib. page.**  
Refer to “Call the Effect Library Screen” on page 122 for details.

- 2 Move the cursor to the list, and use the [DATA/JOG] dial or [INC]/[DEC] keys to select the library setting to be erased.**

The setting highlighted by a dotted frame is currently selected to be erased.

- 3 Move the cursor to the CLEAR button and press the [ENTER] key.**

A popup window confirming the clear operation will appear.



### HINT

- Pressing the [F3] key while holding the Display section [SHIFT] key has the same effect as the CLEAR button.

- 4 To actually erase the selected setting move the cursor to the OK button and press the [ENTER] key.**

# Correcting a Vocal Track (Pitch Fix)

The Pitch Fix function can be used to “fix” the pitch of a vocal track, or create chorus parts based on a main vocal part. An Auto Punch-in/out function is also provided which allows a specified segment of a vocal track to be processed and replaced.

Pitch Fix can be useful in the following situations:

- Correct the pitch of slightly flat or sharp vocals.
- Correct the pitch of a specified segment or phrase of a vocal track using the Auto Punch-in/out function.
- Create a chorus part using an external MIDI keyboard to specify the pitch of the chorus part — a third above the main vocal, for example.
- Change the key of a vocal track.

**NOTE**

If you will be using an external MIDI keyboard to specify the pitch for vocal pitch correction or a chorus part, the MIDI OUT connector of an appropriate MIDI keyboard must be connected to the AW2400 [MIDI IN] connector via a standard MIDI cable. In this case the MIDI screen Setting 1 page PORT RX (reception) parameter must be set to MIDI. Keyboard connection can also be made via the USB port.

**1** When you want to specify a segment of a vocal track to be processed and recorded to another track, it is necessary to specify the In and Out points and press the [AUTO PUNCH] key for the Auto Punch-in/out function.

For details on the Auto Punch-in/out function refer to “Auto punch-in/out” on page 70.

**2** Call the RECORD screen Bounce page by either pressing the Quick Navigate section [RECORD] key as many times as necessary, or by pressing the [F3] key after pressing the [RECORD] key.

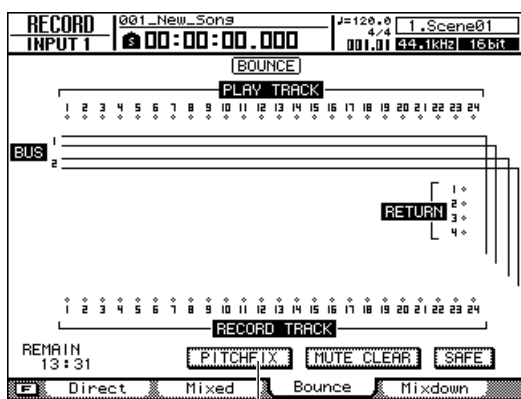

PITCH FIX button

**3** Move the cursor to the PITCH FIX button and press the [ENTER] key.

A popup window will appear which allows you to select the source edit track.

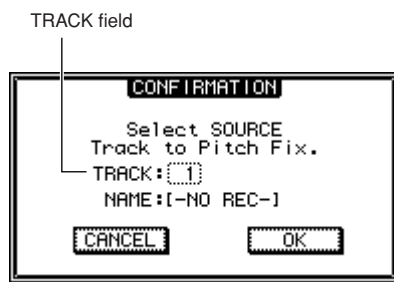

**4** Specify the source edit track in the TRACK field, then move the cursor to the OK button and press the [ENTER] key.

A popup window will appear which allows you to select the record destination track and the virtual track.

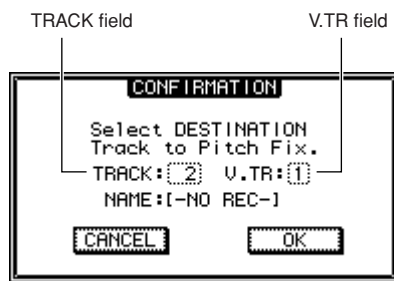

**NOTE**

Different tracks must be specified for the source and destination.

**5 Specify the record destination track in the TRACK field and the virtual track in the V.TR field, then move the cursor to the OK button and press the [ENTER] key.**

This will select the PITCH FIX display.

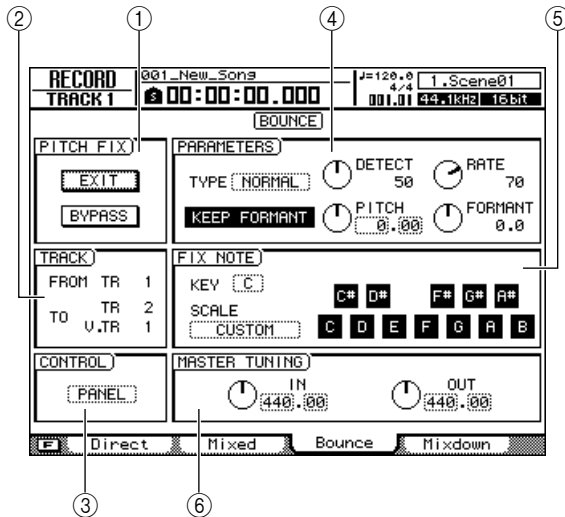

**NOTE**

- The following occur when the PITCH FIX mode is engaged:
  - No other display can be selected from the panel keys.
  - Record track assignments are ignored.
  - No internal effects other than Pitch fix can be accessed.
  - The Automix function is temporarily disabled.
  - MIDI program and control change messages cannot be received.

**1 PITCH FIX field**

- **EXIT button** ..... Move the cursor to this button and press [ENTER] to exit from the PITCH FIX mode and return to the Bounce page.
- **BYPASS button** ..... To monitor the vocal track prior to pitch correction, move the cursor to this button and press [ENTER].

**2 TRACK field**

- **FROM TR** ..... Indicates the track to be edited (the source track). This field is only for display, and cannot be edited.
- **TO TR/TO V.TR** ..... Indicates the track and virtual track to which the processed source track will be recorded (the destination track). This field is only for display, and cannot be edited.

**3 CONTROL field**

Selects the method of pitch correction/shift from the three listed below.

- **SCALE** ..... Specify the scale via received MIDI notes to adjust the pitch. For example, if you play a chord on a connected MIDI keyboard, the pitch is shifted by the notes included in the chord.
- **NOTE** ..... The pitch is changed according to the received MIDI note.
- **PANEL** ..... This lets you adjust the pitch by specifying a scale from the keyboard on the display.

**4 PARAMETERS field**

- **TYPE** ..... Set this to an appropriate value to maximize the accuracy of the pitch correction. Generally this should be set to Normal, but for low-pitched vocals it might be preferable to use the Male setting, and for high-pitched vocals try the Female setting.
- **KEEP FORMANT button** ..... When this button is engaged the basic character (timbre) of the voice will not change when the pitch is corrected.
- **DETECT knob** ..... Determines the pitch detection speed. The shorter the setting, the more quickly the pitch is detected allowing faster response. The longer the setting, the more slowly the pitch is detected which can result in abrupt, step-like pitch changes.
- **RATE knob** ..... This determines the speed of pitch change. The faster the setting, the more quickly the pitch is changed so that pitch correction more accurately tracks the original signal. When this is set to "000," there is no pitch change.
- **PITCH knob** ..... This determines the octave setting of the pitch-adjusted signal. The range is from -2 to 2 octaves in semitone steps. The integer and fraction segments of the value are set separately.
- **FORMANT knob** .. This determines the vocal character (timbre) of the pitch-adjusted signal. Positive (+) values result in a higher voice character and negative (-) values result in a deeper voice character.

⑤ **FIX NOTE field**

These parameters are only available when PANEL is selected in the CONTROL field.

- **KEY**.....Sets the key of the graphic keyboard on the display.
- **SCALE**.....Sets the scale of the graphic keyboard on the display: CHROMATIC, MAJOR, MINOR, or CUSTOM. When CUSTOM is selected the keyboard's buttons can be used to directly specify a scale for pitch correction.

⑥ **MASTER TUNING field**

- **IN/OUT knob** .....The IN knob sets the reference pitch before correction, and the OUT knob sets the reference pitch after correction. The integer and fraction segments of the value are set separately.



- When the BYPASS button is engaged the signal before pitch correction is output unaffected, regardless of the IN and OUT knob settings.

6 **Raise the [STEREO] fader and the fader of the source track channel to about 0dB on the scale.**

7 **Raise the fader of the destination track channel to about 0dB on the scale.**



- The fader of the destination track — the track to which the processed vocal track will be recorded — has no effect on the recorded signal. The source track fader determines the final balance, so set it with care.

8 **To set the scale for pitch correction select PANEL in the CONTROL field and specify the key in the FIX NOTE field.**

For example, if PANEL is selected in the CONTROL field and CHROMATIC is selected in the FIX NOTE SCALE field, pitch will be corrected to the nearest note in the chromatic (semitone) scale. You can also specify the notes to be used for pitch correction by selecting CUSTOM in the FIX NOTE SCALE field and specifying the notes via the on-screen keyboard.

9 **Press the RTZ [◀] key to rewind the song to the beginning, then press the PLAY [▶] key while holding the REC [●] key.**

Song playback will begin and the processed data will be recorded to the destination track.

The corrected signal can be monitored via the record destination track channel.



- The source track (the signal before correction) cannot be monitored while the PITCH FIX mode screen is showing. Also note that the record destination (the corrected signal) can only be monitored when the recorder is set to the record mode.
- When Auto Punch-in/out is engaged, you can monitor the destination channel during playback even when not recording.
- To check the signal before pitch correction, engage the BYPASS button to temporarily disable the Pitch Fix effect.

10 **Adjust the DETECT, RATE, and PITCH parameters as required while recording the song.**

If NOTE is selected in the CONTROL field, you can use a MIDI keyboard to specify the pitches for pitch correction in real time while recording. This capability can be useful when creating a harmony vocal track based on the original vocal melody.



- For optimum effect use the DETECT knob in addition to the RATE knob in order to set the "depth" of the pitch correction effect.
- You can create "robot voice" type effects by setting the RATE and DETECT knobs to high values and using a MIDI keyboard to trigger sudden pitch changes.

11 **When the end of the song is reached, rewind the song and press the PLAY [▶] key.**

The recorded pitch-corrected track will play back with the other recorded tracks (the original uncorrected track will not play back).

If you're not satisfied with what has been recorded, press the [UNDO/REDO] key to undo the recording and go back to step 9.

12 **Move the cursor to the EXIT button and press [ENTER].**

A popup window will appear asking you to confirm that it's OK to exit from the PITCH FIX mode.



13 **To return to the Bounce page move the cursor to the OK button and press the [ENTER] key.**

The PITCH FIX mode will be exited and the Bounce display will appear.

# ◆ Chapter 15 ◆

## Track operations and editing

This chapter explains how to use and edit the tracks of the recorder section.

### About the AW2400's tracks

The AW2400 has the following types of track.

#### ● Audio Tracks

The physical tracks used to record and play back audio data are called “audio tracks,” or simply “tracks.” The AW2400 has twenty-four audio tracks.

#### ● Stereo Track

Independently from audio tracks 1–24, the AW2400 has a “stereo track” that records and plays a stereo audio signal. The stereo track is used mainly as a dedicated mixdown track for recording the final mix.

#### ● Virtual Tracks

Each audio track 1–24 and the stereo track consists of eight tracks. Each of these eight tracks is called a “virtual track.” For the audio tracks and the stereo track, only one virtual track can be recorded or played at any time. The diagram below shows the concept of virtual tracks. The horizontal rows indicate audio tracks 1–24, and the vertical columns correspond to virtual tracks 1–8. The shaded areas indicate the virtual track that is currently selected for recording or playback.

#### ● Trigger Tracks

The “Trigger Track” function allows the track [ON] keys and faders to be used to start and stop playback of recorded tracks. When the Trigger Track function is active pressing a track channel [ON] key begins playback of the corresponding track from the beginning of the song to the end of the data recorded on that track.

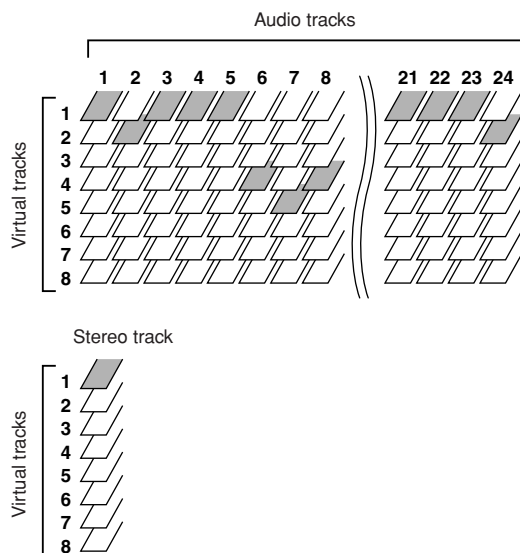

# Audio track operations

## About audio tracks

Audio tracks are physical recording areas used to record and play back audio data.

The AW2400 lets you use 24 audio tracks. In a 16-bit song you can play back up to 24 tracks simultaneously, and in a 24-bit song you can play back up to 12 tracks simultaneously. However, the number of tracks that can actually be played back simultaneously is limited by the number of tracks that are currently in record-ready mode. Please note that putting more tracks in record-ready mode will forcibly mute a corresponding number of playback tracks. The following table shows the number of tracks that can be simultaneously recorded/played for a 16-bit or 24-bit song.

Song Bit Depth	Max. Simultaneous Record Tracks	Max. Simultaneous Play Tracks
16 bits	16	8
	:	:
	1	23
	0*	24*
24 bits	8	4
	:	:
	1	11
	0*	12*

\* For mixdown the number of simultaneous record tracks is two, and the number of simultaneous playback tracks is 24 for 16-bit songs, or 12 for 24-bit songs.

For example in a 16-bit song, each track you place in record-ready mode will decrease the number of simultaneously-playable tracks by one. (Muting will begin with higher-numbered tracks.) If you've placed the maximum of sixteen tracks in record-ready mode, a maximum of eight tracks can be played back simultaneously. If you want to return a muted track to playable condition, you must first reduce the number of tracks that are in record-ready mode, and then defeat muting on the track you want to play back.

## Viewing all audio tracks

In the TRACK screen View page you can view all tracks to see whether they contain data, and switch muting on/off for each track.

To call this page press the Work Navigate section [TRACK] key as many times as necessary, or press the [F1] key after pressing the [TRACK] key.

This page contains the following items.

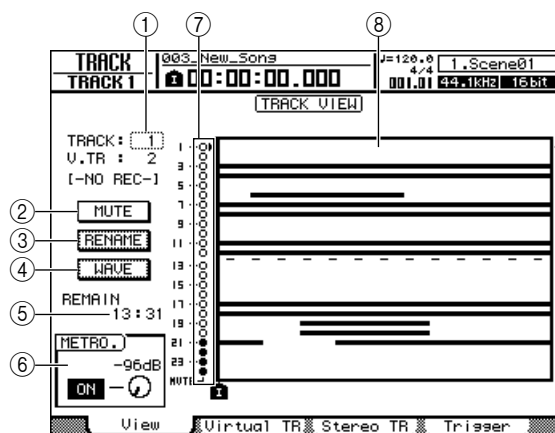

### ① TRACK

Here you can select the track to be controlled in the screen. Choose from 1–24 (audio tracks 1–24) or ST (stereo track). The number and name of the virtual track selected for the current track are shown below this field.

### ② MUTE button

You can move the cursor to this button and press the [ENTER] key to switch muting on/off for the currently selected track.

### ③ RENAME button

You can move the cursor to this button and press the [ENTER] key to access the NAME EDIT popup window, where you can edit the name of the currently selected track.

### ④ WAVE button

If you move the cursor to this button and press the [ENTER] key, the waveform of the currently selected track will be displayed. For details, refer to “Finding a location while viewing the waveform” (→ p. 95).

### ⑤ REMAIN

This indicates the remaining recordable time.

### ⑥ Metronome button/knob

Here you can switch the metronome on/off and adjust the volume. The volume can be adjusted in a range of -96 to +12 dB. For details, refer to “Using the Metronome” (→ p. 62).

### ⑦ MUTE indicator

If a track is muted, its MUTE indicator changes to “●”.

### ⑧ Track View

This area shows whether tracks 1–24 contain data, and indicates the marker locations.



## Muting a specific audio track

- 1 Call the TRACK screen View page.
- 2 Move the cursor to the TRACK field, and use the [DATA/JOG] dial or the [INC]/[DEC] keys to select the number of the track you want to mute.
- 3 Move the cursor to the MUTE button and press the [ENTER] key.

Muting will be switched on/off.

If a track is muted, the MUTE symbol changes to “●”.

When you press the [ENTER] key once again, muting will be defeated and the MUTE symbol will change to “○”.



- This mute function switches muting on or off for the recorder track playback. This also affects the number of simultaneous playback tracks in the recorder section (→ p. 128). It's a good idea to mute all unused tracks.
- Since 24-bit songs allow a maximum of 12 playback tracks, mute cannot be disengaged for tracks 13-24.
- In some cases, depending on the number of tracks that are in record-ready mode, you won't be able to un-mute a track. In this case, decrease the number of tracks that are in record-ready mode, and then un-mute the desired track.

## Switching the virtual track of an audio track

- 1 Call the TRACK screen Virtual TR page by either pressing the Work Navigate section [TRACK] key as many times as necessary, or by pressing the [F2] key after pressing the [TRACK] key.

This page contains the following items.

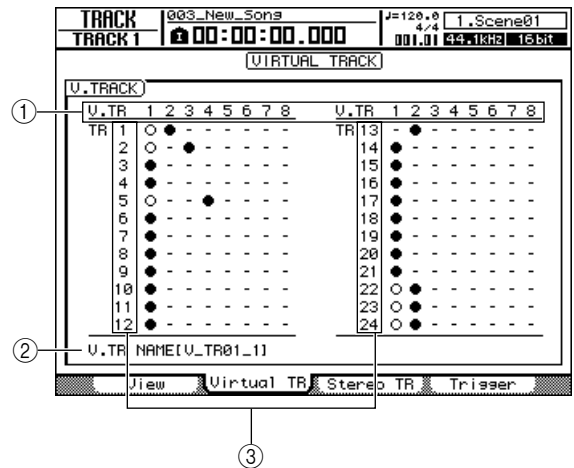

### ① Virtual tracks

Indicates the status of virtual tracks 1–8. The virtual track that is currently selected for each track is indicated by a “●” symbol. Of the virtual tracks that are currently not selected, those that have been recorded are indicated by “○”, and those that have not yet been recorded are indicated as “-”.



- When the AW2400 is in its default state, virtual track 1 is selected for every track.

### ② Virtual track name

This indicates the name of the virtual track selected by the cursor. This will indicate “-NO REC-” for tracks on which nothing has been recorded.

### ③ Tracks

Indicates the track number 1–24.

- 2 Use the cursor keys to select the virtual track number that you want to assign to the desired track.

- 3 Press the [ENTER] key.

The “●” symbol will be displayed at the position of the newly-selected virtual track. This virtual track will now be used for recording/playback.



- To switch the virtual track of the stereo track, use the TRACK screen Stereo TR page.

## Editing virtual track names for an audio track

Here's how to assign a name to the virtual track that is currently selected for an audio track.

- 1 Call the TRACK screen View page by either pressing the Work Navigate section [TRACK] key as many times as necessary, or by pressing the [F1] key after pressing the [TRACK] key.

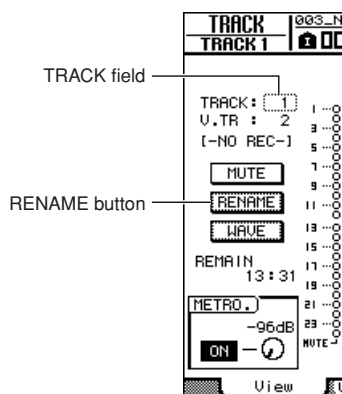

- 2 Move the cursor to the TRACK field, and use the [DATA/JOG] dial or the [INC]/[DEC] keys to select the number of the track whose name you want to edit.

You can edit the name of the currently-enabled virtual track for the track you selected in the TRACK field.

- 3 Move the cursor to the RENAME button and press the [ENTER] key.

The NAME EDIT popup window will appear, allowing you to assign a name to the virtual track.

- 4 Edit the name of the virtual track, move the cursor to the OK button and press the [ENTER] key. (For details on editing a name → p. 32)

The edited name will be applied.

## Stereo track operations

### About the stereo track

Independently from audio tracks 1–24, the AW2400 has a “stereo track” that records and plays a stereo audio signal. The stereo track is used mainly as a dedicated mixdown track for recording the final mix.

The signal of the stereo output channel is always connected to the stereo track; you will always be able to record the signal of the stereo bus simply by putting the stereo track in record-ready mode.

You cannot record audio tracks while recording the stereo track. While the stereo track is playing, audio tracks 1–24 will be forcibly muted.

In the TRACK screen Stereo TR page you can check whether the stereo track contains data, and switch the virtual track for the stereo track. To call this page press the Work Navigate section [TRACK] key as many times as necessary, or press the [F3] key after pressing the [TRACK] key.

This page contains the following items.

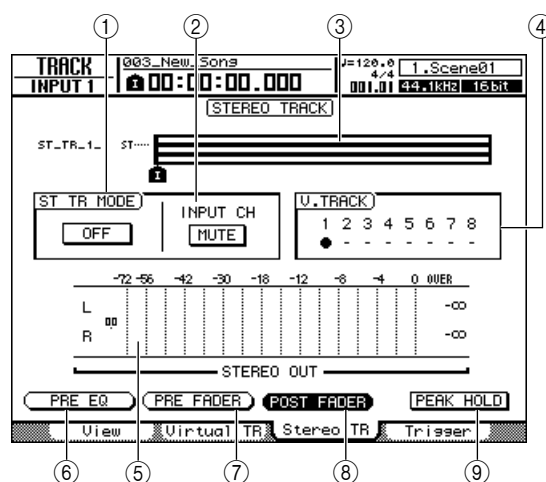

**① ST TR MODE ON/OFF button**

This switches playback of the stereo track on/off.

**② INPUT CH MIX/MUTE button**

This selects whether the signals of the input channels will be monitored (MIX) or will not be monitored (MUTE) while the stereo track is playing.

**③ Track View**

This area graphically indicates whether the stereo track contains data, and indicates the marker locations.

**④ Virtual tracks**

Here you can select the virtual track that is assigned to the stereo track. The currently selected virtual track is indicated by a “●” symbol. Of the other virtual tracks, those that have been recorded are indicated by “○”, and those that have not been recorded are indicated by “-”.

**⑤ Level meter**

This indicates the output level of the stereo track. The fader level is numerically indicated at the left of the meter, and the hold level is numerically indicated at the right.

**⑥ PRE EQ button**

Pre-EQ levels (levels prior to the EQ stage) are displayed when this button is on.

**⑦ PRE FADER button**

Pre-fader levels (levels prior to the faders) are displayed when this button is on.

**⑧ POST FADER button**

Post-fader levels (levels after the faders) are displayed when this button is on.

**⑨ PEAK HOLD button**

This button switches the level meter peak hold function on/off.

## Recording on the stereo track

Here's how to send the signals from track channels, input channels, and effect return channels to the stereo bus, and record the mixed signal onto the stereo track.

### 1 Call the RECORD screen Mixdown page by either pressing the Quick Navigate section [RECORD] key as many times as necessary, or by pressing the [F4] key after pressing the [RECORD] key.

When you access this page, record-ready status will be defeated for all audio tracks, and only the stereo track will be recordable.

Use the Mixdown page to patch the channels that you want to record on the stereo track to the stereo bus. For details on patching, refer to page 75.

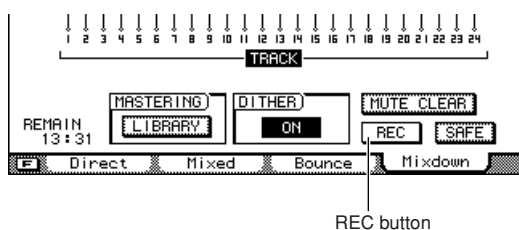

### 2 Move the cursor to the REC button and press the [ENTER] key to turn the button on.

The panel [STEREO SEL] key will blink red. This blinking indicates that the stereo track is in record-ready mode.

### 3 Press the RTZ [⏮] key to rewind the song. Then hold down the REC [●] key and press the PLAY [▶] key.

The song will begin playing, and the playback will be recorded on the stereo track.

### 4 When you reach the end of the song, press the STOP [■] key.

To listen to the recorded result, refer to “Playing back the stereo track” (following section).



- If desired, you can use the [UNDO/REDO] key to cancel the recording that was made on the stereo track (→ p. 64), or switch virtual tracks and record another take.

## Playing back the stereo track

Here's how to play back the stereo track that you've recorded.

### 1 Call the TRACK screen Stereo TR page by either pressing the Work Navigate section [TRACK] key as many times as necessary, or by pressing the [F3] key after pressing the [TRACK] key.

### 2 To play back the stereo track, switch the ST TR MODE ON/OFF button to ON.

When this button is on, the output of the stereo track is sent to a point immediately before the [STEREO] fader, and can be monitored from the [STEREO OUT] jacks, [MONITOR OUT] jacks, and [PHONES] jack. At this time, record-ready status for all tracks will be defeated.



- If any audio tracks are in record-ready mode, a popup window will ask you to confirm that record-ready status will be cancelled.
- If the INPUT CH MIX/MUTE button is set to MIX, you'll be able to monitor the signal of the input channels even while the stereo track is playing.



- EQ and dynamics processing are not applied to the stereo track playback.

### 3 Press the RTZ [◀] key to rewind the song, and press the PLAY [▶] key.

The stereo track will play back. Use the [STEREO] fader to adjust the monitor level.

To return to normal playback of the audio tracks, switch the ST TR MODE ON/OFF button back OFF.

#### HINT

- If the ST TR MODE ON/OFF button is ON, pressing the [RECORD] key while the recorder is stopped will display a popup window asking you to confirm that you want to defeat stereo track playback mode. If you want to do so, move the cursor to the OK button and press the [ENTER] key.

## Switching the virtual track of the stereo track

### 1 Call the TRACK screen Stereo TR page by either pressing the Work Navigate section [TRACK] key as many times as necessary, or by pressing the [F3] key after pressing the [TRACK] key.

### 2 Use the CURSOR keys to select the virtual track number that you want to assign.

The currently selected virtual track is indicated by a “●” symbol. Of the other virtual tracks, those that have been recorded are indicated by “○,” and those that have not yet been recorded are indicated by “—.”

### 3 Press the [ENTER] key.

The “●” symbol will be displayed at the position of the newly-selected virtual track. This virtual track will now be used for recording/playback.

## Editing the name of a virtual track for the stereo track

Here's how to edit the name of the virtual track currently selected for the stereo track.

### 1 Call the TRACK screen View page by either pressing the Work Navigate section [TRACK] key as many times as necessary, or by pressing the [F1] key after pressing the [TRACK] key.

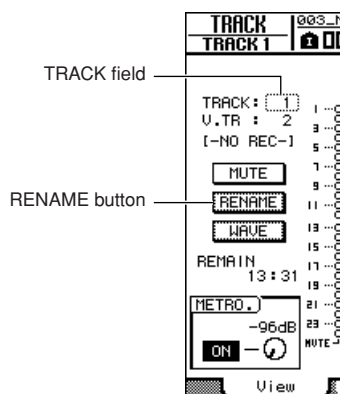

### 2 Move the cursor to the TRACK field, and use the [DATA/JOG] dial or the [INC]/[DEC] keys to make it read “ST.”

You can edit the name of the virtual track that is currently enabled for the stereo track.

### 3 Move the cursor to the RENAME button and press the [ENTER] key.

The NAME EDIT popup window will appear, allowing you to assign a name to the virtual track.

### 4 Edit the name of the virtual track, move the cursor to the OK button, and press the [ENTER] key. (For details on entering a name → p. 32)

The edited name will be finalized.

# The Trigger Track Function

Operation of the Trigger Track function is described in this section.

## About Trigger Track

The “Trigger Track” function allows the track [ON] keys and faders to be used to start and stop playback of recorded tracks. This is ideal for performance situations in which you want to switch phrases or patterns in real time, or when you need to start background music on cue, for example.

When the Trigger Track function is active pressing a track channel [ON] key begins playback of the corresponding track from the beginning of the song to the end of the data recorded on that track (blank sections in the middle of the track will be played normally.) The track is played once.

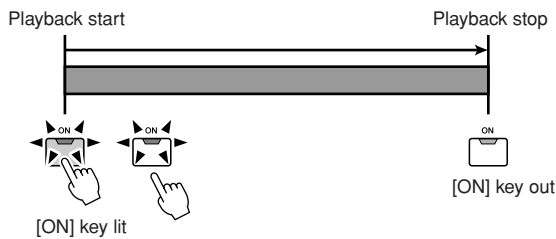

If you press the [ON] key once again during playback the playback will be stopped. Pressing the STOP [■] key will stop playback of all tracks.

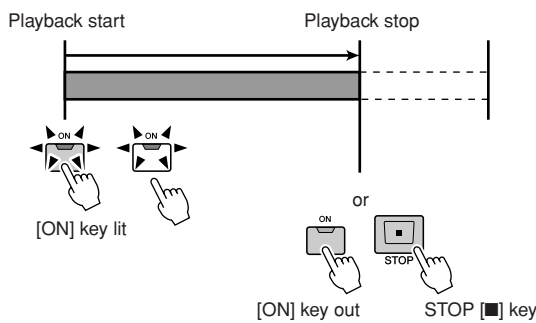

Recorded tracks can be registered in up to four groups (A–D), and playback of those tracks can then be started and stopped as a group. In this case pressing the [ON] key for any track in the group will start playback of the entire group. Press the [ON] key a second time to stop playback of the group.

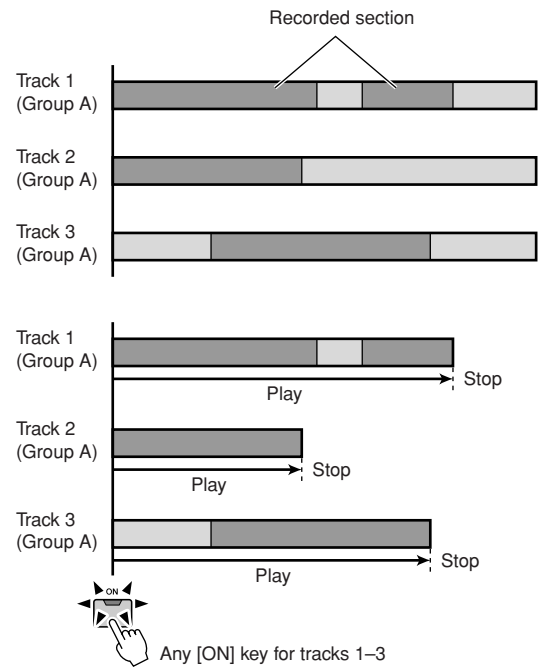

The faders can be used to start playback instead of the [ON] keys (the Fader Start function). Playback of a track (or group including the track) will start from the beginning of the song when a track fader for which the Fader Start function is turned on is raised above the  $-\infty$  position. Playback will stop at the end of the recorded data. Playback can be stopped by returning the fader to the  $-\infty$  position.



NOTE

- When the Trigger Track function is active the Transport, Locate, and Locate/Navigate section keys (with the exception of the STOP [■] key) will not function, and normal record/playback operations are not available.

HINT

- The Trigger Track settings are saved individually with each song.
- When a song is saved with the Trigger Track function active, the Trigger Track function will still be active and a message indicating that status will appear when that song is later recalled.

## Using the Trigger Track Function

The Trigger Track function can be used as described below.

- 1 Call the TRACK screen Trigger page by either pressing the Work Navigate section [TRACK] key as many times as necessary, or by pressing the [F4] key after pressing the [TRACK] key.

This page contains the following items.

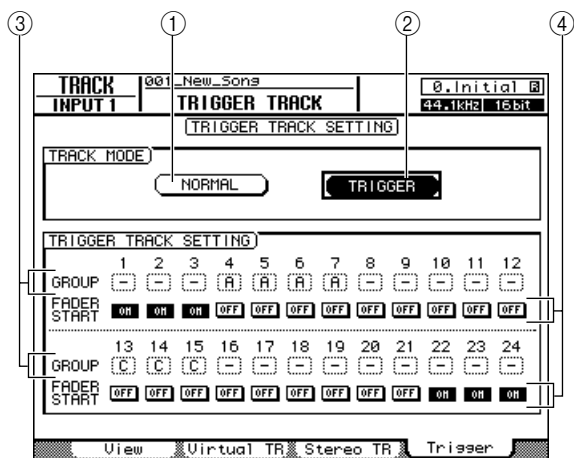

1 NORMAL button

For normal audio track operation this button should be turned on (normal track mode).

2 TRIGGER button

Turn this button on to engage the Trigger Track mode (trigger track mode).

3 GROUP

Move the cursor to this field and use the [DATA/JOG] dial or [INC]/[DEC] keys to set the trigger track group for each track. Groups can only be assigned when the Trigger Track mode is engaged.

4 FADER START button

When this button is on playback of the corresponding track (or group including the track) will start when the track fader is raised above the  $-\infty$  position. Playback will stop at the end of the recorded data. Playback can be stopped by returning the fader to the  $-\infty$  position. This button can only be turned on or off when the Trigger Track mode is engaged.

- 2 Move the cursor to the TRIGGER button and press the [ENTER] key to engage the Trigger Track mode.

A popup window asking you to confirm that you want to exit from the normal track mode will appear. Move the cursor to the OK button and press the [ENTER] key.

NOTE

- Since a maximum of 12 tracks can be played back for 24-bit songs ( $\rightarrow$  p. 165), mute cannot be disengaged for tracks 13–24 and they will remain in the normal track mode.

- 3 To set the group to which each track belongs move the cursor to the GROUP field and use the [DATA/JOG] dial or [INC]/[DEC] keys.

The Trigger Track mode allows each track to be assigned to one of four groups A–D so that playback of entire groups of tracks can be started and stopped by simply pressing one [ON] key or operating one fader.

HINT

- “\_” will be displayed for tracks that are not assigned to a group, and those tracks will be triggered independently.
- Channel pairs to be used for linked stereo operation should be assigned as paired channels beforehand ( $\rightarrow$  p. 58).

- 4 To engage the Fader Start function for a track move the cursor to the FADER START button and press the [ENTER] key.

When the Fader Start function is on, playback of the corresponding track (or group including the track) will start when the track fader is raised above the  $-\infty$  position. Playback can be stopped by returning the fader to the  $-\infty$  position.

HINT

- The Fader Start function can be turned off for all tracks by pressing the [F1] key while holding the [SHIFT] key (“\_” will be displayed for all tracks).
- The Trigger Track group A–D settings can be copied to fader groups ( $\rightarrow$  p. 82) by pressing the [F2] key while holding the [SHIFT] key. This can be useful for linking fader start operation of multiple trigger tracks.

**5** Use the Layer section [TRACK 1-12] and [TRACK 13-24] keys to select the mixing layer to be operated.

**6** Start playback of the target track or group by pressing the appropriate [ON] key or operating the appropriate fader.

The [ON] keys of triggered tracks will light during playback. If you press a lit [ON] key playback of that track or the group that includes that track will stop. Pressing the STOP [■] key will stop playback of all tracks.



- If a channel is turned off by pressing the [ON] key before the Trigger Track mode is engaged, operating the appropriate [ON] key or fader does not play back the channel.

**7** Move the cursor to the NORMAL button and press the [ENTER] key to exit from the Trigger Track mode and return to the normal mode.

A popup window asking you to confirm that you want to exit from the Trigger Track mode will appear. Move the cursor to the OK button and press the [ENTER] key.



- If you attempt to select the RECORD, EDIT, SOUND CLIP, CD, AUTOMIX, or USB screen while the Trigger Track mode is engaged a confirmation popup window will appear. To actually move to the selected screen move the cursor to the OK button and press the [ENTER] to switch to the normal track mode. You cannot select any of the above screens during song playback.

## Editing tracks

This section explains how to edit the audio data recorded on an audio track. The AW2400 provides various editing commands that let you edit the audio tracks that have been recorded. Using these commands, you can specify the track or region that you want to edit, and delete or move data. You can use special commands to import audio data or WAV files from outside the AW2400, or to export WAV files to an external device.

The AW2400 provides the following editing commands.

### ● ERASE

Erases the data of the specified region.

### ● DELETE

Deletes the data of the specified region. Any data that follows the deleted region will be moved forward by the corresponding distance.

### ● INSERT

Inserts blank space into the specified region.

### ● COPY

Copies the data from the specified region to the desired location of the desired track.

### ● MOVE

Moves the data from the specified region to the desired location of the desired track. The move-source data will be erased.

### ● EXCHANGE

Exchanges data between the specified tracks.

### ● TIME COMP (Time Compression/Expansion)

Adjusts the length of the specified region of an audio track without affecting its pitch.

### ● PITCH (Pitch Change)

Adjusts the pitch of the specified region of an audio track without affecting its length.

### ● IMPORT CD AUDIO

Imports audio data (CD-DA) from CD-R/RW media in the CD-RW drive into an audio track of the AW2400.

### ● IMPORT CD WAV

Imports a WAV file from CD-R/RW media in the CD-RW drive into an audio track of the AW2400.

### ● IMPORT USB WAV

Imports a WAV file copied from a computer into the “Transport” folder into an audio track of the AW2400.

### ● IMPORT TRACK

Imports audio data recorded in another song into an audio track of the current song.

### ● EXPORT

Exports the specified region of an audio track to a WAV file in the “Transport” folder.

Here are some ways in which you can use these editing commands.

① **Erase unwanted regions**

You can use the ERASE command to erase just a specific region of a specific track. For example, this provides a convenient way to erase a few wrong notes from a performance, or to eliminate noise that occurred while an instrument was not playing.

② **Change the structure of the tracks**

You can use the EXCHANGE command to exchange an entire track with another track. By using this command you can bring tracks of widely separated track numbers closer to each other for easier operation during mixdown. You can use the COPY or MOVE commands to copy/move the specified region of a track to a different track. This is convenient when you have recorded a solo part among two or more virtual tracks, and want to assemble the best parts into a single track.

③ **Change the structure of the song**

You can use the DELETE or COPY commands to delete/copy entire tracks, changing the structure of the song itself. Even after all parts of the song have been recorded, you can use this method to adjust the length of the song, for example by shortening the number of measures or increasing the number of choruses.

④ **Create special effects**

You can also use editing commands to create special effects. For example, you can copy a guitar or vocal solo part to another track and use the PITCH CHANGE command to slightly detune one of these tracks, creating a chorus effect without using the internal effect processor. By applying the PITCH CHANGE command to a drum track to lower the pitch, you can create a unique lo-fi effect.

## Basic procedure for track editing

Here is the basic procedure for using a track editing command. The procedure is essentially the same for all track editing commands.

### Select the editing command

1 Call the EDIT screen Edit page by either pressing the Work Navigate section [EDIT] key as many times as necessary, or by pressing the [F1] key after pressing the [EDIT] key.

This screen displays the following information.

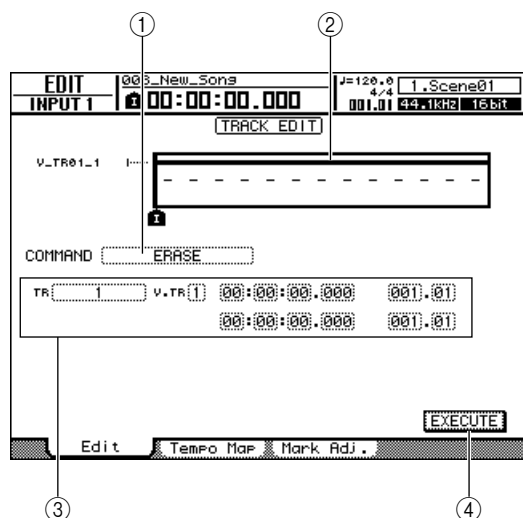

① **Editing command**

Indicates the currently selected editing command.

② **Locator/marker**

Indicates the approximate location of the currently set locate points and markers. This also indicates whether recorded data exists in the current track of each track.

③ **Parameters**

Sets various parameters (track/virtual track number, editing region, etc.) required in order to execute the command. The type of parameters and the ranges of the settings will depend on the command that is selected.

④ **EXECUTE button**

Move the cursor to this button and press the [ENTER] key to execute the editing command.

2 Move the cursor to the edit command field, use the [DATA/JOG] dial or the [INC]/[DEC] keys to select an editing command, and press the [ENTER] key.

The displayed content of the page will depend on the edit command you selected.



### ■ Select the track(s) to edit

After you choose an editing command, the next step is to specify the track(s) that will be edited.

- To select the track for editing, move the cursor to the TR (Track) field in the left of the screen, and use the [DATA/JOG] dial or [INC]/[DEC] keys.**

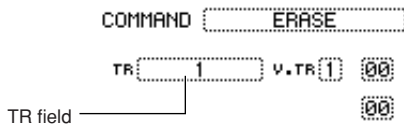

In the TR field you can select the following types of data.

- **1-24** ..... An audio track
- **1&2-23&24** ..... A pair of adjacent odd-numbered/ even-numbered audio tracks
- **ST** ..... The stereo track
- **ALL** ..... Audio tracks 1-24
- **CLIP** ..... Sound clip

- Select the virtual track that you want to edit.**

If you selected an audio track (1-24, 1&2-23&24, ST) in step 3, the V.TR field will appear at the right, allowing you to select the virtual track number. Move the cursor to this field and select a virtual track number 1-8.

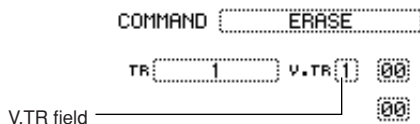

- For some commands, you will need to specify both source and destination tracks.

### ■ Specify the editing region

For most commands, you will need to set the Start (the beginning of the edited region) and End (the end of the edited region) parameters to specify the region that will be affected by the command.

- To specify the beginning of the region to be edited, move the cursor to the desired digit of the Start field, and use the [DATA/JOG] dial or [INC]/[DEC] keys.**

The Start/End parameters are displayed at the right of the TR field.

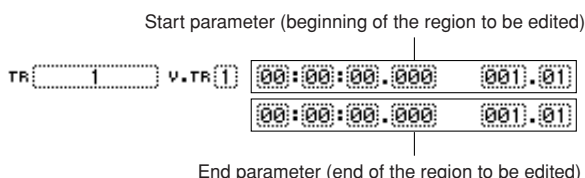

You can set the Start/End parameters in terms of the counter display format (the value at the left) or in units of measures/beats (the value at the right). Move the cursor to the digit that you want to change, and use the [DATA/JOG] dial or [INC]/[DEC] keys to set the value.



- If you selected the sound clip as the object for editing, the region from the start point of the sound clip to its end point will always be the object of editing. If necessary, you should specify the start point and end point of the sound clip beforehand.

- To specify the end of the region to be edited, move the cursor to the desired digit of the End field, and use the [DATA/JOG] dial or [INC]/[DEC] keys.**



- If you move the cursor to the Start or End parameter and press the [ENTER] key, the current counter location will be input. Alternatively, you can recall a locate point or marker to move to that location in the song, and then press the [ENTER] key to input that location as the value of the Start or End parameter.



- For some commands, you will also need to specify a location in the editing-destination track. In the same way as described above, move the cursor to the counter display format field or the measure/beat field, and specify the location.

### ■ Execute the command

When you have finished setting parameters, execute the command.

- Move the cursor to the EXECUTE button, and press the [ENTER] key.**

A popup window will ask you to confirm the operation.



- Move the cursor to the OK button to execute the command, or move the cursor to the CANCEL button to cancel without executing. Then press the [ENTER] key.**



- Even after you press the [ENTER] key to execute the command, you can press the [UNDO/REDO] key to return to the state prior to executing the command. You can use this function to compare the original data with the results produced by executing the command.



- If as a result of executing a command, a track no longer contains any recorded data, the name of that track will change to "NO REC-".

# List of editing command

This section lists all the commands that are provided in the EDIT screen, and explains their parameters.

## ERASE

Erases the data in the specified region (between Start and End) of the specified track(s).

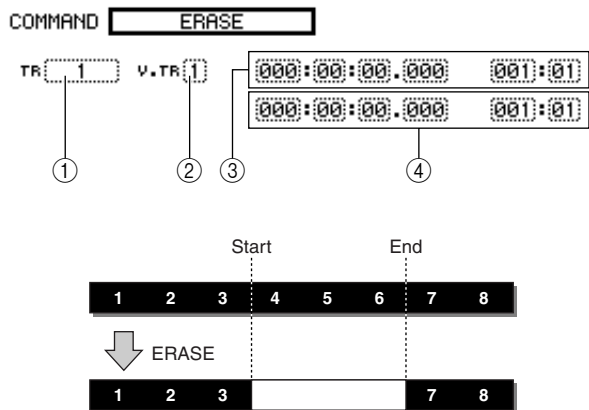

### Parameter list

Parameter	Range	Explanation
① TR	1-24	A single audio track
	1&2-23&24	A pair of adjacent odd-numbered/ even-numbered audio tracks
	ST	The stereo track
	ALL	Tracks 1-24
② V.TR *1	1-8	Virtual track number
③ Start	Specify a point	Beginning of the edited region
④ End	Specify a point	End of the edited region

\*1. V.TR can be selected only if TR=1-24, 1&2-23&24, or ST.

## DELETE

Deletes the data from the specified region of the specified track(s).

This command is similar to ERASE, but differs in that the data that follows the specified region will move forward to fill the gap.

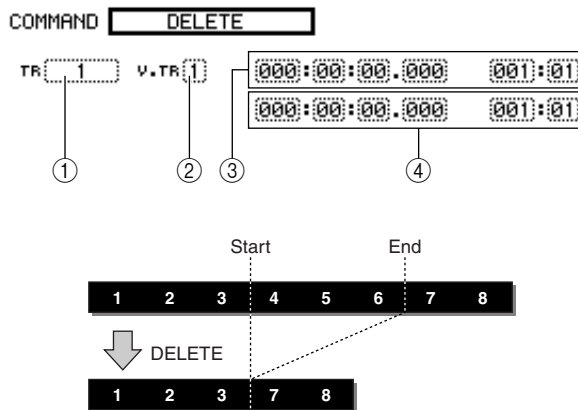

### Parameter list

The parameters are the same as for the ERASE command.

## INSERT

Inserts blank space into the specified region. Data following the location of the Start parameter will be moved backward to make room.

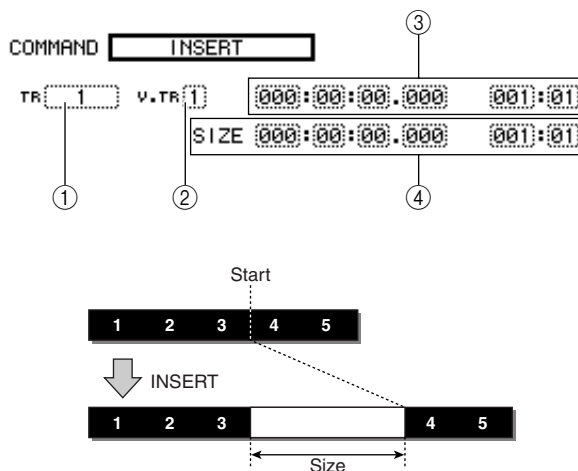

### Parameter list

The parameters are the same as for the ERASE command. However instead of ④ End, use ④ Size to specify the region that will be inserted.

15 Track operations and editing

## COPY

Copies the specified region of data to the specified location of the specified track.

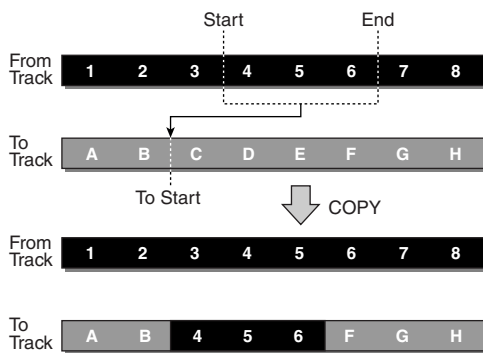
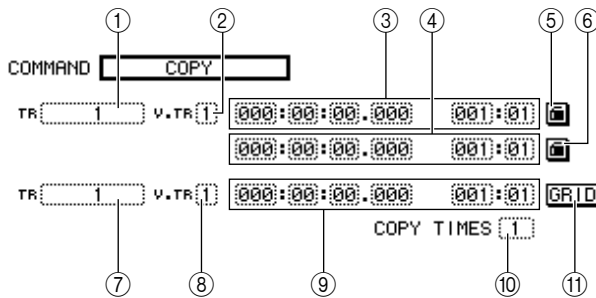

### NOTE

- If you set From TR to ALL (INS), the copy-destination track will be moved backward by the size of the copied region. Note that this may cause the bar lines specified by the tempo map to change their location relative to the audio data.
- If you set From TR to other than ALL (INS), the copy-destination track will be overwritten, and the data that follows the copied region will not be moved backward.

### HINT

- Audio data recorded in the sound clip (→ p. 43) can be copied to an audio track by using the COPY command.
- The metronome of the sound clip is independent of the song tempo. If you record into the sound clip with the intention of copying it to an audio track, you should match the tempo ahead of time.

## Parameter list

Parameter	Range	Explanation
① From TR	1-24	A single audio track
	1&2-23&24	A pair of adjacent odd-numbered/even-numbered audio tracks
	ST	The stereo track
	ALL (OVER)	Tracks 1-24 (overwrite onto the copy-destination)
	ALL (INS)	Tracks 1-24 (insert into the copy-destination)
	CLIP	Sound clip contents (the range is specified by CLIP)
② From V.TR <sup>*1</sup>	1-8	Copy-source virtual track number
③ From Start	Specify a point	Copy-source starting location
④ From End	Specify a point	Copy-source ending location
⑤ Start Measure Lock <sup>*2</sup>	On/off (indicated by "lock" icon)	Switch the measure lock function for From Start/From End
⑥ End Measure Lock <sup>*2</sup>		
⑦ To TR <sup>*3</sup>	1-24	A single audio track
	1&2-23&24	A pair of adjacent odd-numbered/even-numbered audio tracks
	ST	The stereo track
⑧ To V.TR <sup>*1</sup>	1-8	Copy-destination virtual track
⑨ To Start	Specify a point	Copy-destination starting location
⑩ COPY TIMES	1-99	Number of copies
⑪ GRID <sup>*4</sup>	ON/OFF (indicated by highlighted GRID text when on)	Switch the grid function

\*1. V.TR can be selected only if From TR=1-24, 1&2-23&24, or ST.

\*2. Measure lock function (⑤ Start Measure Lock, ⑥ End Measure Lock)

Measure Lock allows a measure/beat to be specified within a region to be copied so that it aligns with the specified measure/beat in the copy destination.

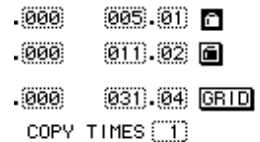

For example, in a situation in which you have an abstract or rubato segment before the in-tempo performance begins, you can "Measure Lock" the beginning of the in-tempo segment so that it is copied to the appropriate location in the destination.

To use the measure lock function, move the cursor to the measure display field of From Start or From End, specify the measure/beat location that will be the reference point for the matching, and press the [ENTER] key. A "lock" icon will appear beside the value that you specified, and the measure lock function will be turned on for From Start or From End. (This can be turned on for either Start or End, not both.)

While the measure lock function is on, the value of that measure display format setting will be fixed, and cannot be modified. In this state if you use the counter display format field to specify the From Start and From End locations, and execute the copy, the location you specified in the measure display format field will be aligned with the copy-destination To Start setting.

● When measure lock = on

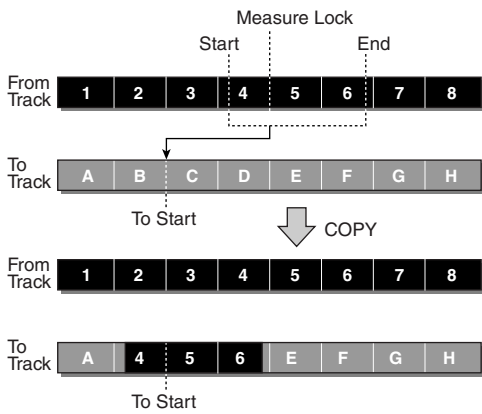

- \*3. The possible choices for ⑦ To TR (copy-destination track) will depend on your selection for ① From TR (copy-source track).  
 If ① From TR is a single audio track 1–24, you will be able to select only a single audio track 1–24.  
 If ① From TR is CLIP, ST, 1&2–23&24 (a pair of adjacent audio tracks), you will be able to select only ST or 1&2–23&24 (a pair of adjacent audio tracks).  
 If ① From TR is ALL OVER or ALL INS, you cannot select TO TR.
- \*4. Grid function (⑩ GRID)  
 When this function is on, the To Start location cannot be specified in counter-display format; it can be specified only in measure/beat units.  
 By using the Grid function in conjunction with the Measure Lock function, you can easily copy measure/beat-length segments of data whose divisions do not fall precisely on the measure or beat.

## MOVE

Moves the specified region of data to the specified location of the specified track. This is similar to COPY, but differs in that the move-source data will be deleted.

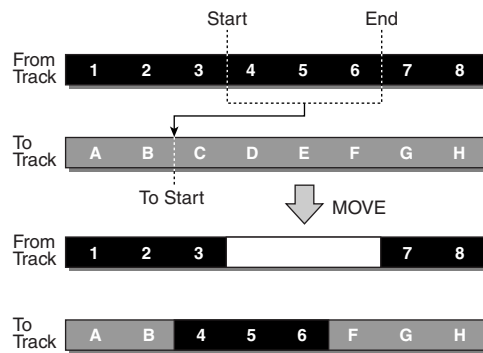
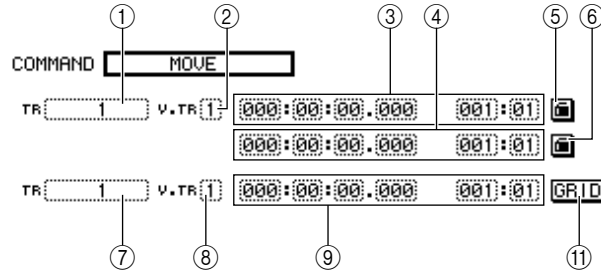

### ■ Parameter list

The parameters are the same as for the COPY command. However, you cannot select CLIP for ① From TR. Also, there is no ⑩ COPY TIMES setting.

## EXCHANGE

Exchanges data between the specified tracks.

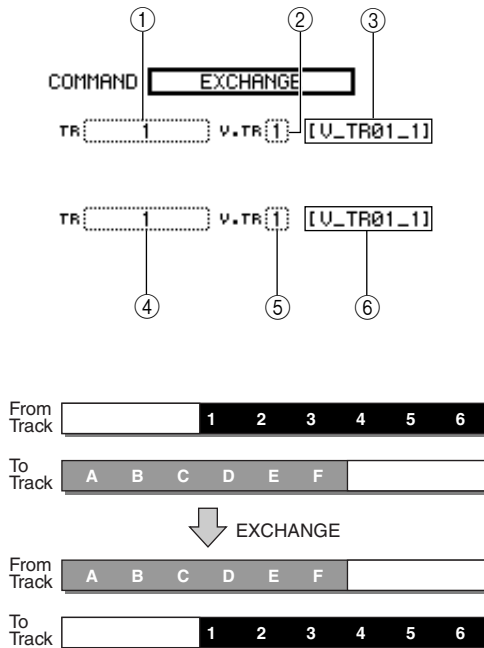

### Parameter list

Parameter	Range	Explanation
① From TR	1-24	A single audio track
	1&2-23&24	A pair of adjacent odd-numbered/ even-numbered audio tracks
	ST	The stereo track
② From V.TR	1-8	Exchange-source virtual track number
③ Name	Up to eight alphanumeric characters	Exchange-source virtual track name (display only)
④ To TR *1	1-24	A single audio track
	1&2-23&24	A pair of adjacent odd-numbered/ even-numbered audio tracks
⑤ To V.TR	1-8	Exchange-destination virtual track number
⑥ Name	Up to eight alphanumeric characters	Exchange-destination virtual track name (display only)

\*1. The items that you can select in ④ To TR (copy-destination track) will depend on the ① From TR (copy-source track) setting.  
If ① From TR is a single audio track 1-24, you can select only a single audio track 1-24.  
If ① From TR is ST or 1&2-23&24 (a pair of adjacent audio tracks), you can select only 1&2-23&24 (a pair of adjacent audio tracks).

#### NOTE

- The track names will not be exchanged.

## TIME COMP (Time Compression/Expansion)

Adjusts the length of the specified region of an audio track, without changing the pitch.

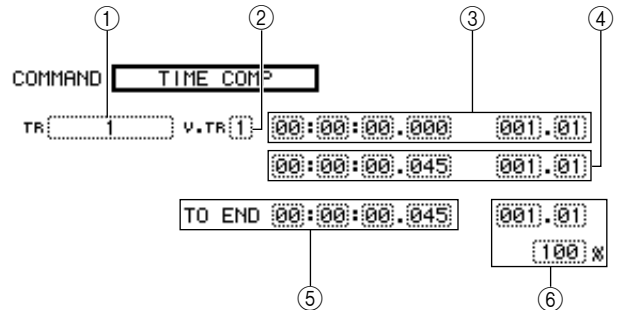

### ● If you set Ratio = 50%

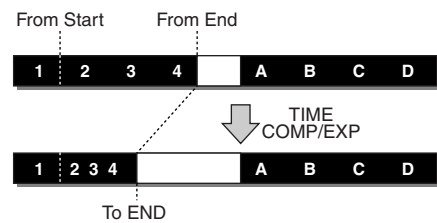

### ● If you set Ratio = 200%

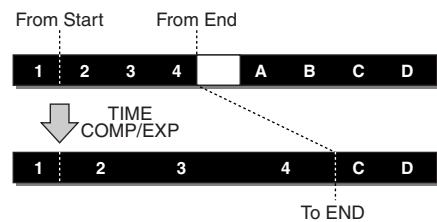

### Parameter list

Parameter	Range	Explanation
① From TR	1-24	A single audio track
	1&2-23&24	A pair of adjacent odd-numbered/ even-numbered audio tracks
	ST	The stereo track
② From V.TR	1-8	Virtual track number
③ From Start	Specify a point	Beginning of the edited region
④ From End	Specify a point	End of the edited region
⑤ TO END	Specify a point	Specify the length to which the selected region will be com- pressed or expanded
⑥ To Ratio	50-200%	Specify the percentage by which the selected region will be com- pressed or expanded

#### NOTE

- TO END and To Ratio are linked, so that editing one field will cause the other field to change.
- You cannot set TO END or To Ratio to a value that would cause the ratio to exceed 50-200 percent.
- From Start value and From End value must be at least 45 msec apart. These cannot be set to a shorter interval.

## PITCH (Pitch Change)

Adjusts the pitch of the specified region of an audio track, without changing the length.

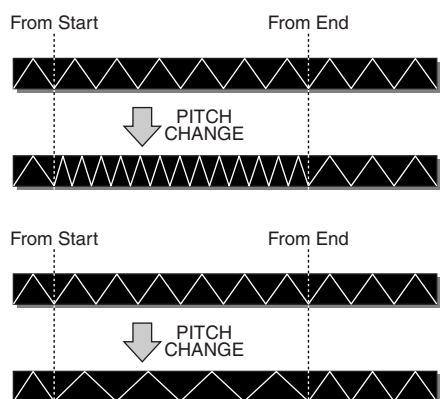
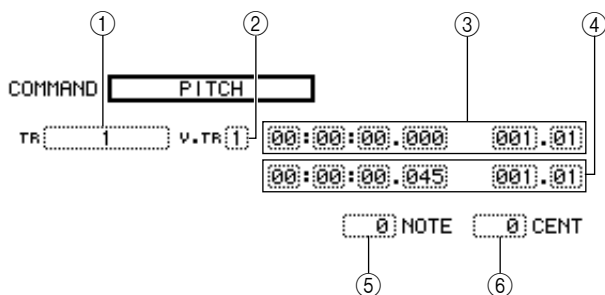

### Parameter list

Parameter	Range	Explanation
① From TR	1-24	A single audio track
	1&2-23&24	A pair of adjacent odd-numbered/ even-numbered audio tracks
	ST	The stereo track
② From V.TR	1-8	Virtual track number
③ From Start	Specify a point	Beginning of the edited region
④ From End	Specify a point	End of the edited region
⑤ NOTE	-12 to +12 semitones	Specify the amount of pitch change in semitone units
⑥ CENT	-50 to +50 cents	Specify the amount of pitch change in one-cent units (1/100th of a semitone)

## IMPORT CD AUDIO

Imports audio data (CD-DA) from CD-R/RW media in the CD-RW drive into an audio track of the AW2400. For details on the parameters and operation of the IMPORT CD AUDIO command, refer to “Importing from the CD-RW drive” (→ p. 143).

## IMPORT CD WAV

Imports a WAV file from CD-R/RW media in the CD-RW drive into an audio track of the AW2400. For details on the parameters and operation of the IMPORT CD WAV command, refer to “Importing from the CD-RW drive” (→ p. 143).

## IMPORT USB WAV

Imports a WAV file copied from a computer into the “Transport” folder into an audio track of the AW2400. For details on the parameters and operation of the IMPORT USB WAV command, refer to “Importing Copied WAV Files From the Computer” (→ p. 234).

## IMPORT TRACK

Imports audio data recorded in another song into an audio track of the current song. For details on the parameters and operation of the IMPORT TRACK command, refer to “Importing audio data from another song” (→ p. 145).

## EXPORT

Exports the specified region of an audio track to a WAV file in the “Transport” folder. For details on the parameters and operation of the EXPORT command, refer to “Copying Exported WAV Files To the Computer” (→ p. 233).

## MERGE

Audio playback performance can be improved by using this command to merge a number of separate regions (sections of audio data created in separate recording passes) in a specified track into one continuous region. The merge command creates a continuous region from the beginning of the track to the end of the last region on the track, and sections of the track that contained no regions are replaced with audio silence.

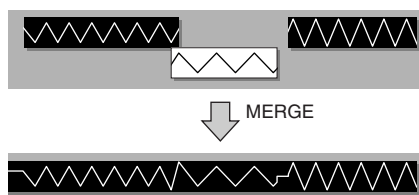
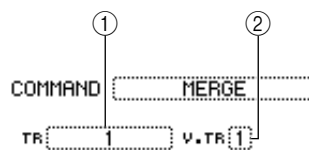

### Parameter list

Parameter	Range	Explanation
① From TR	1-24	A single audio track
	1&2-23&24	A pair of adjacent odd-numbered/ even-numbered audio tracks
② From V.TR	1-8	Virtual track number

15 Track operations and editing

# Importing audio data/WAV files

This section explains how to load (import) audio data or WAV files from the CD-RW drive or from the desired track of a different song.

## Importing from the CD-RW drive

CD audio data (CD-DA) or a WAV file from a CD-ROM or CD-R can be imported (loaded) into an AW2400 audio track. After being imported, this data can be handled in the same way as any recorded audio track.

- 1 Call the **UTILITY** screen Preference page by either pressing the Work Navigate section [UTILITY] key as many times as necessary, or by pressing the [F2] key after pressing the [UTILITY] key.

Immediately after the AW2400 is powered-on, it will be set to prohibit digital recording from an external source or importing from a CD. Before you can import, you will need to disable this prohibition in the UTILITY screen Preference page.

- 2 Move the cursor to the **CD/DAT DIGITAL REC** button, and press the [ENTER] key.

A message will ask you to confirm that you will observe the applicable copyright laws.



- 3 Carefully read "Copyright Notice" (→ p. 7), and if you accept these terms, move the cursor to the **OK** button and press the [ENTER] key.

The button display will change from DISABLE to ENABLE, and digital recording and importing from a CD will be enabled.



• The CD/DAT DIGITAL REC button will return to the DISABLE setting each time you turn on the power.

- 4 Insert a CD into the CD-RW drive.

You can import data from the following types of media.

- **Audio data (CD-DA)**
  - Audio CD
  - CD-Extra (only the first session of CD-DA)
  - Mixed Mode CD (only CD-DA data of the second and later tracks)

- **WAV files**

- ISO9660 Level 1 format CD-ROM, CD-R, CD-RW\*
- Mixed Mode CD
  - \* The directory name and file name cannot use characters other than uppercase alphanumeric characters and the "\_" (underscore) character.

- 5 Call the **EDIT** screen Edit page by either pressing the Work Navigate section [EDIT] key as many times as necessary, or by pressing the [F1] key after pressing the [EDIT] key.

- 6 Move the cursor to the editing command field, use the [DATA/JOG] dial or [INC]/[DEC] keys to select the desired editing command.

Select "IMPORT CD AUDIO" if the import-source is an audio CD or CD-Extra, or select "IMPORT CD WAV" if the import-source is a WAV file.

- 7 Press the [ENTER] key to confirm the edit command.

The READ CD INFO button will appear in the center of the display.

The following illustration shows the screen when you've selected IMPORT CD AUDIO as the edit command.

COMMAND **IMPORT CD AUDIO**



• If you choose a song whose sample rate is 48 kHz in the IMPORT CD AUDIO command, a message of "Current Song is 48kHz Fs Type." appears, and you won't be able to load the audio data.

- 8 Move the cursor to the **READ CD INFO** button and press the [ENTER] key.

The display will indicate "Read CD Info...", and information will be read from the CD inserted in the CD-RW drive.

Depending on the import-source data, the screen will change as follows.



• If the CD/DAT DIGITAL REC button is set to "DISABLE" in the UTILITY screen Preference page, the display will indicate "CD Import Prohibited!", and you won't be able to import from the CD. If this occurs, refer to steps 1–3 and check your settings once again.

● When using IMPORT CD AUDIO

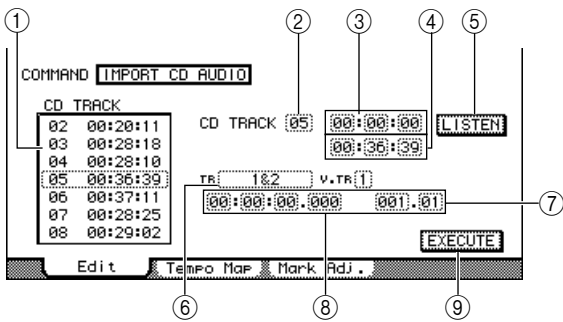

① **Track list**

This shows each track of the audio CD inserted in the CD-RW drive, in units of minutes/seconds/frames (1/75 second). Move the cursor to the list, and use the [DATA/JOG] dial or the [INC]/[DEC] keys to specify the number of the audio track you want to import. Operations in the track list are linked with the From CD TRACK field.

② **From CD TRACK**

Specifies the audio track number (01–99) of the import-source CD.

③ **From Start**

Specifies the beginning of the data that will be imported, in minutes/seconds/frames (1/75 second).

④ **From End**

Specifies the end of the data that will be imported, in minutes/seconds/frames (1/75 second).



• The “frames” referred to here are the minimum time-axis units used in CD-DA. Do not confuse them with the frames used in MTC or SMPTE.

⑤ **LISTEN button**

You can move the cursor to this button and press the [ENTER] key to repeatedly hear the currently selected region of the CD-DA.

⑥ **To TR**

Selects the track number into which the data will be imported. If the import-source is an audio CD or a stereo WAV file, you will only be able to select a pair of tracks 1&2–23&24.

⑦ **To V.TR**

Selects the virtual track number (1–8) into which the data will be imported.

⑧ **To Start**

Specifies the starting location (in counter-display format) of the import-destination to which the data will be imported.

⑨ **EXECUTE button**

Executes the import operation.

● When using IMPORT CD WAV

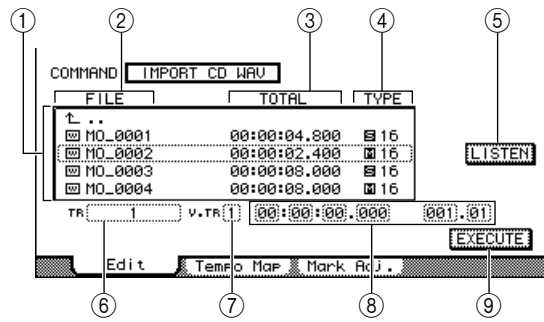

① **File list**

This shows the WAV files and folders (directories) stored on the CD. Move the cursor to the list, and use the [DATA/JOG] dial or the [INC]/[DEC] keys to specify the WAV file that you want to import.

② **FILE**

This indicates the name of the WAV file or directory. The displayed icons have the following meaning.

- ..... Indicates a WAV file.
- ..... Indicates a folder in the same level. You can select this icon and press the [ENTER] key to move down one level.
- ..... You can select this icon and press the [ENTER] key to move up one level.

③ **TOTAL**

Indicates the playback length (in units of hours/minutes/seconds/milliseconds) of the WAV file. This field is for display only, and cannot be changed.

④ **TYPE**

Indicates whether the WAV file is monaural () or stereo (). The numerical value at the right indicates the bit depth of the WAV file. This field is for display only, and cannot be changed.

⑤ **LISTEN/ENTER/UP button**

If a WAV file is selected, the LISTEN button will be displayed, allowing you to hear the WAV file repeatedly. If a folder is selected, the ENTER button will be displayed, allowing you to move into that folder. If the button is selected, the UP button will be displayed, allowing you to move to the next higher folder.



• You cannot audition WAV files whose bit depth or sample rate differs from the current song.

⑥ **To TR**

Selects the track number into which the data will be imported. If the import-source is a stereo WAV file, you will only be able to select a pair of tracks 1&2–23&24.

⑦ **To V.TR**

⑧ **To Start**

⑨ **EXECUTE button**

These are the same as for IMPORT CD AUDIO.



**NOTE**

- In the case of a Mixed Mode CD, the edit command you use will depend on the data you're importing. Use **IMPORT CD AUDIO** to import audio data (CD-DA), or use **IMPORT CD WAV** to import a WAV file.
- You cannot import a WAV file whose bit depth or sample rate differs from the current song.
- When the import source is an audio CD or CD Extra disc and the song is 24-bit, the audio data will be automatically converted to 24-bit format during the import operation.
- When you move the cursor to the **LISTEN** button and press the **[ENTER]** key, there will be a slight time lag while the data is read from the CD before you hear it.

**9 Move the cursor to the track list (file list), and use the [DATA/JOG] dial or the [INC]/[DEC] keys to select the track or WAV file that you want to import.**

If you're using **IMPORT CD WAV**, and the  is located at the line enclosed by the dotted line, you can press the **[ENTER]** key to move to the next lower level.

To move to the next higher level, move the cursor to the  and press the **[ENTER]** key.

**10 If you're using IMPORT CD AUDIO, use From Start/From End to specify the region that will be imported.**

**11 Use the To TR, To V.TR, and To Start fields to specify the track number, virtual track number, and starting location into which the data will be imported.**

**NOTE**

- If the import-destination contains data, it will be overwritten. Be careful not to overwrite important data by accident.

**12 When you have finished making settings, move the cursor to the EXECUTE button and press the [ENTER] key.**

A popup window will ask you to confirm the operation.



**13 To execute the import operation, move the cursor to the OK button and press the [ENTER] key.**

Importing will begin. If you move the cursor to the **CANCEL** button and press the **[ENTER]** key, importing will be cancelled.

## Importing audio data from another song

Here's how you can import audio data from another song saved on the AW2400's hard disk.

**1 Call the EDIT screen Edit page by either pressing the Work Navigate section [EDIT] key as many times as necessary, or by pressing the [F1] key after pressing the [EDIT] key.**

**2 Move the cursor to the edit command field, and use the [DATA/JOG] dial or the [INC]/[DEC] keys to select IMPORT TRACK.**

**3 Press the [ENTER] key to conform your choice of edit command.**

The screen will change as follows.

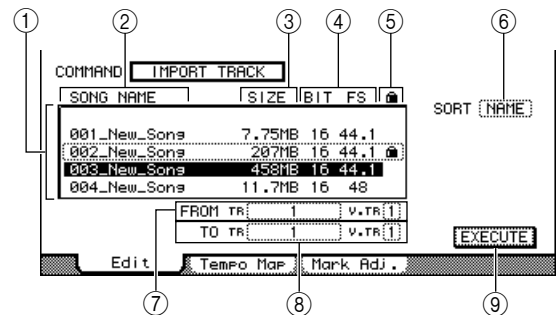

**① Song List**

This area lists the songs that are saved on the AW2400's internal hard disk. In this list, select the song that contains the track you want to import.

**② Song name**

**③ Song size**

**④ Song Bit Depth/Sampling Frequency**

**⑤ Song Protect Status**

**⑥ SORT**

Move the cursor to this box, and use the **[DATA/JOG]** dial or the **[INC]/[DEC]** keys to choose the order in which you want the songs in the list to appear.

- **NAME**..... Song names in alphabetical order.
- **SIZE** ..... Song size, from largest to smallest.
- **OLD**..... The order in which the songs were saved, from newest to oldest.

**⑦ From TR/From V.TR**

Here you can select the desired track number (1–24, ST) and virtual track number (1–8) of the import-source song.

⑧ **To TR/To V.TR**

Here you can select the track number (1–24, ST) and virtual track number (1–8) of the import-destination song (the current song).

If From TR is 1–24, you cannot select ST in the To TR field. If From TR is ST, only ST can be selected.

⑨ **EXECUTE button**

Executes the import operation.

**4 Move the cursor to the song list, and use the [DATA/JOG] dial or the [INC]/[DEC] keys to select the song that includes the track you want to import.**

**NOTE**

- You cannot import from a song whose bit depth or sample rate differs from the current song.

**5 Move the cursor to From TR/From V.TR, and use the [DATA/JOG] dial or the [INC]/[DEC] keys to select the track number and virtual track number that you want to import.**

The track number and virtual track number of the song you selected in step 4 will be assigned as the import-source.

**6 Move the cursor to To TR/To V.TR, and use the [DATA/JOG] dial or the [INC]/[DEC] keys to select the track number and virtual track number of the desired import-destination.**

**NOTE**

- If the import-destination contains data, it will be overwritten. Be careful that you don't accidentally overwrite important data.

**7 When you've finished making settings, move the cursor to the EXECUTE button and press the [ENTER] key.**

A popup window will ask you to confirm the operation.



**8 To execute the Import operation, move the cursor to the OK button and press the [ENTER] key.**

Importing will begin. If you decide to cancel the Import operation, move the cursor to the CANCEL button and press the [ENTER] key.

# Pan, EQ, and Dynamics Processing

In this section we'll cover operation of the channel pan (or balance), equalizer, and dynamics processing controls.

## Pan Control

These controls adjust the “pan” position (or balance on stereo channels) of the input, effect return, track, and stereo output channels. Pan can be adjusted either by using the knobs in the PAN/EQ screen, or by using the physical pan control in the Selected Channel section.

### ■ Pan Control via the PAN/EQ Screen

Pan operation via the dedicated display screen.

**1** Press the Selected Channel section [PAN/EQ] key so that its indicator lights, then press Selected Channel knob 1 to call the PAN/EQ screen.

**2** Press the Display section [F1] (Input/RTN page) or [F2] (Track page) key.

The pan operations available via each page are as follows:

#### ● PAN/EQ Screen Input/RTN Page

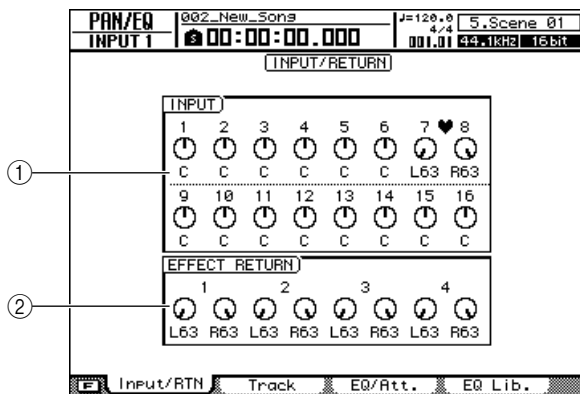

- ① **INPUT field**  
Pan controls for input channels 1–16.
- ② **EFFECT RETURN field**  
Pan controls for effect return channels 1–4.

#### ● PAN/EQ Screen Track Page

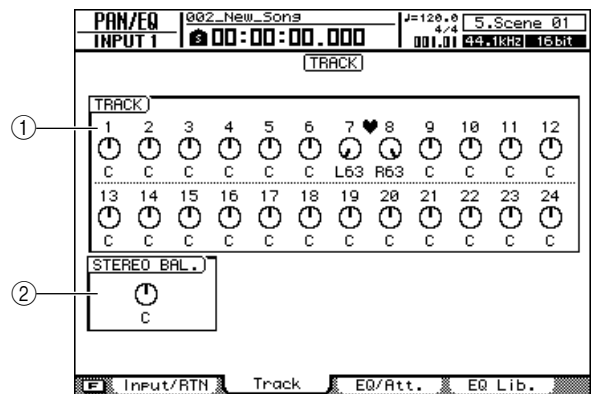

- ① **TRACK field**  
Pan controls for track channels 1–24.
- ② **STEREO BAL. field**  
Balance control for the stereo output channel.



You can switch back and forth between the Input and Track pages while the PAN/EQ screen is showing by pressing the [PAN/EQ] key.

**3** Move the cursor to a knob and use the [DATA/JOG] dial or the [INC]/[DEC] keys to set the pan as required.

The pan value range is from L63 (full left)–C (center)–R63 (full right).



- Knobs can also be selected via the Layer section keys, [INPUT SEL] keys, [SEL] keys, and [STEREO SEL] key.
- You can alternately select the left and right effect return channels by repeatedly pressing the effect return channel [SEL] key.
- The pan “C” (center) setting can be instantly recalled by pressing the [ENTER] key after moving the cursor to a pan knob.

**4 The panning for paired channels can be adjusted in three different ways: hold the Display section [SHIFT] key while pressing the [F1], [F2], or [F3] key.**

• **[F1] key — INDIVIDUAL**

The pan positions of the paired channels can be adjusted individually.



• **[F2] key — GANG**

The pan positions of the paired channels are adjusted simultaneously in the same direction, maintaining the relative positions of each channel.

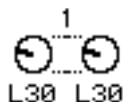

• **[F3] key — INV.GANG**

The pan positions of the paired channels are adjusted simultaneously in opposite directions.



• This operation can be accessed via both the Input/RTN and Track pages, and affects both pages.

**■ Pan Control via the Selected Channel section**

Adjusting pan via Selected Channel section knob 1.

**1 Use the Layer section, [INPUT SEL], [SEL], and [STEREO SEL] keys to select the channel for which pan is to be controlled.**

**2 Press the Selected Channel section [PAN/EQ] key so that its indicator lights.**

With the default settings the PAN/EQ screen will appear automatically. The display will not change if the UTILITY screen Preference page AUTO DISPLAY button is set to OFF.

**3 Rotate Selected Channel knob 1 to adjust the pan of the channel selected in step 1.**

If the UTILITY screen Preference page AUTO DISPLAY button is set to OFF, a popup window showing the current pan setting will appear while knob 1 is being operated.

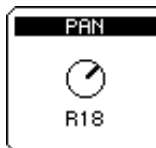

# 4-band EQ

The AW2400 provides 4-band parametric equalization (LOW, LO-MID, HI-MID, HIGH) on the channels listed below.

- Input
- Track
- Bus Master
- Effect Return
- Stereo Output
- AUX Send Master

The LO-MID and HI-MID bands provide peaking EQ control, while the LOW and HIGH bands can be used in shelving, peaking or high-pass filter (LOW)/low-pass filter (HIGH) mode. EQ can be adjusted either by calling the PAN/EQ screen and using the graphic knobs, or by using the physical controllers in the Selected Channel section.

## ■ EQ Control via the PAN/EQ Screen

Adjusting equalization via the PAN/EQ screen.

- 1** Use the Layer section, [INPUT SEL], [SEL], and [STEREO SEL] keys to select the channel for which EQ is to be controlled.
- 2** Press the Selected Channel section [PAN/EQ] key so that its indicator lights. Press Selected Channel knob 2, 3, or 4 and the PAN/EQ screen will appear.
- 3** Press the Display section [F3] key, or press the [PAN/EQ] key as many times as necessary until the EQ/Att. page appears.

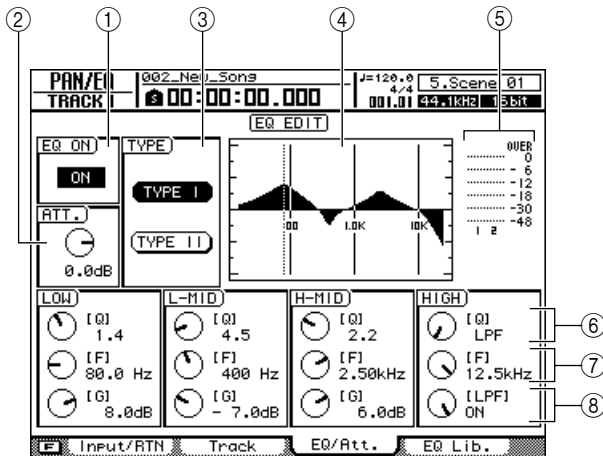

The EQ/Att. page includes the following items.

- ① EQ ON/OFF button**  
Switches the EQ on/off.
  - ② ATT. (Attenuation) knob**  
Attenuates the signal immediately before the EQ stage over a range of -96 to 12.0 dB. This is used mainly to prevent the signal from clipping when you use the EQ to boost a specific frequency region.
  - ③ TYPE field**  
Selects the EQ algorithm type. When the TYPE I button is on the same EQ algorithm that was used in the 02R is selected. The TYPE II button selects the latest EQ algorithm which provides minimum inter-band interference. TYPE II can only be selected for the track channels, stereo output channels, and bus master channels.
  - ④ Response curve**  
Graphically indicates the approximate response of the EQ.
  - ⑤ Output meter**  
Indicates the level of the signal after it has passed through the EQ.
  - ⑥ Q knobs**  
Specify the Q (steepness) at which each band (HIGH, HI-MID, LO-MID, LOW) will be boosted or cut. The range is 10–0.10, and higher settings will produce a steeper curve.
  - ⑦ F (Frequency) knobs**  
Specify the center frequency of the boost/cut, over a range of 21.2 Hz–20.0 kHz.
  - ⑧ G (Gain) knobs**  
Specify the amount of boost/cut, over a range of -18.0 dB to +18.0 dB.
- 4** To switch the EQ on, move the cursor to the EQ ON/OFF button and press the [ENTER] key.
  - 5** When working on a track channel, stereo output channel, or bus master channel, the EQ type can be selected via the TYPE field.

- 6** Move the cursor to the parameter that you want to edit, and use the [DATA/JOG] dial or the [INC]/[DEC] keys to adjust the value.

## HINT

- If you press the [F1] (FLAT) key while holding the [SHIFT] key from the PAN/EQ screen EQ/Att. page, all G knobs for the currently selected channel will be set to 0.0dB (or OFF).

- 7** To switch the LOW band type, move the cursor to the LOW band Q knob and continue turning the [DATA/JOG] dial toward the left or right.

If you continue turning the Q knob toward the right, the Q knob value will indicate “L.SHELF,” and will switch to the shelving type.

If you turn the Q knob toward the left, the Q knob value field will change to a numerical value, and will switch to the same boost/cut type as the HI-MID and LO-MID bands.

If you continue turning the Q knob toward the left, the Q knob value field will indicate “HPF,” and the LOW band will function as a high-pass filter. If “HPF” is selected, you can use the LOW band G knob to switch the high-pass filter on/off.

- 8** To switch the HIGH band type, move the cursor to the HIGH band Q knob and continue turning the [DATA/JOG] dial toward the left or right.

If you continue turning the Q knob toward the right, the Q knob value will indicate “H.SHELF,” and will switch to the shelving type.

If you turn the Q knob toward the left, the Q knob value field will change to a numerical value, and will switch to the same boost/cut type as the HI-MID and LO-MID bands.

If you continue turning the Q knob toward the left, the Q knob value field will indicate “LPF,” and the HIGH band will function as a low-pass filter. If “LPF” is selected, you can use the HIGH band G knob to switch the low-pass filter on/off.

## HINT

- EQ settings can also be recalled from the EQ library, or your own settings can be saved for later recall. See “EQ/Dynamics Processor Library Operation” on page 154 for details.
- If boost in a particular band results clipping on the meters, use the ATT. knob to reduce the signal level.
- Selected Channel knobs 2, 3, and 4 also function while the PAN/EQ screen EQ/Att. page is showing.

## EQ Control via the Selected Channel section

Using Selected Channel section knobs 2–4 to adjust EQ.

- 1** Use the Layer section, [INPUT SEL], [SEL], and [STEREO SEL] keys to select the channel for which EQ is to be controlled.
- 2** Press the Selected Channel section [LOW], [LO-MID], [HI-MID], or [HIGH] key, according to the band you want to control.

The selected key’s indicator will light, as will the [PAN/EQ] key.

With the default settings the PAN/EQ screen will appear automatically. The display will not change if the UTILITY screen Preference page AUTO DISPLAY button is set to OFF.

- 3** Rotate Selected Channel knobs 2–4.

The parameters for the channels selected in step 1 and the band selected in step 2 will change accordingly.

The knobs control the following parameters.

Selected Channel knobs 2–4	2	3	4
Parameters	Q	Frequency (center frequency)	Gain

If the UTILITY screen Preference page AUTO DISPLAY button is set to OFF, a popup window showing the current EQ settings will appear while Selected Channel knobs 2–4 are being operated.



# Dynamics Processing

The AW2400 provides gate and compressor facilities for dynamics processing. In this section operation of the gate and compressor will be explained individually.

## Using the Gates

The gate attenuates signals below a specified threshold level, and can be used to eliminate noise in silent sections of a track. Gates are only provided on input channels.

- 1 Use the Layer section, [INPUT SEL] and [SEL] keys to select the channel to which the gate is to be applied.
- 2 Press the Selected Channel section [DYN] key so that its indicator lights, then press Selected Channel knob 1, 2, 3, or 4.  
The DYNAMICS screen will appear.
- 3 Press the Display section [F1] key, or press the [DYN] key as many times as necessary until the Gate Edit page appears.

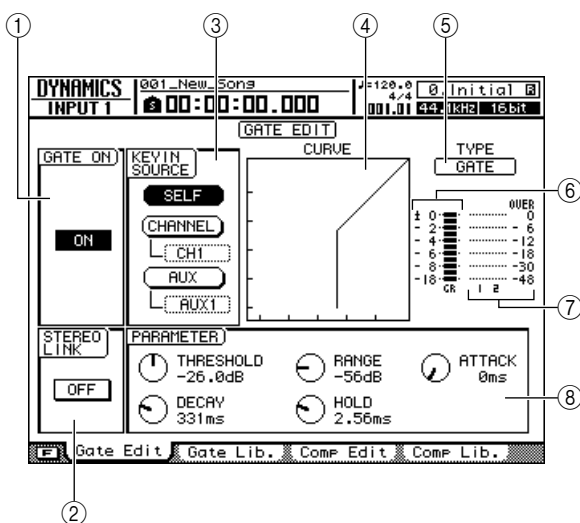

The Gate Edit Page includes the following items.

- ① **GATE ON/OFF button**  
Switches the gate on/off.
- ② **STEREO LINK button**  
Turning this button on links gate operation for paired channels.

**NOTE**

- Gate operation can only be linked for adjacent odd and even numbered channels that can be paired.

- ③ **KEYIN SOURCE field**  
Selects one of the following trigger sources for the gate.
  - **SELF button ...** Selects the signal from the currently selected channel.
  - **CHANNEL button** ..... Selects the signal from the channel specified in the box below the button (CH1–CH16). After selecting a channel in the channel box, press the [ENTER] key to confirm the selection.
  - **AUX button.....** Selects the signal from the AUX send specified in the box below the button (AUX1–AUX4). After selecting an AUX send in the box, press the [ENTER] key to confirm the selection.

④ **Response curve**  
This graph indicates the approximate response of the gate settings. The horizontal axis of the graph is the input level, and the vertical axis is the output level.

⑤ **TYPE**  
Indicates the currently selected gate type. The displayed indication has the following meaning.

- **GATE.....** Gate
- **DUCKING.....** Ducking

**HINT**

- You cannot change the gate type via this page. If you want to use a different gate type, you must recall a library setting that uses the desired type. For details on recalling library gate settings, refer to "EQ/Dynamics Processor Library Operation" on page 154.

⑥ **GR (Gain Reduction)**  
Indicates the amount of gain reduction produced by the gate processor over a range of -18 dB to 0 dB.

⑦ **Output meter**  
Indicates the level of the signal after it has passed through the gate processor.

⑧ **PARAMETER**  
Here you can edit the parameters of the gate processor. The type of parameters and their ranges will differ depending on the gate type. For details on the types of parameter and their function, refer to the appendix.

**4** Move the cursor to the **GATE ON/OFF** button and press the **[ENTER]** key to turn the gate on.



- Pressing the **[F1]** key while holding the Display section **[SHIFT]** key has the same effect as the **GATE ON/OFF** button.

**5** Use the **STEREO LINK** button to turn gate linking for paired channels on or off, and the **KEYIN SOURCE** field to select a trigger source as required.



- Pressing the **[F2]** key while holding the Display section **[SHIFT]** key has the same effect as the **STEREO LINK** button.

**6** Move the cursor to the parameter you want to edit and use either the **[DATA/JOG]** dial or **[INC]/[DEC]** keys to set the parameter as required.



- You can save your current gate settings in the library as described in "EQ/Dynamics Processor Library Operation" on page 154.

## Using the Compressors

Compression can be used to prevent signals from exceeding a preset level in order to avoid distortion, and to smooth out the levels of certain instruments or tracks. The AW2400 provides compression on the following tracks.

- Input
- Track
- Stereo Output
- Bus Master
- AUX Send Master
- Effect Send Master

Compression can be controlled either via the knobs in the **DYNAMICS** screen or the physical controllers in the **Selected Channel** section.

## Compressor Control via the DYNAMICS screen

Applying and controlling compression via the dedicated dynamics screen.

**1** Use the **Layer** section, **[INPUT SEL]**, **[SEL]**, and **[STEREO SEL]** keys to select the channel to which compression is to be applied.

**2** Press the **Selected Channel** section **[DYN]** key so that its indicator lights, then press **Selected Channel knob 1, 2, 3, or 4**.

The **DYNAMICS** screen will appear.

**3** Press the **Display** section **[F3]** key, or press the **[DYN]** key as many times as necessary until the **Comp Edit** page appears.

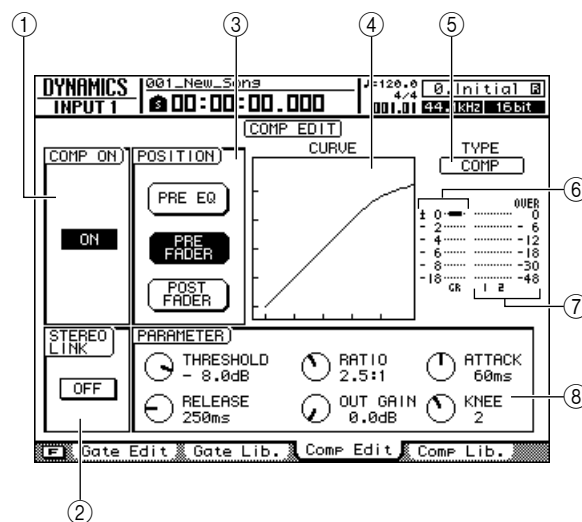

The **Comp Edit** page includes the following items.

**① COMPT ON/OFF button**

Switches the compressor on/off.

**② STEREO LINK button**

Turning this button on links compressor operation for paired channels.



- This item will not appear for the stereo output channel and bus master channels.

**③ POSITION field**

Specifies the position in the signal chain at which the compressor will be inserted.

- **PRE EQ**..... Before the channel's EQ stage (except for the effect send master)
- **PRE FADER**..... Immediately before the channel fader
- **POST FADER**..... Immediately after the channel fader

**④ Response curve**

This graph indicates the approximate response of the compressor settings. The horizontal axis of the graph is the input level, and the vertical axis is the output level.



⑤ TYPE

Indicates the currently selected compressor type. The displayed indication has the following meaning.

- **COMP** .....Compressor
- **EXPAND** .....Expander
- **COMP.(H)**.....Compander (hard)
- **COMP.(S)**.....Compander (soft)

**HINT** →

• You cannot change the compressor type via this page. If you want to use a different type, you must recall a library setting that uses the desired type. For details on recalling library compression settings, refer to "EQ/Dynamics Processor Library Operation" on page 154.

⑥ GR (Gain Reduction)

Indicates the amount of gain reduction produced by the compressor, in a range of -18 dB to 0 dB.

⑦ Output meter

Indicates the level of the signal after it has passed through the compressor.

⑧ PARAMETER

Here you can edit the parameters of the compressor. The type of parameters and their ranges will differ depending on the compressor type. For details on the types of parameter and their function, refer to the appendix.

**4 Move the cursor to the COMP ON/OFF button and press the [ENTER] key to turn the compressor on.**

**HINT** →

• Pressing the [F1] key while holding the Display section [SHIFT] key has the same effect as the ON/OFF button.

**5 Use the STEREO LINK button to turn compressor linking for paired channels on or off, and the POSITION field to select the compressor insert point as required.**

**HINT** →

• Pressing the [F2] key while holding the Display section [SHIFT] key has the same effect as the STEREO LINK button.

**6 Move the cursor to the parameter you want to edit and use either the [DATA/JOG] dial or [INC]/[DEC] keys to set the parameter as required.**

**HINT** →

• You can save your current compressor settings in the library as described in "EQ/Dynamics Processor Library Operation" on page 154.

**■ Compressor Control via the Selected Channel section**

Applying and controlling compression by using knobs 1–4 in the Selected Channel section.

**1 Use the Layer section, [INPUT SEL], [SEL], and [STEREO SEL] keys to select the channel to which compression is to be applied.**

**2 Press the Selected Channel section [DYN] key so that it's indicator lights.**

With the default settings the DYNAMICS screen will appear automatically. The display will not change if the UTILITY screen Preference page AUTO DISPLAY button is set to OFF.

**3 Rotate Selected Channel knobs 1–4.**

The parameters for the channels selected in step 1 will change accordingly.

The knobs control the following parameters.

Selected Channel knobs 1–4	1	2	3	4
Parameters	TOTAL*	Threshold	Ratio	Gain

\* TOTAL: Multiple parameters are changed simultaneously to vary the compression effect.

If the UTILITY screen Preference page AUTO DISPLAY button is set to OFF, a popup window showing the current compression settings will appear while Selected Channel knobs 1–4 are being operated.

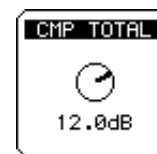

## EQ/Dynamics Processor Library Operation

The AW2400 includes “setup libraries” that contain preset EQ, gate, and compressor settings that can be recalled and used in a variety of situations. The libraries can also be used to store your own settings for easy recall as needed.

### HINT

- If necessary library recall can be automated using the AW2400's Automix record/playback capabilities (→ p. 181).

### Accessing the EQ/Dynamics Library screens

This section describes the procedure for accessing the EQ/Dynamics Library screens and recalling library presets.

#### ■ Recalling EQ Library settings

From this library you can recall EQ settings to the currently selected channel. Of library numbers 001–128, numbers 001–040 are read-only, and 041–128 can be used to store your own settings.

EQ library operations are performed via the PAN/EQ screen EQ Lib. page.

- 1 Use the Layer section, [INPUT SEL], [SEL], and [STEREO SEL] keys to select the target channel.
- 2 Press the Selected Channel section [PAN/EQ] key so that its indicator lights, then press Selected Channel knob 2, 3, or 4. The PAN/EQ screen will appear.
- 3 Press the Display section [F2] key, or press the [PAN/EQ] key as many times as necessary until the EQ Lib. page appears.

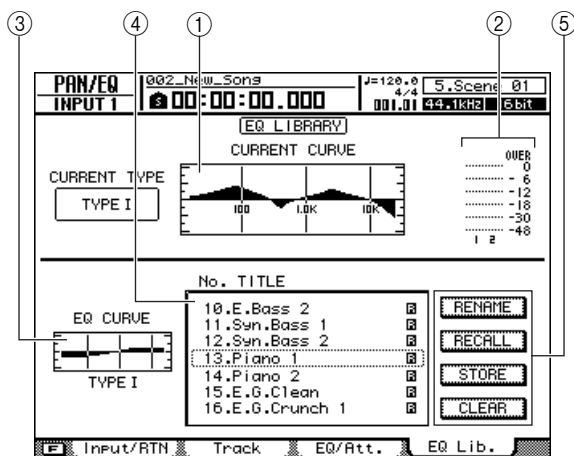

The EQ Lib. page includes the following items.

- ① **Current Response Curve**  
A graphic representation of the current EQ curve for the currently selected channel.
- ② **Output Meter**  
Displays the signal level after the EQ stage.
- ③ **EQ Curve**  
A graphic representation of the EQ curve of the currently selected EQ setting in the library list.
- ④ **List**  
A list of all the settings stored in the library. The row highlighted by a dotted frame is the setting currently selected for operation. An **R** icon indicates read-only library settings.

### NOTE

- When a TYPE II EQ library preset is recalled to a channel that only allows TYPE I EQ (the input channels, effect return channels, and AUX channels), the EQ preset will be recalled as TYPE I EQ.

- ⑤ **Buttons**  
These buttons execute the RENAME, RECALL, STORE, and CLEAR functions. Detailed description of their operation begins on page 156.

#### ■ Recalling Gate Library settings

From this library you can recall gate settings to the currently selected input channel. Of library numbers 001–128, numbers 001–004 are read-only, and 005–128 can be used to store your own settings.

Gate library operations are performed via the DYNAMICS screen Gate Lib. page.

- 1 Use the Layer section, [INPUT SEL] and [SEL] keys to select the target channel.
- 2 Press the Selected Channel section [DYN] key so that its indicator lights, then press Selected Channel knob 1, 2, 3, or 4.

The DYNAMICS screen will appear.

- 3 Press the Display section [F2] key, or press the [DYN] key as many times as necessary until the Gate Lib. page appears.

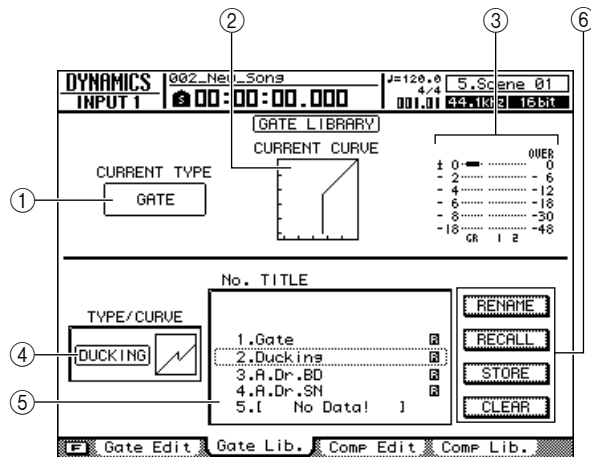

The Gate Lib. page includes the following items.

① **Current Type**

The currently selected gate type for the currently selected channel.

② **Current Gate Response**

A graphic representation of the current gate response for the currently selected channel. The horizontal axis represents input level, and the vertical axis represents output level.

③ **Meter**

Displays the signal level after the gate, and the amount of gain reduction.

④ **Gate Curve**

A graphic representation of the gate curve of the currently selected gate setting in the library list.

⑤ **List**

A list of all the settings stored in the library. The row highlighted by a dotted frame is the setting currently selected for operation. An **R** icon indicates read-only library settings.

⑥ **Buttons**

These buttons execute the RENAME, RECALL, STORE, and CLEAR functions. Detailed description of their operation begins on page 156.

## ■ Recalling Compressor Library Settings –

From this library you can recall compressor settings to the currently selected channel. Of library numbers 001–128, numbers 001–036 are read-only, and 037–128 can be used to store your own settings.

Compressor library operations are performed via the DYNAMICS screen Comp Lib. page.

- 1 Use the Layer section, [INPUT SEL], [SEL], and [STEREO SEL] keys to select the target channel.

- 2 Press the Selected Channel section [DYN] key so that its indicator lights, then press Selected Channel knob 1, 2, 3, or 4.

The DYNAMICS screen will appear.

- 3 Press the Display section [F4] key, or press the [DYN] key as many times as necessary until the Comp Lib. page appears.

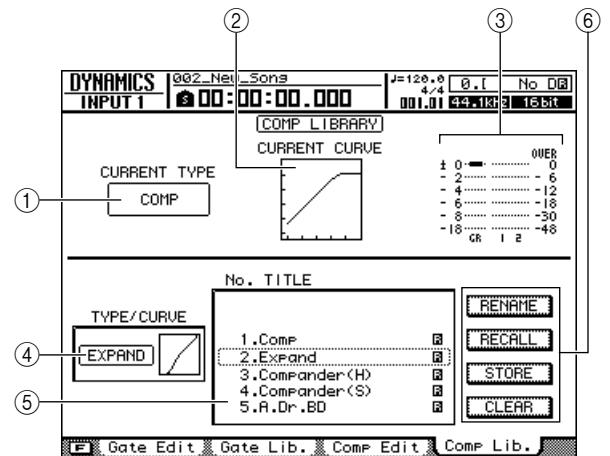

The Comp Lib. page includes the following items.

① **Current Type**

The currently selected compressor type for the currently selected channel.

② **Current Compression Response**

A graphic representation of the current compression response for the currently selected channel. The horizontal axis represents input level, and the vertical axis represents output level.

③ **Meter**

Displays the signal level after the compressor, and the amount of gain reduction.

④ **Compression Curve**

A graphic representation of the compression curve of the currently selected compressor setting in the library list.

⑤ **List**

A list of all the settings stored in the library. The row highlighted by a dotted frame is the setting currently selected for operation. An **R** icon indicates read-only library settings.

## ⑥ Buttons

These buttons execute the RENAME, RECALL, STORE, and CLEAR functions. For details on their operation refer to the following explanations.

## Changing EQ/Dynamics Library Names

Here's how you can change the names of the settings in the libraries.

### NOTE

- The names of read-only library settings (those marked with an **R** icon) cannot be changed.

### 1 Access the page containing the library to be edited.

For details on accessing the various library pages refer to “Accessing the EQ/Dynamics Library screens” on page 154.

### 2 Rotate the [DATA/JOG] dial to select the library setting to be edited.

The setting highlighted by a dotted frame is currently selected for editing.

### HINT

- The [INC]/[DEC] keys can also be used to select library settings.

### 3 Move the cursor to the RENAME button and press the [ENTER] key.

The NAME EDIT popup window will appear.

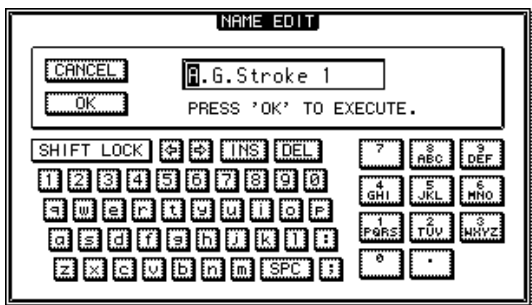

### HINT

- Pressing the [F4] key while holding the Display section [SHIFT] key has the same effect as the RENAME button.

### 4 Enter a name for the selected library setting, move the cursor to the OK button, and press the [ENTER] key (refer to page 32 for details on name entry).

This confirms and enters the new name.

## Recalling EQ/Dynamics Library settings

The procedure for recalling stored library settings is as follows.

### 1 Access the page containing the library settings to be recalled.

For details on accessing the various library pages refer to “Accessing the EQ/Dynamics Library screens” on page 154.

### 2 Rotate the [DATA/JOG] dial to select the library setting to be recalled.

The setting highlighted by a dotted frame is currently selected for recall.

### 3 Move the cursor to the RECALL button and press the [ENTER] key.

A popup window confirming the recall operation will appear.

The following illustration is an example of when the RECALL button is pressed in the PAN/EQ screen EQ Lib. page.

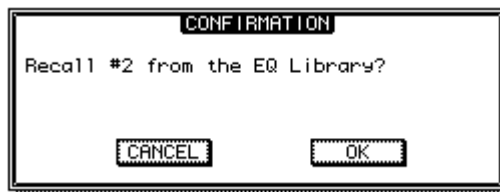

### HINT

- Pressing the [F1] key while holding the Display section [SHIFT] key has the same effect as the RECALL button.

### 4 To actually recall the selected setting move the cursor to the OK button and press the [ENTER] key.

### HINT

- The recall confirmation popup window can be disabled if desired. Refer to “AW2400 Preferences” on page 211 for details.

## Storing EQ/Dynamics Library settings

The procedure for storing library settings is as follows.

### NOTE

- New settings cannot be stored to read-only library settings (those marked with an **R** icon).
- If you select and store to a library number that contains previously-stored data, the previous data will be overwritten.

### 1 Access the page containing the library to which the settings are to be stored.

For details on accessing the various library pages refer to “Accessing the EQ/Dynamics Library screens” on page 154.

### 2 Rotate the [DATA/JOG] dial to select the library number to which the settings are to be stored.

The setting highlighted by a dotted frame is currently selected for storage.

### 3 Move the cursor to the STORE button and press the [ENTER] key.

The NAME EDIT popup window will appear.

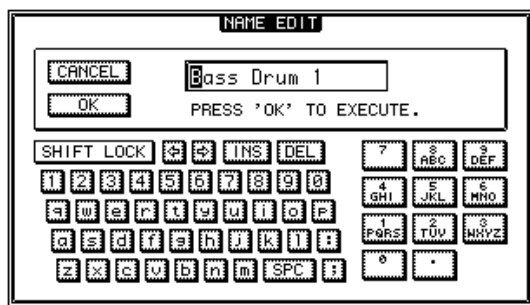

### HINT

- Pressing the [F2] key while holding the Display section [SHIFT] key has the same effect as the STORE button.

### 4 As required, enter a name for the selected library setting, move the cursor to the OK button, and press the [ENTER] key (refer to page 32 for details on name entry).

The library setting will be stored.

### HINT

- The store NAME EDIT popup window can be disabled if desired. Refer to “AW2400 Preferences” on page 211 for details.

## Erasing EQ/Dynamics Library settings

The procedure for erasing unwanted library settings is as follows.

### NOTE

- Read-only library settings (those marked with an **R** icon) cannot be erased.

### 1 Access the page containing the library settings to be erased.

For details on accessing the various library pages refer to “Accessing the EQ/Dynamics Library screens” on page 154.

### 2 Rotate the [DATA/JOG] dial to select the library setting to be erased.

The setting highlighted by a dotted frame is currently selected to be erased.

### 3 Move the cursor to the CLEAR button and press the [ENTER] key.

A popup window confirming the clear operation will appear.

The following illustration is an example of when the CLEAR button is pressed in the PAN/EQ screen EQ Lib. page.

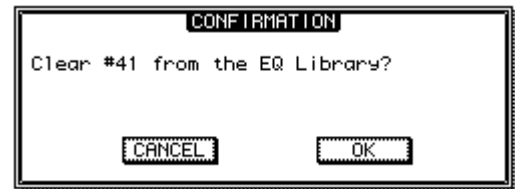

### HINT

- Pressing the [F3] key while holding the Display section [SHIFT] key has the same effect as the CLEAR button.

### 4 To actually erase the selected setting move the cursor to the OK button and press the [ENTER] key.



# ◆ Chapter 17 ◆

## Scene Memory

In this section we'll cover the functions and operation of the AW2400's scene memory.

### About Scene Memory

The AW2400 allows the mix, effect, and other parameters for all channels to be stored in internal "scene" memory. Up to 99 scenes can be stored for each song. Stored scenes can be recalled at any time via the AW2400 panel controls or via MIDI program change commands. Scene recall operations can also be recorded and played back as Automix data.

The main parameters stored with each scene are as follows:

- Fader positions for all channels and buses
- [ON] key settings
- Pan settings
- EQ settings
- Dynamics settings
- Attenuation settings
- Phase settings
- Routing settings
- Pair/group settings
- AUX send settings
- Effect parameter settings

### Scene Memory Operation

Scene store and recall operations are carried out from the SCENE screen Library page.

To call this page press the SCENE/AUTOMIX/USB section [SCENE] key as many times as necessary, or press the [F1] key after pressing the [SCENE] key.

This page contains the following items.

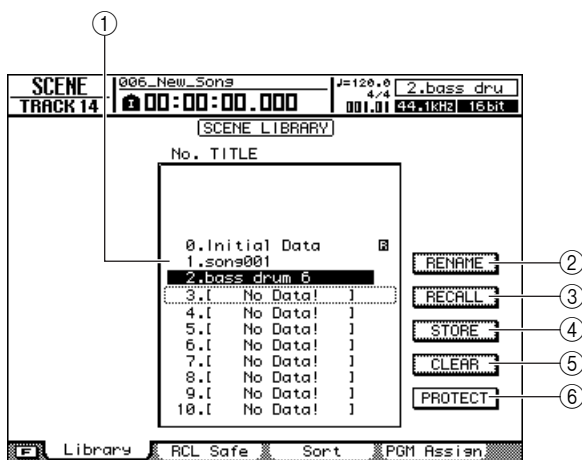

#### ① List

This area lists the data stored in the scene memory. The line enclosed by the dotted frame indicates the data that is selected for operation. Read-only data is indicated by a "lock" icon.

#### ② RENAME button

Accesses the NAME EDIT popup window, where you can edit the name of the scene selected in the list.

#### ③ RECALL button

Recalls the scene that is selected in the list.

#### ④ STORE button

Stores the current settings into the location selected in the list.

#### ⑤ CLEAR button

Deletes the scene that is selected in the list.

#### ⑥ PROTECT button

Applies protection to the scene that is selected in the list.

## Renaming a scene

Entering a new name for a scene.

**1** Call the SCENE screen Library page by either pressing the [SCENE] key as many times as necessary, or by pressing the [F1] key after pressing the [SCENE] key.

**2** Rotate the [DATA/JOG] dial to select the scene to be renamed.

The dotted frame indicates the currently selected scene. You can use the [DATA/JOG] dial to scroll through the list regardless of the position of the cursor.



- In addition to the [DATA/JOG] dial, the [INC]/[DEC] keys can be used to make selections.

**3** Move the cursor to the RENAME button and press the [ENTER] key.

The NAME EDIT popup window will appear.

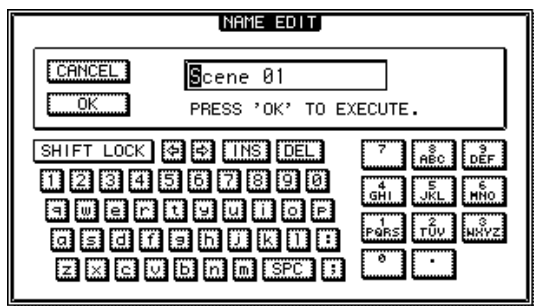

- Pressing the [F4] key while holding the Display section [SHIFT] key has the same effect as the RENAME button.

**4** Enter the new name. Then move the cursor to the OK button and press the [ENTER] key. (For details on entering a name → p. 32)

The new name will be applied.

## Recalling scene data

Here's how to recall (load) settings from a scene.

**1** Call the SCENE screen Library page by either pressing the [SCENE] key as many times as necessary, or by pressing the [F1] key after pressing the [SCENE] key.

**2** Turn the [DATA/JOG] dial to scroll the list so that the scene you want to recall is enclosed in the dotted frame.

**3** Move the cursor to the RECALL button and press the [ENTER] key.

A popup window will ask you to confirm the Recall operation.



- Pressing the [F1] key while holding the Display section [SHIFT] key has the same effect as the RECALL button.

**4** To execute the recall operation, move the cursor to the OK button and press the [ENTER] key.

The scene will be recalled.



- The confirmation popup window can be disabled so that it does not appear when you perform a Recall operation. For details, refer to "AW2400 Preferences" (→ p. 211).



## Storing scene data

Here's how to store the current settings in a scene memory.

**NOTE**

- Scene 0 is a recall-only scene to which new data cannot be stored.
- If you select and store to a scene that already contains data, the previous scene data will be overwritten and lost. Be careful not to overwrite scene data you want to keep.

**1** Call the SCENE screen Library page by either pressing the [SCENE] key as many times as necessary, or by pressing the [F1] key after pressing the [SCENE] key.

**2** Use the [DATA/JOG] dial to scroll through the list to select the store destination (the store destination should be enclosed in the dotted frame).

**3** Move the cursor to the STORE button and press the [ENTER] key.

The NAME EDIT popup window will appear, allowing you to assign a name to the data.

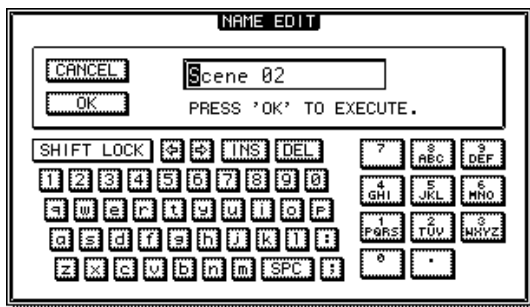

**HINT**

- Pressing the [F2] key while holding the Display section [SHIFT] key has the same effect as the STORE button.

**4** Enter the name as required, then move the cursor to the OK button and press the [ENTER] key. (For details on entering a name → p. 32)

The scene will be stored.

## Deleting scene data

Here's how you can delete unwanted scene data.

**1** Call the SCENE screen Library page by either pressing the [SCENE] key as many times as necessary, or by pressing the [F1] key after pressing the [SCENE] key.

**2** Use the [DATA/JOG] dial to scroll through the list to select the scene to be deleted (the selected scene should be enclosed in the dotted frame).

**3** Move the cursor to the CLEAR button and press the [ENTER] key.

A popup window will appear, asking you to confirm the Delete operation.

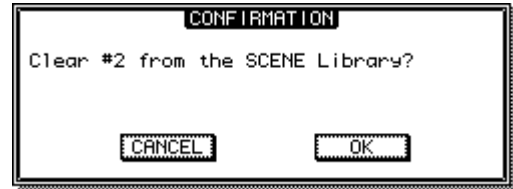

**HINT**

- Pressing the [F3] key while holding the Display section [SHIFT] key has the same effect as the CLEAR button.

**4** To execute the Delete operation, move the cursor to the OK button and press the [ENTER] key.

The scene will be deleted.

## Protecting a scene

Applying protection to a scene so that it can't be edited or erased.

**1** Call the SCENE screen Library page by either pressing the [SCENE] key as many times as necessary, or by pressing the [F1] key after pressing the [SCENE] key.

**2** Use the [DATA/JOG] dial to scroll through the list to select the scene to be protected (the selected scene should be enclosed in the dotted frame).

**3** Move the cursor to the PROTECT button and press the [ENTER] key.

When protection is turned on the PROTECT button will appear inverted and a lock icon will appear to the right of the scene name.

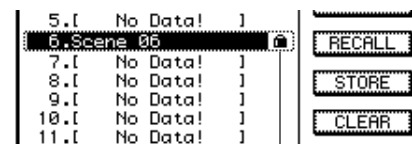

"lock" icon

# Using the Recall Safe function

You can specify that specific faders or specific channels will be excluded from Recall operations when the scene is changed either manually or from an external MIDI device. This function is called “Recall Safe.”

This is convenient, for example, if you are performing a mixdown while switching scenes, but want to control specific channels manually.

**1 Call the RCL Safe page by either pressing the [SCENE] key as many times as necessary, or by pressing the [F2] key after pressing the [SCENE] key.**

The SCENE screen RCL Safe page will appear.

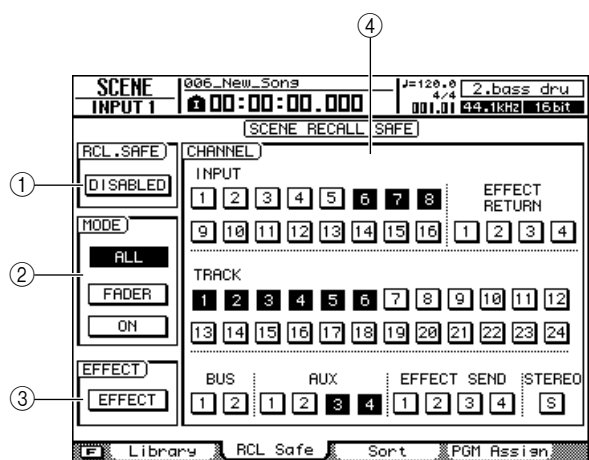

**1 RCL.SAFE button**

This button switches Recall Safe between ENABLE and DISABLE. Move the cursor to this button and press the [ENTER] key to switch to either ENABLE or DISABLE.



- Pressing the [F1] key while holding the Display section [SHIFT] key has the same effect as the RCL.SAFE button.

**2 MODE field**

The recall safe parameters can be selected from the following:

- **ALL button** ..... This prevents all parameters in the scene from being recalled. The entire scene is “recall safe” and no change will occur if it is inadvertently recalled.
- **FADER button** ..... Only the fader settings will not be recalled.
- **ON button** ..... Only the [ON] key settings will not be recalled.



- Both the FADER and ON buttons can be on at the same time.
- When the ALL button is turned on the FADER and ON buttons are automatically turned off.



- Effect return settings are not affected by Recall Safe.

**3 EFFECT button**

Turn this button on to prevent recall (recall safe) of the effect settings. The button will appear inverted when on.

**4 CHANNEL field**

Selects the recall safe channels. The mix parameters of selected channels will not be recalled.

The CHANNEL field buttons correspond to the following channels.

- **INPUT** ..... Input channels 1–16
- **EFFECT RETURN** ..... Effect Return channels 1–4
- **TRACK** ..... Track channels 1–24
- **BUS** ..... Bus master 1, 2
- **AUX** ..... AUX send master 1–4
- **EFFECT SEND** ..... Effect send master 1–4
- **STEREO** ..... Stereo output channel



- All CHANNEL field buttons can be cleared (de-selected) by pressing the [F2] key while holding the Display section [SHIFT] key.

**2 Select the parameter(s) or channel(s) that you want to set to Recall Safe, and activate the corresponding button(s).**

**3 Move the cursor to the RCL.SAFE button and press the [ENTER] key.**

Recall Safe has now been enabled. The selected parameter(s) and/or channel(s) will not be affected by scene recall operations until you change this setting.



- The RCL Safe page settings are shared by all songs.

## Moving scenes

Scene data stored in any scene number from 1 through 99 can be moved to any other scene number.

- 1 Call the Sort page by either pressing the [SCENE] key as many times as necessary, or by pressing the [F3] key after pressing the [SCENE] key.

The SCENE screen Sort page will appear.

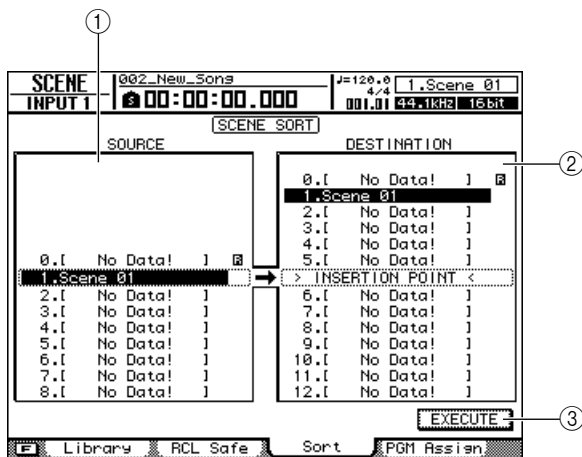

① **SOURCE list**

Displays the scenes in their current order. The scene to be moved is selected from this list.

② **DESTINATION list**

The move destination for the source scene selected from the SOURCE list is selected here.

③ **EXECUTE button**

Executes the scene move operation.

- 2 Move the cursor to the SOURCE list and use the [DATA/JOG] dial to select the scene to be moved.



• In addition to the [DATA/JOG] dial, the [INC]/[DEC] keys can be used to make selections.

- 3 Move the cursor to the DESTINATION list and use the [DATA/JOG] dial to select the destination.

The destination will be indicated by the “INSERT POINT” indication in this list.

- 4 Move the cursor to the EXECUTE button and press the [ENTER] key.

The selected scene will be moved and the SOURCE and DESTINATION lists will be updated to reflect the results of the operation.



• Pressing the [F1] key while holding the Display section [SHIFT] key has the same effect as the EXECUTE button.



# ◆ Chapter 18 ◆

## Song management

This chapter explains how to perform song management operations such as copying, deleting, backing up, and restoring songs.

### About songs

#### ■ Song Organization

On the AW2400, your recorded compositions are managed in units called “songs.” When you save a song on the hard disk, the audio data, scene memories, and the data for each library are all stored together. By loading a saved song, you can return it to the original condition at any time.

You can store as many songs on the internal hard disk as its capacity allows. Songs stored on hard disk are divided into a song file containing all the basic setup information for the song, and WAV files containing the audio data.

#### ■ Song Bit Depth

The AW2400 allows the bit depth of individual songs to be set to either 16 or 24 bits. 24-bit songs are capable of providing higher audio quality than 16-bit songs, but the following limitations on the number of simultaneous record/playback tracks apply.

Song Bit Depth	Max. Simultaneous Record Tracks	Max. Simultaneous Play Tracks
16 bits	16	8
	:	:
	1	23
	0*	24*
24 bits	8	4
	:	:
	1	11
	0*	12*

\* For mixdown the number of simultaneous record tracks is two, and the number of simultaneous playback tracks is 24 for 16-bit songs, or 12 for 24-bit songs.

Only 24-bit audio data can be used in 24-bit songs. 16-bit WAV files cannot be imported from a computer or CD-RW drive. Audio data imported from audio CDs, however, will be automatically converted to 24-bit format. In the same way, only 16-bit audio data can be used in 16-bit songs.

## ■ Song Folder Organization

Song and related data stored on hard disk can be accessed from a computer connected via USB in the same way as the hierarchical files and folders on the computer's hard disk. The folders are organized as follows:

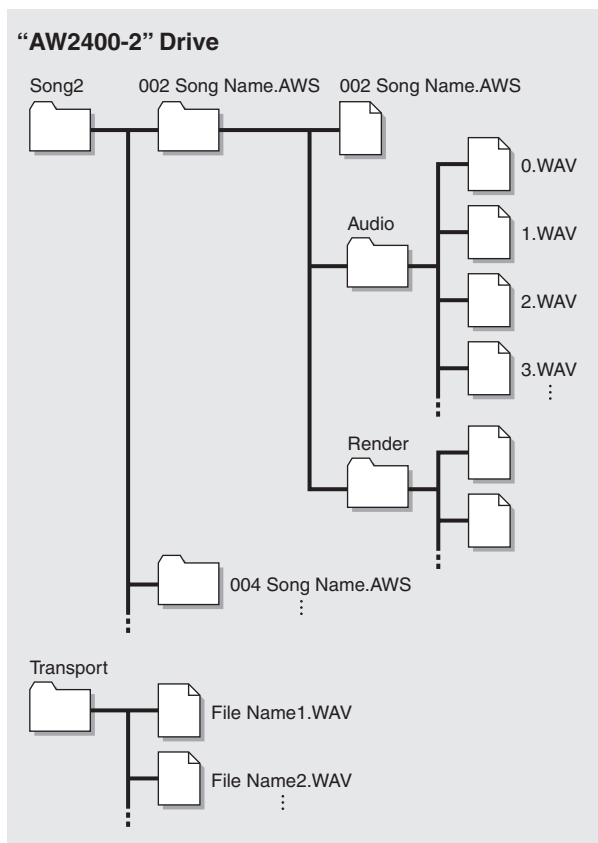
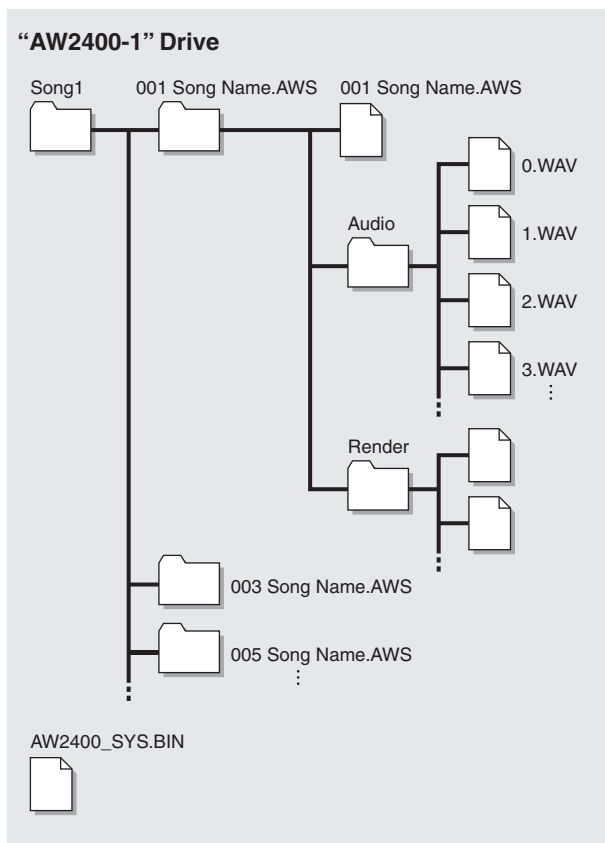

### ■ “Song1” Folder

Songs are stored in either the “Song1” or “Song2” folder.

#### ■ Individual Song Folders

Each song is stored in a folder bearing the song's name (extension .AWS).

#### ● Song Files

The following song settings are stored in a file bearing the name of the song (extension .AWS):

- Recorder section settings (SONG screen, TRACK screen).
- Mixer section settings (channels, effects).
- Library settings.
- REMOTE screen settings.

#### ■ “Audio” Folder

The following song audio data is saved in WAV file format. File names are automatically created in the order of recording, as in: “0.WAV”, “1.WAV”, “2.WAV”, etc. 24-bit song data is saved as 32-bit WAV files.

- 24 + 2 (stereo track) audio x 8 virtual tracks.
- Sound clip audio data.
- Audio data for undo and redo operations.

#### ● System File (AW2400\_SYS.BIN)

Stores UTILITY screen settings and information for data management.

### ■ “Song2” Folder

Songs are stored in either the “Song1” or “Song2” folder.

#### ■ “Transport” Folder

This folder is used to store WAV files for import and export. Data is stored as 16-bit or 24-bit WAV files.

The following operations are possible by directly accessing the data on the internal hard disk from a computer. For detailed operating procedures refer to “WAV File Transfer (USB Storage Mode)” on page 230.

- Specified audio data on the internal hard disk can be directly edited from a computer using an appropriate waveform editor application. The song will become unplayable if you change the sampling frequency or quantization of the audio data, but you can change the length of the waveforms without problems.
- WAV files transferred from a computer to the “Transport” folder can be imported to the AW2400 audio tracks as required, and specified regions of audio data can be exported to the computer as WAV files which can then be imported into computer-based DAW applications.
- The entire contents of the internal hard disk or individual songs can be backed up to the computer.

## NOTE

- For 24-bit songs, the audio data contained in the “Audio” folders is stored in 32-bit WAV format. If your waveform editor application cannot handle 32-bit data, first export the WAV file(s) to the “Transport” folder. WAV files imported or exported via the “Transport” folder are automatically converted to 24-bit format that can be edited using most waveform editor software.
- Song data is created in either the “Song1” or “Song2” folder. You may have to check both of these folders to locate a specific song.
- If you initialize the AW2400 hard disk from your computer it will become unreadable by the AW2400. Always use the SONG screen Song List page to initialize the AW2400 hard disk.
- The song folders also contain audio data for undo and redo operations that is not normally used. The undo/redo data can be deleted by performing an Optimize operation (→ p. 172).

## Managing Your Songs

Song management operations are accessed via the SONG screen Song List page. This page also includes the shutdown functions.

To call this page press the [SONG] key in the Work Navigate section a number of times, or press the [F1] key after pressing the [SONG] key.

This page contains the following items.

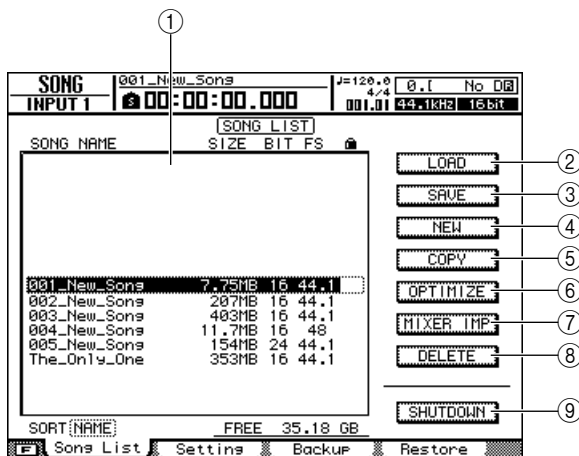

### ① Song List

The songs stored on the internal AW2400 hard disk are displayed here.

### ② LOAD button

Loads a specified song.

### ③ SAVE button

Saves a song.

### ④ NEW button

Creates a new song.

### ⑤ COPY button

Copies a song.

### ⑥ OPTIMIZE button

Optimizes a song.

### ⑦ MIXER IMP button

Imports data from another song.

### ⑧ DELETE button

Deletes a song.

### ⑨ SHUTDOWN button

This function is used when turning the AW2400 power off. Refer to page 38 for detailed shutdown instructions.

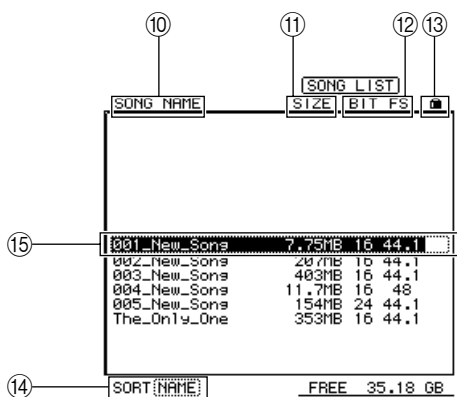

- ⑩ **Song Name**
- ⑪ **Song Size**
- ⑫ **Song Bit Depth/Sampling Frequency**
- ⑬ **Song Protect Status**
- ⑭ **SORT box**  
Changes the order of songs displayed in the Song List.
- ⑮ **The currently-selected song**

### ■ Creating a new song

In order to begin recording on the AW2400, you must first create a new song.

**1** Call the Song List page by either pressing the Work Navigate section [SONG] key as many times as necessary, or by pressing the [F1] key after pressing the [SONG] key.

The SONG screen Song List page will appear. The currently selected song in the Song List will be highlighted (inverted).

**2** Move the cursor to the NEW button and press the [ENTER] key.

A popup window will ask you whether you want to save the current song.

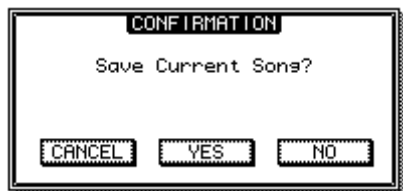

• Pressing the [F3] key while holding the Display section [SHIFT] key has the same effect as the NEW button.

**3** Move the cursor to YES (to save the current song) or NO (if you don't want to save the current song) and press the [ENTER] key.

A popup window containing the various settings for the new song will appear.

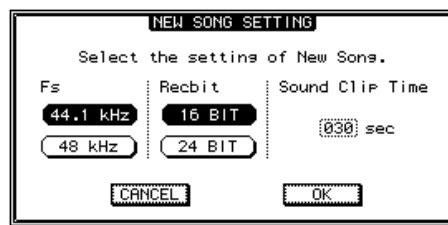

The following settings can be made via this popup window.

- **Fs** ..... The sample rate of the new song can be set to either 44.1 kHz or 48 kHz.
- **Recbit** ..... The bit depth of the new song can be set to either 16 or 24 bits.
- **Sound Clip Time** ..... The record time of the Sound Clip.



• If you set the sample rate to 48 kHz, the song data will not be able to be written as an audio CD.

**4** When each parameter has been set as required, move the cursor to the OK button and press the [ENTER] key.

Next, a popup window will appear allowing you to specify settings that will be carried over from the current song.



You may choose one or more of the following items.

- **SCENE Button** ..... Scene memories
- **TEMPO button** ..... Tempo map
- **LIBRARY button** ..... EQ, dynamics, effects, and channel libraries

For example, if you have saved effect settings in a library for the current song and would like to use these settings for the new song as well, you would turn on the LIBRARY button.



- 5 Select the buttons of the items you want to carry over from the current song, move the cursor to the OK button, and press the [ENTER] key.

The NAME EDIT popup window will appear, allowing you to enter a name for the song.

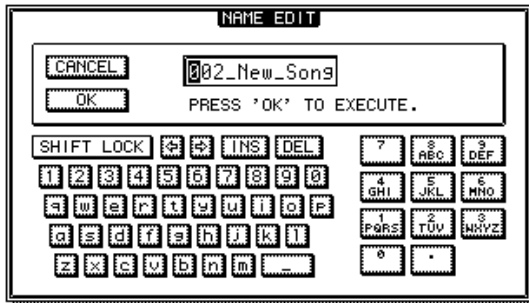

- 6 Assign a name to the song (for details on assigning a name → p. 32).

**NOTE**

- A new song cannot be given the same name as an existing song.

- 7 To create the new song, move the cursor to the OK button and press the [ENTER] key.

A new song will be created, and you will return to the SONG screen Song List page.

**HINT**

- If you move the cursor to the CANCEL button (instead of the OK button) and press the [ENTER] key, you will return to the SONG screen Song List page without creating a new song.
- You may also edit the song name later.

## ■ Editing the song name

Here's how to edit the song name that is assigned when you create a new song.

**NOTE**

- This setting applies only to the current song. Before you perform this procedure, load the song for which the name is to be edited.

- 1 Call the Setting page by either pressing the Work Navigate section [SONG] key as many times as necessary, or by pressing the [F2] key after pressing the [SONG] key.

The SONG screen Setting page will appear.

- 2 To edit the song name, move the cursor to the RENAME button and press the [ENTER] key.

The NAME EDIT popup window will appear, allowing you to edit the song name.

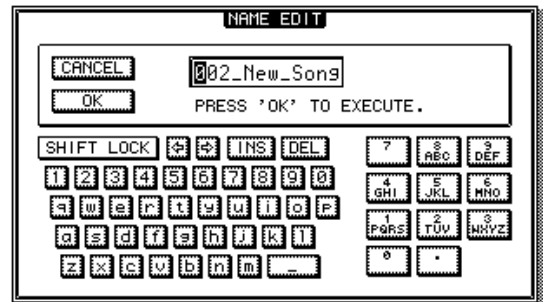

- 3 Enter the new name. Then move the cursor to the OK button and press the [ENTER] key.

The new name will be applied, and the popup window will close. (For details on inputting a name → p. 32)

## ■ Loading and Sorting Songs

Here's how to load an existing song from the hard disk.

- 1 Call the Song List page by either pressing the Work Navigate section [SONG] key as many times as necessary, or by pressing the [F1] key after pressing the [SONG] key.

The SONG screen Song List page will appear. The currently selected song in the Song List will be highlighted (inverted).

- 2 To change the order of the songs move the cursor to the SORT box, use the [DATA/JOG] dial to select the desired sort criterion, and then press the [ENTER] key.



Using the SORT box songs can be sorted according to the following criteria:

- **NAME** ..... Song names in alphabetical order.
- **OLD** ..... The order in which the songs were saved, from newest to oldest.
- **SIZE** ..... Song size, from largest to smallest.

- 3 To load a song move the cursor to a location outside the SORT box, and use the [DATA/JOG] dial to select the song to be loaded.

The line enclosed by the dotted frame indicates the selected song.

- 4 Move the cursor to the LOAD button in the screen, and press the [ENTER] key.

A popup window will ask you whether you want to save the current song.

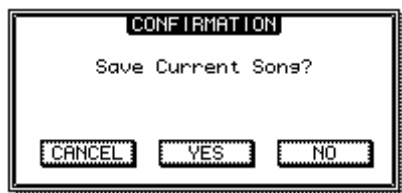

- Pressing the [F2] key while holding the Display section [SHIFT] key has the same effect as the LOAD button.

- 5 Move the cursor to either YES (if you want to save the current song) or NO (if you do not want to save the current song), and press the [ENTER] key.

If you select "YES", the song will be loaded after the current song has been saved. If you select "NO", the song will be loaded and any changes to the current song will be discarded.

The load operation can be aborted by moving the cursor to the CANCEL button and pressing the [ENTER] key.



- If you select NO, all changes you made after last saving the current song will be lost.

## ■ Saving the current song

Here's how to save the current song to the hard disk.

- 1 Call the Song List page by either pressing the Work Navigate section [SONG] key as many times as necessary, or by pressing the [F1] key after pressing the [SONG] key.

The SONG screen Song List page will appear.

- 2 Move the cursor to the SAVE button and press the [ENTER] key.

A popup window will ask you to confirm that you want to save the current song.



- Pressing the [F1] key while holding the Display section [SHIFT] key has the same effect as the SAVE button.

- 3 To save the song, move the cursor to the OK button and press the [ENTER] key.

The song will be saved and the display will revert to the Song List (step 1). If you move the cursor to the CANCEL button (instead of the OK button) and press the [ENTER] key, the Save operation will be cancelled.



- The song save operation always saves the current song, regardless of the song that is selected in the list.
- You cannot save a song that is protected. If for example you have edited the mixer settings and need to save the song, you must disable the protect setting and then save the song.



- If necessary, you can change the name of the song before you save it (→ p. 169).
- In the following situations, a popup window will ask whether you want to save the current song; when you load an existing song from the hard disk, when you create a new song, or when you shut-down the AW2400.
- We recommend that you frequently save the song you are working on or enable the Auto Save function (→ p. 211) as a safeguard against data loss due to accidents such as the AW2400's power cable being inadvertently disconnected.

## ■ Deleting a song

Here's how to delete a song from the hard disk.

**NOTE**

- A deleted song will be lost forever. Use great caution when deleting a song.
- You cannot delete a song for which protect is on, or delete the current song (the highlighted song). In order to delete a protected song or the current song, you must first turn off the protect setting or switch to a different song.

- 1 Call the Song List page by either pressing the Work Navigate section [SONG] key as many times as necessary, or by pressing the [F1] key after pressing the [SONG] key.**

The SONG screen Song List page will appear. The currently selected song in the Song List will be highlighted (inverted).

- 2 Move the cursor to a location outside the SORT box, and use the [DATA/JOG] dial to select the song to be deleted.**

The line enclosed by the dotted frame indicates the selected song to be deleted.

- 3 Move the cursor to the DELETE button and press the [ENTER] key.**

A popup window will ask you to confirm the delete operation.



- 4 To delete the song, move the cursor to the OK button and press the [ENTER] key.**

The song you selected in step 2 will be deleted, and you will return to step 1. If you move the cursor to the CANCEL button and press the [ENTER] key, the delete operation will be cancelled.

## ■ Copying a song

Here's how to copy a song in the hard disk.

- 1 Call the Song List page by either pressing the Work Navigate section [SONG] key as many times as necessary, or by pressing the [F1] key after pressing the [SONG] key.**

The SONG screen Song List page will appear. The currently selected song in the Song List will be highlighted (inverted).

- 2 Move the cursor to a location outside the SORT box, and use the [DATA/JOG] dial to select the song to be copied.**

The line enclosed by the dotted frame indicates the selected song to be copied.

- 3 Move the cursor to the COPY button and press the [ENTER] key.**

A popup window will prompt you to enter new song name.

**HINT**

- If you have selected the current song as the song to be copied, a popup window will ask you whether you want to save the current song. Move the cursor to either the YES button (if you want to save) or the NO button (if you don't want to save), and then press the [ENTER] key.

- 4 Enter a new song title. (For details on inputting a name → p. 32)**

- 5 When the song name has been entered, move the cursor to the OK button and press the [ENTER] key.**

A popup window will ask you to confirm the copy operation.



- 6 To execute the copy, move the cursor to the OK button and press the [ENTER] key.**

The song you selected in step 2 will be copied, and you will return to step 1. If you move the cursor to the CANCEL button and press the [ENTER] key, the copy operation will be cancelled.

## ■ Song Protection

Songs can be “protected” to prevent unwanted changes to the data. When a song is protected it can’t be recorded to, edited, or deleted.

- 1 Call the Setting page by either pressing the Work Navigate section [SONG] key as many times as necessary, or by pressing the [F2] key after pressing the [SONG] key.

The SONG screen Setting page will appear.

- 2 Move the cursor to a location outside the SORT box, and use the [DATA/JOG] dial to select the song to be protected.

The line enclosed by the dotted frame indicates the selected song to be protected.

- 3 Move the cursor to the PROTECT button and press the [ENTER] key.

When protection is turned on the PROTECT button will be highlighted and a “lock” icon will appear to the right of the song name.

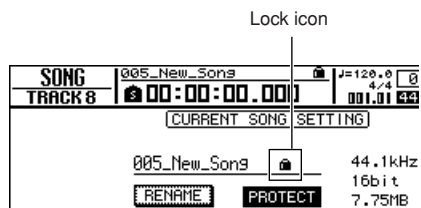

**HINT**

- We recommend that you turn protect on for important songs.
- Even if protect is on, you can still copy the song (→ p. 171) and adjust the mixer settings.

## ■ Optimizing a song

“Optimize” is an operation that deletes the undo/redo audio data maintained within the song. When you have finished recording and editing a song you can Optimize it to increase the amount of free space on the hard disk.

**NOTE**

- The deleted undo/redo audio data will be lost forever. Use this operation with caution.

- 1 Call the Song List page by either pressing the Work Navigate section [SONG] key as many times as necessary, or by pressing the [F1] key after pressing the [SONG] key.

The SONG screen Song List page will appear. The currently selected song in the Song List will be highlighted (inverted).

- 2 Move the cursor to a location outside the SORT box, and use the [DATA/JOG] dial to select the song to be optimized.

The line enclosed by the dotted frame indicates the selected song to be optimized.

- 3 Move the cursor to the OPTIMIZE button, and press the [ENTER] key.

A popup window will ask you to confirm the optimize operation.



**HINT**

- You may select the current song to be optimized. In this case, a popup window will ask you whether you want to save the current song. Move the cursor to the OK button (if you want to save) or the CANCEL button (if you don't want to save), and press the [ENTER] key.

- 4 To execute the optimize operation, move the cursor to the OK button and press the [ENTER] key.

The undo/redo audio data of the song you selected in step 2 will be deleted, and you will return to step 1. If you decide not to execute the optimize operation, move the cursor to the CANCEL button and press the [ENTER] key.

## ■ Importing data from an existing song —

Here's how selected types of data such as scenes or libraries can be imported into the current song from a song saved on the hard disk.

**NOTE**

- When you execute this import operation, the previous data for that item in the current song will be lost. Use this procedure with caution.

**1 Call the Song List page by either pressing the Work Navigate section [SONG] key as many times as necessary, or by pressing the [F1] key after pressing the [SONG] key.**

The SONG screen Song List page will appear. The currently selected song in the Song List will be highlighted (inverted).

**2 Move the cursor to a location outside the SORT box, and use the [DATA/JOG] dial to select the song to be imported.**

The line enclosed by the dotted frame is the song you have selected as the import-source.

**3 Move the cursor to the MIXER IMP button, and press the [ENTER] key.**

A popup window will appear which allows you to select the data to be imported.

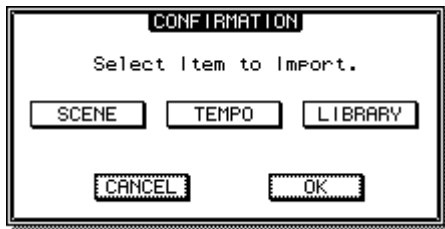

You can choose one or more of the following items.

- **SCENE button** ..... Scene memories
- **TEMPO button** ..... Tempo map
- **LIBRARY button** ..... EQ, dynamics, effects, and channel libraries

**4 Select the button(s) corresponding to the items you want to import to the current song, then move the cursor to the OK button and press the [ENTER] key.**

Importing will begin. When the data has been imported, you will return to the screen of step 1.

# Editing various settings for the song

Here's how to edit various settings for a song, such as selecting the counter display format and time code format.

**NOTE**

- These settings apply only to the current song. Before you perform this procedure, load the song to be edited.
- The counter display setting will be saved with the song data when the song is saved.

**1** Call the Setting page by either pressing the Work Navigate section [SONG] key as many times as necessary, or by pressing the [F2] key after pressing the [SONG] key.

The SONG screen Setting page will appear.

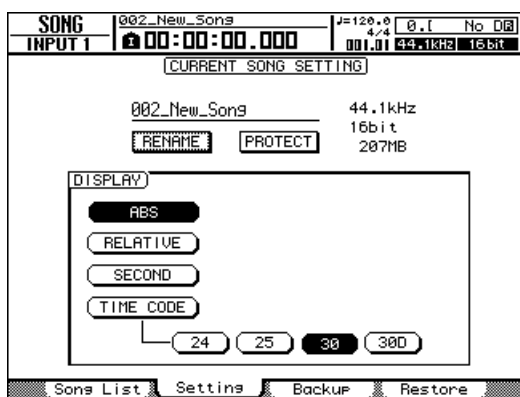

**2** To change the counter display format move the cursor to the ABS, RELATIVE, SECOND, or TIME CODE button and press the [ENTER] key.

In the Setting page, use the following buttons to select the display format for the counter that is shown in the center of the top line in the display.

- **ABS (absolute time)**  
..... Displays the current location in hours/minutes/seconds/milliseconds, with the absolute time zero location as 0.
- **RELATIVE (relative time)**  
..... Displays the current location in hours/minutes/seconds/milliseconds, with the relative time zero location as 0.
- **SECOND**..... Displays the current location in hours/minutes/seconds/milliseconds, with the Start point as 0.
- **TIME CODE** ..... Displays the current location in time code (hours/minutes/seconds/frames), with the Start point as 0.

**NOTE**

- The counter in the upper right of the display always shows the current location in measure/beat units, relative to the Start point.
- The measure/beat display will depend on the settings in the Tempo page of the EDIT screen. For details, refer to "Creating a tempo map" (→ p. 175).

**3** To change the time code frame rate move the cursor to the 24, 25, 30, or 30D button and press the [ENTER] key.

You can choose one of the following frame rates to specify the minimum unit of time code.

- **24** .....24 frames/second
- **25** .....25 frames/second
- **30** .....30 frames/second (30 non-drop frame)
- **30D** .....29.97 frames/second (30 drop-frame)

**HINT**

- This setting affects both the counter time code display and the MTC that the AW2400 transmits and receives. If the AW2400 is sending or receiving MTC to or from an external device, you must set both devices to the same frame rate.

**NOTE**

- The frame rate cannot be changed while the AW2400 is running.

# Creating a tempo map

The “tempo map” contains data that changes the tempo or time signature at the beginning of the song or at any measure or beat within the song. The measure/beat display counter, the internal metronome, and the MIDI clock data generated within the AW2400 are all based on this tempo map.

**HINT** →

- The Start point of the song corresponds to the starting location of the tempo map.
- The data (“tempo map events”) recorded in the tempo map will continue to apply until the next event of the same type is encountered.

**NOTE**

- If you modify the tempo map after recording on an audio track, the measure/beat counter display values will be affected. For this reason if you want to use MIDI clock to synchronize with an external MIDI device, or if you want to control the song in measure units, you should create the tempo map before you record. If you modify the tempo map after a track has already been recorded, a popup window will ask you for confirmation.

## ■ Editing a tempo map event

When you create a new song, the following tempo map event will be input at the beginning of the tempo map (the first beat of the first measure).

- Time signature: 4/4
- Tempo: 120.0

Here’s how to edit the values of this tempo map event.

- 1 Call the **EDIT** screen **Tempo Map** page by either pressing the **Work Navigate** section **[EDIT]** key as many times as necessary, or by pressing the **[F2]** key after pressing the **[EDIT]** key.

In this page you can input or edit tempo map events for the current song.

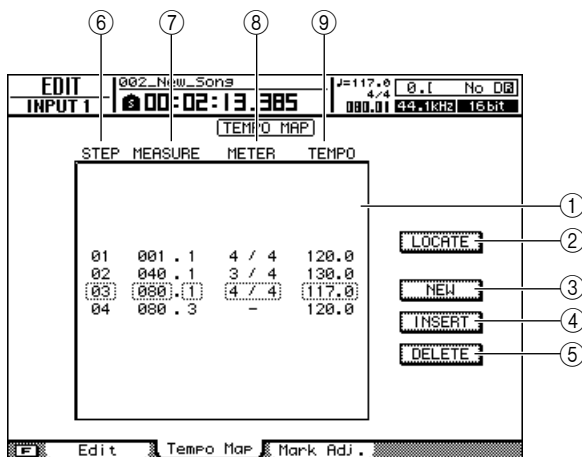

This page contains the following items.

- ① **List**  
This area lists the tempo map events that have been entered for the current song. The line enclosed by a dotted frame is the currently selected tempo map event.
- ② **LOCATE button**  
By moving the cursor to this button and pressing the **[ENTER]** key, you can move the song to the location of the tempo map event currently selected in the list.
- ③ **NEW button**  
To create an event at the beginning of the measure following the last step, move the cursor to this button and press the **[ENTER]** key.
- ④ **INSERT button**  
To insert a blank event at the step preceding the tempo map event currently selected in the list, move the cursor to this button and press the **[ENTER]** key.
- ⑤ **DELETE button**  
To delete the tempo map event currently selected in the list, move the cursor to this button and press the **[ENTER]** key.
- ⑥ **STEP**  
Indicates the step number of the tempo map event.
- ⑦ **MEASURE**  
Indicates the location (measure/beat) of the tempo map event.
- ⑧ **METER**
- ⑨ **TEMPO**  
These fields show the time signature and tempo of each tempo map event.

**2 Move the cursor to the item that you want to edit, and use the [DATA/JOG] dial to edit the value.**

If the METER or TEMPO is “–”, move the cursor to the item and press the [ENTER] key before you edit the value.

**NOTE**

- The METER and TEMPO at the beginning of the song cannot be set to “–”.
- You cannot change the METER value to other than “–” for a step that is not located at beat 1.

Event	Range	Content
METER	1/4 to 8/4, –	Specifies the time signature of the song.
TEMPO	30.0 to 250.0, –	Specifies the tempo of the song. You can set the tempo in units of 0.1 over a range of 30.0–250.0 BPM.

**HINT**

- You cannot delete the tempo map event located at the beginning of the song, or change its location. If you want to change the tempo or time signature during the song, you can insert a new event.

**■ Adding a tempo map event**

**1 Access the Tempo Map page, move the cursor to the NEW button, and press the [ENTER] key.**

A blank tempo map event will be created after the last step that is currently input.

**HINT**

- If you use the INSERT button instead of the NEW button, a blank tempo map event will be inserted before the currently selected step. However, you cannot insert an event before the tempo map event at the beginning of the song (i.e., the tempo map event that is input when you create the song).

**2 Make sure that the cursor is outside the list, and use the [DATA/JOG] dial to select a tempo map event that you created.**

When the cursor is located outside the list, you can use the [DATA/JOG] dial to scroll the contents of the list.

**3 Move the cursor to the MEASURE field of the event that is selected in the list, and turn the [DATA/JOG] dial to specify the location of the event.**

You can adjust the location of a tempo map event in units of measures or beats. However, you cannot move an event past the preceding or following event.

**4 Move the cursor to the item that you want to edit, and use the [DATA/JOG] dial to adjust the value.**

If necessary, you can play back the song to check that the tempo map event works as you expect.

**5 In the same way, use the NEW or INSERT button to add new events, and set their parameters.**

**■ Deleting a tempo map event**

Here’s how to delete an unwanted event from the tempo map. (However, you cannot delete the event that is located at the beginning of the song.)

**1 Access the Tempo Map page, and scroll the list to select the tempo map event that you want to delete.**

**2 Move the cursor to the DELETE button and press the [ENTER] key.**

The selected event will be deleted.



## Backing up songs

Here's how you can back up songs from the internal hard disk to CD-R/RW media.

### NOTE

- To backup AW2400 data to a computer, connect the AW2400 to the computer via a USB cable and copy the song folders directly from the internal AW2400 hard disk to the computer. For detailed operation refer to "WAV File Transfer (USB Storage Mode)" on page 230.

- 1 Insert CD-R/RW media into the CD-RW drive.
- 2 Call the SONG screen Backup page by either pressing the Work Navigate section [SONG] key as many times as necessary, or by pressing the [F3] key after pressing the [SONG] key.

In this page you can back up songs from the internal hard disk to CD-R/RW media.

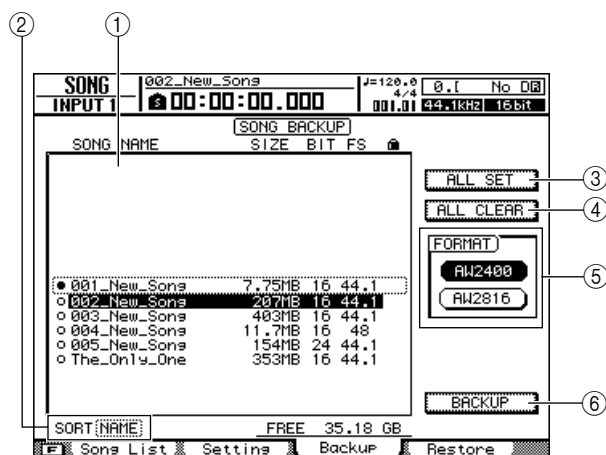

This page contains the following items.

- 1 **List**  
This area lists the songs that are saved on the hard disk. The symbols at the right of the list indicate whether the song has been selected (●) or disabled (○) for backup.
- 2 **SORT box**  
Changes the order of the songs displayed in the song list. Operation is the same as for the Song List page (→ p. 170).

- 3 **ALL SET button**

Move the cursor to this button and press the [ENTER] key to select all songs in the list for backup. Pressing the [F1] key while holding the Display section [SHIFT] key has the same affect as the ALL SET button.

- 4 **ALL CLEAR Button**

Move the cursor to this button and press the [ENTER] key to deselect all songs so that they won't be backed up. Pressing the [F2] key while holding the Display section [SHIFT] key has the same affect as the ALL CLEAR button.

- 5 **AW2400 button / AW2816 button**

Selects the backup format. If the songs are to be restored on a Yamaha AW-series workstation other than the AW2400 (AW4416, AW2816, AW1600, AW16G), select the AW2816 button. This mode only supports 44.1kHz/16-bit songs, and only one song can be backed up at a time.

- 6 **BACKUP button**

Executes backup of the selected song(s). Pressing the [F4] key while holding the Display section [SHIFT] key has the same affect as the BACKUP button.

- 3 **Make sure that the cursor is in the list area, use the [DATA/JOG] dial to select the song you want to back up, and then press the [ENTER] key.**

The symbol for the selected song will change to the (●) symbol, indicating that this song has been selected for backup. You can repeat this step to select multiple songs for backup.

If you turn on the ALL SET button, you can select all data in the list in one step.

**4 To execute the backup, move the cursor to the BACKUP button and press the [ENTER] key.**

A popup window will ask you to confirm the operation.



**NOTE**

- If previously-recorded CD-RW media is inserted in the CD-RW drive, a popup window will ask you if it is OK to erase the media first. Move the cursor to the OK button and press the [ENTER] key, and the media will be erased.
- If a CD-ROM or previously-recorded CD-R media is inserted in the CD-RW drive, a popup window with a message of "Change Media, Please" will appear, and the media will be ejected. Remove the media, and replace it with writable media.

**5 Move the cursor to the OK button and press the [ENTER] key.**

Writing to the CD-R/RW media will begin. If you decide to cancel the backup operation, move the cursor to the CANCEL button and press the [ENTER] key.

While the backup operation is being executed, a popup window will indicate the progress of the operation. When the backup has been completed, you will return to step 2.

If the backup data does not fit on a single volume of media, a message of "Number Ejected Media, Insert Blank Media." will appear, and the media will be ejected. Insert a new media volume. Then move the cursor to the OK button and press the [ENTER] key.

**NOTE**

- You cannot execute the backup operation without selecting data.
- If you execute the backup operation with the AS AW2400 button turned on, system data (the settings you make in the UTILITY screen or the MIDI screen) will be backed up on the media together with the selected data.
- If you execute the backup operation with the AS AW2816 button turned on, data other than audio tracks will not be backed up. All virtual tracks for tracks 1–16 are backup up. Tracks 17–24 are not backed up. Only the current track data for stereo track is backed up. Only 44.1kHz/16-bit songs are supported.
- When you restore data that was backed up to more than one media volume, you must insert the media in the order in which it was backed up. Be sure to make a note of the backup sequence on the label surface of each CD-R/RW disc.

## Restoring songs

Here's how song data that you backed up to CD-R/RW media can be restored to the hard disk of the AW2400.

**1 Insert the CD-R/RW media containing the backup data into the CD-RW drive.**

If the backup data occupies more than one volume of media, insert the first volume.

**2 Call the SONG screen Restore page by either pressing the Work Navigate section [SONG] key as many times as necessary, or by pressing the [F4] key after pressing the [SONG] key.**

In this page, song data that you backed up to CD-R/RW media can be restored to the internal hard disk.

**3 Make sure that the cursor is located at the READ CD INFO button, and press the [ENTER] key.**

Information will be read from the inserted CD-R/RW media. When the information has been read, a display like the following will appear.

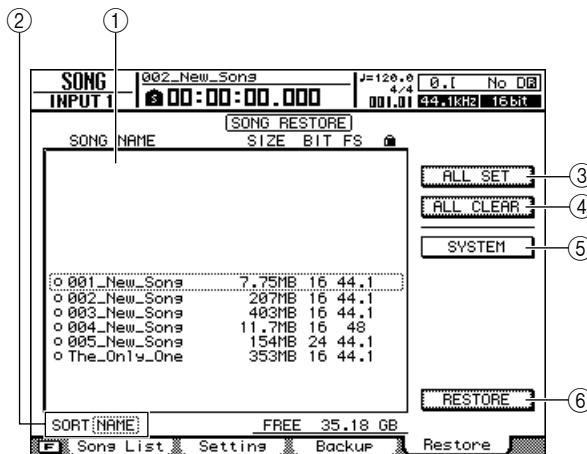

This page contains the following items.

① **List**

This area lists the data that has been backed up on the CD-R/RW media. The symbols at the right of the list indicate whether an item of data has been selected (●) or disabled (○) for restore.



- The maximum number of songs that can be displayed is 100.

② **SORT box**

Changes the order of the songs displayed in the song list. Operation is the same as for the Song List page (→ p. 170).

③ **ALL SET button**

Move the cursor to this button and press the [ENTER] key to select all songs in the list to be restored. Pressing the [F1] key while holding the Display section [SHIFT] key has the same affect as the ALL SET button.

④ **ALL CLEAR button**

Move the cursor to this button and press the [ENTER] key to deselect all songs so that they won't be restored. Pressing the [F2] key while holding the Display section [SHIFT] key has the same affect as the ALL CLEAR button.

⑤ **SYSTEM button**

Selects the system data (AW2400 settings you make in the UTILITY screen) for restoring.

⑥ **RESTORE button**

Restores of the selected song(s). Pressing the [F4] key while holding the Display section [SHIFT] key has the same affect as the RESTORE button.

**4 Make sure the cursor is in the list area, use the [DATA/JOG] dial to select the song you want to restore, then press the [ENTER] key.**

The symbol at the right will change to the (●) symbol, indicating that this song data has been selected for restoring.

If you turn on the ALL SET button, all data shown in the list will be selected in one step.

**5 If you want to restore the system data, move the cursor to the SYSTEM button and press the [ENTER] key.**

The button will be turned on, and the system data will be selected for restoring.

**6 To execute the restore operation, move the cursor to the RESTORE button and press the [ENTER] key.**

A popup window will ask you to confirm the operation.



**7 Move the cursor to the OK button if you want to execute the restore operation (or to the CANCEL button if you decide not to restore), and press the [ENTER] key.**

The current song will be saved automatically, and the restore operation will begin.

A popup window will indicate the progress of the restore operation. When the operation is finished, you will return to step 3.

If the backup occupied more than one CD-R/RW disc, a message of "Exchange Next Media #XXX" (where XXX is a number) will be displayed during the restore process. Exchange the CD-R/RW media for the media of the corresponding number. Then move the cursor to the OK button and press the [ENTER] key.



- When a song with the same name already exists, the name of the restored song will automatically be changed. For example, if "001\_Song" already exists, the song name will be altered as in: "001\_Song0", "001\_Song1" ... etc.

## Exchanging Song Data With Other AW-series Audio Workstations

You can back up an AW2400 song in a format that is compatible with the other AW-series (AW4416/AW2816/AW1600/AW16G). Conversely, a song that was backed up by the other AW-series can be restored into the AW2400.

### NOTE

- Only the audio data recorded in a song can be exchanged with the other AW-series workstations. Mix parameters, libraries, and system data cannot be backed-up/restored in this way.

### ■ Backing up an AW2400 song in a format compatible with the other AW-series

If you turn on the AW2816 button in the Backup page of the SONG screen, the data will be saved in the AW2816 backup file format.

An AW2816 backup file can be restored into the other AW-series (version 2.0 or later for AW4416). For the procedure, refer to “Backing up songs,” earlier in this manual.

### NOTE

- Backup in the AW2816 backup file format is limited to one song at a time.
- When you perform a backup in the AW2816 backup file format, data other than the audio tracks will not be backed up. All virtual tracks for tracks 1–16 are backup up. Tracks 17–24 are not backed up. Only the current track data for stereo track is backed up. Only 44.1kHz/16-bit songs are supported.
- Depending on the data size, some songs can't be saved as AW2816 backup files. If this problem occurs use the Optimize function to reduce the data size.

### ■ Restoring songs from other AW-series workstations

- 1 Insert the CD-R/RW media containing songs from other AW-series workstations to be restored into the AW2400.
- 2 Call the SONG screen Restore page by either pressing the Work Navigate section [SONG] key as many times as necessary, or by pressing the [F4] key after pressing the [SONG] key.
- 3 Make sure that the cursor is located at the READ CD INFO button, and press the [ENTER] key.  
Information will be read from the inserted CD-R/RW media.
- 4 Make sure the cursor is in the list area, use the [DATA/JOG] dial to select the song you want to restore, then press the [ENTER] key.

A “●” mark will appear for songs selected to be restored.

### NOTE

- The list will show all the songs that were backed up to CD-R/RW media, but you can execute the restore operation only for 44.1 kHz/16-bit songs.

- 5 Repeat step 4 to select all of the other AW-series songs that you want to restore.
- 6 Move the cursor to the RESTORE button and press the [ENTER] key.  
A popup window will ask you to confirm the operation.
- 7 Move the cursor to the OK button if you want to execute the restore operation, and press the [ENTER] key.  
The restore operation will begin. While the song data is being loaded, a popup window will indicate the progress.

# ◆ Chapter 19 ◆

## Automix

Operation of the AW2400 Automix features is described below.

### About Automix

Automix allows operations such as fader moves and [ON] switch state changes to be recorded and played back in real time. For example, you can record complex mixdown/bounce operations using Automix so that they can be precisely reproduced as many times as necessary. The parameters that can be recorded by Automix are as follows.

- Fader operation for each channel
- EQ operation for each channel
- [ON] key operation for each channel
- AUX and effect send operation for each channel
- Pan operation for each channel
- Scene and library recall operations

When recording to Automix you can break complex operations down and record them channel by channel or parameter by parameter in several takes, and even “punch in/out” so you can record just a specified region of a song. Furthermore, the recorded Automix data can be displayed in a list and edited for precise control.

Up to 16 Automix sequences can be recorded in a dedicated library and recalled whenever needed. The current Automix data as well as the Library contents are saved independently with each AW2400 song.

### Automix Operation

Automix operation is carried out from the AUTOMIX screen Automix page.

To call this page press the SCENE/AUTOMIX/USB section [AUTOMIX] key as many times as necessary, or press the [F1] key after pressing the [AUTOMIX] key. This page contains the following items.

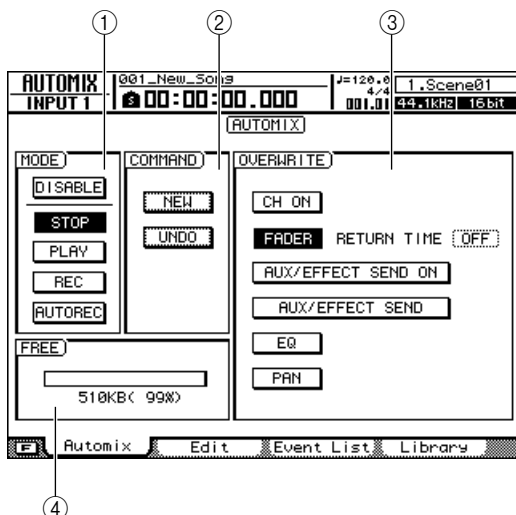

#### ① MODE field

Turns Automix on or off, as well as switching between the record and playback modes.

- **ENABLE/DISABLE button** ..... Enables or disables Automix.
- **STOP button** ..... Stops Automix recording or playback (does not affect recorder operation). Appears inverted when Automix is stopped.
- **PLAY button** ..... While the recorder section is running and Automix recording/playback is stopped, pressing this button after pressing the REC button engages the Automix record standby mode. Appears inverted during Automix recording and playback.

- **REC button** .....Turning this button on while the recorder section is stopped engages the Automix record standby mode. When the recorder section is running it is necessary to press the PLAY button after the REC button to engage the Automix record standby mode. This button is automatically disengaged when recording is completed.
- **AUTOREC button** .....Engages the Automix record standby mode. Unlike the REC button, this button remains engaged after recording is completed and the record standby mode will remain engaged until it is manually turned off.

**HINT** →

• Pressing the [F1]–[F4] keys while holding the Display section [SHIFT] key has the same effect as the ENABLE/DISABLE ([F1] key), STOP ([F2] key), PLAY ([F3] key), and REC ([F4] key) buttons, respectively.

**② COMMAND field**

Allows creation of a new Automix recording, and provides an undo function.

- **NEW button**.....Clears the current Automix data to make way for a new Automix recording.
- **UNDO button** .....Clears the last recorded Automix data, returning to the state immediately before the last Automix recording pass.

**③ OVERWRITE field**

Selects the parameters to be recorded (or overwritten) by Automix recording.

The buttons correspond to the parameters as follows.

- **CH ON button** .....[ON] key operation for each channel
- **FADER button** .....Fader operation for each channel
- **AUX/EFFECT SEND ON button** .....AUX and effect send operation for each channel (mute on/off)
- **AUX/EFFECT SEND button** .....AUX and effect send level operation for each channel
- **EQ button**.....EQ operation for each channel
- **PAN button**.....Pan operation for each channel

**HINT** →

• Using the RETURN TIME field to the right of the FADER button you can specify how long it will take the faders to return to their original positions when Automix recording is stopped or punched out (→ p. 185).

• Scene and library recall operations are always recorded, regardless of the OVERWRITE field settings.

**④ FREE**

Displays the amount of free Automix memory available in kilobytes (KB) and as a percentage.

## Creating a New Automix Recording

A new Automix recording must be created before actual Automix recording can occur.

**NOTE**

• The contents of the current Automix recording will be erased when a new Automix recording is created. To save the current Automix data refer to “Automix Library Operation” on page 190.

**1 Use the channel faders, pan controls, EQ, etc., to set up the mix at the beginning of the current song, and save the mix as a scene.**

The saved “initial” scene will serve as the starting point for the Automix recording. To use a different scene as the starting point for the Automix recording, recall the desired scene. Refer to “Scene Memory Operation” on page 159 for details.

**HINT** →

• When a new Automix recording is created, a “recall event” for the last saved or recalled scene is recorded at the very beginning of the Automix recording. This initial scene can be changed later, as described on page 188.

**2 Call the AUTOMIX screen Automix page by either pressing the [AUTOMIX] key as many times as necessary, or by pressing the [F1] key after pressing the [AUTOMIX] key.**

**3 Move the cursor to the NEW button in the COMMAND field and press the [ENTER] key.**

A confirmation popup window for the new Automix recording will appear.



**4 Move the cursor to the OK button and press the [ENTER] key.**

The current Automix data will be erased and a new Automix recording will be created.

Creation of a new Automix recording can be aborted by moving the cursor to the CANCEL button and pressing the [ENTER] key.

## Recording the Automix Data

Here's how to record mix operation data to the newly created Automix recording.

**1** Move the song location to just before the point at which you want to begin recording the Automix data.

**2** Call the AUTOMIX screen Automix page by either pressing the [AUTOMIX] key as many times as necessary, or by pressing the [F1] key after pressing the [AUTOMIX] key.

**3** Move the cursor to the ENABLE/DISABLE button in the MODE field and press the [ENTER] key.

The button will switch to "ENABLE", and Automix operation will be enabled.



**4** Move the cursor to the OVERWRITE field and engage the buttons corresponding to the parameters you want to record.

Use the OVERWRITE field buttons to select the types of data you want to record: CH ON, FADER, AUX/EFFECT SEND ON, AUX EFFECT SEND, EQ, PAN. Parameters corresponding to buttons that are not engaged will not be recorded even if they are operated during Automix recording.

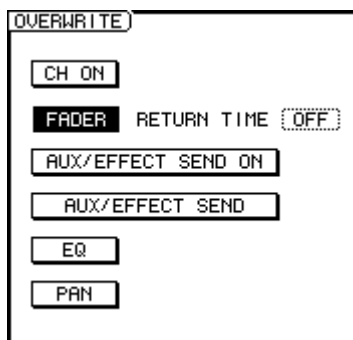

• Scene and library recall operations will be recorded regardless of the OVERWRITE field button selections.

**5** Move the cursor to the MODE field and press the REC button.

The REC button will flash. The Automix record standby mode is now engaged, and the [AUTOMIX] key will flash red.

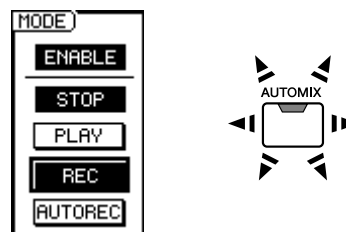

• You can also begin recording after engaging the AUTOREC button rather than the REC button. The REC button is automatically turned off when you stop recording and the record standby mode is disengaged, but the AUTOREC button remains on and the record standby mode remains engaged until it is manually turned off.

**6** Use the Layer section keys to select the mixing layer that includes the channels you want to operate.

For example, to record operations on the track channel faders engage either the Layer section [TRACK 1-12] or [TRACK 13-24] key.



• You can switch mixing layers even after Automix recording has been started.  
• If you plan to record operations performed in the Selected Channel section it is a good idea to select the appropriate parameters before starting recording. For example, if you plan to record pan changes, engage the Selected Channel section [PAN/EQ] key before beginning.

**7** Press the top-panel PLAY [▶] key to start song playback.

The [AUTOMIX] key will light red and Automix recording will begin. But at this point no channel has been selected so no data recording will actually take place.

**8** Use the [INPUT SEL], [SEL], or [STEREO SEL] keys to select the channel for which Automix data is to be recorded.

The selected key will flash orange and the corresponding channel's parameters can be recorded to Automix.



• Multiple channels can be selected for Automix recording.  
• If you press a key that is flashing orange during Automix recording, the key will light continuously and Automix recording for the corresponding channel will be disengaged (punched out). Refer to "Punch In and Out of Automix" on page 185 for details.

## 9 Perform the required mix operations.

The specified mix parameters will be recorded for the specified channel(s).

The parameters specified for recording in step 4 are actually recorded as follows.

### ● CH ON/FADER

Operate the channel [ON] key or fader.

### ● AUX/EFFECT SEND ON

Call the AUX or EFFECT screen, move the cursor to the channel for which AUX or effect send is to be turned on or off, and press the [ENTER] key.

### ● AUX/EFFECT SEND

Call the AUX or EFFECT screen and rotate the appropriate Selected Channel knob, 1–4. Alternatively you can move the cursor to the appropriate on-screen knob and use the [DATA/JOG] dial or [INC]/[DEC] keys to adjust the send level.



- Effect parameter operations can not be recorded to Automix.

### ● EQ

Recall the PAN/EQ screen and use the [LOW], [LOW-MID], [HI-MID], or [HIGH] key to band to be adjusted, then use Selected Channel knobs 2–4 to adjust the selected band as required. Alternatively you can move the cursor to the appropriate knobs in the PAN/EQ screen EQ/Att. page and use the [DATA/JOG] dial or [INC]/[DEC] keys to adjust the EQ. EQ ON/OFF switching is also recorded.



- ATT. knob operation and EQ type selections are not recorded to Automix.

### ● PAN

Recall the PAN/EQ screen and rotate Selected Channel knob 1. Alternatively you can move the cursor to the on-screen knobs and use the [DATA/JOG] dial or [INC]/[DEC] keys to adjust the PAN.



- When making an Automix recording for multiple channels, only the last channel selected can be operated via the Selected Channel controls.
- During Automix recording the [INPUT SEL], [SEL], and [STEREO SEL] keys are used to punch the corresponding channels in or out. The safest way to switch the selected channel during Automix recording is to move the cursor to the appropriate location in the PAN/EQ, EFFECT, or AUX screen.

### ● Scene/Library

Scene, channel, EQ, gate, compressor, and effect setups are recalled via the corresponding library pages.

## 10 When all required mix operations have been recorded, press the top-panel STOP [■] key to stop the song.

The [AUTOMIX] key will go out, the MODE field REC button will be turned off, and the Automix record standby mode will be disengaged. At the same time a popup window asking you to confirm whether you want to update the recorded Automix data will appear.



- Automix recording can be stopped without stopping song playback by moving the cursor to the STOP button in the AUTOMIX screen Automix page and pressing the [ENTER] key (or by pressing the [F2] key while holding the [SHIFT] key).
- If you turn on the AUTOREC button rather than the REC button in step 5, the Automix record standby mode will remain engaged even when song playback is stopped. This method is best when you want to make repeated passes at an Automix recording.

## 11 To confirm and update the recorded data move the cursor to the OK button and press the [ENTER] key.

The recorded Automix data will be updated. You can abort this operation and revert to the previously recorded Automix data by moving the cursor to the CANCEL button rather than the OK button and pressing the [ENTER] key.



- After confirming and updating the recorded Automix data you can still undo the operation and revert to the previously recorded Automix data by moving the cursor to the UNDO button in the COMMAND field and pressing the [ENTER] key. Please note that the top-panel [UNDO] key cannot be used to undo Automix recordings.
- The current Automix data can be stored to the Automix library or a previously stored Automix recording can be recalled from the library. Refer to "Automix Library Operation" on page 190 for details.



## Automix Playback

Playing back an Automix recording.

**1 Call the AUTOMIX screen Automix page by either pressing the [AUTOMIX] key as many times as necessary, or by pressing the [F1] key after pressing the [AUTOMIX] key.**

**2 Make sure that the ENABLE/DISABLE button is set to “ENABLE”.**

If it is set to “DISABLE” move the cursor to the button and press the [ENTER] key. The [AUTOMIX] key will light green.

**3 Press the top-panel PLAY [▶] key to start song playback.**

Automix playback will begin along with song playback. During this time the MODE field PLAY button will appear inverted.



- If playback of a recorded Automix track is started from a point other than the beginning of the track, the mix at that point will be recalled (the parameters immediately prior to the point at which playback was begun will be recalled). This means that you will hear the correct mix no matter where you start playback.

**4 To stop Automix playback press the top-panel STOP [■] key.**

Both song playback and Automix playback will stop. Automix playback will stop automatically if song playback is continued past the point at which Automix recording was stopped (song playback will continue).

## Punch In and Out of Automix

Punch-In/Out recording is handy if you want to re-record just a portion of an Automix recording. The procedure will be described in this section, using re-recording of a track channel fader move as an example.

**1 Locate the song to a point just before you want to begin re-recording the Automix data.**

**2 Call the AUTOMIX screen Automix page by either pressing the [AUTOMIX] key as many times as necessary, or by pressing the [F1] key after pressing the [AUTOMIX] key.**

**3 Make sure that the MODE field ENABLE/DISABLE button is set to “ENABLE”.**

**4 Move the cursor to the OVERWRITE field and engage the buttons corresponding to the parameters you want to record.**



- If you re-record a previously-recorded parameter to the same channel, the previously recorded data for that parameter will be overwritten. If the parameter to be recorded has not already been recorded in the target track, no data will be overwritten.

**5 Set the return time as required by moving the cursor to the RETURN TIME field and using the [DATA/JOG] dial or [INC]/[DEC].**

Return time determines the length of time it will take for the faders to return to the previously-recorded levels after Automix recording has been punched out. The RETURN TIME range is OFF, 0.0–30.0 seconds.

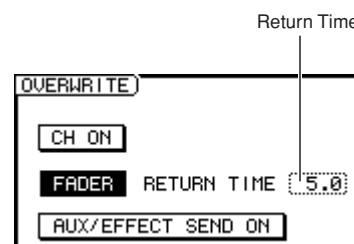

### ● Return Time Operation

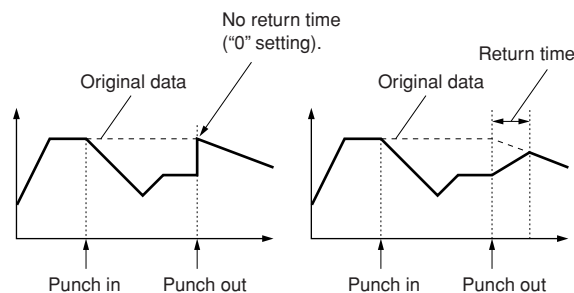

**6 Move the cursor to the MODE field and turn the REC button on.**

The REC button will flash. This engages the Automix record standby mode, and the [AUTOMIX] key will flash red.



- The AUTOREC button can be turned on rather than the REC button to engage the Automix record standby mode.

**7 Use the Layer section keys to select the mixing layer that includes the channels you want to operate.**

**8 Press the top-panel PLAY [▶] key to start song playback.**

The [AUTOMIX] key will light red and Automix recording will begin. But at this point no channel has been selected so no data recording will actually take place.

**9 When the punch-in point is reached use the [INPUT SEL], [SEL], or [STEREO SEL] keys to select the channel for which Automix data is to be recorded.**

The selected key will flash orange and the corresponding channel's parameters can be recorded to Automix.

**10 Operate the fader as required.**



- If no operations are performed between the punch-in and punch-out points all data corresponding to the selected parameter data in the selected channel will be erased. This is a handy way to erase all occurrences of specified data in a specified punch-in/out region.

**11 When the required operations have been performed press the same key that you pressed in step 9.**

The key will go out and Automix recording will stop (punch out). The Automix record mode will remain active, but since no channel is selected no data can actually be recorded (you can press the key again to punch in again and continue recording if desired).



- After punching the fader move in and out, the fader will return to the previously-recorded level at a rate determined by the specified return time.

**12 When all required mix operations have been recorded, press the top-panel STOP [■] key to stop the song.**

A popup window asking you to confirm whether you want to update the recorded Automix data will appear.

**13 To confirm and update the recorded data move the cursor to the OK button and press the [ENTER] key.**

The recorded Automix data will be updated.

## Command Editing Automix data In a Specified Region

This section describes how you can edit specified Automix data within a specified region using commands.

**1 Call the AUTOMIX screen Edit page by either pressing the [AUTOMIX] key as many times as necessary, or by pressing the [F2] key after pressing the [AUTOMIX] key.**

This page contains the following items.

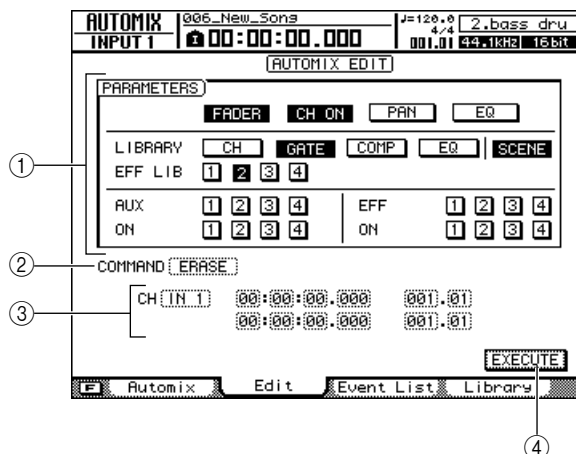

① **PARAMETERS field**

The following parameters can be selected for editing.

- **FADER, CH ON, PAN, EQ buttons**  
.....Faders, Channel [ON] keys, pan, and EQ operations.
- **LIBRARY (CH, GATE, COMP, EQ) buttons**  
.....Channel library (CH), gate library (GATE), compressor library (COMP), and EQ library (EQ) recall.
- **SCENE button** .....Scene recall.
- **EFF LIB 1–4 buttons** .....Effect 1–4 library recall.
- **AUX/ON 1–4 buttons** .....AUX 1–4 send level and on/off switching.
- **EFF/ON 1–4 buttons**.....Effect 1–4 send level and on/off switching.

② **COMMAND**

Displays the currently selected edit command.

③ **Channel/Region**

The channel and region to which the edit command will apply are specified here. The display will change according to the command selected in ②.



- The channel selection will be ignored when editing library, scene or effect settings.

④ **EXECUTE button**

The selected edit command is executed when the cursor is moved to this button and the [ENTER] key is pressed.

**2** Move the cursor to the button in the **PARAMETERS field** corresponding to the parameter to be edited, and press the [ENTER] key.

Multiple parameters can be selected.

**3** Move the cursor to the **COMMAND field** and use the [DATA/JOG] dial or the [INC]/[DEC] keys to select a command, then press the [ENTER] key.

The following commands can be selected.

- **ERASE**..... Erase all occurrences of the specified parameter(s) in the specified region.
- **COPY**..... Copy all occurrences of the specified parameter(s) in the specified region to the specified position in the specified destination channel.
- **MOVE**..... Move all occurrences of the specified parameter(s) in the specified region to the specified position in the specified destination channel. The original parameters will be erased.

The display will change according to the selected edit command as follows.

● **When the ERASE command is selected:**

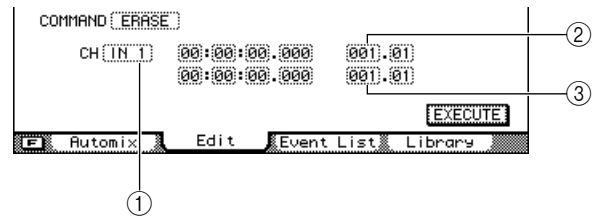

① **The target channel can be selected from the following.**

- **IN 1–16** ..... Input channels 1–16
- **TR 1–24** ..... Track channels 1–24
- **RTN 1–4**..... Effect return channels 1–4
- **BUS 1, 2** ..... Bus master channels 1, 2
- **AUX 1–4**..... AUX send master channels 1–4
- **EFF 1–4** ..... Effect send master channels 1–4
- **ST** ..... Stereo output channel
- **ALL** ..... All channels

② **The start point of the region to be edited is specified in counter format.**

③ **The end point of the region to be edited is specified in counter format.**

● **When the COPY or MOVE command is selected:**

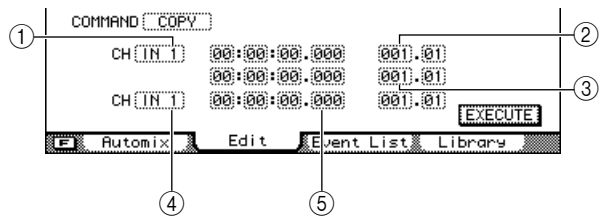

① **Specifies the source channel for the copy or move operation.**

The channels that can be selected are the same as for ERASE, above.

② **The start point of the source region for the copy or move operation specified in counter format.**

③ **The end point of the source region for the copy or move operation is specified in counter format.**

④ **Specifies the destination channel for the copy or move operation.**

Depending on the source channel for copy or move operation, the channels that can be selected vary.

⑤ **The start point of the destination region for the copy or move operation specified in counter format.**

**4** Move the cursor to the appropriate fields and use the [DATA/JOG] dial or [INC]/[DEC] keys to selected the channel and/or region.

**5** Move the cursor to the EXECUTE button, and press the [ENTER] key.

A popup window will ask you to confirm the operation.



**6** Move the cursor to the OK button to execute the command, or move the cursor to the CANCEL button to cancel without executing. Then press the [ENTER] key.

## Editing Individual Automix Events

Individual Automix events can be moved, erased, or value-edited via an Automix event list.

**1** Call the AUTOMIX screen Event List page by either pressing the [AUTOMIX] key as many times as necessary, or by pressing the [F3] key after pressing the [AUTOMIX] key.

This page contains the following items.

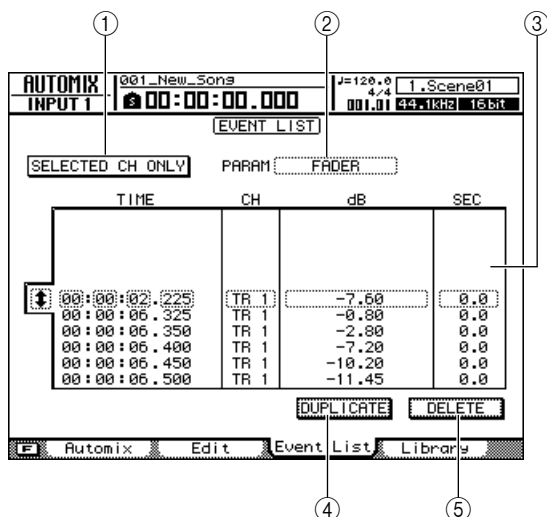

**① SELECTED CH ONLY button**

When this button is engaged only events in the currently selected channel are shown in the list.

**② PARAM**

Selects the type of parameters to be shown in the event list.

**③ Event list**

Individual events of the parameter type selected in the PARAM field are shown in the event list. The event enclosed by a dotted frame is currently selected for editing.

Move the cursor to the icon to the left of the list and use the [DATA/JOG] dial or [INC]/[DEC] keys to scroll through the event list.

**④ DUPLICATE button**

Move the cursor to this button and press the [ENTER] key to create a duplicate of the selected event at the same location.

**⑤ DELETE button**

Move the cursor to this button and press the [ENTER] key to delete the selected event.

**2** To display only events in a specific channel, move the cursor to the **SELECTED CH ONLY** button and press the **[ENTER]** key, then select the desired channel.

**3** Move the cursor to the **PARAM** field and press the **[ENTER]** key to select the type of parameter to be displayed in the event list.

The available parameter types are as follows.

Display	Parameter
SCENE/LIB	Scene/library recall
FADER	Fader operation
ON	[ON] key operation
PAN	Pan operation
AUX/EFF	AUX/effect send operation
AUX/EFF ON	AUX/effect on/off
EQ (ON)	EQ on/off
EQ (FREQ)	EQ center frequency
EQ (Q)	EQ bandwidth
EQ (GAIN)	EQ gain

**4** Use the **[DATA/JOG]** dial or **[INC]/[DEC]** keys to select the type of parameter to be displayed in the list, then press the **[ENTER]** key.

The specified events will appear in the event list.

**5** Move the cursor to the  icon to the left of the list and use the **[DATA/JOG]** dial or **[INC]/[DEC]** keys to scroll through the event list and select the event to be edited.

The event enclosed by a dotted frame is currently selected for editing.

**HINT** 

- The cursor can be quickly moved to the  icon by pressing the **[F1]** key while holding the Display section **[SHIFT]** key.
- When the cursor is inside the event list the cursor keys can also be used to scroll up and down the event list.

Items that can be edited in the event list are as follows.

① TIME	② CH	③ dB	SEC
00:00:03.925	TR 1	-1.75	0.0
00:00:03.950	TR 1	-4.65	0.0
00:00:03.975	TR 1	-7.00	0.0
00:00:04.000	TR 1	-9.45	0.0
00:00:04.025	TR 1	-12.00	0.0
00:00:04.050	TR 1	-14.75	0.0
00:00:04.075	TR 1	-17.95	0.0
00:00:04.100	TR 1	-21.90	0.0
00:00:04.125	TR 1	-28.00	0.0
00:00:04.150	TR 1	-41.00	0.0
00:00:04.175	TR 1	-∞	0.0

**① TIME**

Specifies the position of the event.

**② CH**

Specifies the channel to which the event will apply.

**③ Value**

Edits the value of the event type specified in the PARAM field.

Parameter	Value (Display)	Description
SCENE	SCENE/LIB	Scene/library type and scene/library number
FADER	dB, SEC	Fader level, return time
ON	ON/OFF	Channel on/off status
PAN	L-C-R	L63 (full left)–C (center)–R63 (full right)
AUX/EFF	AUX/EFF, dB	AUX/effect type and send level
AUX/EFF ON	AUX/EFF, ON/OFF	AUX/effect type and on/off status
EQ (ON)	ON/OFF	EQ on/off status
EQ (FREQ)	Hz	EQ center frequency
EQ (Q)	Q	EQ bandwidth
EQ (GAIN)	dB	Level of the operated band

**6** Move the cursor to the appropriate item in the even list. Use the **[DATA/JOG]** dial or **[INC]/[DEC]** keys to set the value as required, then press the **[ENTER]** key.

The edited data will change immediately.

**7** When you want to add a new event, first move the cursor to the **DUPLICATE** button and press the **[ENTER]** key.

A copy of the currently selected event will be created at the same location. You can then edit the time, channel, or value as required.

**HINT** 

- Pressing the **[F2]** key while holding the Display section **[SHIFT]** key has the same effect as the **DUPLICATE** button.

**8** To delete an unneeded event move the cursor to the **DELETE** button and press the **[ENTER]** key.

The currently selected event will be deleted.

**HINT** 

- Pressing the **[F3]** key while holding the Display section **[SHIFT]** key has the same effect as the **DELETE** button.

# Automix Library Operation

Automix data can be stored to a specialized Automix library and recalled whenever needed. Up to 16 Automix recordings can be saved for each song, so you can easily create and compare multiple mixes for the same song.

## About the Automix Library Page

Automix data can be saved to and recalled from the Automix library via the AUTOMIX screen Library page. To call this page press the SCENE/AUTOMIX/USB section [AUTOMIX] key as many times as necessary, or press the [F4] key after pressing the [AUTOMIX] key. This page contains the following items.

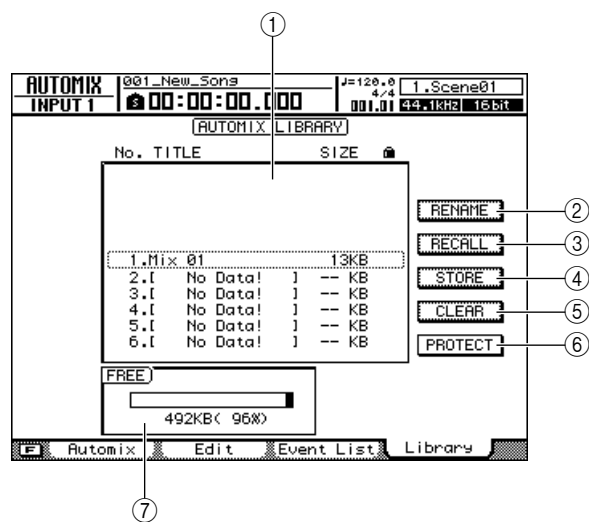

- ① **List**  
A list of all the Automix data stored in the library. The Automix data enclosed in a dotted frame is the one currently selected for operation. A “lock” icon indicates protected Automix data.
- ② **RENAME button**  
Accesses the NAME EDIT popup window, where you can edit the name of the Automix selected in the list.
- ③ **RECALL button**  
Recalls the Automix data that is selected in the list.
- ④ **STORE button**  
Stores the current Automix settings into the location selected in the list.
- ⑤ **CLEAR button**  
Deletes the Automix data that is selected in the list.
- ⑥ **PROTECT**  
Applies protection to the Automix data that is selected in the list.
- ⑦ **FREE**  
Displays the amount of free Automix memory available in kilobytes (KB), as a percentage, and as a graph.

## Changing Automix Names

Here’s how you can change the names of the data in the Automix library.

**1** Call the AUTOMIX screen Library page by either pressing the [AUTOMIX] key as many times as necessary, or by pressing the [F4] key after pressing the [AUTOMIX] key.

**2** Use the [DATA/JOG] dial or [INC]/[DEC] keys to select the Automix data to be edited.

The data highlighted by a dotted frame is currently selected for editing.

**3** Move the cursor to the RENAME button and press the [ENTER] key.

The NAME EDIT popup window will appear.



• Pressing the [F4] key while holding the Display section [SHIFT] key has the same effect as the RENAME button.

**4** Enter a name for the selected Automix data, move the cursor to the OK button, and press the [ENTER] key (refer to page 32 for details on name entry).

This confirms and enters the new name.

## Storing Automix settings

Storing the current Automix data to the Automix library.



- If you select and store to a library number that contains previously-stored data, the previous data will be overwritten.

**1** Call the AUTOMIX screen Library page by either pressing the [AUTOMIX] key as many times as necessary, or by pressing the [F4] key after pressing the [AUTOMIX] key.

**2** Use the [DATA/JOG] dial or [INC]/[DEC] keys to select the library number to which the data is to be stored.

The data highlighted by a dotted frame is currently selected for storage.

**3** Move the cursor to the STORE button and press the [ENTER] key.

The NAME EDIT popup window will appear.



- Pressing the [F2] key while holding the Display section [SHIFT] key has the same effect as the STORE button.

**4** As required, enter a name for the selected Automix data, move the cursor to the OK button, and press the [ENTER] key (refer to page 32 for details on name entry).

The automix setting will be stored.

## Recalling Automix settings

Recalling stored Automix data from the library.

**1** Call the AUTOMIX screen Library page by either pressing the [AUTOMIX] key as many times as necessary, or by pressing the [F4] key after pressing the [AUTOMIX] key.

**2** Use the [DATA/JOG] dial or [INC]/[DEC] keys to select the library data to be recalled.

The data highlighted by a dotted frame is currently selected for recall.

**3** Move the cursor to the RECALL button and press the [ENTER] key.

A popup window confirming the recall operation will appear.



- Pressing the [F1] key while holding the Display section [SHIFT] key has the same effect as the RECALL button.

**4** To actually recall the selected data move the cursor to the OK button and press the [ENTER] key.

The library data will be recalled.

## Erasing Automix settings

Erasing unneeded Automix data from the library.



- Erased Automix data cannot be recovered. Use this function with caution.

**1** Call the AUTOMIX screen Library page by either pressing the [AUTOMIX] key as many times as necessary, or by pressing the [F4] key after pressing the [AUTOMIX] key.

**2** Use the [DATA/JOG] dial or [INC]/[DEC] keys to select the Automix data to be erased.

The data highlighted by a dotted frame is currently selected to be erased.

**3** Move the cursor to the CLEAR button and press the [ENTER] key.

A popup window confirming the clear operation will appear.



- Pressing the [F3] key while holding the Display section [SHIFT] key has the same effect as the CLEAR button.

**4** To actually erase the selected data move the cursor to the OK button and press the [ENTER] key.

## Protecting Automix Data

Applying protection to Automix data to prevent accidental erasure.

**1 Call the AUTOMIX screen Library page by either pressing the [AUTOMIX] key as many times as necessary, or by pressing the [F4] key after pressing the [AUTOMIX] key.**

**2 Use the [DATA/JOG] dial or [INC]/[DEC] keys to select the Automix data to be protected.**

The data highlighted by a dotted frame is currently selected for operation.

**3 Move the cursor to the PROTECT button and press the [ENTER] key.**

When protection is turned on the PROTECT button will appear inverted and a lock icon will appear to the right of the Automix name.



# ◆ Chapter 20 ◆

## MIDI

This section will describe the basic MIDI settings as well as the various MIDI features and capabilities provided.

### What you can do using MIDI

On the AW2400, you can use MIDI to do the following things.

- **Synchronize operation with an external device**

You can synchronize an AW2400 song with playback of an external device (such as a MIDI sequencer) by exchanging synchronization messages such as MTC (MIDI Time Code) or MIDI Clock with the external device.

- **Remote control of AW2400 transport functions**

You can transmit MMC (MIDI Machine Control) messages from a MIDI sequencer or other external MIDI device to the AW2400 to remotely control the AW2400's transport functions. Conversely, you can also transmit MMC from the AW2400 to an external device for remote transport control.

- **Example: using MTC/MMC to synchronize the operation of the AW2400 and a MIDI sequencer (computer).**

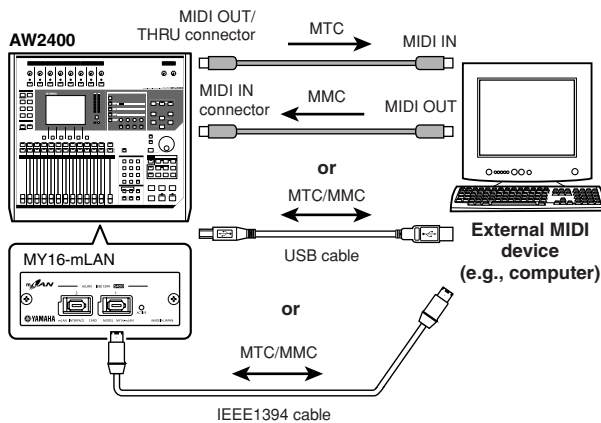

- **Automate scene changes and mix parameters**

When you recall a scene on the AW2400 or operate its mix parameters, the corresponding messages (program change or control change) can be transmitted to an external device.

If you record these messages on a MIDI sequencer that is synchronized to the AW2400, the scene recall operations or mix parameter operations can be precisely reproduced at any time.

- **Example: recording/playing scene selections and mix parameter operations on a MIDI sequencer (computer)**

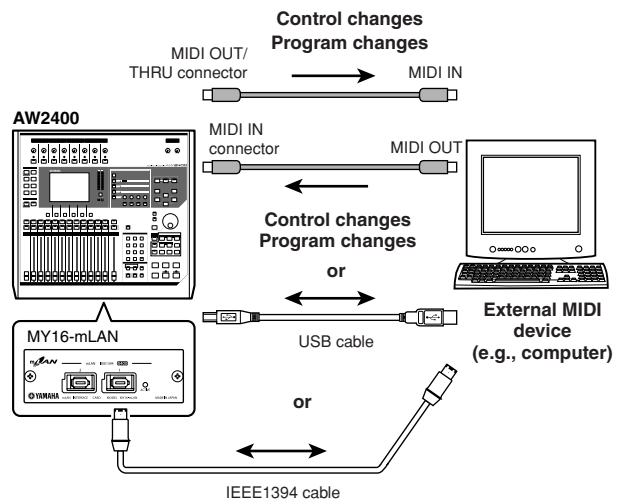

- **MIDI Remote**

"MIDI Remote" is a function that lets you use the AW2400 as a physical controller for an external device. You can assign the desired MIDI messages to the top-panel faders and [ON] keys, and use them to remotely control a MIDI device or computer program.

- **Example: using the AW2400 as a physical controller for a MIDI sound module**

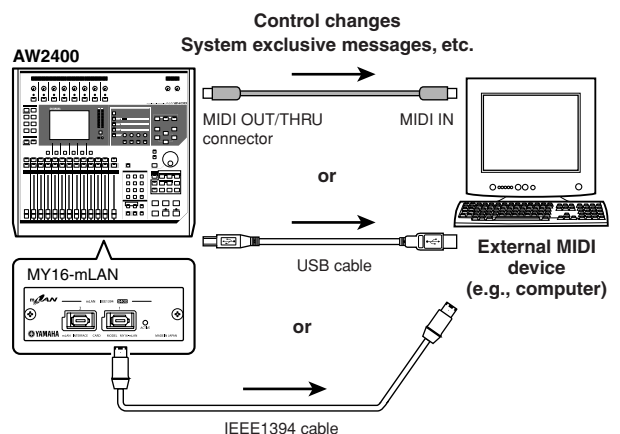

# Basic MIDI Settings

The MIDI screen Setting 1 page lets you specify the connector/port to be used for MIDI message transmission and reception to and from external MIDI devices.

To call this page press the Work Navigate section [MIDI] key as many times as necessary, or press the [F1] key after pressing the [MIDI] key.

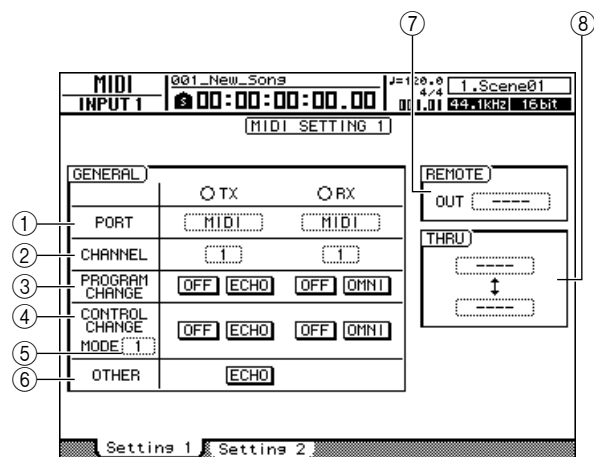

This page contains the following items.

### ① PORT field

Selects the connector(s)/port(s) to be used for MIDI message transmission and reception. Press the [ENTER] key to confirm your selection.

The connectors/ports that can be selected for MIDI transmission (TX) and reception (RX) are as follows:

Items	TX (Transmission)	RX (Reception)
MIDI	[MIDI OUT/THRU] connector	[MIDI IN] connector
USB 1	USB connector output port 1	USB connector input port 1
USB 2	USB connector output port 2	USB connector input port 2
USB 3	USB connector output port 3	USB connector input port 3
SLOT	Digital I/O card output port	Digital I/O card output port

#### NOTE

- It may be necessary to install an appropriate USB MIDI driver in order to use the USB connector for MIDI communication on computers (→ p. 266).
- To connect to a computer using the MY16-mLAN digital I/O card, install the MY16-mLAN card in the digital I/O slot and select "SLOT". The appropriate mLAN driver must be installed on the computer.

### ② CHANNEL field

Selects the MIDI channel that will be used to transmit and receive MIDI messages such as program changes and control changes. This area contains the following two items.

- **TX** ..... Selects the transmit MIDI channel, in a range of 1–16.
- **RX** ..... Selects the receive MIDI channel, in a range of 1–16.

### ③ PROGRAM CHANGE field

Turns program change transmission and reception on or off. When program change reception is on, the corresponding scene will be recalled when a program change message is received via the AW2400 MIDI IN connector (or USB connector or digital I/O card input port). When program change transmission is on, when a scene is recalled on the AW2400 the corresponding program change message is transmitted via the MIDI OUT/THRU connector (or USB connector or digital I/O card output port).

The following items are available:

- **ON/OFF button (TX)** ..... Turns program change transmission on or off.
- **ECHO button (TX)** ..... Received program change messages are re-transmitted ("echoed") via the MIDI OUT/THRU connector (or USB connector or digital I/O card output port).
- **ON/OFF button (RX)** ..... Turns program change reception on or off.
- **OMNI button (RX)** ..... Program change messages can be received on all MIDI channels, regardless of the MIDI receive channel setting.

#### HINT

- In the SCENE screen PGM Assign page you can specify the scene number that will correspond to each program change number (→ p. 201).

### ④ CONTROL CHANGE field

Specifies how MIDI control change messages will be transmitted and received. If control change transmission and reception are enabled, the corresponding control change message will be transmitted when you operate any of the AW2400's channel mix parameters (fader, pan, effect send, etc.). When a control change message is received, the corresponding AW2400 mix parameter will change.

The following items are available:

- **ON/OFF button (TX)** ..... Turns control change transmission on or off.
- **ECHO button (TX)** ..... Received control change messages are re-transmitted ("echoed") via the MIDI OUT/THRU connector (or USB connector or digital I/O card output port).
- **ON/OFF button (RX)** ..... Turns control change reception on or off.
- **OMNI button (RX)** ..... Control change messages can be received on all MIDI channels, regardless of the MIDI receive channel setting.

⑤ **CONTROL CHANGE MODE box**

Selects the channels via which MIDI control change messages will be transmitted and received. The following choices are available:

- **1** ..... Control change messages will be transmitted and received on MIDI channels 1–16. (MIDI channels 1–16 will correspond to AW2400 track channels 1–16.)
- **2** ..... Control change messages will be transmitted and received only on the MIDI channel that is selected in the CHANNEL field.
- **3** ..... This is the same as 2 in that control change messages are only received and transmitted via one MIDI channel, but the parameter mapping differs from 2.



• For details on the mix parameters that correspond to each control change message, refer to the tables that follow.

● **When CONTROL CHANGE MODE = 1**

MIDI CH	CC#	PARAMETER	
1	7	TRACK CHANNEL 1	FADER
	10		PAN
	91		EFF1 SEND
	93		EFF2 SEND
2	7	TRACK CHANNEL 2	FADER
	10		PAN
	91		EFF1 SEND
	93		EFF2 SEND
3	7	TRACK CHANNEL 3	FADER
	10		PAN
	91		EFF1 SEND
	93		EFF2 SEND
4	7	TRACK CHANNEL 4	FADER
	10		PAN
	91		EFF1 SEND
	93		EFF2 SEND
5	7	TRACK CHANNEL 5	FADER
	10		PAN
	91		EFF1 SEND
	93		EFF2 SEND
6	7	TRACK CHANNEL 6	FADER
	10		PAN
	91		EFF1 SEND
	93		EFF2 SEND
7	7	TRACK CHANNEL 7	FADER
	10		PAN
	91		EFF1 SEND
	93		EFF2 SEND
8	7	TRACK CHANNEL 8	FADER
	10		PAN
	91		EFF1 SEND
	93		EFF2 SEND

MIDI CH	CC#	PARAMETER	
9	7	TRACK CHANNEL 9	FADER
	10		PAN
	91		EFF1 SEND
	93		EFF2 SEND
10	7	TRACK CHANNEL 10	FADER
	10		PAN
	91		EFF1 SEND
	93		EFF2 SEND
11	7	TRACK CHANNEL 11	FADER
	10		PAN
	91		EFF1 SEND
	93		EFF2 SEND
12	7	TRACK CHANNEL 12	FADER
	10		PAN
	91		EFF1 SEND
	93		EFF2 SEND
13	7	TRACK CHANNEL 13	FADER
	10		PAN
	91		EFF1 SEND
	93		EFF2 SEND
14	7	TRACK CHANNEL 14	FADER
	10		PAN
	91		EFF1 SEND
	93		EFF2 SEND
15	7	TRACK CHANNEL 15	FADER
	10		PAN
	91		EFF1 SEND
	93		EFF2 SEND
16	7	TRACK CHANNEL 16	FADER
	10		PAN
	91		EFF1 SEND
	93		EFF2 SEND

● When CONTROL CHANGE MODE = 2

CC#	PARAMETER		
0			NO ASSIGN
1	FADER	CHANNEL	INPUT 1
2	FADER	CHANNEL	INPUT 2
3	FADER	CHANNEL	INPUT 3
4	FADER	CHANNEL	INPUT 4
5	FADER	CHANNEL	INPUT 5
6	FADER	CHANNEL	INPUT 6
7	FADER	CHANNEL	INPUT 7
8	FADER	CHANNEL	INPUT 8
9	FADER	CHANNEL	INPUT 9
10	FADER	CHANNEL	INPUT 10
11	FADER	CHANNEL	INPUT 11
12	FADER	CHANNEL	INPUT 12
13	FADER	CHANNEL	INPUT 13
14	FADER	CHANNEL	INPUT 14
15	FADER	CHANNEL	INPUT 15
16	FADER	CHANNEL	INPUT 16
17			NO ASSIGN
18			NO ASSIGN
19			NO ASSIGN
20			NO ASSIGN
21	FADER	CHANNEL	RETURN 1
22	FADER	CHANNEL	RETURN 2
23	FADER	MASTER	STEREO OUT
24	FADER	MASTER	AUX 1
25	FADER	MASTER	AUX 2
26	FADER	MASTER	AUX 3
27	FADER	MASTER	AUX 4
28	FADER	MASTER	EFF 1
29	FADER	MASTER	EFF 2
30	FADER	MASTER	EFF 3
31	FADER	MASTER	EFF 4
32			NO ASSIGN
33	FADER	MASTER	BUS 1
34	FADER	MASTER	BUS 2
35			NO ASSIGN
36			NO ASSIGN
37			NO ASSIGN
38			NO ASSIGN
39			NO ASSIGN
40			NO ASSIGN
41	ON	CHANNEL	INPUT 1
42	ON	CHANNEL	INPUT 2
43	ON	CHANNEL	INPUT 3
44	ON	CHANNEL	INPUT 4
45	ON	CHANNEL	INPUT 5
46	ON	CHANNEL	INPUT 6
47	ON	CHANNEL	INPUT 7
48	ON	CHANNEL	INPUT 8
49	ON	CHANNEL	INPUT 9
50	ON	CHANNEL	INPUT 10
51	ON	CHANNEL	INPUT 11
52	ON	CHANNEL	INPUT 12
53	ON	CHANNEL	INPUT 13
54	ON	CHANNEL	INPUT 14
55	ON	CHANNEL	INPUT 15
56	ON	CHANNEL	INPUT 16
57			NO ASSIGN
58			NO ASSIGN
59			NO ASSIGN
60			NO ASSIGN
61	ON	CHANNEL	RETURN 1
62	ON	CHANNEL	RETURN 2
63	ON	MASTER	STEREO OUT

CC#	PARAMETER		
64	PAN	CHANNEL	INPUT 1
65	PAN	CHANNEL	INPUT 2
66	PAN	CHANNEL	INPUT 3
67	PAN	CHANNEL	INPUT 4
68	PAN	CHANNEL	INPUT 5
69	PAN	CHANNEL	INPUT 6
70	PAN	CHANNEL	INPUT 7
71	PAN	CHANNEL	INPUT 8
72	PAN	CHANNEL	INPUT 9
73	PAN	CHANNEL	INPUT 10
74	PAN	CHANNEL	INPUT 11
75	PAN	CHANNEL	INPUT 12
76	PAN	CHANNEL	INPUT 13
77	PAN	CHANNEL	INPUT 14
78	PAN	CHANNEL	INPUT 15
79	PAN	CHANNEL	INPUT 16
80			NO ASSIGN
81			NO ASSIGN
82			NO ASSIGN
83			NO ASSIGN
84			NO ASSIGN
85			NO ASSIGN
86			NO ASSIGN
87			NO ASSIGN
88	PAN	CHANNEL	RETURN 1L
89	PAN	CHANNEL	RETURN 1R
90	PAN	CHANNEL	RETURN 2L
91	PAN	CHANNEL	RETURN 2R
92	PAN	BALANCE	STEREO OUT
93			NO ASSIGN
94			NO ASSIGN
95			NO ASSIGN
96			NO ASSIGN
97			NO ASSIGN
98			NO ASSIGN
99			NO ASSIGN
100			NO ASSIGN
101			NO ASSIGN
102	FADER	EFF1 SEND	INPUT 1
103	FADER	EFF1 SEND	INPUT 2
104	FADER	EFF1 SEND	INPUT 3
105	FADER	EFF1 SEND	INPUT 4
106	FADER	EFF1 SEND	INPUT 5
107	FADER	EFF1 SEND	INPUT 6
108	FADER	EFF1 SEND	INPUT 7
109	FADER	EFF1 SEND	INPUT 8
110	FADER	EFF1 SEND	INPUT 9
111	FADER	EFF1 SEND	INPUT 10
112	FADER	EFF1 SEND	INPUT 11
113	FADER	EFF1 SEND	INPUT 12
114	FADER	EFF1 SEND	INPUT 13
115	FADER	EFF1 SEND	INPUT 14
116	FADER	EFF1 SEND	INPUT 15
117	FADER	EFF1 SEND	INPUT 16
118			NO ASSIGN
119			NO ASSIGN
120			NO ASSIGN
121			NO ASSIGN
122			NO ASSIGN
123			NO ASSIGN
124			NO ASSIGN
125			NO ASSIGN
126			NO ASSIGN
127			NO ASSIGN

20  
MIDI

● When CONTROL CHANGE MODE = 3

CC#	PARAMETER		
0		NO ASSIGN	
1	FADER	CHANNEL	TRACK 1
2	FADER	CHANNEL	TRACK 2
3	FADER	CHANNEL	TRACK 3
4	FADER	CHANNEL	TRACK 4
5	FADER	CHANNEL	TRACK 5
6	FADER	CHANNEL	TRACK 6
7	FADER	CHANNEL	TRACK 7
8	FADER	CHANNEL	TRACK 8
9	FADER	CHANNEL	TRACK 9
10	FADER	CHANNEL	TRACK 10
11	FADER	CHANNEL	TRACK 11
12	FADER	CHANNEL	TRACK 12
13	FADER	CHANNEL	TRACK 13
14	FADER	CHANNEL	TRACK 14
15	FADER	CHANNEL	TRACK 15
16	FADER	CHANNEL	TRACK 16
17	FADER	CHANNEL	TRACK 17
18	FADER	CHANNEL	TRACK 18
19	FADER	CHANNEL	TRACK 19
20	FADER	CHANNEL	TRACK 20
21	FADER	CHANNEL	RETURN 1
22	FADER	CHANNEL	RETURN 2
23	FADER	MASTER	STEREO OUT
24	FADER	MASTER	AUX 1
25	FADER	MASTER	AUX 2
26	FADER	MASTER	AUX 3
27	FADER	MASTER	AUX 4
28	FADER	MASTER	EFF 1
29	FADER	MASTER	EFF 2
30	FADER	MASTER	EFF 3
31	FADER	MASTER	EFF 4
32		NO ASSIGN	
33	FADER	MASTER	BUS 1
34	FADER	MASTER	BUS 2
35		NO ASSIGN	
36		NO ASSIGN	
37		NO ASSIGN	
38		NO ASSIGN	
39		NO ASSIGN	
40		NO ASSIGN	
41	ON	CHANNEL	TRACK 1
42	ON	CHANNEL	TRACK 2
43	ON	CHANNEL	TRACK 3
44	ON	CHANNEL	TRACK 4
45	ON	CHANNEL	TRACK 5
46	ON	CHANNEL	TRACK 6
47	ON	CHANNEL	TRACK 7
48	ON	CHANNEL	TRACK 8
49	ON	CHANNEL	TRACK 9
50	ON	CHANNEL	TRACK 10
51	ON	CHANNEL	TRACK 11
52	ON	CHANNEL	TRACK 12
53	ON	CHANNEL	TRACK 13
54	ON	CHANNEL	TRACK 14
55	ON	CHANNEL	TRACK 15
56	ON	CHANNEL	TRACK 16
57	ON	CHANNEL	TRACK 17
58	ON	CHANNEL	TRACK 18
59	ON	CHANNEL	TRACK 19
60	ON	CHANNEL	TRACK 20
61	ON	CHANNEL	RETURN 1
62	ON	CHANNEL	RETURN 2
63	ON	MASTER	STEREO OUT

CC#	PARAMETER		
64	PAN	CHANNEL	TRACK 1
65	PAN	CHANNEL	TRACK 2
66	PAN	CHANNEL	TRACK 3
67	PAN	CHANNEL	TRACK 4
68	PAN	CHANNEL	TRACK 5
69	PAN	CHANNEL	TRACK 6
70	PAN	CHANNEL	TRACK 7
71	PAN	CHANNEL	TRACK 8
72	PAN	CHANNEL	TRACK 9
73	PAN	CHANNEL	TRACK 10
74	PAN	CHANNEL	TRACK 11
75	PAN	CHANNEL	TRACK 12
76	PAN	CHANNEL	TRACK 13
77	PAN	CHANNEL	TRACK 14
78	PAN	CHANNEL	TRACK 15
79	PAN	CHANNEL	TRACK 16
80	PAN	CHANNEL	TRACK 17
81	PAN	CHANNEL	TRACK 18
82	PAN	CHANNEL	TRACK 19
83	PAN	CHANNEL	TRACK 20
84	PAN	CHANNEL	TRACK 21
85	PAN	CHANNEL	TRACK 22
86	PAN	CHANNEL	TRACK 23
87	PAN	CHANNEL	TRACK 24
88	PAN	CHANNEL	RETURN 1L
89	PAN	CHANNEL	RETURN 1R
90	PAN	CHANNEL	RETURN 2L
91	PAN	CHANNEL	RETURN 2R
92	PAN	BALANCE	STEREO OUT
93		NO ASSIGN	
94		NO ASSIGN	
95		NO ASSIGN	
96		NO ASSIGN	
97		NO ASSIGN	
98		NO ASSIGN	
99		NO ASSIGN	
100		NO ASSIGN	
101		NO ASSIGN	
102	FADER	EFF1 SEND	TRACK 1
103	FADER	EFF1 SEND	TRACK 2
104	FADER	EFF1 SEND	TRACK 3
105	FADER	EFF1 SEND	TRACK 4
106	FADER	EFF1 SEND	TRACK 5
107	FADER	EFF1 SEND	TRACK 6
108	FADER	EFF1 SEND	TRACK 7
109	FADER	EFF1 SEND	TRACK 8
110	FADER	EFF1 SEND	TRACK 9
111	FADER	EFF1 SEND	TRACK 10
112	FADER	EFF1 SEND	TRACK 11
113	FADER	EFF1 SEND	TRACK 12
114	FADER	EFF1 SEND	TRACK 13
115	FADER	EFF1 SEND	TRACK 14
116	FADER	EFF1 SEND	TRACK 15
117	FADER	EFF1 SEND	TRACK 16
118		NO ASSIGN	
119		NO ASSIGN	
120		NO ASSIGN	
121		NO ASSIGN	
122		NO ASSIGN	
123		NO ASSIGN	
124		NO ASSIGN	
125		NO ASSIGN	
126		NO ASSIGN	
127		NO ASSIGN	

⑥ **OTHER field**

MIDI messages other than program change and control change messages are set up here.

- **ECHO button (TX)**..... Received MIDI messages other than program and control change are re-transmitted (“echoed”) via the MIDI OUT/THRU connector (or USB connector or digital I/O card output port).

⑦ **REMOTE OUT box**

Selects the connector/port via which MIDI messages will be transmitted when the MIDI Remote function is active (when the REMOTE screen is showing). Refer to page 204 for details on the MIDI Remote function.

**NOTE**

- The same connector/port as selected in the PORT field or THRU box cannot be selected here.

⑧ **THRU box**

Specifies the connector/port for “THRU” output of MIDI messages received via the MIDI IN connector (or USB connector or digital I/O card input port). If “MIDI” and “USB 1” are selected for the two THRU boxes, THRU output will be as follows:

- Messages received at the MIDI IN connector will be THRU output via the USB output port 1.
- Messages received at the USB input port 1 will be THRU output via the MIDI OUT/THRU connector.

MIDI messages generated by the AW2400 itself are not transmitted via connectors/ports selected for THRU output.

**NOTE**

- The same connector/port cannot be specified for both boxes.
- The same connector/port as selected in the PORT field or REMOTE OUT box cannot be selected here.

## MIDI Synchronization Message Setup

The MIDI screen Setting 2 page allows selection of MIDI messages used for synchronization with external equipment (MTC and MIDI clock) as well as messages used for remote control.

To call this page press the Work Navigate section [MIDI] key as many times as necessary, or press the [F2] key after pressing the [MIDI] key.

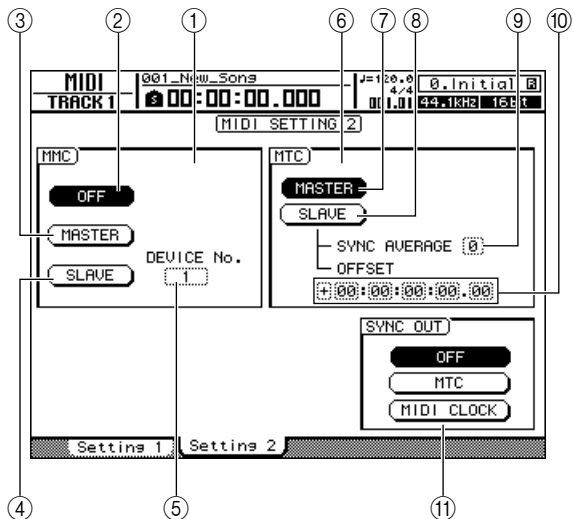

This page contains the following items.

① **MMC field**

Specifies how MMC will be transmitted/received.

② **MMC OFF button**

Engage this button (it will appear inverted) to disable MMC transmission and reception.

③ **MMC MASTER button**

When this button is turned on the AW2400 functions as MMC master, and the appropriate MMC commands will be output via the MIDI OUT/THRU connector (or USB connector or digital I/O card output port) when the transport is operated. Turn this button on when you want to remotely control external equipment from the AW2400.

④ **MMC SLAVE button**

When this button is turned on the AW2400 functions as MMC slave, and will respond to appropriate MMC commands received via the MIDI IN connector (or USB connector or digital I/O card input port). Turn this button on when you want to remotely control the AW2400 from external equipment.

**⑤ DEVICE NO. box**

Specifies the MMC device number (1–127) that the AW2400 will receive.

**NOTE**

- The MMC device number is an identifying number used to distinguish devices that transmit and receive MMC commands. When using MMC, the AW2400 and the external MIDI device must be set to the same MMC device number.
- When transmitting MMC data from the AW2400, the MMC device number is always set to "128" (allowing control of all MMC-compatible devices).

**⑥ MTC field**

Specifies how the AW2400 operates when synchronized with an external MIDI device using MTC (MIDI Time Code).

**⑦ MTC MASTER button**

When this button is on the AW2400 functions as MTC master. Turn this button on when you want external equipment to synchronize to the AW2400.

**⑧ MTC SLAVE button**

When this button is turned on the AW2400 functions as MTC slave, and will follow MTC received via the MIDI IN connector (or USB connector or digital I/O card input port). Turn this button on when you want to synchronize two AW2400 units, or synchronize the AW2400 to an external device that can only function in MTC master mode.

**⑨ SYNC AVERAGE box**

Select one of the following to specify how closely the AW2400 will follow the incoming MTC data when functioning as an MTC slave.

- **0** ..... The AW2400 will synchronize to the incoming MTC data with the highest precision. If the incoming MTC has significant instability, synchronization may be interrupted or become unreliable with this setting.
- **1** ..... This setting provides more tolerance to MTC instability than the OFF setting.
- **2** ..... This setting allows the maximum tolerance. Use this setting if the MTC master is an external MIDI device that has significant instability.

**HINT**

- If the accuracy of the incoming MTC becomes unstable when the AW2400 is functioning as an MTC slave and is synchronized to an external MIDI device, the AW2400 will make slight adjustments in playback pitch in an attempt to maintain synchronization. The SYNC AVERAGE parameter specifies the range of MTC variance that will be tolerated.

**⑩ OFFSET**

When using the AW2400 as an MTC slave, this parameter shifts the absolute time of the AW2400 forward or backward relative to the incoming MTC. The range is -24:00:00:00.00 to +24:00:00:00.00.

**OFFSET = 00:00:00:00.00**

Incoming time code	00:00:10:00.00	00:00:15:00.00	00:00:20:00.00
Time code display (ABS)	00:00:10:00.00	00:00:15:00.00	00:00:20:00.00
Song			

**OFFSET = +00:00:05:00.00**

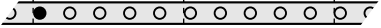
Incoming time code	00:00:10:00.00	00:00:15:00.00	00:00:20:00.00
Time code display (ABS)	00:00:15:00.00	00:00:20:00.00	00:00:25:00.00
Song			

**OFFSET = -00:00:05:00.00**

Incoming time code	00:00:10:00.00	00:00:15:00.00	00:00:20:00.00
Time code display (ABS)	00:00:05:00.00	00:00:10:00.00	00:00:15:00.00
Song			

**HINT**

- The OFFSET setting has no effect on MTC output via the MIDI OUT/THRU connector (or USB connector or digital I/O card output port).

**⑪ SYNC OUT field**

Selects the type of MIDI message to be used for synchronization.

- **OFF button** ..... Engage this button (it will appear inverted) to disable transmission of MIDI synchronization messages.
- **MTC button** ..... When this button is ON MTC will be transmitted while the recorder is running.
- **MIDI CLOCK Button** ..... When this button is ON the MIDI clock will be transmitted while the recorder is running. Also, appropriate START, STOP, CONTINUE and SONG POSITION messages will be transmitted when the transport is operated.

**HINT**

- MIDI clock operation is based on the tempo specified in the Tempo Map (refer to page 175 for Tempo Map setup details).

# Connecting to External Equipment

This section will provide some examples of how the AW2400 can be connected to and used with external MIDI devices.

## Synchronizing the AW2400 With External MIDI Devices

Using MTC AW2400 song playback and recording can be synchronized to external MIDI devices such as a computer-based sequencer application or a workstation type synthesizer with a built-in sequencer. Furthermore, MMC can be used to allow remote control of the AW2400 transport functions from the external MIDI device.

- 1 Refer to the following diagram, and connect the AW2400 to your workstation synthesizer or computer.

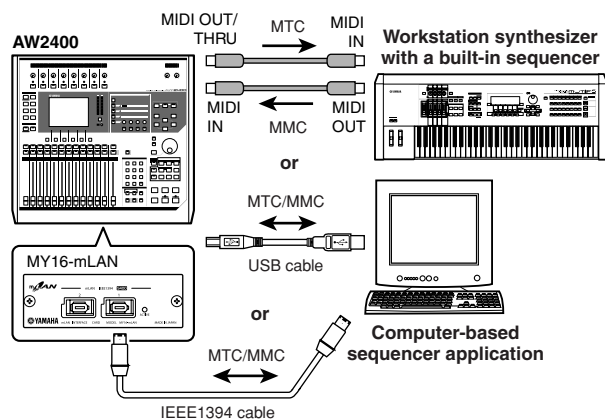

- 2 Use the Work Navigate section [MIDI] key to access the MIDI screen Setting 1 page. Select the connector(s)/port(s) to be used for MIDI message transmission and reception in the PORT field.

- 3 Use the Work Navigate section [MIDI] key to access the MIDI screen Setting 2 page. Turn on the MASTER button in the MTC field, and turn on the MTC button in the SYNC OUT field.

This sets the AW2400 to function as MTC master.

- 4 Turn on the SLAVE button in the MMC field. This sets the AW2400 to function as MMC slave.

- Example settings for synchronization using MTC and MMC

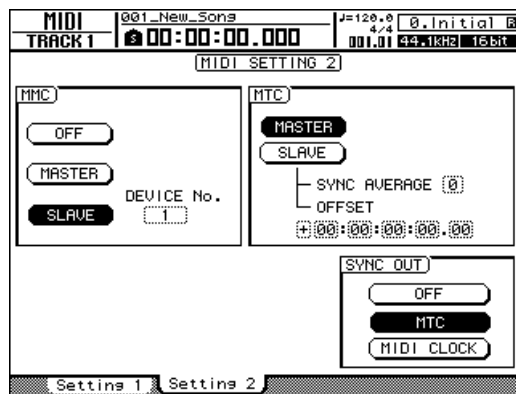

- 5 Move the cursor to the DEVICE No. field, and set the value to match the device number of the external MIDI device.

When using MMC, you must set the AW2400 and the external MIDI device to the same MMC device number. For details on the device numbers that your MIDI device can use, refer to its owner's manual.

- 6 Use the Work Navigate section [SONG] key to access the SONG screen Setting page. Select a frame rate.

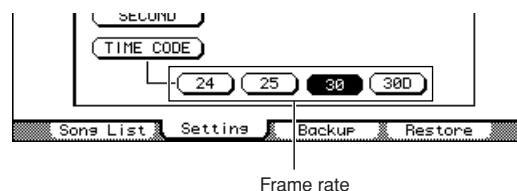

**HINT**

- When using MTC with an external device be sure to set both the AW2400 and the external device to the same frame rate.
- The frame rate you specify here will affect not only synchronization with the external device, but also the time code that is displayed in the counter, etc.

- 7 Set the external MIDI device to function as MMC master and MTC slave, and set its MMC device number and MTC frame rate to the same settings as the AW2400.

For details on how to make these settings, refer to the owner's manual provided with the device.



## 8 Play back the external MIDI device.

When you play back the external MIDI device, the corresponding MMC commands will be sent to the AW2400, and the AW2400 will begin running.

At the same time, the AW2400 will transmit MTC to the external MIDI device, and the external MIDI device will run in synchronization with it.



- You can synchronize using MIDI Clock and Start/Stop/Continue messages instead of using MTC and MMC. For details on the settings used in this case, refer to "Recording/playing AW2400 mix operations on an external sequencer" (→ p. 202).

## Switching AW2400 scenes from an external MIDI device

Here's how you can transmit program changes from an external MIDI device to switch scenes on the AW2400.

### Assign scenes to program changes

#### 1 In the Scene/Automix/USB section, use the [SCENE] key to access the SONG screen PGM Assign page.

This page lets you assign a scene number to each program change number.

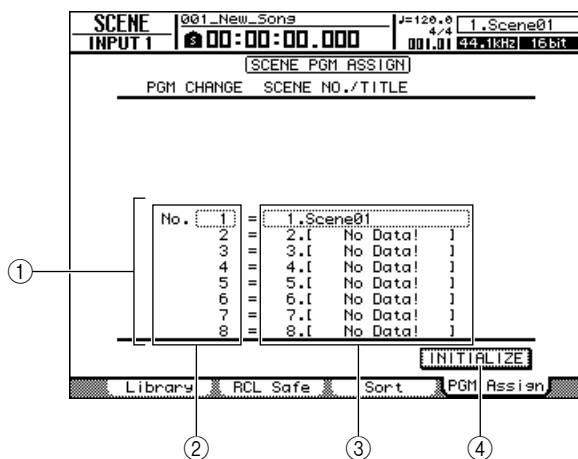

#### 1 List

This lists the scenes of the current song. The line enclosed by a dotted frame is the scene currently selected for operation.

#### 2 Program change number

This indicates the program change number (001–128). Move the cursor to this number and use the [DATA/JOG] dial to scroll the list upward or downward.

#### 3 Scene

Move the cursor to this area and use the [DATA/JOG] dial to select the scene that you want to assign to the corresponding program number.

#### 4 INITIALIZE button

Returns the program change assignments to their initial state.



- In the initial state Program change numbers 1–99 correspond to scenes 1–99, program change number 100 = Initial Data (all scene parameters in their initial state), and program change numbers 101–128 are "NO ASSIGN" (unassigned).

#### 2 Move the cursor to the program change number, and use the [DATA/JOG] dial to select the program change number for which you want to change the assignment.



- The [INC]/[DEC] keys can also be used to select program change numbers.

#### 3 Move the cursor to the scene in the list, and use the [DATA/JOG] dial to select the scene that you want to assign to the corresponding program change number.

#### 4 Repeat steps 2–3 to assign the desired scenes to other program change numbers.



- The PGM Assign page settings apply to all songs.
- If you want to reset the scene assignments to the initial setting, move the cursor to the INITIALIZE button and press the [ENTER] key.

## ■ Transmit program changes to switch scenes

1 Connect the AW2400 and your sequencer as shown in the diagram below.

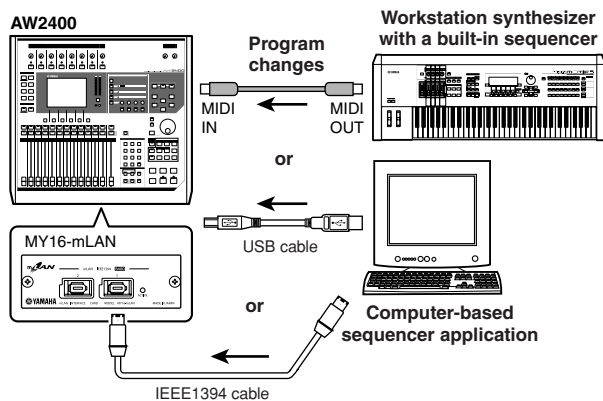

2 Use the Work Navigate section [MIDI] key to access the MIDI screen Setting 1 page.

3 Set the connector/port and channel to be used for program change message reception in the RX PORT and CHANNEL fields.

4 Turn the PROGRAM CHANGE (RX) field ON/OFF button on.

If you want to receive program change messages on all channels regardless of the MIDI receive channel setting, also turn the OMNI (RX) button on.

This sets up the AW2400 to receive MIDI program change messages.

5 Transmit a program change message from your sequencer to the AW2400 on the MIDI channel that you selected.

The scene assigned to that program change number will be recalled.

**HINT**

• If you insert program changes into the appropriate locations of your sequencer track, scenes will be recalled automatically as the AW2400 and your sequencer run in synchronization.

## Recording/playing AW2400 mix operations on an external sequencer

Here's how you can synchronize the AW2400 and your external sequencer, and use the sequencer to record/play the fader and pan operations you perform on the AW2400. Since operating the AW2400's mix parameters will cause a large number of control change messages to be transmitted, we will use MIDI Clock (which uses less data) as the synchronization signal rather than MTC.

1 Connect the AW2400 and your sequencer as shown in the following diagram.

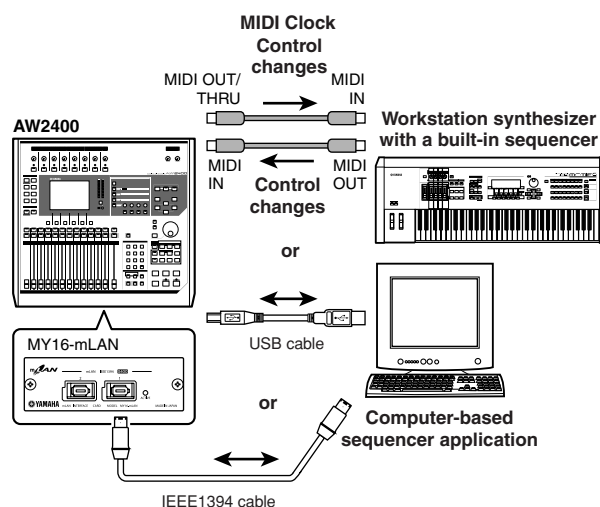

2 Use the Work Navigate section [MIDI] key to access the MIDI screen Setting 2 page. Turn on the MASTER button in the MTC field, and turn on the MIDI CLOCK button in the SYNC OUT field.

- Example settings for synchronization using MIDI Clock and Start/Stop/Continue

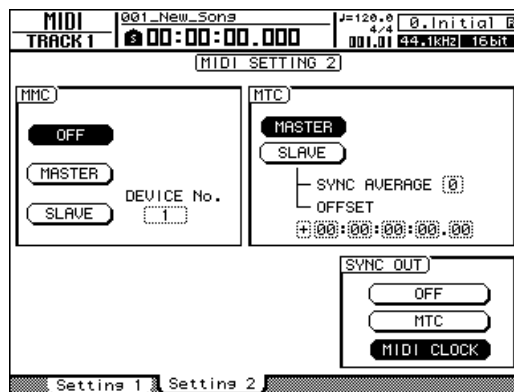

**3 Use the Work Navigate section [MIDI] key to access the MIDI screen Setting 1 page. Select the connector(s)/port(s) to be used for MIDI message transmission and reception.**

**4 Turn the CONTROL CHANGE field ON/OFF buttons (TX and RX) on.**

This sets the AW2400 to transmit and receive control change messages.

**5 Select a CONTROL CHANGE MODE (1–3).**

The CONTROL CHANGE MODE lets you choose one of three combinations (1–3) that specify how control changes will correspond to the mix parameters of the AW2400. (For details on the contents of each choice, refer to page 195.)

If you want to transmit and receive messages via separate MIDI channels for each of the AW2400's track channels, choose 1. If you want all track channels to be controlled via a single MIDI channel, choose 2 or 3.

If you chose 2 or 3, you will also need to set the CHANNEL field to specify the MIDI channel that will be used to transmit and receive the control changes.

**6 Make the appropriate settings on your sequencer so that it will follow external MIDI Clock messages. Also set the sequencer to record-ready mode.**

For details on how to make these settings, refer to the manual for your sequencer.

**NOTE**

- If your sequencer has a function by which MIDI messages received at its MIDI IN connector are retransmitted from its MIDI OUT connector (a function called "MIDI Echo" or "MIDI Thru"), be sure to turn it off. If this function is turned on while you are recording, the control change messages transmitted when you operate the AW2400 will be immediately returned to the AW2400, causing improper operation.

**7 Store the initial fader, pan, and mix parameters as a scene at the beginning of the song.**

When the following operations are performed this scene will always be recalled at the beginning. Also, if you record a program change number corresponding to this scene at the beginning of a sequencer track the scene will automatically be recalled each time the sequence is played back. (refer to "Switching AW2400 scenes from an external MIDI device" on page 201 for details).

**8 Play back the AW2400 song from the beginning.**

When the AW2400 begins playback, it will transmit a Start message and MIDI Clock messages to the sequencer, and the sequencer will begin running in synchronization with the AW2400.

**9 Operate the AW2400's mix parameters (fader, pan, etc.) as required.**

The control changes assigned to each parameter will be recorded on the sequencer.

The type of mix parameters that can be recorded will depend on the setting of the CONTROL CHANGE MODE field (→ p. 195).

**10 When you are finished recording, stop playback of the AW2400 song.**

**11 Set the sequencer to the playback standby mode, recall the previously stored scene, and start AW2400 playback from the beginning of the song.**

The recorded control changes will be transmitted to the AW2400, and the corresponding mix parameters will change accordingly. If necessary, you can use the editing functionality of your sequencer to edit the values and timing of the control changes that were recorded.

**NOTE**

- If you set CONTROL CHANGE MODE to 1, operating track channels 1–16 will transmit control changes via the corresponding MIDI channel (1–16). For this reason, you should normally record operations only for a single channel at a time, unless your sequencer is able to record multiple MIDI channels simultaneously.

## Using the MIDI Remote function

### About the MIDI Remote function

The AW2400 provides a MIDI Remote function that lets you use the top-panel controls to transmit the desired MIDI messages.

By using the MIDI Remote function, you can use the AW2400 as a physical controller for a computer program or MIDI tone generator.

MIDI messages can be assigned to the following controls.

#### ● Mixer section

- Faders 1–12, 13–16
- [ON] keys 1–12, 13–16

#### ● Transport section

- RTZ [◀] key
- REW [◀◀] key
- FF [▶▶] key
- STOP [■] key
- PLAY [▶] key
- REC [●] key

Of these, MIDI messages assigned to the faders and [ON] keys can be freely reassigned. You can assign the following types of message.

### ■ Messages that can be assigned to faders

A MIDI message whose value changes over a range of 0–127 can be assigned to each fader. For example if you assign control change #7 (volume) to a fader, you can use the fader to control the volume of a MIDI tone generator.

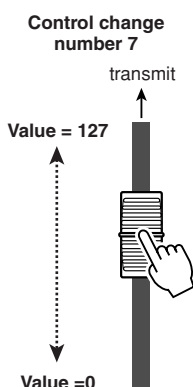

### ■ Messages that can be assigned to the [ON] keys

A MIDI message whose value changes between the two states, 0 and 127, can be assigned to each [ON] key. For example if you assign control change #64 (hold) to an [ON] key and specify that the control change value alternates between 0 and 127, pressing the [ON] key to turn it on (indicator lit) will transmit control change #64 with a value of 127 (Hold on), and turning it off (indicator out) will transmit control change #64 with a value of 0 (Hold off).

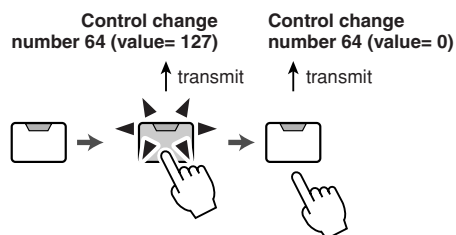

Alternatively, you can specify that a MIDI message with a fixed value is transmitted only when you press the [ON] key to turn it on (indicator lit). For example if you assign program change #1, that program change number will be transmitted each time you turn on the [ON] key.

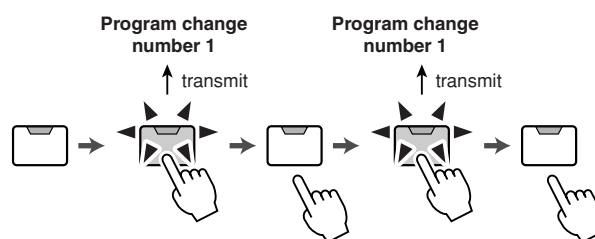

### Using the MIDI Remote function presets

The REMOTE screen 1–12 page and 13–16 page provide 14 different MIDI Remote presets (ten factory presets and four user presets). These presets have been created with specific devices and computer sequencer programs in mind, and assign the necessary messages to the AW2400's faders and [ON] keys. You can use the MIDI Remote function immediately, just by selecting a preset in this page and connecting the appropriate external MIDI device.

### Sequencer programs that are supported

#### ● Windows

- Cubase SX 3.0.1
- Logic Platinum 5.5.1 (\*1)
- Nuendo 3.0.1
- Sonar 4.0.1 Producer Edition

#### ● Macintosh

- Cubase SX 3.0.1
- Logic Pro 7.0.1 (\*1)
- Nuendo 3.0.1
- Protools TDM 6.7 (\*2)

\*1 Use the setting file from the included CD-ROM to map the AW2400's faders/[ON] keys/transport keys to the Logic key commands. Track assignments must be made within Logic as appropriate for your system.

\*2 Select the CS-10 settings as the MIDI controller type. For details on the CS-10 settings, ask Digidesign.

The MIDI channels corresponding to the faders and [ON] keys appears as follows when the REMOTE screen 1–12 and 13–16 pages are selected.

#### ■ When the 1–12 page is showing.

Fader/[ON] Key	1	2	3	4	5	6	7	8	9	10	11	12
MIDI Channel	1	2	3	4	5	6	7	8	9	10	11	12

#### ■ When the 13–16 page is showing.

Fader/[ON] Key	1	2	3	4	5	6	7	8	9	10	11	12
MIDI Channel	13	14	15	16	N/A							

To call the REMOTE screen 1–12 page press the Layer section [REMOTE] key as many times as necessary, or press the [F1] key after pressing the [REMOTE] key.

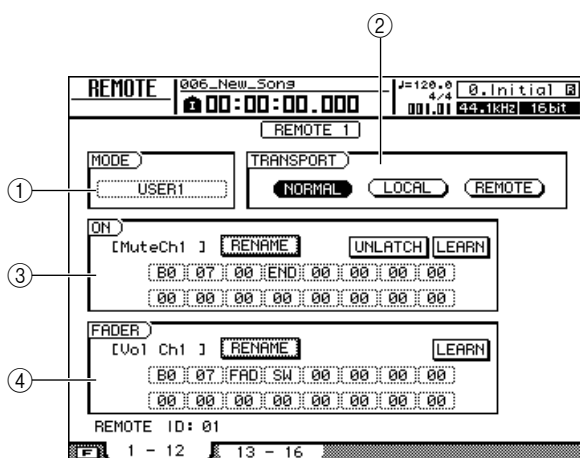

To call the REMOTE screen 13–16 page press the Layer section [REMOTE] key as many times as necessary, or press the [F2] key after pressing the [REMOTE] key (Operation of the 13–16 page is the same as the 1–12 page).



- The MIDI Remote function will automatically be on while the REMOTE screen is displayed. The channel faders and [ON] keys will not perform their usual functions, but will work as specified by the preset you have selected in the REMOTE screen.

This page contains the following items.

#### ① MODE box

Selects one of the ten presets. Move the cursor to a box and use the [DATA/JOG] dial or [INC]/[DEC] keys to select the corresponding preset for instantaneous MIDI message assignment.

The AW2400 provides the following presets.

- Cubase
- Logic
- Sonar
- Protools

These presets let you use the AW2400 as a physical controller for various software sequencers.

- [ON] key operations will control mute on/off operations on the sequencer software.
- Fader operations will control the volume of the sequencer software tracks.

You will need to install the appropriate setting file into your sequencer software, and make the necessary settings. For details, refer to the “About the CD-ROM included with the AW2400” (→ p. 266).

#### ● Volume/Rec TR

Use this preset to control the volume of an external tone generator or the record tracks of an external recorder.

- [ON] key operations will transmit MMC commands to select recording tracks.
- Fader operations will transmit Volume control changes (CC#=07).

#### ● Volume

Use this preset to control the volume of an external tone generator.

- When you turn an [ON] key off (indicator out), volume = 0 will be transmitted.
- When you turn an [ON] key on (lit green), the volume value corresponding to the fader position will be transmitted.
- When an [ON] key is on, operating the fader will transmit Volume control change messages (CC#=07).

- XG 1–16
- XG 17–32
- XG 33–48
- XG 49–64

These presets let you use the AW2400 as a volume controller for an XG tone generator. Each preset will control the XG-compatible tone generator’s parts 1–16, 17–32, 33–48, and 49–64 respectively.

- [ON] key operations will switch the part on/off.
- Fader operations will control the volume of the part.

- USER1
- USER2
- USER3
- USER4

These 4 presets can be set up by the user. Refer to “Using User-defined Remote function”.

② **TRANSPORT field**

Select one of the following to specify how the transport section keys will function while using the MIDI Remote function.

- **NORMAL button** ..... The transport keys will perform their normal functions: play, stop, or locate etc. for the current song. MTC/MMC/MIDI Clock messages will be transmitted and received as specified in the MIDI screen Setting 2 page.
- **LOCAL button**..... The transport keys will play, stop, or locate the current song. However, MTC/MMC/MIDI Clock messages will not be transmitted or received.
- **REMOTE button**..... The transport keys will not operate the recorder, but will only transmit the MIDI messages that have been preset for each key.



- These settings will also apply if you use a foot switch to operate the song transport.

- ③ **ON field**
- ④ **FADER field**

This field is used when setting up a user-defined preset.

## Using User-defined Remote function

The REMOTE screen 1–12 page and 13–16 page let you assign your own MIDI messages to each fader and [ON] key.

To call the REMOTE screen 1–12 page (or 13–16 page) press the Layer section [REMOTE] key as many times as necessary, or press the [F1] key (or [F2] key) after pressing the [REMOTE] key.



- USER1–USER4 must be selected in the MODE box in order to set up user-defined assignments.

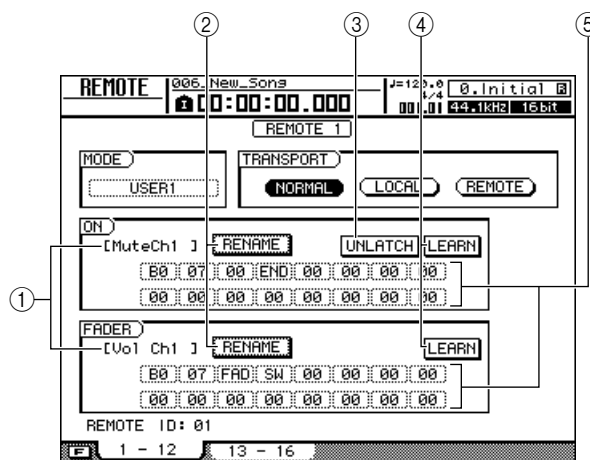

① **Fader/[ON] key function name**

Displays the name that is assigned to the currently displayed fader or [ON] key.

② **RENAME button**

Edits the name that is assigned to the fader/[ON] key. Move the cursor to the button and press the [ENTER] key, and the NAME EDIT popup window will appear.

③ **LATCH/UNLATCH button**

Selects one of the following types of operation for the [ON] keys.

- **LATCH**..... The setting will alternate on/off each time you press the [ON] key.

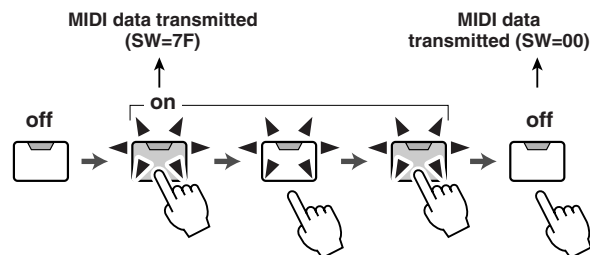

- **UNLATCH** ..... The [ON] key will be engaged only while held, and will turn off when released.

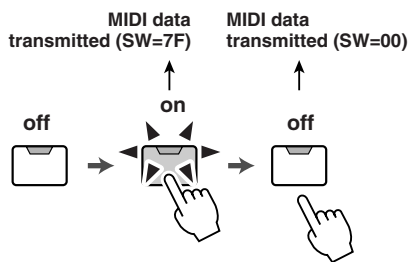

#### ④ LEARN button

When this button is on, the MIDI message received from an external device will be assigned to the currently selected fader or [ON] key. This is a convenient way to assign MIDI messages quickly.

##### HINT

- If two or more MIDI messages are received while the LEARN button is on, the last-received MIDI message will be entered in the MIDI message field.
- If a system exclusive message longer than sixteen bytes is received, the first sixteen bytes will be displayed.

##### NOTE

- The [ON] key and fader LEARN buttons cannot be engaged simultaneously.

#### ⑤ MIDI message

This area displays the MIDI message that is assigned to the currently selected fader or [ON] key in hexadecimal form.

You can move the cursor to each number box and use the [DATA/JOG] dial to edit the value of each byte (two-digit hexadecimal number). You can select the following values.

- **00–FF (hexadecimal)** ..... Corresponds to the actual value of the MIDI message that is transmitted.
- **END** ..... Indicates the end of the MIDI message. When you operate a fader or [ON] key, the MIDI message starting with the first byte and ending with the byte that precedes END will be transmitted.
- **SW ([ON] key only)** ..... Indicates the on/off status of the [ON] key. The byte you specify as SW will be transmitted as 7F (hexadecimal) when the key is turned on, or 00 (hexadecimal) when the key is turned off.
- **FAD** ..... Indicates the current position of the fader. If the message is assigned to a fader, the byte you specify as FAD will be transmitted as a value of 00–7F (hexadecimal) corresponding to the fader position when you operate the fader. If the message is assigned to an [ON] key, this byte will be transmitted as a value corresponding to the current position of the fader when the [ON] key is turned on, and will be transmitted as a value of 00 (hexadecimal) when the [ON] key is turned off.

##### HINT

- The MIDI message assigned to a single fader or key cannot be longer than sixteen bytes.
- If a SW byte is not assigned to an [ON] key, the MIDI message you enter will be transmitted only when you turn the key on. (In this case you will normally use the UNLATCH setting.)
- When you use the LEARN button to assign a control change message to a fader, the END byte will automatically be entered at the end of the MIDI message.
- When you use the LEARN button to assign a control change message to a fader, the FAD byte will be automatically entered as the variable value.

##### NOTE

- If you assign a MIDI message manually, be sure to enter END at the end of the message.
- When you assign a MIDI message to a fader, FAD must be entered for one of the bytes. If FAD is not entered the fader will not function.
- If you enter the values manually, it is possible that an invalid MIDI message will be entered. For this reason, you should use the LEARN button to assign MIDI messages whenever possible.

## Remotely controlling a tone generator module

Here's how you can use the AW2400's MIDI Remote function to remotely control a tone generator module.

### 1 Connect the AW2400 to your tone generator module as shown in the following diagram.

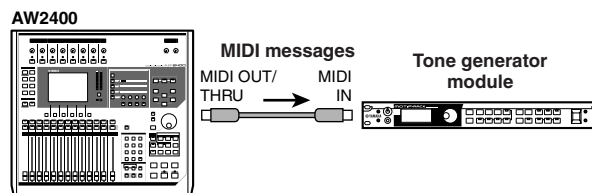

### 2 Use the Layer section [REMOTE] key to call the REMOTE screen 1–12 page or 13–16 page.

This enables the Remote function.

##### HINT

- While the REMOTE screen is displayed, the functions of the faders and [ON] keys will be disabled; the faders and keys will function as controllers that transmit MIDI messages.
- When the MIDI Remote function is enabled, the MIDI messages are transmitted via the connector/port selected in the MIDI screen Setting 1 page REMOTE OUT box.

**3 Select the preset you want to use in the MODE box and press the [ENTER] key.**

For example if you select preset “XG 1-16”, the AW2400’s faders will control the volume of parts 1–16 of your XG tone generator, and [ON] keys 1–16 will control the on/off status of parts 1–16.

**4 If necessary, select the REMOTE screen 1–12 or 13–16 pages and set the MIDI channel assignments to the faders and [ON] keys as required.**

The MIDI channel assignments on each page are described in “Using the MIDI Remote function presets” on page 204.

**5 Operate the AW2400 faders and [ON] keys.**

The messages assigned to the faders and [ON] keys will be transmitted via the MIDI OUT/THRU connector, and the parameters of your tone generator module will change accordingly.



# ◆ Chapter 21 ◆

## Utility functions

This chapter explains the AW2400's various utility functions.

### Using the test tone oscillator

The Oscillator page of the UTILITY screen lets you send the signal of the AW2400's built-in test oscillator to the desired bus.

To call this page press the Work Navigate section [UTILITY] as many times as necessary, or press the [F1] key after pressing the [UTILITY] key.

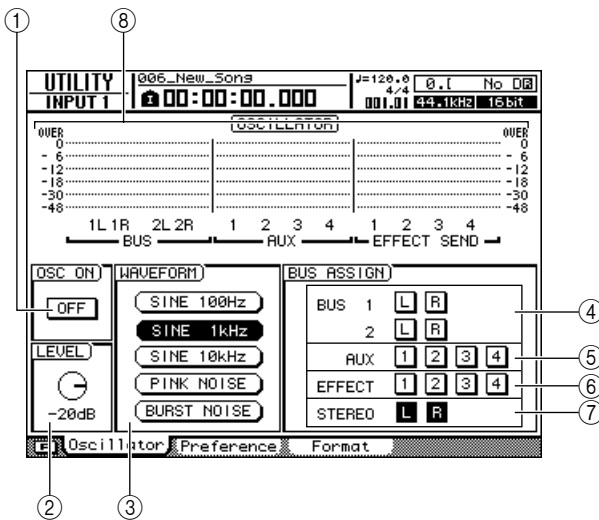

This page contains the following items.

#### ① OSC ON button

When you turn this button on, the oscillator output will immediately be sent to the specified bus. Use the ④–⑦ buttons to specify the bus to which the signal will be sent.



- Pressing the [F1] key while holding the Display section [SHIFT] key has the same affect as the OSC ON button.

#### ② LEVEL knob

Adjusts the output level of the oscillator.



- Be sure to lower the setting of the LEVEL knob before turning on the oscillator to prevent sudden high-volume output.

#### ③ WAVEFORM

Selects one of the following oscillator signals.

- **100Hz button** ..... 100 Hz sine wave
- **1kHz button** ..... 1 kHz sine wave
- **10kHz button** ..... 10 kHz sine wave
- **PINK NOISE button** ..... Pink noise
- **BURST NOISE button** ..... Burst noise (20-millisecond pink-noise bursts as 4-second intervals)

#### ④ BUS1 L/R, BUS2 L/R buttons

Sends the oscillator output to the Bus 1 L/R or Bus 2 L/R.

#### ⑤ AUX1–4 buttons

Send the oscillator output to AUX buses 1–4.

#### ⑥ EFFECT1–4 buttons

Send the oscillator output to effect buses 1–4.

#### ⑦ STEREO L/R buttons

Sends the oscillator output to the stereo bus.

#### ⑧ Level Meter

Displays the BUS 1–2, AUX 1–4, and EFFECT BUS 1–4 output levels.



- Sine waves and white noise have a higher actual sound pressure level than perceived by the ear, and may damage your speakers if played at a high volume. Please use caution.

# AW2400 Preferences

The UTILITY screen Preference page provides a number of basic “preference” parameters for the AW2400 operating environment, including digital input/output setup, copy protection, and others.

To call this page press the Work Navigate section [UTILITY] key as many times as necessary, or press the [F2] key after pressing the [UTILITY] key.

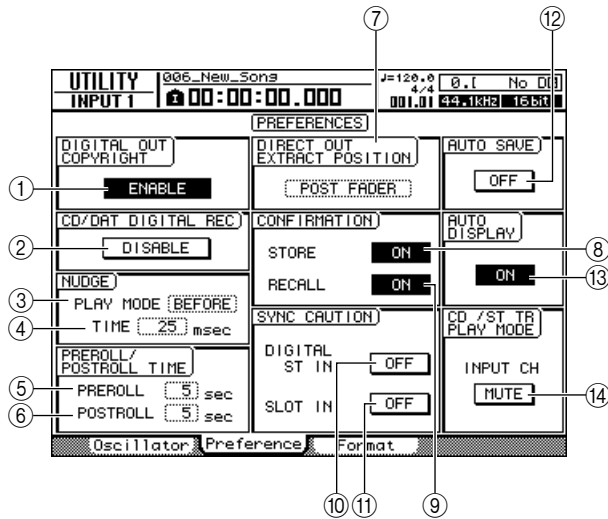

This page contains the following items.

**① DIGITAL OUT COPYRIGHT button**

Specifies whether SCMS (Serial Copy Management System) copy protect flags will be written into the digital signal that is output from the DIGITAL STEREO OUT jack. Protect is enabled if the button is set to ENABLE, and disabled if the button is set to DISABLE.

If copy protect is enabled, you will be able to copy the signal from the DIGITAL STEREO OUT jack to an MD or DAT recorder, but it will not be possible to make a second-generation digital copy from that data.

● **When copy protect is enabled**

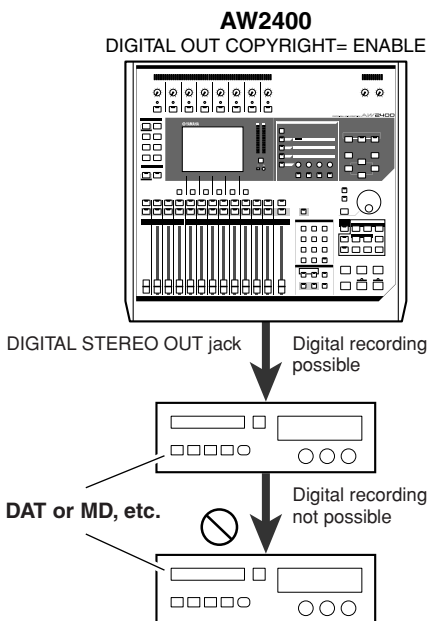

**② CD/DAT DIGITAL REC button**

Enables or disables digital recording from the DIGITAL STEREO IN jack, and importing of digital audio data from an audio CD or WAV file inserted in the CD-RW drive.

When this parameter is ON, the following message will be displayed.



If you agree to the conditions stipulated in the “Copyright Notice” (→ p. 7), select [OK]. Recording and importing of digital audio data will be enabled when you select [OK].

**HINT**

- The CD/DAT DIGITAL REC button will always be set to the default DISABLE setting when you turn on the power.

**③ NUDGE PLAY MODE**

Selects the playback method that will be used by the Nudge function (a function that lets you use the [JOG ON] key and [DATA/JOG] dial to search for a location). Press the [ENTER] key to confirm your selection.

- **AFTER** ..... Play repeatedly for the duration specified by the NUDGE TIME, starting at the current location.
- **BEFORE** ..... Play repeatedly for the duration specified by the NUDGE TIME, ending at the current location.

**MODE: BEFORE**

Current location

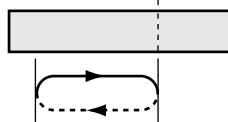

**MODE: AFTER**

Current location

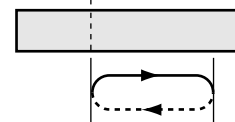

**④ NUDGE TIME**

Specifies the duration (Nudge Time) of each repeat played by the Nudge function. The nudge time can be set from 25 to 800 ms in 1 ms (millisecond) steps.

**⑤ PREROLL TIME**

Specifies the duration of the preroll (the amount of playback time before the punch-in point) when you use Auto Punch-in from 0 to 20 seconds.

**⑥ POSTROLL TIME**

Specifies the duration of postroll (the amount of playback time after the punch-out point) when you use Auto Punch-out from 0 to 20 seconds.

**⑦ DIRECT OUT EXTRACT POSITION**

Selects the point in the input channel or track channel from which the signal will be taken when using DIRECT OUT. Press the [ENTER] key to confirm your selection.

- **PRE FADER**.....the signal prior to the channel fader
- **POST FADER** .....the signal after the channel fader

**⑧ STORE CONFIRMATION button**

Specifies whether the NAME EDIT popup window (allowing you to assign a name) will appear when you store a scene/library.

**⑨ RECALL CONFIRMATION button**

Specifies whether a popup window will ask you for confirmation when recalling a scene or library.

**⑩ SYNC CAUTION DIGITAL ST IN button**

Determines whether an error message will be displayed when a signal that is not synchronized with the word clock source appears at the DIGITAL STEREO IN connector.

**⑪ SYNC CAUTION SLOT IN button**

Determines whether an error message will be displayed when a signal that is not synchronized with the word clock source appears at a digital input on an I/O card installed in the I/O slot.

**⑫ AUTO SAVE button**

Enables or disables the Auto Save function. When the Auto Save function is enabled the current song state will be backed up to temporary memory when one of the following occurs. If the power is accidentally turned off before the unit is properly shut down, the song will be restored from the backup data in temporary memory the next time the power is turned on.

- Recording is stopped.
- Track editing is ended.
- Import from the CD-RW drive is completed.
- Import of a WAV file is completed.

**⑬ AUTO DISPLAY button**

Determines whether the display screen related to a key or knob operated in the Selected Channel section will appear automatically (ON), or whether the display will remain as it is and a popup window for the corresponding parameter will appear (OFF).

**⑭ CD/ST TR PLAY MODE MUTE/MIX button**

Determines whether the input channels will be output together with CD or stereo playback (MIX), or whether only the CD or stereo track signal will be output (MUTE).

# Initializing the internal hard disk

The UTILITY screen Format page lets you initialize the internal hard disk. Prior to exporting and importing WAV files to or from a Macintosh computer (Mac OS X 10.3) it may be necessary to initialize the hard disk in order to change the hard disk cluster size.

**NOTE**

- Executing the Format operation will erase all data from the internal hard disk, and the data cannot be recovered. We recommend that you backup all data on the internal hard disk to a computer before executing the Format operation.
- You cannot abort the Format operation once it has been started.
- Never turn off or disconnect the power during formatting, since this may damage the hard disk and cause malfunctions.

To call this page press the Work Navigate section [UTILITY] key as many times as necessary, or press the [F3] key after pressing the [UTILITY] key.

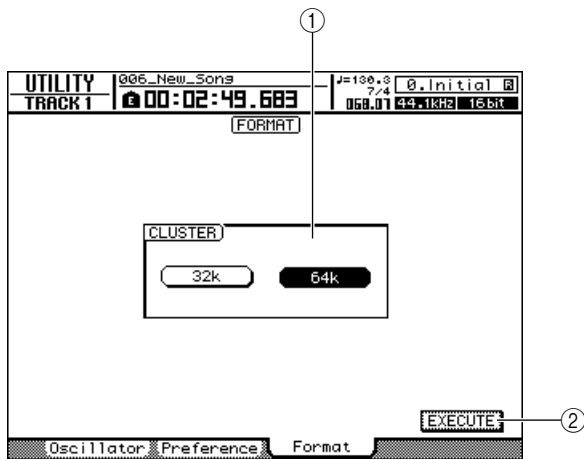

① **CLUSTER field**

Set the disk cluster size to either 32K or 64K. If you will be using Mac OS X 10.3 for WAV file transfer operations, set the cluster size to 32K. Select the 64K cluster size for maximum speed if you will be using Windows, or Mac OS X 10.4 or higher. When the AW2400 is shipped from the factory, the cluster size is set to 64K.

② **EXECUTE button**

Execute the disk initialization. A popup window will show the progress of the initialization operation. The popup window will close when initialization has been completed.

## ◆ Chapter 22 ◆

# Creating an audio CD

This chapter explains how you can use the CD-RW drive to create an audio CD, and how to play back an audio CD.

## Creating an audio CD

You can select one or more songs on the AW2400 hard disk, and write the audio data from the stereo track of each song to a CD-R/RW disc in CD-DA format. The CD-R/RW media to which you write this data can be played by a CD-RW drive or a conventional CD player in the same way as a standard audio CD.

### NOTE

- Some CD players do not support CD-R/RW media, and may not be able to play back CDs created by the AW2400.

In order to create a CD, you must first register one or more songs in a “track list,” and then write the virtual track currently selected for the stereo track of each song (the “current track”) to the CD in the order specified by the track list.

A maximum of 99 tracks (areas on CD media to which audio data can be written individually) can be written to one CD-R/RW disc, and each track must be at least four seconds long. The maximum length of audio that can be written to a single disc is approximately 74 minutes for 650 MB discs, or approximately 80 minutes for 700 MB discs.

### HINT

- The total size of audio data that can be written to a single disc is 746 MB (approximately 74 minutes) for 650 MB discs, or 807 MB (approximately 80 minutes) for 700 MB discs.

## Types of media that you can use with the CD-RW drive

The AW2400 CD-RW drive can use two types of media: “CD-R” which lets you record and append data, and “CD-RW” which can be erased and rewritten as required. These types of media have the following characteristics.

### ● CD-R

You can write data to a new CD-R disc, and append additional data later on. You cannot erase data that has already been written and rewrite the disc. Once you perform a process known as “finalizing the disc,” the audio data written to the CD-R can be played by a CD-RW drive or by most CD players.

### ● CD-RW

In addition to writing and appending data, this type of media lets you erase all recorded data and write new data to the disc. Audio data written to a CD-RW can be played back by a CD-RW drive or by CD players that support CD-RW media.

# Writing an audio CD

There are two ways in which you can write audio data to CD-R/RW media.

## ● Track At Once

This method writes the data one CD track at a time. The advantage of this method is that you can add new data to a disc that already contains data.

With the Track At Once method, the data from the beginning to the end of a song's stereo track is written to the CD as one track. (Even if there is a portion during the song that contains no data, it will be written as silent audio.) Since each track is written individually, an interval of approximately two seconds will be created between each track.

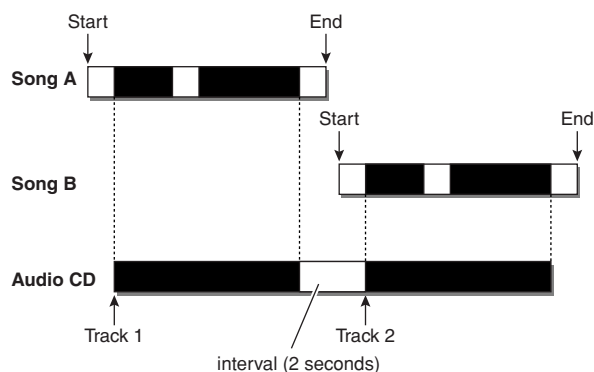

In order for a disc written using Track At Once to be playable by the AW2400 CD-RW drive or a CD player, you must perform a process known as "finalizing" to write track information to the disc. Once you have finalized a disc, no more data can be written to it.

## ● Disc At Once

This method writes all tracks at once. As when using the Track At Once method, the data from the beginning to the end of the stereo track of each song is written to the CD as one track.

However since writing does not stop until all data has been written, there does not necessarily have to be gaps between the tracks.

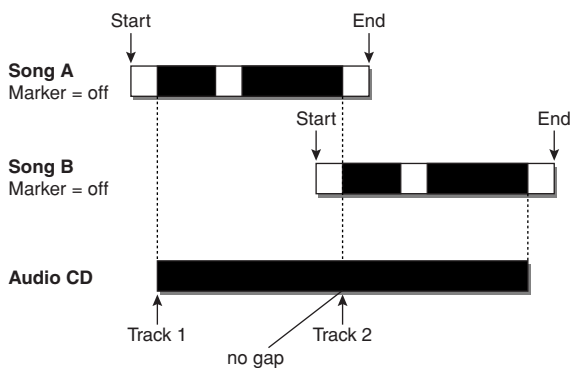

When using Disc At Once to write a CD, you can use the start point, end point and markers that were assigned within the AW2400 song to divide a single continuous song into multiple tracks.

This is convenient, for example, when you have recorded a live performance as a single song and want to assign track numbers while leaving playback in continuous form.

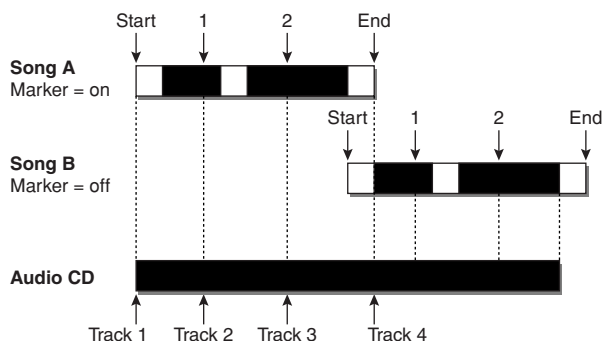

### NOTE

- Tracks shorter than four seconds cannot be written to an audio CD. If you use start point/end point/markers to divide a song into multiple tracks, make sure that each track is at least four seconds long.
- If the length of the stereo track exceeds the writable length of the media, you can create an audio CD by adjusting the start point/end point so that the region is within the allowable length. (→ p. 88)

Media written using Disc At Once will be finalized automatically, and can be played back by a CD-RW drive or CD player that supports that type of media. However, no further data can be written to a disc that was written using Disc At Once.

## Basic settings for the CD-RW drive

Before you actually write data to a CD, you will need to make basic settings for the CD-RW drive.

- 1 Call the Setting page by either pressing the Work Navigate section [CD] key as many times as necessary, or by pressing the [F3] key after pressing the [CD] key.

The CD screen Setting page will appear.

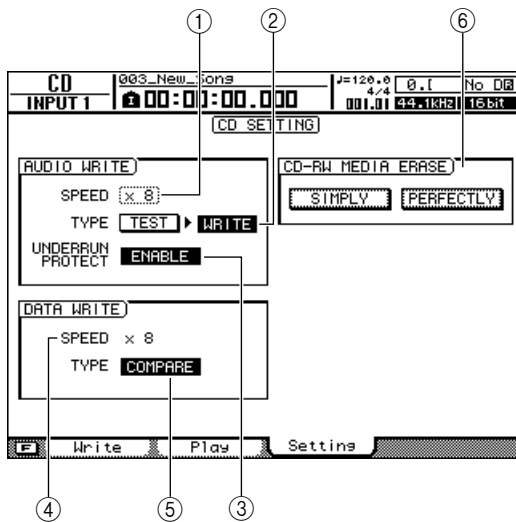

### ① AUDIO WRITE SPEED

Selects the speed at which audio data will be written to CD-R/RW media.

### ② AUDIO WRITE TYPE

Selects the write method to be used when writing audio data to CD-R/RW media.

### ③ UNDERRUN PROTECT button

Enables/disables the function that prevents buffer underrun (an error that can occur when data transfer cannot keep up with write speed).

### ④ DATA WRITE SPEED

This indicates the speed at which data other than CD audio (e.g., backup data or WAV files) is written to CD-R/RW media. Normally this will indicate x8, but may be x4 if the media supports a maximum write speed of x4. This field is for display only, and cannot be edited.

### ⑤ DATA WRITE TYPE

Selects the write method to be used when writing backup data to CD-R/RW media.

If the COMPARE button is on, the original data will be compared with the backed-up data or the exported WAV file after a backup or export operation, to check whether any errors occurred while writing the data.

Refer to “Backing up songs” on page 177 for information on backup procedures.

### ⑥ CD-RW MEDIA ERASE

Erases the data that was written to CD-RW media. For details, refer to “Erasing CD-RW media” (→ p. 221).

- 2 Move the cursor to the AUDIO WRITE SPEED field, and turn the [DATA/JOG] dial to select the write speed.

You can select either x8 (eight times audio playback speed) or x4 (four times audio playback speed). Normally you should use x8, and reduce the speed to x4 only if errors occur during writing.

#### HINT

- In addition to the [DATA/JOG] dial, the [INC]/[DEC] keys can be used to make selections.

- 3 Use the TEST and WRITE buttons of the AUDIO WRITE TYPE field to select the write operation(s).

The combination of buttons will determine the operation(s) that will occur, as follows.

- **Only the TEST button On**  
..... Only a write test will be performed.
- **Only the WRITE button On**  
..... Writing will occur immediately.
- **Both the WRITE and TEST buttons On**  
..... First a write test will be performed, and then the actual writing will be performed.

Depending on the media and the state of the hard disk, it is possible that an error may occur while the data is being written. (If you are using a CD-R, this will make the media unusable.) You can turn on the TEST button to check whether an error will occur before you actually write the disc. If an error occurs during the test, halt the procedure, and either reduce the write speed or set the UNDERRUN PROTECT button to ENABLE.

- 4 If desired, set the UNDERRUN PROTECT button to ENABLE.

The AW2400 CD-RW drive has a function to prevent “buffer underrun” errors that can occur if data transfer cannot keep up with the write speed.

Switch the UNDERRUN PROTECT button to the “ENABLE” setting to prevent buffer underruns.

#### HINT

- The CD-RW drive factory settings can be restored from the CD screen CD Setting page by pressing the [F3] key (DEFAULT) while holding the [SHIFT] key.

#### NOTE

- If the UNDERRUN PROTECT button is set to ENABLE, the TEST button will automatically be turned off. Also, if the TEST button is turned on, the UNDERRUN PROTECT button will automatically be set to DISABLE.

# Writing audio data

Here's how to write the audio data from the stereo track of each song to a CD-R/RW disc in CD-DA format.

Audio data write operations are accessed via the CD screen Write page.

To call this page press the Work Navigate section [CD] key as many times as necessary, or press the [F1] key after pressing the [CD] key.

This page contains the following items.

## ■ If you turn on the TRACK AT ONCE button

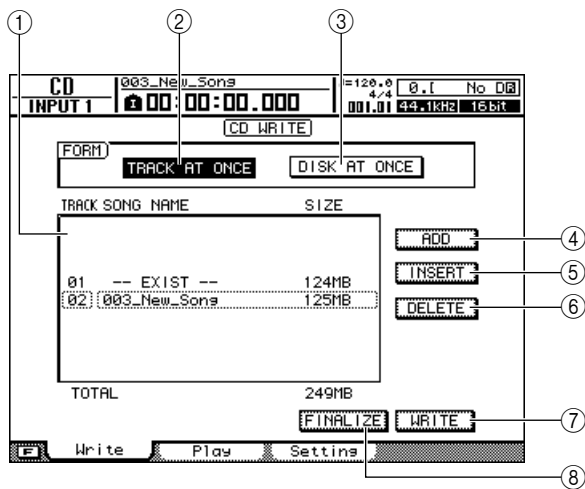

### ① Track list

This is a list of the songs containing stereo tracks that will be written to the CD-R/RW media. The line enclosed by a dotted frame is currently selected for operations. If no songs have been registered, this will indicate “-NO TRACK-”.

If audio data has already been written to the inserted CD-R/RW media but the media has not yet been finalized, “--EXIST--” will be displayed for the already-written data.

### ② TRACK AT ONCE button

Turn this button on to create an audio CD using the Track At Once method.

### ③ DISK AT ONCE button

Turn this button on to create an audio CD using the Disc At Once method.

### ④ ADD button

Adds a song at the end of the track list.

### ⑤ INSERT button

Inserts a new song in front of the song currently selected in the list.

### ⑥ DELETE button

Deletes the selected song from the list.

### ⑦ WRITE button

Executes the actual CD write operation.

### ⑧ FINALIZE button

**(only displayed for TRACK AT ONCE)**

Finalizes the disc so that it can be played on a CD-RW drive or standard audio CD player.

## ■ If you turn on the DISC AT ONCE button

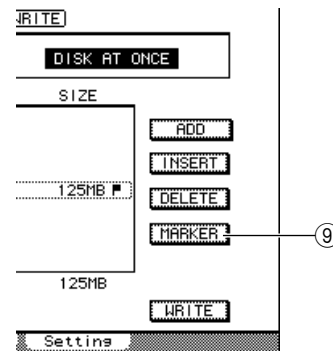

### ⑨ MARKER button

**(only displayed for DISC AT ONCE)**

For each stereo track, this enables or disables the markers that have been set within that song.

When you move the cursor to this button and press the [ENTER] key, the start point, end point and markers within the currently selected stereo track will be enabled. (A “flag” icon will appear at the right of the list.) If markers are enabled for a stereo track, a track number will be written to the CD at the location of each marker. Regardless of any areas of silence, the entire region from the Start point to the End point will be written.



## Writing Track At Once

Here's how to use the Track At Once method to write stereo tracks from songs saved on the hard disk to CD-R/RW media. Use this method if you expect to be adding tracks to the disc later, or if you want an automatic two-second gap between tracks.

### 1 Make sure that the appropriate virtual track is selected for the stereo track of the song(s) you want to write.

Only the virtual track that can be played by the stereo track (i.e., the "current track") will be written to disc. If the correct virtual track is not selected, load the desired song, use the TRACK screen Stereo TR page to switch to the correct virtual track, and then save the song.

### 2 Call the CD screen Write page by either pressing the Work Navigate section [CD] key as many times as necessary, or by pressing the [F1] key after pressing the [CD] key.

### 3 Insert a CD-R/RW disc in the drive, move the cursor to the TRACK AT ONCE button, and press the [ENTER] key.

The inserted CD-RW will be automatically checked.

#### HINT

- If data has already been written on the inserted CD-RW disc, a popup window will appear immediately after step 3 asking whether you want to erase the data. If you want to erase the entire disc move the cursor to the OK button. If you want to cancel the audio CD write operation, move the cursor to the CANCEL button. Then press the [ENTER] key.

### 4 Move the cursor to the ADD button and press the [ENTER] key.

The track list will show information (track number/song name/size of the stereo track) for the song that will be written to track 1 of the CD.

#### HINT

- When you move the cursor to the ADD button and press the [ENTER] key, a new song will be added following the existing songs.
- By using the INSERT button instead of the ADD button, you can insert a new song immediately before the song that is selected in the list.
- You can use the DELETE button to delete the currently selected song from the track list.

### 5 Move the cursor to the dotted frame in the track list, and use the [DATA/JOG] dial or the [INC]/[DEC] keys to select the song that will be written to track 1.

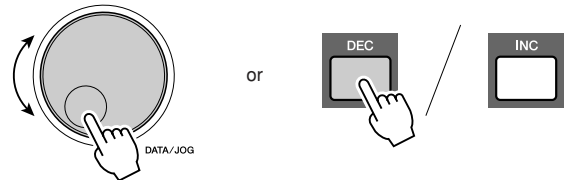
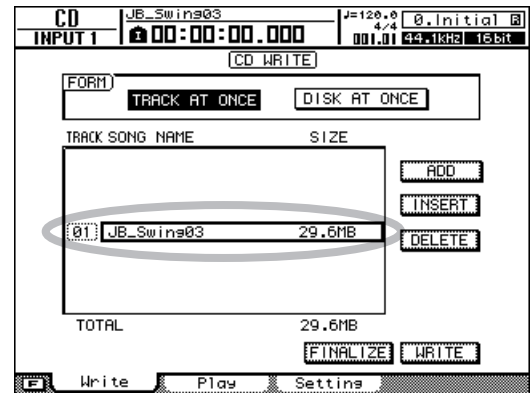

#### HINT

- Songs in which data has not been recorded on the virtual tracks selected for the stereo track will not be displayed. A current song that was not saved after the stereo track was recorded will also not be displayed.
- Songs with a stereo track shorter than four seconds will not be displayed.
- Songs with the sampling frequency of 48 kHz will not be displayed.

### 6 Repeat steps 4 and 5 to select the songs that will be written to track 2 and following.

#### HINT

- Pressing the [F1]–[F3] keys while holding the Display section [SHIFT] key has the same effect as the ADD ([F1] key), INSERT ([F2] key), and DELETE ([F3] key) buttons, respectively.

#### NOTE

- When you add a song to the track list, the added song will always be initially selected. Change this as required.

## 7 Move the cursor to the WRITE button and press the [ENTER] key.

A popup window will ask you to confirm.



### HINT

- Pressing the [F4] key while holding the Display section [SHIFT] key has the same effect as the WRITE button.

## 8 To begin writing the disc, move the cursor to the OK button and press the [ENTER] key.

A popup window will indicate “CD Writing...” while data is being written to the disc. When writing is completed, a popup window will ask you whether you want to finalize.



### NOTE

- A “BUFFER UNDERRUN!” error message will appear if a buffer underrun occurs while writing. In this case, either decrease the writing speed to 4x or set the UNDERRUN PROTECT button to ENABLE (→ p. 215).
- If you enabled the write test in “Basic settings for the CD-RW drive” (→ p. 215), a write test will be performed before the data is actually written. An error message will appear if a problem occurs during the write test.
- Copy-prohibit data will automatically be written into the CD that is created.

## 9 To finalize the disc, move the cursor to the OK button and press the [ENTER] key.

If you do not want to finalize the disc, move the cursor to the CANCEL button and press the [ENTER] key.

This completes the writing process.

## Writing Disc At Once

Here’s how to use the Disc At Once method to write stereo tracks from songs saved on the hard disk to CD-R/RW media. Use this method if you do not want to create silence between each track of the CD, or if you want to write a single song divided into multiple tracks on the CD.

### 1 Make sure that the appropriate virtual track is selected for the stereo track of the song(s) you want to write.

### 2 If you want to divide the song into CD tracks at the marker locations specified within the song, check that markers have been set at the appropriate locations.

### 3 Call the CD screen Write page by either pressing the Work Navigate section [CD] key as many times as necessary, or by pressing the [F1] key after pressing the [CD] key.

### 4 Move the cursor to DISC AT ONCE and press the [ENTER] key.

The CD-RW disc inserted in the drive will automatically be checked.

### HINT

- If data has already been written on the CD-RW disc that you insert, a popup window will appear immediately after step 4 asking whether you want to erase the data. Move the cursor to the OK button if you want to erase the entire disc, or to the CANCEL button if you want to cancel execution. Then press the [ENTER] key.

### 5 Move the cursor to the ADD button and press the [ENTER] key.

The track list will show information (track number/ song name/size of the stereo track) for the song that will be written to track 1 of the CD.

### HINT

- When you move the cursor to the ADD button and press the [ENTER] key, a new song will be added following the existing songs.
- By using the INSERT button instead of the ADD button, you can insert a new song immediately before the song that is selected in the list.
- You can use the DELETE button to delete the currently selected song from the track list.

- 6** Move the cursor to the dotted frame in the track list, and use the [DATA/JOG] dial or the [INC]/[DEC] keys to select the song that will be written to track 1.

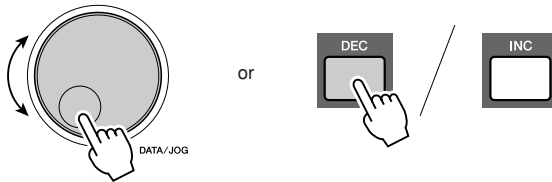
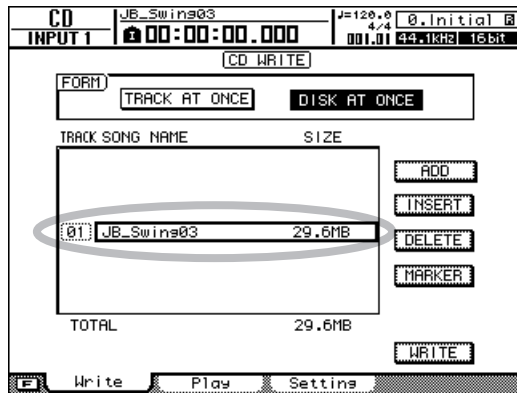

**HINT**

- Songs in which data has not been recorded on the virtual tracks selected for the stereo track will not be displayed. A current song that was not saved after the stereo track was recorded will also not be displayed.
- Songs with a stereo track shorter than four seconds will not be displayed.
- Songs with the sampling frequency of 48 kHz will not be displayed.

- 7** If you want the stereo track of the selected song to be divided into CD tracks at the location of each marker, move the cursor to the MARKER button and press the [ENTER] key.

Markers will be enabled for that song, and a “flag” icon will appear at the right of the list.

**HINT**

- Markers can be enabled/disabled independently for each song.
- When you use markers to divide a stereo track, the location of the divisions will be specified in units of 1/75 second.

**NOTE**

- Note that if markers are enabled, the track numbers shown in the list will not match the number of tracks written to the CD.
- A maximum of 99 tracks can be written to an audio CD. If, for example, markers are enabled for the song you write to CD track 1, and this song contains 98 markers, it will not be possible to write any more songs to that CD-R/RW disc.

- 8** Repeat steps 5–7 to select the songs that will be written to track 2 and following.

**HINT**

- Pressing the [F1]–[F3] keys while holding the Display section [SHIFT] key has the same effect as the ADD ([F1] key), INSERT ([F2] key), and DELETE ([F3] key) buttons, respectively.

**NOTE**

- When you add a song to the track list, the added song will always be initially selected. Change this as required.

- 9** Move the cursor to the WRITE button and press the [ENTER] key.

A popup window will ask you to confirm.



**HINT**

- Pressing the [F4] key while holding the Display section [SHIFT] key has the same effect as the WRITE button.

- 10** To begin writing the disc, move the cursor to the OK button and press the [ENTER] key.

A popup window will indicate “CD Writing...” while data is being written to the media. When writing is completed, the CD-R/RW media will be ejected, and the following popup window will appear.



**NOTE**

- If you enabled the write test in “Basic settings for the CD-RW drive” (→ p. 215), a write test will be performed before the data is actually written. An error message will appear if a problem occurs during the write test.
- Copy-prohibit data will automatically be written to the CD.

- 11** If you want to create another CD with identical contents, insert a new disc, and move the cursor to the OK button and press the [ENTER] key.

Writing will begin again. Alternatively, you can move the cursor to the CANCEL button and press the [ENTER] key to exit the write operation.

## Finalizing CD-R/RW media

Here's how to finalize CD-R/RW media created using Track At Once so that the disc can be played by a CD-RW drive or a CD player.

### HINT

- CD-R/RW media written by the AW2400 using Track At Once (and not yet finalized) cannot be played by another CD-RW drive or a CD player, but it can be played by the AW2400's CD Play function. (→ p. 222)

**1** Insert the CD-R/RW disc that you want to finalize into the CD-RW drive.

**2** Call the CD screen Write page by either pressing the Work Navigate section [CD] key as many times as necessary, or by pressing the [F1] key after pressing the [CD] key.

**3** Move the cursor to the TRACK AT ONCE button, and press the [ENTER] key.

The track list will show the tracks that have been written to that CDR/RW disc. Already-recorded tracks will be displayed as "--EXIST--".

**4** Move the cursor to the FINALIZE button, and press the [ENTER] key.

A popup window will ask you to confirm the finalize operation.



**5** To finalize the disc, move the cursor to the OK button and press the [ENTER] key.

If you decide not to finalize the disc, move the cursor to the CANCEL button and press the [ENTER] key.

### NOTE

- The finalize operation cannot be halted once it has been started. Perform this operation with care.

## Erasing CD-RW media

Here's how to erase all data that has been written to CD-RW media so that the CD-RW disc can be used to record new data. You will need to perform this operation on a disc that has been used to store data from a computer or other equipment if you want to use that disc with the AW2400.

### HINT

- Since data is erased as necessary when you back up AW2400 data to CD-RW media or when you write audio data to CD-RW media, you do not need to perform the following procedure each time you re-use the disc.

### NOTE

- The erased data cannot be recovered. Perform this operation with care.

**1** Call the CD screen Setting page by either pressing the Work Navigate section [CD] key as many times as necessary, or by pressing the [F3] key after pressing the [CD] key.

**2** Move the cursor to the CD-RW MEDIA ERASE field, and press the [ENTER] key to select the desired erasure method.

The buttons select the following erasure methods.

- **SIMPLY button**.....Only the TOC (Table Of Contents) data written to the CD-RW disc will be erased. This is the quickest way to erase a CD-RW disc.
- **PERFECTLY button**...All data written to the CD-RW disc will be erased completely. This method erases all data from the media and thus will take longer than the SIMPLY option.

Move the cursor to the appropriate button and press the [ENTER] key. A popup window will ask you to confirm the erasure.

● If you turn on the SIMPLY button



● If you turn on the PERFECTLY button



### HINT

- Pressing the [F1]–[F2] keys while holding the Display section [SHIFT] key has the same effect as the SIMPLY ([F1] key) and PERFECTLY ([F2] key) buttons, respectively.

**3** To execute the erasure move the cursor to the OK button. If you decide not to erase the disc move the cursor to the CANCEL button. Then press the [ENTER] key.

Erasure will begin if you selected the OK button. (This operation cannot be halted.)

# Playing an audio CD

The AW2400 CD Play function lets you play back a conventional audio CD or CD-R/RW media to which audio data has been written via the CD-RW drive.



- The CD Play function can also be used to play mixed-mode CDs (tracks 2 and above) and CD Extra CDs (1st session only).
- CD-R/RW discs can also be played prior to finalization.

**1** Call the CD screen Play page by either pressing the Work Navigate section [CD] key as many times as necessary, or by pressing the [F2] key after pressing the [CD] key.

In this page you can play back an audio CD inserted in the CD-RW drive.

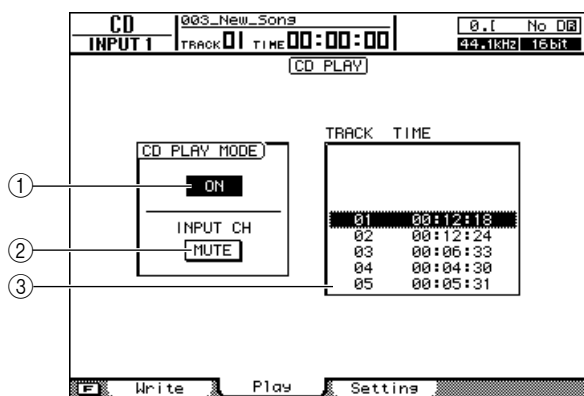

- ① CD PLAY MODE button**  
Switches the CD Play function on/off.
- ② INPUT CH MUTE/MIX button**  
Use this button to specify whether the signals from input channels 1–16 will be output together with CD playback (MIX button), or whether only the CD signal will be output (MUTE button).
- ③ List**  
Displays the tracks on the audio CD that is inserted in the CD-RW drive.

**2** Insert the audio CD that you want to play into the CD-RW drive.

**3** Move the cursor to the CD PLAY MODE button and press the [ENTER] key.

The CD Play function will be activated, and the CD track data will be read.



- Pressing the [F1] key while holding the Display section [SHIFT] key has the same effect as the CD PLAY MODE button.

**4** To play the CD tracks, press the PLAY [▶] key. To stop, press the STOP [■] key.

During playback the audio output of the CD-RW drive will be sent directly to the stereo output channel. Use the STEREO fader to adjust the volume.

When the CD Play function is on, the transport section keys have the following functions.

Key	Operation
PLAY [▶] key	Play
STOP [■] key	Stop
REW [◀◀] key/FF [▶▶] key	Rewind/Fast-forward
[DATA/JOG] dial	Select tracks (Press the [ENTER] key to confirm the selection)
[ ◀] key/[▶ ] key	Select tracks

**5** To exit the CD Play function, move the cursor to the CD PLAY MODE button and press the [ENTER] key.



- The CD PLAY MODE button can be switched on/off only while CD playback is stopped.
- While the CD PLAY MODE button is on, the CD-RW drive will be locked and it will not be possible to eject the disc.

# Digital Input/Output & Optional Card Settings

This section covers settings that apply to digital I/O and optional I/O cards.

## Wordclock and Cascade Settings

Wordclock source selection and settings for Vari-pitch and cascade connection are made via the DIO screen Setting page.

To call this page press the Work Navigate section [DIO] key as many times as necessary, or press the [F1] key after pressing the [DIO] key.

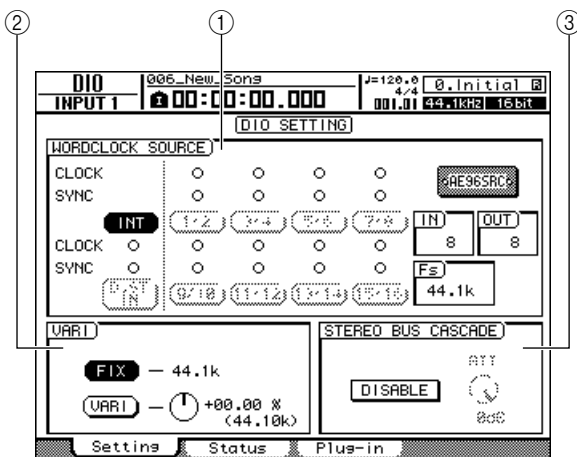

This page includes the following items.

- ① **WORDCLOCK SOURCE field**  
Selects the wordclock source to which the AW2400 will synchronize. The condition of the received wordclock and synchronization status are also displayed here.
- ② **VARI field**  
Provides fine adjustment of the internal clock in order to control the Vari-pitch function.
- ③ **STEREO BUS CASCADE field**  
Provides settings that allow an external device connected to the [DIGITAL STEREO IN] connector to cascade-connected to the AW2400 stereo bus.

### Select the Wordclock Source

“Wordclock” refers to the clock signal that provides the basic timing for all digital audio signals. When transferring digital audio signals between the AW2400 and an external device such as a computer-based DAW (Digital Audio Workstation) or HDR (Hard-Disk Recorder) it is necessary to ensure that both devices are synchronized by the same wordclock signal. If the wordclock used by the two devices is not perfectly synchronized the digital audio cannot be accurately transferred and severe noise will often be the result.

The normal procedure is to designate one device that will be the source of the wordclock signal for the entire system as the “wordclock master,” or simply “clock master”, and all devices that receive and synchronize to the wordclock master as “wordclock slaves”. The AW2400 can be set to function either as the wordclock master or slave.

- 1 **Call the DIO screen Setting page by either pressing the Work Navigate section [DIO] key as many times as necessary, or by pressing the [F1] key after pressing the [DIO] key.**

Wordclock settings are made in the WORDCLOCK SOURCE field.

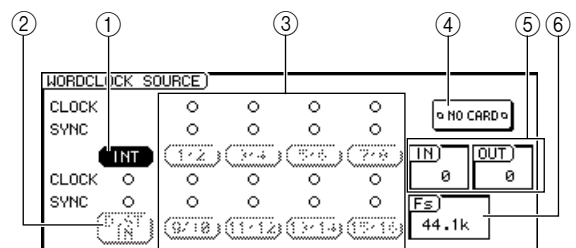

① **INT button**

When this button is on the AW2400's internal clock is selected as the wordclock source. Use this setting when using the AW2400 on it's own, or when using the AW2400 as the wordclock master for other devices.



- When the internal clock is selected the sampling frequency of the current song becomes the sampling frequency for the entire system.

② **D.ST IN button**

When this button is turned on the clock signal included in the digital audio signal received at the [DIGITAL STEREO IN] connector is used as the wordclock source.

Use this setting when you want the AW2400 to function as a wordclock slave that synchronizes to the signal received via the [DIGITAL STEREO IN] connector. Choose this setting when, for example, you will be cascade-connecting the digital audio from an external device to the AW2400 stereo bus, or when receiving digital audio from a DAT recorder or similar digital audio source.

③ **1/2–15/16 buttons**

When one of these buttons is turned on the clock signal included in the corresponding digital audio signal received via the rear-panel slot is used as the wordclock source (i.e. the clock signal included in one stereo pair: 1/2, 3/4–15/16).

Use one of these settings when using an external HDR or other digital audio source as the wordclock master to which the AW2400 will be synchronized as the wordclock slave.

The CLOCK and SYNC rows show the condition of the received wordclock signal and the synchronization status, respectively.

- **CLOCK** ... A “●” symbol will appear when an appropriate wordclock signal is detected.
- **SYNC** ..... A “●” symbol will appear when the AW2400 is properly synchronized to the incoming wordclock signal. A “○” symbol will appear when an appropriate wordclock signal is not detected.



- Buttons that appear gray indicate that an appropriate digital signal is not available at the corresponding connector or slot, and cannot be used.

④ **SLOT**

When an I/O card is installed in the rear-panel slot a graphic symbol that indicates the type of card will appear here. “NO CARD” will appear when no card is installed.

⑤ **IN, OUT**

Indicates the number of input channels (IN) and output channels (OUT) available on an I/O card installed in the rear-panel slot.

⑥ **Fs**

Indicates the sampling frequency of the wordclock signal currently selected as the wordclock source.



- When using the AW2400 as wordclock slave, check that the sampling frequency of the current song matches the sampling frequency shown in the Fs field. For example, a song that was recorded with a sampling frequency of 44.1 kHz will play back with the wrong pitch and tempo if slaved to a 48 kHz wordclock signal.
- “Unlock” in the Fs field indicates that proper synchronization with the wordclock source has not been achieved. In such cases check that an appropriate wordclock signal has been selected as the source.



## 2 Select a wordclock source via the WORDCLOCK SOURCE field.

The wordclock source setting will depend on how the AW2400 is being used. Here are a few examples.

### ● AW2400 As Wordclock Master

When the AW2400 is used on its own, or when it is used as the wordclock master for an external HDR, DAW, or similar digital audio device, turn the INT button on. The external device(s) must be set to synchronize to the master wordclock from the AW2400.

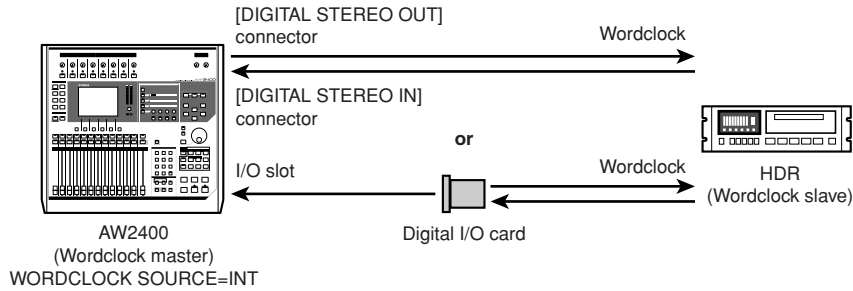

### ● Using an HDR or DAW As Wordclock Master

Set the HDR or DAW to use its internal clock in order to function as wordclock master so that the AW2400 can synchronize to the digital signal received at a digital input on an I/O card. Select the 1/2–15/16 button corresponding to the digital input at which the master signal is being received.

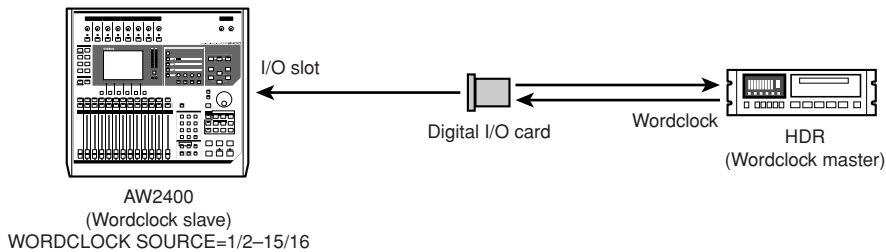

### ● Using an MD or DAT Recorder as Wordclock Master

Connect the digital audio output of the MD or DAT recorder to the AW2400 [DIGITAL STEREO IN] connector, and turn the D.ST IN button on so that the AW2400 can synchronize to the received digital signal.

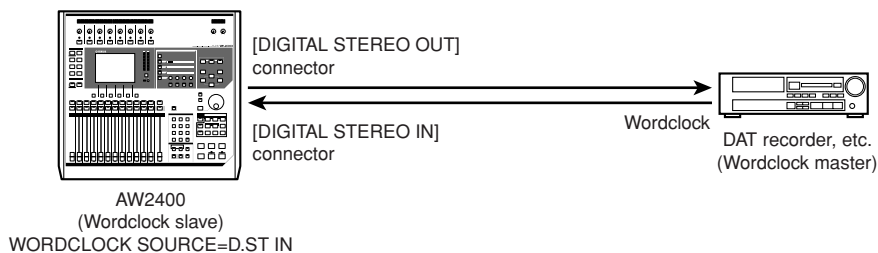

## 3 Move the cursor to the appropriate button and press the [ENTER] key.

The AW2400 clock source will change accordingly, and the sampling frequency of the selected clock source will appear in the Fs field.

## Fine Adjustment Of Overall Song Pitch (Vari-pitch)

When the AW2400 is set to use its own internal clock as the wordclock source it is possible to adjust the sampling frequency over a small range to adjust the pitch and tempo of song playback (Vari-pitch). This function can be useful to match the playback pitch of an AW2400 song to an acoustic instrument, or to adjust the length of a song.

- 1 Call the DIO screen Setting page by either pressing the Work Navigate section [DIO] key as many times as necessary, or by pressing the [F1] key after pressing the [DIO] key.
- 2 Move the cursor to the WORDCLOCK SOURCE field INT button and press the [ENTER] key.  
This selects the AW2400 internal clock as the wordclock source.
- 3 Move the cursor to the VARI field.  
Vari-pitch settings are made via the VARI field.

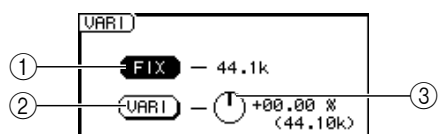

- 1 **FIX button**  
When this button is turned on the sampling frequency is fixed at the sampling frequency shown to the right of the button (default).
- 2 **VARI button**  
The Vari-pitch function is active when this button is turned on.
- 3 **VARI knob**  
Adjusts the sampling frequency of the current song in a range of -5.97 to +6.00%.
- 4 Move the cursor to the VARI button and press the [ENTER] key.  
This activates the Vari-pitch function.
- 5 Move the cursor to the VARI knob and use the [DATA/JOG] dial or [INC]/[DEC] keys to set the sampling frequency as required.

- 6 To disable the Vari-pitch function move the cursor to the FIX button and press the [ENTER] key.

The Vari-pitch function will be turned off and the sampling frequency will be fixed at the value shown to the right of the FIX button.

**NOTE**

• When the Vari-pitch function is enabled and sampling frequency is adjusted, any external devices slaved to the AW2400 wordclock signal will be affected. Some slave devices may not be able to synchronize properly to the AW2400 wordclock signal when it is adjusted using the Vari-pitch function.

## Cascade-connecting External Devices

Digital audio signals received at the AW2400 [DIGITAL STEREO IN] connector can be mixed directly into the AW2400's stereo bus (cascade connection). The output from a digital mixer could be cascade-connected in this way to allow the mixer's inputs to be mixed to stereo along with the AW2400's own inputs.

### ● AW2400 Cascade Connection

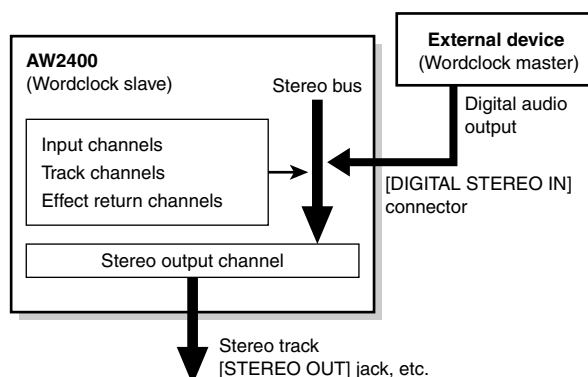

- 1 Connect the digital output from the device to be cascade connected to the AW2400 [DIGITAL STEREO IN] connector.
- 2 Call the DIO screen Setting page by either pressing the Work Navigate section [DIO] key as many times as necessary, or by pressing the [F1] key after pressing the [DIO] key.
- 3 Move the cursor to the D.ST IN button in the WORDCLOCK SOURCE field and press the [ENTER] key.

This selects the signal received at the [DIGITAL STEREO IN] connector as the wordclock source.

**4 Move the cursor to the STEREO BUS CASCADE field.**

Cascade connection settings are made in the STEREO BUS CASCADE field.

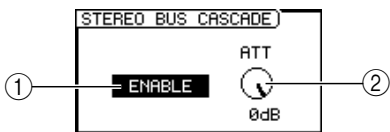

① **STEREO BUS CASCADE button**  
Enables or disables the cascade connection.

② **ATT knob**  
Adjusts the level of the signal received at the [DIGITAL STEREO IN] connector.

**5 Move the cursor to the STEREO BUS CASCADE button and press the [ENTER] key.**

This connects the digital audio signal received from the external device directly to the AW2400 stereo bus.

**6 Use the ATT knob to adjust the level of the received digital signal as required.**

You can now mix and record the signals from the AW2400's own inputs along with the digital audio received at the [DIGITAL STEREO IN] connector to the AW2400 stereo track.

**NOTE**

- In order to record the signal received at the [DIGITAL STEREO IN] connector the UTILITY screen Preference page CD/DAT DIGITAL REC button must be set to ENABLE.

## Check the Status Of the Digital Input Signal

You can visually check the status of the signals received at the [DIGITAL STEREO IN] connector as well as signals received via an I/O card installed in the rear-panel slot in the DIO screen Status page.

To call this page press the Work Navigate section [DIO] key as many times as necessary, or press the [F2] key after pressing the [DIO] key. This is a display-only page that does not include any editable settings.

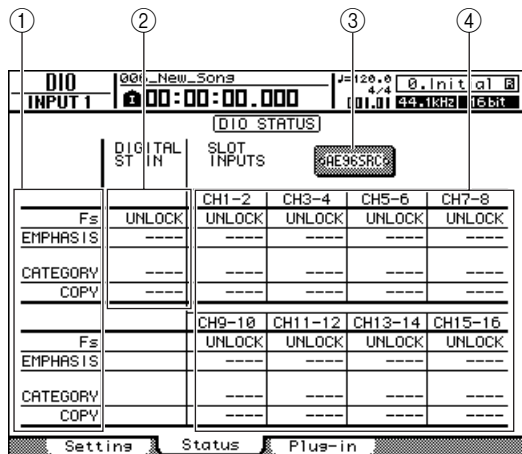

This page contains the following items.

① **Status**

Indicates the status of received digital signals. The meanings of the displays are as follows:

**NOTE**

- The following status displays will appear as "----" when a MY8-AT, MY8-TD, MY16-AT, or MY16-TD I/O card is installed.

• **Fs (Sampling Frequency)**

Indicates the sampling frequency of the received digital signal.

Parameter values	Description
44.1k	Sampling frequency = 44.1kHz
48k	Sampling frequency = 48kHz
None	Unknown sampling frequency
UNLOCK	No input signal, or inappropriate input signal.

• **EMPHASIS**

Indicates whether emphasis is on or off for the received digital signal.

Parameter values	Description
On	Emphasis ON
Off	Emphasis OFF
???	Unknown

• **CATEGORY**

Indicates the status of “Category Code Bit” included in the IEC958 Part 2 (S/PDIF-Consumer) format. This parameter can display the following values:

Parameter values	Description
General	Temporarily used.
Laser Optical	Laser optical device
D/D Conv	Digital - Digital converter and signal processing device
Magnetic	Magnetic tape device and magnetic disk device
D.Broadcast	Digital broadcast reception
Instrument	Musical instrument, microphone, and sources that generate string signals
AD Conv	A/D converter (without copyright information)
AD Conv with (c)	A/D converter (with copyright information)
Solid Memory	Solid memory device
Experiment	Experimental device
Unknown	Unknown device

**NOTE**

- “AES/EBU” appears in the Category row when you are monitoring IEC958 Part 3 (AES/EBU-Professional) format signals (that do not include Category Code Bit).

• **COPY**

Indicates the status of copy protection information included in the IEC958 Part2 (S/PDIF-Consumer) format signals.

Parameter values	Description
OK	Copy allowed
Prohibit	Copy prohibited

② **[DIGITAL STEREO IN] connector status**

Indicates the status of the digital audio signal received at the [DIGITAL STEREO IN] connector.

③ **SLOT**

When an I/O card is installed in the rear-panel slot a graphic symbol that indicates the type of card appears here. “NO CARD” will appear when no card is installed.

④ **Digital I/O card status**

Displays the status of the digital audio signal received via a digital I/O card.

**HINT**

- The status of digital signals received via a digital I/O card is displayed in odd/even channel pairs.

## Plug-in Card Settings

Settings for plug-in DSP cards installed in the rear-panel slot are made via the DIO screen Plug-in page.

To call this page press the Work Navigate section [DIO] key as many times as necessary, or press the [F3] key after pressing the [DIO] key.

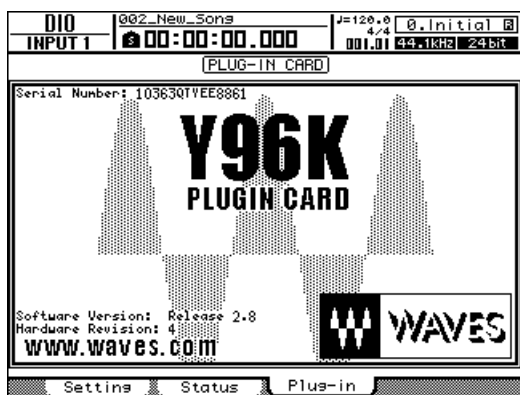

The content of the display will depend on the plug-in card installed. Refer to the plug-in card owner’s manual for details.

As of July 2005 the available plug-in card is:

- **Waves** ..... Y96K

Check the following Yamaha website for the latest information on plug-in cards.

<http://www.yamahaproaudio.com/>

# ◆ Chapter 24 ◆

## USB

This chapter explains operation and use of the AW2400 USB interface.

### What You Can Do With USB

The AW2400 USB interface can be connected to a personal computer to allow data transfer between the AW2400 and the computer. The following types of operation are possible.

#### ● MIDI Message Transfer (Normal Mode)

In this type of operation the USB connector performs the functions of the three MIDI connectors usually used for MIDI data transfer, allowing efficient MIDI communication with the computer. The USB port is normally in this mode immediately after the AW2400 power is turned on.

##### NOTE

- In order to use the USB connector for MIDI communication the MIDI port settings must be correct. Refer to "Basic MIDI Settings" on page 194 for details on the MIDI port settings.
- Before connecting the AW2400 USB connector to the computer the appropriate USB-MIDI driver must be properly installed on the computer (→ p. 266).

#### ● WAV File Transfer (USB Storage Mode)

Audio data recorded on the AW2400 can be transferred to the computer in the form of WAV files for storage or further manipulation. Conversely, WAV files can be transferred to the AW2400 from the computer. For example, you might transfer a recording made on the AW2400 to the computer and use a computer-based waveform editing program to edit the waveform. Once edited the WAV file can be transferred back to the AW2400 where it can be processed and mixed with other audio data. It is also possible to directly access data on the internal AW2400 hard disk from the computer and directly edit the data "in place".

##### NOTE

- Either the Windows XP SP1 or Mac OS X 10.3 or higher operating system is required for computer WAV file management with the AW2400.

#### ● USB Storage mode

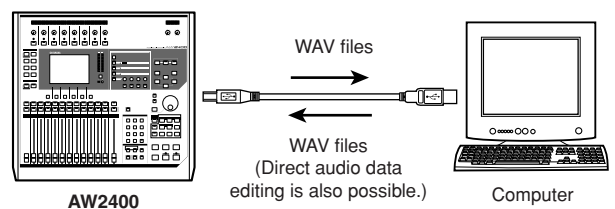

# WAV File Transfer (USB Storage Mode)

In this mode you can directly access the AW2400 hard disk from the computer to manipulate and manage the audio data (WAV files). The following two methods can be used.

## ■ Using the Transport Folder

This method uses the “Transport” folder on the AW2400 as the transit point for transferring files to and from the computer.

WAV files are first exported to the “Transport” folder on the AW2400 hard disk from the audio tracks. The AW2400 is then connected to the computer via a USB cable, the “Transport” folder is accessed and opened from the computer, and the WAV files are copied to the computer hard disk. Files to be moved from the computer to the AW2400 are first copied from the computer to the AW2400 “Transport” folder, and then imported into the audio tracks from there.

### ● Transfer to Computer via the “Transport” Folder

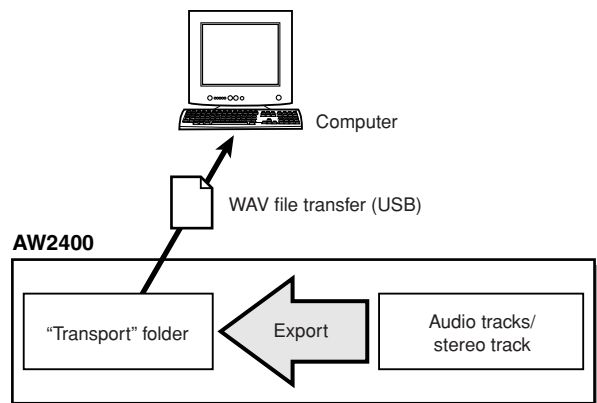

**HINT**

• Files in the “Transport” folder can also be directly accessed and manipulated from applications running on the computer.

### ● Transfer to AW2400 via the “Transport” Folder

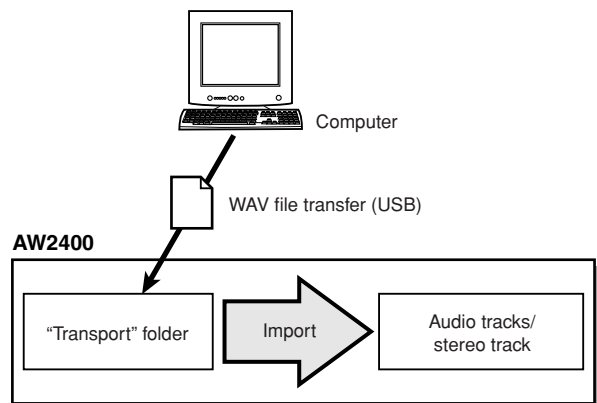

## ■ Directly Accessing AW2400 Audio Data

In this case the AW2400 and computer are connected via a USB cable, and the target WAV files in specific folders on the AW2400 hard disk are directly accessed from the computer. Waveform editing software running on the computer can be used to directly edit WAV files residing on the AW2400 hard disk, and complete songs can be backed up (copied to) the computer hard disk. Refer to “Song Folder Organization” on page 166 for details on how the folders are organized.

### ● Directly Accessing Audio Data

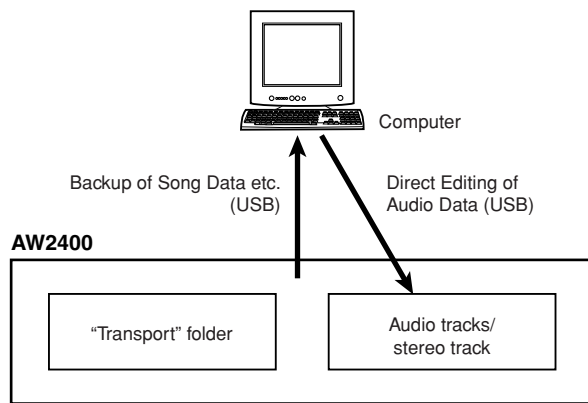

## Switching to the USB Storage Mode

To directly access files on the AW2400 internal hard disk, first follow the procedure outlined below to switch to the USB Storage Mode.

### 1 Make sure that your computer meets the following requirements.

- OS ..... Windows XP Professional/ Home Edition SP1 or higher, or Mac OSX 10.3 or higher.
- USB Interface ..... USB 2.0

**NOTE**

- A USB 1.1 interface can also be used, but in that case file transfer will occur at USB 1.1 speed.
- To use Mac OS X 10.3 you will need to re-initialize the AW2400 hard disk and set the hard disk cluster size to 32K (→ p. 212).

### 2 Make sure the POWER switch on the AW2400 is set to OFF, then connect the AW2400 to the computer via a USB cable.

### 3 Turn on the AW2400.

No driver installation is necessary for WAV file transfer. If it is the first time you have connected a USB cable on a Windows machine, however, you may see a message prompting you to install a USB MIDI driver. Even if you will not send and receive MIDI messages via the USB cable, install the USB MIDI driver as described on page 266.

### 4 Call the USB screen USB page by pressing the SCENE/AUTOMIX/USB section [USB] key.

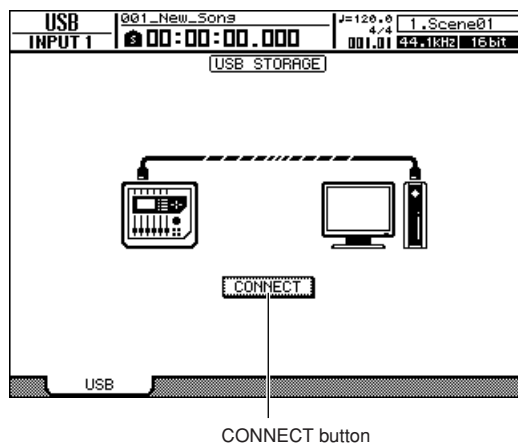

### 5 Move the cursor to the CONNECT button, and press the [ENTER] key.

A popup window will ask you whether you want to save the current song.

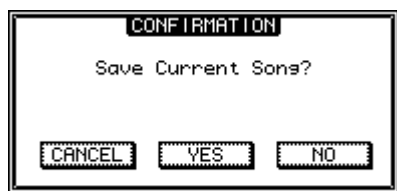

#### NOTE

- Before turning the USB Storage Mode on, make sure that no MIDI data is being transferred via the USB connection with your computer.

### 6 Move the cursor to YES (to save the current song) or NO (if you don't want to save the current song) and press the [ENTER] key.

The AW2400 USB Storage Mode will be engaged, and the button will change to "CANCEL". Most of the AW2400 functions are temporarily disabled while this mode is engaged.

### 7 Display the AW2400 internal hard disk on the computer screen.

#### ● In the case of Windows XP:

The two windows will appear.



#### NOTE

- If the windows shown above do not appear, choose to display the "AW2400-1" and "AW2400-2" drives from the Windows Start → My Computer menu.

#### ● In the case of Mac OS X:

The "AW2400-1" and "AW2400-2" drive icons will appear on the desktop.

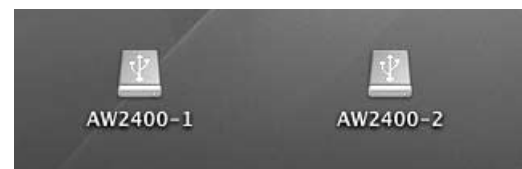

#### NOTE

- If the icons are not displayed properly, use the Disk Utility to temporarily un-mount the appropriate volume, and then mount it again.

## 8 Open the appropriate drive/folder and copy the required WAV files or directly edit the WAV files using a waveform editor application.

To access the Transport folder open the “AW2400-2” drive.

To directly access WAV files on the AW2400 open the “Song1” folder on the “AW2400-1” drive and the “Song2” folder on the “AW2400-2” drive. These folders contain folders bearing the names of the recorded songs (extension .AWS), and those folders further contain folders labeled “Audio” that contain the actual audio data.

To backup a complete song to the computer simply copy the folder bearing the name of the song you want to backup to the computer.

Refer to “Song Folder Organization” on page 166 for information on how the folders are organized.

### HINT

- Verification and repair of the internal hard disk can be carried out from the computer. From a Windows computer enter the “chkdsk” command at the command prompt, or from a Macintosh computer running OS X use the Disk Utility First Aid function.

### NOTE

- For 24-bit songs, the audio data contained in the “Audio” folders is stored in 32-bit WAV format. If your waveform editor application cannot handle 32-bit data, first export the WAV file(s) to the “Transport” folder. WAV files imported or exported via the “Transport” folder are automatically converted to 24-bit format that can be edited using most waveform editor software.
- Do not change the names of any folders/files other than those in the Transport folder. Any folder/file names that have been added or changed outside the Transport folder from the computer will be automatically deleted. Be especially careful not to change a song folder or song file name.
- Files larger than 4 GB cannot be copied.

Be sure to carry out the steps outlined in “Exiting the USB Storage Mode” when disconnecting the AW2400 from the computer.

## Exiting the USB Storage Mode

Use the following procedure to exit from the USB Storage Mode.

### 1 Be sure the “unmount” the AW2400 hard disk from your computer after closing all AW2400 windows.

#### ● In the case of Windows XP:

Click the “Safely Remove Hardware” icon in the taskbar and remove the corresponding two “USB mass storage devices”.



### NOTE

- If an error message appears, execute “Safely Remove Hardware” one or two more times. You should then be able to remove the device without seeing an error message.

#### ● In the case of Mac OSX:

Drag the “AW2400-1” and “AW2400-2” icons from the desktop to the trash.

### 2 In the AW2400 screen, move the cursor to the CANCEL button and press the [ENTER] key.

A popup window confirming whether the AW2400 has been safely removed from the computer will appear.



### 3 To return to the normal mode move the cursor to the OK button and press the [ENTER] key.



## Copying Exported WAV Files To the Computer

The WAV files corresponding to the audio tracks you want to transfer to a computer must first be exported to the “Transport” folder on the internal hard disk drive. Once these files have been exported they can be edited using appropriate waveform editing software, or imported into a DAW application for further processing or integration with other projects.

- 1 Call the **EDIT** screen **Edit page** by either pressing the **Work Navigate** section **[EDIT]** key as many times as necessary, or by pressing the **[F1]** key after pressing the **[EDIT]** key.

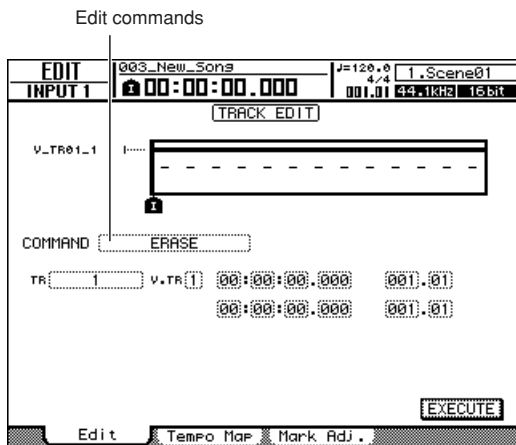

- 2 Move the cursor to the edit command field and use the **[DATA/JOG]** dial or **[INC]/[DEC]** keys to select **EXPORT**.
- 3 Press the **[ENTER]** key to confirm the selected edit command.

The display will appear as follows.

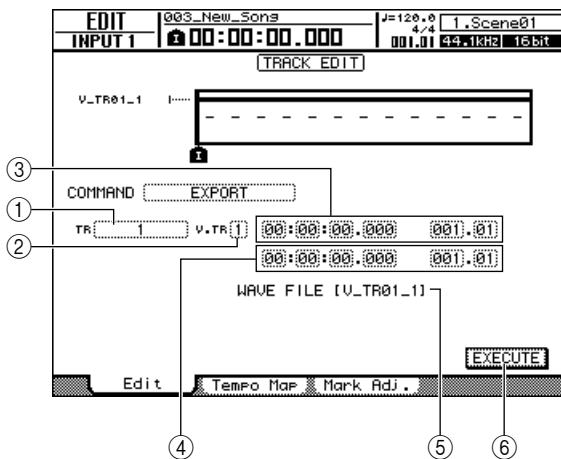

- 1 **From TR**

Selects the source track for the export operation (1–24, 1&2–23&24, ST, ALL).

- 2 **From V.TR**

Selects the source virtual track for the export operation (1–8).

- 3 **From Start**

Specifies the start point of the data to be exported in counter format.

- 4 **From End**

Specifies the end point of the data to be exported in counter format.

- 5 **File Name**

Displays the name of the WAV file to be exported. The default name is the name of the virtual track (the odd-numbered virtual track in track pairs) to be exported.

- 6 **EXECUTE button**

Executes the export operation.

- 4 Move the cursor to the **From TR** field, and select the audio track that you want to export.

If you select “ALL,” the current tracks 1–24 will be exported as separate monaural WAV files.

If you select “1”–“24,” the single specified track will be exported as a monaural WAV file.

If you select “1&2”–“23&24” or ST, the specified pair of tracks (or the Stereo track) will be exported as a stereo WAV file.

- 5 Move the cursor to the **From V.TR**, **From Start**, and **From End** fields, and specify the virtual track number and region to be exported.

**NOTE**

- If you selected “ALL” as the export source, all the recorded tracks will be exported automatically. It is not possible to specify the virtual track number for each.

**6** When you have finished setting the parameters, move the cursor to the EXECUTE button and press the [ENTER] key.

If a source other than “ALL” is selected the NAME EDIT popup window will appear, allowing you to enter a file name.

If you select “ALL” as the source the NAME EDIT popup window will appear, allowing you to enter a folder name. The WAV files (“TRACK\_01.WAV”–“TRACK\_24.WAV”) will be stored in the new folder, which will be created inside the “Transport” folder.

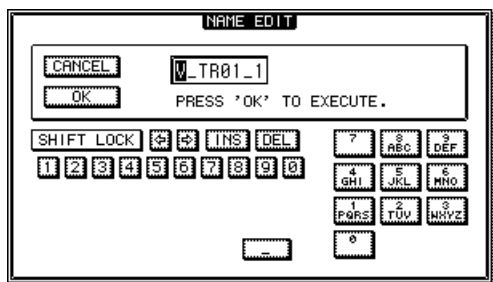

**7** Enter an appropriate file or folder name via the NAME EDIT popup window, as required.

For details on how to enter a name, refer to page 32.

**8** To execute the export operation, move the cursor to the OK button and press the [ENTER] key.

The export operation will begin. If you move the cursor to the CANCEL button (instead of the OK button) and press the [ENTER] key, the export operation will be cancelled. (However, it is not possible to abort the export process once it has been started.)

**NOTE**

- Since the AW2400 does not keep track of the date and time, dummy values will be written as the file creation date and time of the WAV files.
- Tracks that do not contain data in the specified region will not be exported.

**9** Switch to the USB Storage Mode (→ p. 230) and display the AW2400 internal hard disk on the computer screen.

**10** Open the “AW2400-2” drive to access the “Transport” folder.

**11** Copy the WAV files exported to the “Transport” folder to the computer.

WAV files in the “Transport” folder can also be directly accessed from computer applications.

**12** When the files have been copied, disconnect the AW2400 from the computer and exit the USB Storage Mode (→ p. 232).

## Importing Copied WAV Files From the Computer

This procedure allows you to import WAV files transferred from a computer to the “Transport” folder to be imported into specified audio tracks.

**1** Switch to the USB Storage Mode (→ p. 230) and display the AW2400 internal hard disk on the computer screen.

**2** Copy the WAV files from the computer to the AW2400 “Transport” folder.

The “Transport” folder is located in the “AW2400-2” drive.

**3** When the files have been copied, disconnect the AW2400 from the computer and exit the USB Storage Mode (→ p. 232).

**4** Call the EDIT screen Edit page by either pressing the Work Navigate section [EDIT] key as many times as necessary, or by pressing the [F1] key after pressing the [EDIT] key.

**5** Move the cursor to the edit command field and use the [DATA/JOG] dial or [INC]/[DEC] keys to select IMPORT USB WAV.

**6** Press the [ENTER] key to confirm the selected edit command.

The display will appear as follows.

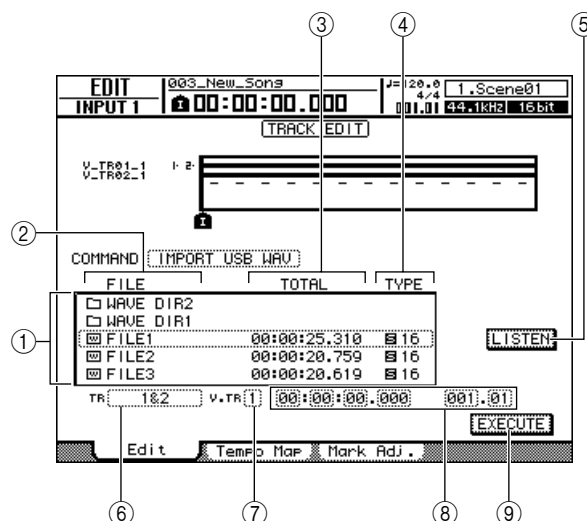



**① File list**

This shows the WAV files and folders (directories) in the "Transport" folder. Move the cursor to the list, and use the [DATA/JOG] dial or the [INC]/[DEC] keys to specify the WAV file that you want to import.

**② FILE**



This indicates the name of the WAV file or folder. The icons shown here have the following meaning.

-  ..... Indicates a WAV file.
-  ..... Indicates a folder in the same level. You can select this icon and press the [ENTER] key to move down one level.
-  ..... You can select this icon and press the [ENTER] key to move up one level.

**③ TOTAL**

Indicates the playback length (in units of hours/minutes/seconds/milliseconds) of the WAV file selected for importing. This field is for display only, and cannot be changed.

**④ TYPE**

Indicates whether the WAV file selected for importing is monaural () or stereo (). The numerical value at the right indicates the bit depth of the WAV file. This field is for display only, and cannot be changed.

**⑤ LISTEN/ENTER/UP button**

This display will change according to the selected file or folder in the file list.

- **LISTEN** ..... If a WAV file is selected, you can move the cursor to this button and press the [ENTER] key to repeatedly hear the currently selected WAV file.
- **ENTER** ..... If a folder is selected, you can move the cursor to this button and press the [ENTER] key to move into that folder.
- **UP** ..... If the  icon is selected, you can move the cursor to this button and press the [ENTER] key to move up one folder.

**⑥ To TR**

Selects the track number into which the WAV file will be imported. If the import source is a stereo WAV file, only tracks 1&2-23&24 can be selected.

**⑦ To V.TR**

Selects the virtual track number (1-8) into which the WAV file will be imported.



**⑧ To Start**

Specifies the start location (in counter-display and measure/beat format) to which the WAV file will be imported.

**⑨ EXECUTE button**

Executes the import operation.

**7 Move the cursor to the file list and use the [DATA/JOG] dial or [INC]/[DEC] keys to select the WAV file that you want to import.**

When a  is included in the field enclosed by the dotted frame you can press the [ENTER] key to move down one level. To move up one level display the  icon and press the [ENTER] key.

**NOTE**

- Only 16-bit or 24-bit, 44.1 kHz or 48 kHz, mono or stereo WAV files can be imported. Also, WAV files having a different bit depth or sample rate from the song cannot be imported.

**8 Use the To TR, To V.TR, and To Start fields to specify the track number, virtual track number, and starting location into which the WAV file will be imported.****NOTE**

- Any existing data at the import destination will be overwritten. Be careful not to accidentally overwrite important data.

**9 When you have finished making the required settings, move the cursor to the EXECUTE button and press the [ENTER] key.**

A popup window will ask you to confirm the operation.

**10 To execute the import operation, move the cursor to the OK button and press the [ENTER] key.**

The import operation will begin. If you move the cursor to the CANCEL button and press the [ENTER] key, the import operation will be cancelled.



# Appendix

## Mastering library list

No.	Name	Description
00	Initial Data	Initialize to a state in which EQ and DYN are not applied.
01	VITAL MIX	Standard mastering effect that enhances the overall loudness, creating a mix with extended low and high ranges. Use on the two-track mix for any type of song.
02	SOFT COMP	Soft compressor that enhances the overall loudness without greatly changing the original nuances (dynamics). Ideal for songs in which the mid and low ranges are important.
03	HARD ATTACKY	Limiter that emphasizes the attacks and produces an overall "flattened" feel. Ideal for songs that emphasize the rhythm.
04	SOFT ATTACKY	Soft compressor that enhances the overall loudness and emphasizes the attacks without greatly changing the original nuances (dynamics). Ideal for songs in which the low and mid ranges are important, and that emphasize the rhythm.
05	LO-FI	Limiter that produces a "lo-fi" character.
06	DARK/SOFT	Soft limiter that produces the slightly flattened feel characteristic of the 60's and 70's. (Ideal for Beatles-type rock of the 60's and 70's, or more recently for a Vincent Gallo feel.)
07	DARK/HARD	Hard limiter that produces a strongly flattened feel characteristic of the 60's and 70's. (Ideal when you want to make the song sound like 60's or 70's rock such as the Beatles.)
08	BRIGHT	Compressor that produces a boosted high range.
09	LO BOOST	Compressor that produces a boosted low range.
10	HARD LIMIT	Limiter that produces an extremely flattened feel. Ideal for hard-edged songs.
11	LIMITER	Limiter without EQ. Ideal when you need only limiting.
12	NARROW	Limiter that produces a sound like that of a small AM radio.
13	DIST	Limiter that distorts the sound within the effect.

## EQ Parameter list

#	Title	Parameter				
		LOW	L-MID	H-MID	HIGH	
01	Bass Drum 1		PEAKING	PEAKING	PEAKING	H.SHELF
		G	+3.5 dB	-3.5 dB	0.0 dB	+4.0 dB
		F	100 Hz	265 Hz	1.06 kHz	5.30 kHz
		Q	1.2	10	0.9	—
02	Bass Drum 2		PEAKING	PEAKING	PEAKING	LPF
		G	+8.0 dB	-7.0 dB	+6.0 dB	ON
		F	80 Hz	400 Hz	2.50 kHz	12.5 kHz
		Q	1.4	4.5	2.2	—
03	Snare Drum 1		PEAKING	PEAKING	PEAKING	H.SHELF
		G	-0.5 dB	0.0 dB	+3.0 dB	+4.5 dB
		F	132 Hz	1.00 kHz	3.15 kHz	5.00 kHz
		Q	1.2	4.5	0.11	—
04	Snare Drum 2		L.SHELF	PEAKING	PEAKING	PEAKING
		G	+1.5 dB	-8.5 dB	+2.5 dB	+4.0 dB
		F	180 Hz	335 Hz	2.36 kHz	4.00 kHz
		Q	—	10	0.7	0.1
05	Tom-tom 1		PEAKING	PEAKING	PEAKING	PEAKING
		G	+2.0 dB	-7.5 dB	+2.0 dB	+1.0 dB
		F	212 Hz	670 Hz	4.50 kHz	6.30 kHz
		Q	1.4	10	1.2	0.28
06	Cymbal		L.SHELF	PEAKING	PEAKING	H.SHELF
		G	-2.0 dB	0.0 dB	0.0 dB	+3.0 dB
		F	106 Hz	425 Hz	1.06 kHz	13.2 kHz
		Q	—	8	0.9	—
07	High Hat		L.SHELF	PEAKING	PEAKING	H.SHELF
		G	-4.0 dB	-2.5 dB	+1.0 dB	+0.5 dB
		F	95 Hz	425 Hz	2.80 kHz	7.50 kHz
		Q	—	0.5	1	—
08	Percussion		L.SHELF	PEAKING	PEAKING	H.SHELF
		G	-4.5 dB	0.0 dB	+2.0 dB	0.0 dB
		F	100 Hz	400 Hz	2.80 kHz	17.0 kHz
		Q	—	4.5	0.56	—
09	E. Bass 1		L.SHELF	PEAKING	PEAKING	H.SHELF
		G	-7.5 dB	+4.5 dB	+2.5 dB	0.0 dB
		F	35.5 Hz	112 Hz	2.00 kHz	4.00 kHz
		Q	—	5	4.5	—
10	E. Bass 2		PEAKING	PEAKING	PEAKING	H.SHELF
		G	+3.0 dB	0.0 dB	+2.5 dB	+0.5 dB
		F	112 Hz	112 Hz	2.24 kHz	4.00 kHz
		Q	0.1	5	6.3	—
11	Syn. Bass 1		PEAKING	PEAKING	PEAKING	H.SHELF
		G	+3.5 dB	+8.5 dB	0.0 dB	0.0 dB
		F	85 Hz	950 Hz	4.00 kHz	12.5 kHz
		Q	0.1	8	4.5	—
12	Syn. Bass 2		PEAKING	PEAKING	PEAKING	H.SHELF
		G	+2.5 dB	0.0 dB	+1.5 dB	0.0 dB
		F	125 Hz	180 Hz	1.12 kHz	12.5 kHz
		Q	1.6	8	2.2	—
13	Piano 1		L.SHELF	PEAKING	PEAKING	H.SHELF
		G	-6.0 dB	0.0 dB	+2.0 dB	+4.0 dB
		F	95 Hz	950 Hz	3.15 kHz	7.50 kHz
		Q	—	8	0.9	—
14	Piano 2		PEAKING	PEAKING	PEAKING	H.SHELF
		G	+3.5 dB	-8.5 dB	+1.5 dB	+3.0 dB
		F	224 Hz	600 Hz	3.15 kHz	5.30 kHz
		Q	5.6	10	0.7	—

#	Title	Parameter				
		LOW	L-MID	H-MID	HIGH	
15	E. G. Clean		PEAKING	PEAKING	PEAKING	H.SHELF
		G	+2.0 dB	-5.5 dB	+0.5 dB	+2.5 dB
		F	265 Hz	400 Hz	1.32 kHz	4.50 kHz
		Q	0.18	10	6.3	—
16	E. G. Crunch 1		PEAKING	PEAKING	PEAKING	PEAKING
		G	+4.5 dB	0.0 dB	+4.0 dB	+2.0 dB
		F	140 Hz	1.00 kHz	1.90 kHz	5.60 kHz
		Q	8	4.5	0.63	9
17	E. G. Crunch 2		PEAKING	PEAKING	PEAKING	H.SHELF
		G	+2.5 dB	+1.5 dB	+2.5 dB	0.0 dB
		F	125 Hz	450 Hz	3.35 kHz	19.0 kHz
		Q	8	0.4	0.16	—
18	E. G. Dist. 1		L.SHELF	PEAKING	PEAKING	H.SHELF
		G	+5.0 dB	0.0 dB	+3.5 dB	0.0 dB
		F	355 Hz	950 Hz	3.35 kHz	12.5 kHz
		Q	—	9	10	—
19	E. G. Dist. 2		L.SHELF	PEAKING	PEAKING	H.SHELF
		G	+6.0 dB	-8.5 dB	+4.5 dB	+4.0 dB
		F	315 Hz	1.06 kHz	4.25 kHz	12.5 kHz
		Q	—	10	4	—
20	A. G. Stroke 1		PEAKING	PEAKING	PEAKING	H.SHELF
		G	-2.0 dB	0.0 dB	+1.0 dB	+4.0 dB
		F	106 Hz	1.00 kHz	1.90 kHz	5.30 kHz
		Q	0.9	4.5	3.5	—
21	A. G. Stroke 2		L.SHELF	PEAKING	PEAKING	H.SHELF
		G	-3.5 dB	-2.0 dB	0.0 dB	+2.0 dB
		F	300 Hz	750 Hz	2.00 kHz	3.55 kHz
		Q	—	9	4.5	—
22	A. G. Arpeg. 1		L.SHELF	PEAKING	PEAKING	PEAKING
		G	-0.5 dB	0.0 dB	0.0 dB	+2.0 dB
		F	224 Hz	1.00 kHz	4.00 kHz	6.70 kHz
		Q	—	4.5	4.5	0.12
23	A. G. Arpeg. 2		L.SHELF	PEAKING	PEAKING	H.SHELF
		G	0.0 dB	-5.5 dB	0.0 dB	+4.0 dB
		F	180 Hz	355 Hz	4.00 kHz	4.25 kHz
		Q	—	7	4.5	—
24	Brass Sec.		PEAKING	PEAKING	PEAKING	PEAKING
		G	-2.0 dB	-1.0 dB	+1.5 dB	+3.0 dB
		F	90 Hz	850 Hz	2.12 kHz	4.50 kHz
		Q	2.8	2	0.7	7
25	Male Vocal 1		PEAKING	PEAKING	PEAKING	PEAKING
		G	-0.5 dB	0.0 dB	+2.0 dB	+3.5 dB
		F	190 Hz	1.00 kHz	2.00 kHz	6.70 kHz
		Q	0.11	4.5	0.56	0.11
26	Male Vocal 2		PEAKING	PEAKING	PEAKING	H.SHELF
		G	+2.0 dB	-5.0 dB	-2.5 dB	+4.0 dB
		F	170 Hz	236 Hz	2.65 kHz	6.70 kHz
		Q	0.11	10	5.6	—
27	Female Vo. 1		PEAKING	PEAKING	PEAKING	PEAKING
		G	-1.0 dB	+1.0 dB	+1.5 dB	+2.0 dB
		F	118 Hz	400 Hz	2.65 kHz	6.00 kHz
		Q	0.18	0.45	0.56	0.14
28	Female Vo. 2		L.SHELF	PEAKING	PEAKING	H.SHELF
		G	-7.0 dB	+1.5 dB	+1.5 dB	+2.5 dB
		F	112 Hz	335 Hz	2.00 kHz	6.70 kHz
		Q	—	0.16	0.2	—

#	Title	Parameter				
		LOW	L-MID	H-MID	HIGH	
29	Chorus & Harmo		PEAKING	PEAKING	PEAKING	PEAKING
		G	-2.0 dB	-1.0 dB	+1.5 dB	+3.0 dB
		F	90 Hz	850 Hz	2.12 kHz	4.50 kHz
		Q	2.8	2	0.7	7
30	Total EQ 1		PEAKING	PEAKING	PEAKING	H.SHELF
		G	-0.5 dB	0.0 dB	+3.0 dB	+6.5 dB
		F	95 Hz	950 Hz	2.12 kHz	16.0 kHz
		Q	7	2.2	5.6	—
31	Total EQ 2		PEAKING	PEAKING	PEAKING	H.SHELF
		G	+4.0 dB	+1.5 dB	+2.0 dB	+6.0 dB
		F	95 Hz	750 Hz	1.80 kHz	18.0 kHz
		Q	7	2.8	5.6	—
32	Total EQ 3		L.SHELF	PEAKING	PEAKING	H.SHELF
		G	+1.5 dB	+0.5 dB	+2.0 dB	+4.0 dB
		F	67 Hz	850 Hz	1.90 kHz	15.0 kHz
		Q	—	0.28	0.7	—
33	Bass Drum 3		PEAKING	PEAKING	PEAKING	PEAKING
		G	+3.5 dB	-10.0 dB	+3.5 dB	0.0 dB
		F	118 Hz	315 Hz	4.25 kHz	20.0 kHz
		Q	2	10	0.4	0.4
34	Snare Drum 3		L.SHELF	PEAKING	PEAKING	PEAKING
		G	0.0 dB	+2.0 dB	+3.5 dB	0.0 dB
		F	224 Hz	560 Hz	4.25 kHz	4.00 kHz
		Q	—	4.5	2.8	0.1
35	Tom-tom 2		L.SHELF	PEAKING	PEAKING	H.SHELF
		G	-9.0 dB	+1.5 dB	+2.0 dB	0.0 dB
		F	90 Hz	212 Hz	5.30 kHz	17.0 kHz
		Q	—	4.5	1.2	—
36	Piano 3		PEAKING	PEAKING	PEAKING	H.SHELF
		G	+4.5 dB	-13.0 dB	+4.5 dB	+2.5 dB
		F	100 Hz	475 Hz	2.36 kHz	10.0 kHz
		Q	8	10	9	—
37	Piano Low		PEAKING	PEAKING	PEAKING	H.SHELF
		G	-5.5 dB	+1.5 dB	+6.0 dB	0.0 dB
		F	190 Hz	400 Hz	6.70 kHz	12.5 kHz
		Q	10	6.3	2.2	—
38	Piano High		PEAKING	PEAKING	PEAKING	PEAKING
		G	-5.5 dB	+1.5 dB	+5.0 dB	+3.0 dB
		F	190 Hz	400 Hz	6.70 kHz	5.60 kHz
		Q	10	6.3	2.2	0.1
39	Fine-EQ Cass		L.SHELF	PEAKING	PEAKING	H.SHELF
		G	-1.5 dB	0.0 dB	+1.0 dB	+3.0 dB
		F	75 Hz	1.00 kHz	4.00 kHz	12.5 kHz
		Q	—	4.5	1.8	—
40	Narrator		PEAKING	PEAKING	PEAKING	H.SHELF
		G	-4.0 dB	-1.0 dB	+2.0 dB	0.0 dB
		F	106 Hz	710 Hz	2.50 kHz	10.0 kHz
		Q	4	7	0.63	—

## Dynamics Parameters

Dynamics processors are generally used to correct or control signal levels. However, you can also use them creatively to shape the volume envelope of a sound. The AW2400 features comprehensive dynamics processors for all the input channels, tape returns, and the bus and stereo outputs. These processors allow you to compress, expand, compress-expand (compend), gate, or duck the signals passing through the mixer, giving you unparalleled sonic quality and flexibility.

### Compressor

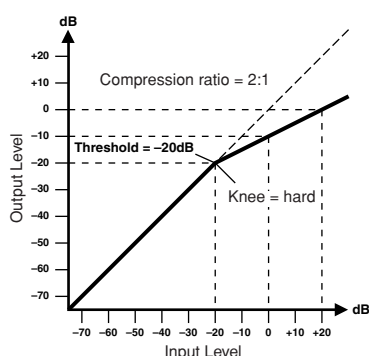

A compressor provides a form of automatic level control. By attenuating high levels, thus effectively reducing the dynamic range, the compressor makes it much easier to control signals and set appropriate fader levels. Reducing the dynamic range also means that recording levels can be set higher, therefore improving the signal-to-noise performance.

#### Compressor (CMP) parameters:

Parameter	Value
Threshold (dB)	-54 to 0 (541 points)
Ratio	1.0, 1.1, 1.3, 1.5, 1.7, 2.0, 2.5, 3.0, 3.5, 4.0, 5.0, 6.0, 8.0, 10, 20, ∞ (16 points)
Attack (ms)	0 to 120 (121 points)
Outgain (dB)	0 to +18 (181 points)
Knee	hard, 1, 2, 3, 4, 5 (6 points)
Release (ms)	6 ms to 46.1 sec (160 points)

• **Threshold** — determines the level of input signal required to trigger the compressor. Signals at a level below the threshold pass through unaffected. Signals at and above the threshold level are compressed by the amount specified using the Ratio parameter. The trigger signal is determined using the KEYIN SOURCE parameter.

• **Ratio** — controls the amount of compression—the change in output signal level relative to change in input signal level. With a 2:1 ratio, for example, a 10 dB change in input level (above the threshold) results in a 5 dB change in output level. For a 5:1 ratio, a 10 dB change in input level (above the threshold) results in a 2 dB change in output level.

• **Attack** — controls how soon the signal is compressed once the compressor has been triggered. With a fast attack time, the signal is compressed almost immediately. With a slow attack time, the initial transient of a sound passes through unaffected.

• **Out Gain** — sets the compressor's output signal level. Compression tends to reduce the average signal level. Out Gain can be used to counter this level reduction and set an appropriate level for the next stage in the audio path.

• **Knee** — sets the transition of the signal at the threshold. With a hard knee, the transition between uncompressed and compressed signal is immediate. With the softest knee, knee5, the transition starts before the signal reaches the threshold and gradually ends above the threshold.

• **Release** — determines how soon the compressor returns to its normal gain once the trigger signal level drops below the threshold. If the release time is too short, the gain will recover too quickly causing level pumping—noticeable gain fluctuations. If it is set too long, the compressor may not have time to recover before the next high level signal appears, and it will be compressed incorrectly.



## ■ Expander

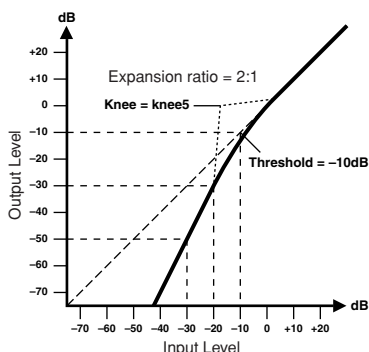

An expander is another form of automatic level control. By attenuating the signal below the threshold, the expander reduces low-level noise and effectively increases the dynamic range of the recorded material.

### Expander (EXP) parameters:

Parameter	Value
Threshold (dB)	-54 to 0 (541 points)
Ratio	1.0, 1.1, 1.3, 1.5, 1.7, 2.0, 2.5, 3.0, 3.5, 4.0, 5.0, 6.0, 8.0, 10, 20, ∞ (16 points)
Attack (ms)	0 to 120 (121 points)
Outgain (dB)	0 to +18 (181 points)
Knee	hard,1,2,3,4,5 (6 points)
Release (ms)	6 ms to 46.1 sec (160 points)

- **Threshold** — determines the level of input signal required to trigger the expander. Signals above the threshold pass through unaffected. Signals at and below the threshold level are attenuated by the amount specified using the Ratio parameter. The trigger signal is determined using the KEYIN SOURCE parameter.

- **Ratio** — controls the amount of expansion—the change in output signal level relative to change in input signal level. With a 1:2 ratio, for example, a 5 dB change in input level (below the threshold) results in a 10 dB change in output level. For a 1:5 ratio, a 2 dB change in input level (below the threshold) results in a 10 dB change in output level.

- **Attack** — controls how soon the signal is expanded once the expander has been triggered. With a fast attack time, the signal is expanded almost immediately. With a slow attack time, the initial transient of a sound passes through unaffected.

- **Out Gain** — sets the expander's output signal level.

- **Knee** — sets the transition of the signal at the threshold. With a hard knee, the transition between unexpanded and expanded signal is immediate. With the softest knee, knee5, the transition starts before the signal reaches the threshold and gradually ends above the threshold.

- **Release** — determines how soon the expander returns to its normal gain once the trigger signal level drops below the threshold.

## ■ Compander

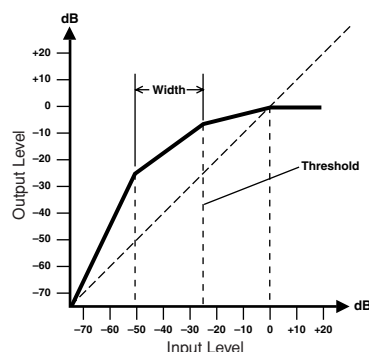

A compander is a compressor-expander—a combination of signal compression and expansion. The compander attenuates the input signal above the threshold as well as the level below the width. For very dynamic material, this program allows you to retain the dynamic range without having to be concerned with excessive output signal levels and clipping.

### CompanderH (CPH) and CompanderS (CPS) parameters:

Parameter	Value
Threshold (dB)	-54 to 0 (541 points)
Ratio	1.0, 1.1, 1.3, 1.5, 1.7, 2.0, 2.5, 3.0, 3.5, 4.0, 5.0, 6.0, 8.0, 10, 20 (15 points)
Attack (ms)	0 to 120 (121 points)
Outgain (dB)	-18 to 0 (181 points)
Width (dB)	1 to 90 (90 points)
Release (ms)	6 ms to 46.1 sec (160 points)

- **Threshold** — determines the level of input signal required to trigger the compander. Signals above the threshold pass through unaffected. Signals at and below the threshold level are attenuated by the amount specified using the Ratio parameter. The trigger signal is determined using the KEYIN SOURCE parameter.

- **Ratio** — controls the amount of companding—the change in output signal level relative to change in input signal level. With a 2:1 ratio, for example, a 10 dB change in input level (above the threshold) results in a 5 dB change in output level. The hard compander (CPH) has a fixed ratio of 5:1 for expansion and the soft compander (CPS) has a fixed ratio of 1.5:1 for expansion.

- **Attack** — controls how soon the signal is companded once the compander has been triggered. With a fast attack time, the signal is companded almost immediately. With a slow attack time, the initial transient of a sound passes through unaffected.

- **Out Gain** — sets the compander's output signal level.

- **Width** — is used to determine the distance, in decibels, between the expander and the compressor. With a width of 90 dB, the expander is effectively switched off and the compander is simply a compressor-limiter. With a smaller width (30 dB) and a high threshold (0 dB), the compander is an expander-compressor-limiter.

- **Release** — determines how soon the compander returns to its normal gain once the trigger signal level drops below the threshold.

## Gate and Ducking

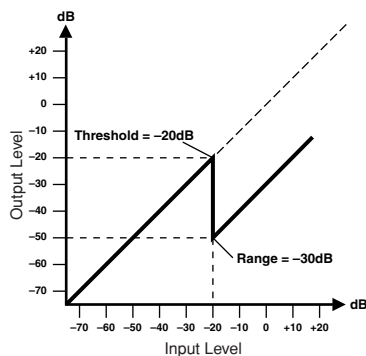
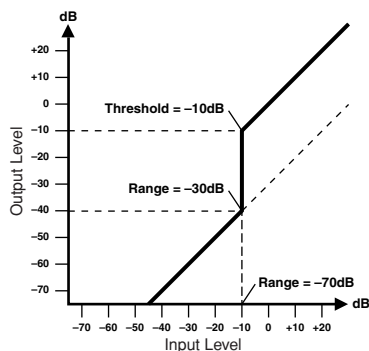

A gate, or noise gate is an audio switch used to mute signals below a set threshold level. It can be used to suppress background noise and hiss from valve (tube) amps, effects pedals, and microphones.

Ducking is used to automatically reduce the levels of one signal when the level of a source signal exceeds a specified threshold. It is used for voice-over applications where, for example, level of background music is automatically reduced, allowing an announcer to be heard clearly.

### Gate (GAT) and Ducking (DUK) parameters:

Parameter	Value
Threshold (dB)	-54 to 0 (541 points)
Range (dB)	-70 to 0 (701 points)
Attack (ms)	0 to 120 (121 points)
Hold (ms)	0.02 ms to 2.14 sec (216 points)
Decay (ms)	6 ms to 46.1 sec (160 points)

• **Threshold** — sets the level at which the gate closes, cutting off the signal. Signals above the threshold level pass through unaffected. Signals at or below the threshold cause the gate to close.

For ducking, trigger signal levels at and above the threshold level activate ducking, and the signal level is reduced to a level set by the Range parameter.

The trigger signal is determined using the KEYIN SOURCE parameter.

• **Range** — controls the level to which the gate closes. It can be used to reduce the signal level rather than cut it completely. At a setting of -70 dB, the gate closes completely when the input signal falls below the threshold. At a setting of -30 dB, the gate only closes so far allowing an attenuated signal through. At a setting of 0 dB, the gate has no effect. When signals are gated abruptly, the sudden cutoff can sound odd.

For ducking, a setting of -70 dB causes the signal to be virtually cutoff. At a setting of -30 dB the signal is ducked by 30 dB. At a setting of 0 dB, the duck has no effect.

• **Attack** — determines how fast the gate opens when the signal exceeds the threshold level. Slow attack times can be used to remove the initial transient edge of percussive sounds. Too slow an attack time makes some signals sound backwards.

For ducking, this controls how soon the signal is ducked once the duck has been triggered. With a fast attack time, the signal is ducked almost immediately. With a slow attack time, ducking fades the signal. Too fast an attack time may sound abrupt.

• **Hold** — sets how long the gate stays open or the ducking remains active once the trigger signal has fallen below the threshold level.

• **Decay** — controls how fast the gate closes once the hold time has expired. A longer decay time produces a more natural gating effect, allowing the natural decay of an instrument to pass through.

For ducking, this determines how soon the ducker returns to its normal gain after the hold time has expired.

## Gate Parameter list

(fs = 44.1 kHz)

#	Title	Type	Parameter	Value
1	Gate	GATE	Threshold (dB)	-26
			Range (dB)	-56
			Attack (ms)	0
			Hold (ms)	2.56
			Decay (ms)	331
2	Ducking	DUCKING	Threshold (dB)	-19
			Range (dB)	-22
			Attack (ms)	93
			Hold (ms)	1.20 S
			Decay (ms)	6.32 S

#	Title	Type	Parameter	Value
3	A. Dr. BD	GATE	Threshold (dB)	-11
			Range (dB)	-53
			Attack (ms)	0
			Hold (ms)	1.93
			Decay (ms)	400
4	A. Dr. SN	GATE	Threshold (dB)	-8
			Range (dB)	-23
			Attack (ms)	1
			Hold (ms)	0.63
			Decay (ms)	238

## Compressor Parameter list

(fs = 44.1 kHz)

#	Title	Type	Parameter	Value
1	Comp	COMP	Threshold (dB)	-8
			Ratio ( :1)	2.5
			Attack (ms)	60
			Out gain (dB)	0.0
			Knee	2
			Release (ms)	250
2	Expand	EXPAND	Threshold (dB)	-23
			Ratio ( :1)	1.7
			Attack (ms)	1
			Out gain (dB)	3.5
			Release (ms)	70
3	Compander (H)	COMPAND-H	Threshold (dB)	-10
			Ratio ( :1)	3.5
			Attack (ms)	1
			Out gain (dB)	0.0
			Width (dB)	6
			Release (ms)	250
4	Compander (S)	COMPAND-S	Threshold (dB)	-8
			Ratio ( :1)	4
			Attack (ms)	25
			Out gain (dB)	0.0
			Release (ms)	180
5	A. Dr. BD	COMP	Threshold (dB)	-24
			Ratio ( :1)	3
			Attack (ms)	9
			Out gain (dB)	5.5
			Release (ms)	58
6	A. Dr. BD	COMPAND-H	Threshold (dB)	-11
			Ratio ( :1)	3.5
			Attack (ms)	1
			Out gain (dB)	-1.5
			Width (dB)	7
			Release (ms)	192
7	A. Dr. SN	COMP	Threshold (dB)	-17
			Ratio ( :1)	2.5
			Attack (ms)	8
			Out gain (dB)	3.5
			Release (ms)	12

#	Title	Type	Parameter	Value
8	A. Dr. SN	EXPAND	Threshold (dB)	-23
			Ratio ( :1)	2
			Attack (ms)	0
			Out gain (dB)	0.5
			Knee	2
			Release (ms)	151
9	A. Dr. SN	COMPAND-S	Threshold (dB)	-8
			Ratio ( :1)	1.7
			Attack (ms)	11
			Out gain (dB)	0.0
			Width (dB)	10
			Release (ms)	128
10	A. Dr. Tom	EXPAND	Threshold (dB)	-20
			Ratio ( :1)	2
			Attack (ms)	2
			Out gain (dB)	5.0
			Knee	2
			Release (ms)	749
11	A. Dr. OverTop	COMPAND-S	Threshold (dB)	-24
			Ratio ( :1)	2
			Attack (ms)	38
			Out gain (dB)	-3.5
			Release (ms)	842
12	E. B. Finger	COMP	Threshold (dB)	-12
			Ratio ( :1)	2
			Attack (ms)	15
			Out gain (dB)	4.5
			Release (ms)	470
13	E. B. Slap	COMP	Threshold (dB)	-12
			Ratio ( :1)	1.7
			Attack (ms)	6
			Out gain (dB)	4.0
			Release (ms)	133
14	Syn. Bass	COMP	Threshold (dB)	-10
			Ratio ( :1)	3.5
			Attack (ms)	9
			Out gain (dB)	3.0
			Release (ms)	250

#	Title	Type	Parameter	Value	#	Title	Type	Parameter	Value
15	Piano1	COMP	Threshold (dB)	-9	26	Sampling SN	COMP	Threshold (dB)	-18
			Ratio ( :1)	2.5				Ratio ( :1)	4
			Attack (ms)	17				Attack (ms)	8
			Out gain (dB)	1.0				Out gain (dB)	8.0
			Knee	hard				Knee	hard
			Release (ms)	238				Release (ms)	354
16	Piano2	COMP	Threshold (dB)	-18	27	Hip Comp	COMPAND-S	Threshold (dB)	-23
			Ratio ( :1)	3.5				Ratio ( :1)	20
			Attack (ms)	7				Attack (ms)	15
			Out gain (dB)	6.0				Out gain (dB)	0.0
			Knee	2				Width (dB)	15
			Release (ms)	174				Release (ms)	163
17	E. Guitar	COMP	Threshold (dB)	-8	28	Solo Vocal1	COMP	Threshold (dB)	-20
			Ratio ( :1)	3.5				Ratio ( :1)	2.5
			Attack (ms)	7				Attack (ms)	31
			Out gain (dB)	2.5				Out gain (dB)	2.0
			Knee	4				Knee	1
			Release (ms)	261				Release (ms)	342
18	A. Guitar	COMP	Threshold (dB)	-10	29	Solo Vocal2	COMP	Threshold (dB)	-8
			Ratio ( :1)	2.5				Ratio ( :1)	2.5
			Attack (ms)	5				Attack (ms)	26
			Out gain (dB)	1.5				Out gain (dB)	1.5
			Knee	2				Knee	3
			Release (ms)	238				Release (ms)	331
19	Strings1	COMP	Threshold (dB)	-11	30	Chorus	COMP	Threshold (dB)	-9
			Ratio ( :1)	2				Ratio ( :1)	1.7
			Attack (ms)	33				Attack (ms)	39
			Out gain (dB)	1.5				Out gain (dB)	2.5
			Knee	2				Knee	2
			Release (ms)	749				Release (ms)	226
20	Strings2	COMP	Threshold (dB)	-12	31	Click Erase	EXPAND	Threshold (dB)	-33
			Ratio ( :1)	1.5				Ratio ( :1)	2
			Attack (ms)	93				Attack (ms)	1
			Out gain (dB)	1.5				Out gain (dB)	2.0
			Knee	4				Knee	2
			Release (ms)	1.35 S				Release (ms)	284
21	Strings3	COMP	Threshold (dB)	-17	32	Announcer	COMPAND-H	Threshold (dB)	-14
			Ratio ( :1)	1.5				Ratio ( :1)	2.5
			Attack (ms)	76				Attack (ms)	1
			Out gain (dB)	2.5				Out gain (dB)	-2.5
			Knee	2				Width (dB)	18
			Release (ms)	186				Release (ms)	180
22	BrassSection	COMP	Threshold (dB)	-18	33	Limiter1	COMPAND-S	Threshold (dB)	-9
			Ratio ( :1)	1.7				Ratio ( :1)	3
			Attack (ms)	18				Attack (ms)	20
			Out gain (dB)	4.0				Out gain (dB)	-3.0
			Knee	1				Width (dB)	90
			Release (ms)	226				Release (ms)	3.90 s
23	Syn. Pad	COMP	Threshold (dB)	-13	34	Limiter2	COMP	Threshold (dB)	0
			Ratio ( :1)	2				Ratio ( :1)	∞
			Attack (ms)	58				Attack (ms)	0
			Out gain (dB)	2.0				Out gain (dB)	0.0
			Knee	1				Knee	hard
			Release (ms)	238				Release (ms)	319
24	SamplingPerc	COMPAND-S	Threshold (dB)	-18	35	Total Comp1	COMP	Threshold (dB)	-18
			Ratio ( :1)	1.7				Ratio ( :1)	3.5
			Attack (ms)	8				Attack (ms)	94
			Out gain (dB)	-2.5				Out gain (dB)	2.5
			Width (dB)	18				Knee	hard
			Release (ms)	238				Release (ms)	447
25	Sampling BD	COMP	Threshold (dB)	-14	36	Total Comp2	COMP	Threshold (dB)	-16
			Ratio ( :1)	2				Ratio ( :1)	6
			Attack (ms)	2				Attack (ms)	11
			Out gain (dB)	3.5				Out gain (dB)	6.0
			Knee	4				Knee	1
			Release (ms)	35				Release (ms)	180

## Effects Parameters

### ■ REVERB HALL, REVERB ROOM, REVERB STAGE, REVERB PLATE

One input, two output hall, room, stage, and plate reverb simulations, all with gates.

Parameter	Range	Description
REV TIME	0.3–99.0 s	Reverb time
INI. DLY	0.0–500.0 ms	Initial delay before reverb begins
HI. RATIO	0.1–1.0	High-frequency reverb time ratio
LO. RATIO	0.1–2.4	Low-frequency reverb time ratio
DIFF.	0–10	Reverb diffusion (left–right reverb spread)
DENSITY	0–100%	Reverb density
E/R DLY	0.0–100.0 ms	Delay between early reflections and reverb
E/R BAL.	0–100%	Balance of early reflections and reverb (0% = all reverb, 100% = all early reflections)
HPF	THRU, 21.2 Hz–8.00 kHz	High-pass filter cutoff frequency
LPF	50.0 Hz–16.0 kHz, THRU	Low-pass filter cutoff frequency
GATE LVL	OFF, -60 to 0 dB	Level at which gate kicks in
ATTACK	0–120 ms	Gate opening speed
HOLD	*1	Gate open time
DECAY	*2	Gate closing speed

\*1. 0.02 ms–2.13 s (fs=44.1 kHz), 0.02 ms–1.96 s (fs=48 kHz)

\*2. 6 ms–46.0 s (fs=44.1 kHz), 5 ms–42.3 s (fs=48 kHz)

### ■ EARLY REF.

One input, two output early reflections.

Parameter	Range	Description
TYPE	S-Hall, L-Hall, Random, Revers, Plate, Spring	Type of early reflection simulation
ROOMSIZE	0.1–20.0	Reflection spacing
LIVENESS	0–10	Early reflections decay characteristics (0 = dead, 10 = live)
INI. DLY	0.0–500.0 ms	Initial delay before reverb begins
DIFF.	0–10	Reflection diffusion (left–right reflection spread)
DENSITY	0–100%	Reflection density
ER NUM.	1–19	Number of early reflections
FB.GAIN	-99 to +99%	Feedback gain
HI. RATIO	0.1–1.0	High-frequency feedback ratio
HPF	THRU, 21.2 Hz–8.00 kHz	High-pass filter cutoff frequency
LPF	50.0 Hz–16.0 kHz, THRU	Low-pass filter cutoff frequency

### ■ GATE REVERB, REVERSE GATE

One input, two output early reflections with gate, and early reflections with reverse gate.

Parameter	Range	Description
TYPE	Type-A, Type-B	Type of early reflection simulation
ROOMSIZE	0.1–20.0	Reflection spacing
LIVENESS	0–10	Early reflections decay characteristics (0 = dead, 10 = live)
INI. DLY	0.0–500.0 ms	Initial delay before reverb begins
DIFF.	0–10	Reflection diffusion (left–right reflection spread)
DENSITY	0–100%	Reflection density
HI. RATIO	0.1–1.0	High-frequency feedback ratio
ER NUM.	1–19	Number of early reflections
FB.GAIN	-99 to +99%	Feedback gain
HPF	THRU, 21.2 Hz–8.00 kHz	High-pass filter cutoff frequency
LPF	50.0 Hz–16.0 kHz, THRU	Low-pass filter cutoff frequency

### ■ MONO DELAY

One input, two output basic repeat delay.

Parameter	Range	Description
DELAY	0.0–2730.0 ms	Delay time
FB. GAIN	-99 to +99%	Feedback gain (plus values for normal-phase feedback, minus values for reverse-phase feedback)
HI. RATIO	0.1–1.0	High-frequency feedback ratio
HPF	THRU, 21.2 Hz–8.00 kHz	High-pass filter cutoff frequency
LPF	50.0 Hz–16.0 kHz, THRU	Low-pass filter cutoff frequency

### ■ STEREO DELAY

Two input, two output basic stereo delay.

Parameter	Range	Description
DELAY L	0.0–1350.0 ms	Left channel delay time
DELAY R	0.0–1350.0 ms	Right channel delay time
FB. G L	-99 to +99%	Left channel feedback (plus values for normal-phase feedback, minus values for reverse-phase feedback)
FB. G R	-99 to +99%	Right channel feedback (plus values for normal-phase feedback, minus values for reverse-phase feedback)
HI. RATIO	0.1–1.0	High-frequency feedback ratio
HPF	THRU, 21.2 Hz–8.00 kHz	High-pass filter cutoff frequency
LPF	50.0 Hz–16.0 kHz, THRU	Low-pass filter cutoff frequency

### ■ MOD. DELAY

One input, two output basic repeat delay with modulation.

Parameter	Range	Description
DELAY	0.0–2725.0 ms	Delay time
FB. GAIN	-99 to +99%	Feedback gain (plus values for normal-phase feedback, minus values for reverse-phase feedback)
HI. RATIO	0.1–1.0	High-frequency feedback ratio
FREQ.	0.05–40.00 Hz	Modulation speed
DEPTH	0–100%	Modulation depth
WAVE	Sine, Tri	Modulation waveform
HPF	THRU, 21.2 Hz–8.00 kHz	High-pass filter cutoff frequency
LPF	50.0 Hz–16.0 kHz, THRU	Low-pass filter cutoff frequency
SYNC	OFF, ON	Tempo parameter sync on/off

### ■ DELAY LCR

One input, two output 3-tap delay (left, center, right).

Parameter	Range	Description
DELAY L	0.0–2730.0 ms	Left channel delay time
DELAY C	0.0–2730.0 ms	Center channel delay time
DELAY R	0.0–2730.0 ms	Right channel delay time
FB. DLY	0.0–2730.0 ms	Feedback delay time
LEVEL L	-100 to +100%	Left channel delay level
LEVEL C	-100 to +100%	Center channel delay level
LEVEL R	-100 to +100%	Right channel delay level
FB. GAIN	-99 to +99%	Feedback gain (plus values for normal-phase feedback, minus values for reverse-phase feedback)
HI. RATIO	0.1–1.0	High-frequency feedback ratio
HPF	THRU, 21.2 Hz–8.00 kHz	High-pass filter cutoff frequency
LPF	50.0 Hz–16.0 kHz, THRU	Low-pass filter cutoff frequency

## ■ ECHO

Two input, two output stereo delay with crossed feedback loop.

Parameter	Range	Description
DELAY L	0.0–1350.0 ms	Left channel delay time
DELAY R	0.0–1350.0 ms	Right channel delay time
FB.DLY L	0.0–1350.0 ms	Left channel feedback delay time
FB.DLY R	0.0–1350.0 ms	Right channel feedback delay time
FB. G L	-99 to +99%	Left channel feedback gain (plus values for normal-phase feedback, minus values for reverse-phase feedback)
FB. G R	-99 to +99%	Right channel feedback gain (plus values for normal-phase feedback, minus values for reverse-phase feedback)
L->R FBG	-99 to +99%	Left to right channel feedback gain (plus values for normal-phase feedback, minus values for reverse-phase feedback)
R->L FBG	-99 to +99%	Right to left channel feedback gain (plus values for normal-phase feedback, minus values for reverse-phase feedback)
HI. RATIO	0.1–1.0	High-frequency feedback ratio
HPF	THRU, 21.2 Hz–8.00 kHz	High-pass filter cutoff frequency
LPF	50.0 Hz–16.0 kHz, THRU	Low-pass filter cutoff frequency

## ■ CHORUS

Two input, two output chorus effect.

Parameter	Range	Description
FREQ.	0.05–40.00 Hz	Modulation speed
AM DEPTH	0–100%	Amplitude modulation depth
PM DEPTH	0–100%	Pitch modulation depth
MOD. DLY	0.0–500.0 ms	Modulation delay time
WAVE	Sine, Tri	Modulation waveform
LSH F	21.2 Hz–8.00 kHz	Low shelving filter frequency
LSH G	-12.0 to +12.0 dB	Low shelving filter gain
EQ F	100 Hz–8.00 kHz	EQ (peaking type) frequency
EQ G	-12.0 to +12.0 dB	EQ (peaking type) gain
EQ Q	10.0–0.10	EQ (peaking type) bandwidth
HSH F	50.0 Hz–16.0 kHz	High shelving filter frequency
HSH G	-12.0 to +12.0 dB	High shelving filter gain

## ■ FLANGE

Two input, two output flange effect.

Parameter	Range	Description
FREQ.	0.05–40.00 Hz	Modulation speed
DEPTH	0–100%	Modulation depth
MOD. DLY	0.0–500.0 ms	Modulation delay time
FB. GAIN	-99 to +99%	Feedback gain (plus values for normal-phase feedback, minus values for reverse-phase feedback)
WAVE	Sine, Tri	Modulation waveform
LSH F	21.2 Hz–8.00 kHz	Low shelving filter frequency
LSH G	-12.0 to +12.0 dB	Low shelving filter gain
EQ F	100 Hz–8.00 kHz	EQ (peaking type) frequency
EQ G	-12.0 to +12.0 dB	EQ (peaking type) gain
EQ Q	10.0–0.10	EQ (peaking type) bandwidth
HSH F	50.0 Hz–16.0 kHz	High shelving filter frequency
HSH G	-12.0 to +12.0 dB	High shelving filter gain

## ■ SYMPHONIC

Two input, two output symphonic effect.

Parameter	Range	Description
FREQ.	0.05–40.00 Hz	Modulation speed
DEPTH	0–100%	Modulation depth
MOD. DLY	0.0–500.0 ms	Modulation delay time
WAVE	Sine, Tri	Modulation waveform
LSH F	21.2 Hz–8.00 kHz	Low shelving filter frequency
LSH G	-12.0 to +12.0 dB	Low shelving filter gain
EQ F	100 Hz–8.00 kHz	EQ (peaking type) frequency
EQ G	-12.0 to +12.0 dB	EQ (peaking type) gain
EQ Q	10.0–0.10	EQ (peaking type) bandwidth
HSH F	50.0 Hz–16.0 kHz	High shelving filter frequency
HSH G	-12.0 to +12.0 dB	High shelving filter gain

## ■ PHASER

Two input, two output 16-stage phaser.

Parameter	Range	Description
FREQ.	0.05–40.00 Hz	Modulation speed
DEPTH	0–100%	Modulation depth
FB. GAIN	-99 to +99%	Feedback gain (plus values for normal-phase feedback, minus values for reverse-phase feedback)
OFFSET	0–100	Lowest phase-shifted frequency offset
PHASE	0.00–354.38 degrees	Left and right modulation phase balance
STAGE	2, 4, 6, 8, 10, 12, 14, 16	Number of phase shift stages
LSH F	21.2 Hz–8.00 kHz	Low shelving filter frequency
LSH G	-12.0 to +12.0 dB	Low shelving filter gain
HSH F	50.0 Hz–16.0 kHz	High shelving filter frequency
HSH G	-12.0 to +12.0 dB	High shelving filter gain

## ■ AUTO PAN

Two input, two output autopanner.

Parameter	Range	Description
FREQ.	0.05–40.00 Hz	Modulation speed
DEPTH	0–100%	Modulation depth
DIR.	*1	Panning direction
WAVE	Sine, Tri, Square	Modulation waveform
LSH F	21.2 Hz–8.00 kHz	Low shelving filter frequency
LSH G	-12.0 to +12.0 dB	Low shelving filter gain
EQ F	100 Hz–8.00 kHz	EQ (peaking type) frequency
EQ G	-12.0 to +12.0 dB	EQ (peaking type) gain
EQ Q	10.0–0.10	EQ (peaking type) bandwidth
HSH F	50.0 Hz–16.0 kHz	High shelving filter frequency
HSH G	-12.0 to +12.0 dB	High shelving filter gain

\*1. L->R, L->>R, L<->R, Turn L, Turn R



## ■ TREMOLO

Two input, two output tremolo effect.

Parameter	Range	Description
FREQ.	0.05–40.00 Hz	Modulation speed
DEPTH	0–100%	Modulation depth
WAVE	Sine, Tri, Square	Modulation waveform
LSH F	21.2 Hz–8.00 kHz	Low shelving filter frequency
LSH G	-12.0 to +12.0 dB	Low shelving filter gain
EQ F	100 Hz–8.00 kHz	EQ (peaking type) frequency
EQ G	-12.0 to +12.0 dB	EQ (peaking type) gain
EQ Q	10.0–0.10	EQ (peaking type) bandwidth
HSH F	50.0 Hz–16.0 kHz	High shelving filter frequency
HSH G	-12.0 to +12.0 dB	High shelving filter gain

## ■ HQ. PITCH

One input, two output high-quality pitch shifter (Available for internal effects 1 and 2.).

Parameter	Range	Description
PITCH	-12 to +12 semitones	Pitch shift
FINE	-50 to +50 cents	Pitch shift fine
DELAY	0.0–1000.0 ms	Delay time
FB. GAIN	-99 to +99%	Feedback gain (plus values for normal-phase feedback, minus values for reverse-phase feedback)
MODE	1–10	Pitch shift precision

## ■ DUAL PITCH

Two input, two output pitch shifter.

Parameter	Range	Description
PITCH 1	-24 to +24 semitones	Channel #1 pitch shift
FINE 1	-50 to +50 cents	Channel #1 pitch shift fine
LEVEL 1	-100 to +100%	Channel #1 level (plus values for normal phase, minus values for reverse phase)
PAN 1	L63 to R63	Channel #1 pan
DELAY 1	0.0–1000.0 ms	Channel #1 delay time
FB. G 1	-99 to +99%	Channel #1 feedback gain (plus values for normal-phase feedback, minus values for reverse-phase feedback)
PITCH 2	-24 to +24 semitones	Channel #2 pitch shift
FINE 2	-50 to +50 cents	Channel #2 pitch shift fine
LEVEL 2	-100 to +100%	Channel #2 level (plus values for normal phase, minus values for reverse phase)
PAN 2	L63 to R63	Channel #2 pan
DELAY 2	0.0–1000.0 ms	Channel #2 delay time
FB. G 2	-99 to +99%	Channel #2 feedback gain (plus values for normal-phase feedback, minus values for reverse-phase feedback)
MODE	1–10	Pitch shift precision

## ■ ROTARY

One input, two output rotary speaker simulator.

Parameter	Range	Description
ROTATE	STOP, START	Rotation stop, start
SPEED	SLOW, FAST	Rotation speed (see SLOW and FAST parameters)
SLOW	0.05–10.00 Hz	SLOW rotation speed
FAST	0.05–10.00 Hz	FAST rotation speed
DRIVE	0–100	Overdrive level
ACCEL	0–10	Acceleration at speed changes
LOW	0–100	Low-frequency filter
HIGH	0–100	High-frequency filter

### ■ RING MOD.

Two input, two output ring modulator.

Parameter	Range	Description
SOURCE	OSC, SELF	Modulation source: oscillator or input signal
OSC FREQ	0.0–5000.0 Hz	Oscillator frequency
FM FREQ.	0.05–40.00 Hz	Oscillator frequency modulation speed
FM DEPTH	0–100%	Oscillator frequency modulation depth

### ■ MOD. FILTER

Two input, two output modulation filter.

Parameter	Range	Description
FREQ.	0.05–40.00 Hz	Modulation speed
DEPTH	0–100%	Modulation depth
PHASE	0.00–354.38 degrees	Left-channel modulation and right-channel modulation phase difference
TYPE	LPF, HPF, BPF	Filter type: low pass, high pass, band pass
OFFSET	0–100	Filter frequency offset
RESO.	0–20	Filter resonance
LEVEL	0–100	Output level

### ■ DISTORTION

One input, two output distortion effect.

Parameter	Range	Description
DST TYPE	DST1, DST2, OVD1, OVD2, CRUNCH	Distortion type (DST = distortion, OVD = overdrive)
DRIVE	0–100	Distortion drive
MASTER	0–100	Master volume
TONE	-10 to +10	Tone
N. GATE	0–20	Noise reduction

### ■ AMP SIMULATE

One input, two output guitar amp simulator.

Parameter	Range	Description
AMP TYPE	*1	Guitar amp simulation type
DST TYPE	DST1, DST2, OVD1, OVD2, CRUNCH	Distortion type (DST = distortion, OVD = overdrive)
DRIVE	0–100	Distortion drive
MASTER	0–100	Master volume
BASS	0–100	Bass tone control
MIDDLE	0–100	Middle tone control
TREBLE	0–100	High tone control
CAB DEP	0–100%	Speaker cabinet simulation depth
EQ F	100–8.00 kHz	Parametric equalizer frequency
EQ G	-12.0 to +12.0 dB	Parametric equalizer gain
EQ Q	10.0–0.10	Parametric equalizer bandwidth
N. GATE	0–20	Noise reduction

\*1. STK-M1, STK-M2, THRASH, MIDBST, CMB-PG, CMB-VR, CMB-DX, CMB-TW, MINI, FLAT

### ■ DYNA. FILTER

Two input, two output dynamically controlled filter.

Parameter	Range	Description
SOURCE	INPUT, MIDI	Control source: input signal or MIDI Note On velocity
SENSE	0–100	Sensitivity
DIR.	UP, DOWN	Upward or downward frequency change
DECAY	*1	Filter frequency change decay speed
TYPE	LPF, HPF, BPF	Filter type
OFFSET	0–100	Filter frequency offset
RESO.	0–20	Filter resonance
LEVEL	0–100	Output Level

\*1. 6 ms–46.0 s (fs=44.1 kHz), 5 ms–42.3 s (fs=48 kHz)

### ■ DYNA. FLANGE

Two input, two output dynamically controlled flanger.

Parameter	Range	Description
SOURCE	INPUT, MIDI	Control source: input signal or MIDI Note On velocity
SENSE	0–100	Sensitivity
DIR.	UP, DOWN	Upward or downward frequency change
DECAY	*1	Decay speed
OFFSET	0–100	Delay time offset
FB.GAIN	-99 to +99%	Feedback gain (plus values for normal-phase feedback, minus values for reverse-phase feedback)
LSH F	21.2 Hz–8.00 kHz	Low shelving filter frequency
LSH G	-12.0 to +12.0 dB	Low shelving filter gain
EQ F	100 Hz–8.00 kHz	EQ (peaking type) frequency
EQ G	-12.0 to +12.0 dB	EQ (peaking type) gain
EQ Q	10.0–0.10	EQ (peaking type) bandwidth
HSH F	50.0 Hz–16.0 kHz	High shelving filter frequency
HSH G	-12.0 to +12.0 dB	High shelving filter gain

\*1. 6 ms–46.0 s (fs=44.1 kHz), 5 ms–42.3 s (fs=48 kHz)

### ■ DYNA. PHASER

Two input, two output dynamically controlled phaser.

Parameter	Range	Description
SOURCE	INPUT, MIDI	Control source: input signal or MIDI Note On velocity
SENSE	0–100	Sensitivity
DIR.	UP, DOWN	Upward or downward frequency change
DECAY	*1	Decay speed
OFFSET	0–100	Lowest phase-shifted frequency offset
FB.GAIN	-99 to +99%	Feedback gain (plus values for normal-phase feedback, minus values for reverse-phase feedback)
STAGE	2, 4, 6, 8, 10, 12, 14, 16	Number of phase shift stages
LSH F	21.2 Hz–8.00 kHz	Low shelving filter frequency
LSH G	-12.0 to +12.0 dB	Low shelving filter gain
HSH F	50.0 Hz–16.0 kHz	High shelving filter frequency
HSH G	-12.0 to +12.0 dB	High shelving filter gain

\*1. 6 ms–46.0 s (fs=44.1 kHz), 5 ms–42.3 s (fs=48 kHz)

### ■ REV+CHORUS

One input, two output reverb and chorus effects in parallel.

Parameter	Range	Description
REV TIME	0.3–99.0 s	Reverb time
INI. DLY	0.0–500.0 ms	Initial delay before reverb begins
HI. RATIO	0.1–1.0	High-frequency reverb time ratio
DIFF.	0–10	Spread
DENSITY	0–100%	Reverb density
HPF	THRU, 21.2 Hz–8.00 kHz	High-pass filter cutoff frequency
LPF	50.0 Hz–16.0 kHz, THRU	Low-pass filter cutoff frequency
REV/CHO	0–100%	Reverb and chorus balance (0% = all reverb, 100% = all chorus)
FREQ.	0.05–40.00 Hz	Modulation speed
AM DEPTH	0–100%	Amplitude modulation depth
PM DEPTH	0–100%	Pitch modulation depth
MOD. DLY	0.0–500.0 ms	Modulation delay time
WAVE	Sine, Tri	Modulation waveform

### ■ REV->CHORUS

One input, two output reverb and chorus effects in series.

Parameter	Range	Description
REV TIME	0.3–99.0 s	Reverb time
INI. DLY	0.0–500.0 ms	Initial delay before reverb begins
HI. RATIO	0.1–1.0	High-frequency reverb time ratio
DIFF.	0–10	Spread
DENSITY	0–100%	Reverb density
HPF	THRU, 21.2 Hz–8.00 kHz	High-pass filter cutoff frequency
LPF	50.0 Hz–16.0 kHz, THRU	Low-pass filter cutoff frequency
REV.BAL	0–100%	Reverb and chorused reverb balance (0% = all chorused reverb, 100% = all reverb)
FREQ.	0.05–40.00 Hz	Modulation speed
AM DEPTH	0–100%	Amplitude modulation depth
PM DEPTH	0–100%	Pitch modulation depth
MOD. DLY	0.0–500.0 ms	Modulation delay time
WAVE	Sine, Tri	Modulation waveform

### ■ REV+FLANGE

One input, two output reverb and flanger effects in parallel.

Parameter	Range	Description
REV TIME	0.3–99.0 s	Reverb time
INI. DLY	0.0–500.0 ms	Initial delay before reverb begins
HI. RATIO	0.1–1.0	High-frequency reverb time ratio
DIFF.	0–10	Spread
DENSITY	0–100%	Reverb density
HPF	THRU, 21.2 Hz–8.00 kHz	High-pass filter cutoff frequency
LPF	50.0 Hz–16.0 kHz, THRU	Low-pass filter cutoff frequency
REV/FLG	0–100%	Reverb and flange balance (0% = all reverb, 100% = all flange)
FREQ.	0.05–40.00 Hz	Modulation speed
DEPTH	0–100%	Modulation depth
MOD. DLY	0.0–500.0 ms	Modulation delay time
FB. GAIN	-99 to +99%	Feedback gain (plus values for normal-phase feedback, minus values for reverse-phase feedback)
WAVE	Sine, Tri	Modulation waveform

### ■ REV->FLANGE

One input, two output reverb and flanger effects in series.

Parameter	Range	Description
REV TIME	0.3–99.0 s	Reverb time
INI. DLY	0.0–500.0 ms	Initial delay before reverb begins
HI. RATIO	0.1–1.0	High-frequency reverb time ratio
DIFF.	0–10	Spread
DENSITY	0–100%	Reverb density
HPF	THRU, 21.2 Hz–8.00 kHz	High-pass filter cutoff frequency
LPF	50.0 Hz–16.0 kHz, THRU	Low-pass filter cutoff frequency
REV.BAL	0–100%	Reverb and flanged reverb balance (0% = all flanged reverb, 100% = all reverb)
FREQ.	0.05–40.00 Hz	Modulation speed
DEPTH	0–100%	Modulation depth
MOD. DLY	0.0–500.0 ms	Modulation delay time
FB. GAIN	-99 to +99%	Feedback gain (plus values for normal-phase feedback, minus values for reverse-phase feedback)
WAVE	Sine, Tri	Modulation waveform

### ■ REV+SYMPHO.

One input, two output reverb and symphonic effects in parallel.

Parameter	Range	Description
REV TIME	0.3–99.0 s	Reverb time
INI. DLY	0.0–500.0 ms	Initial delay before reverb begins
HI. RATIO	0.1–1.0	High-frequency reverb time ratio
DIFF.	0–10	Spread
DENSITY	0–100%	Reverb density
HPF	THRU, 21.2 Hz–8.00 kHz	High-pass filter cutoff frequency
LPF	50.0 Hz–16.0 kHz, THRU	Low-pass filter cutoff frequency
REV/SYM	0–100%	Reverb and symphonic balance (0% = all reverb, 100% = all symphonic)
FREQ.	0.05–40.00 Hz	Modulation speed
DEPTH	0–100%	Modulation depth
MOD. DLY	0.0–500.0 ms	Modulation delay time
WAVE	Sine, Tri	Modulation waveform

### ■ REV->SYMPHO.

One input, two output reverb and symphonic effects in series.

Parameter	Range	Description
REV TIME	0.3–99.0 s	Reverb time
INI. DLY	0.0–500.0 ms	Initial delay before reverb begins
HI. RATIO	0.1–1.0	High-frequency reverb time ratio
DIFF.	0–10	Spread
DENSITY	0–100%	Reverb density
HPF	THRU, 21.2 Hz–8.00 kHz	High-pass filter cutoff frequency
LPF	50.0 Hz–16.0 kHz, THRU	Low-pass filter cutoff frequency
REV.BAL	0–100%	Reverb and symphonic reverb balance (0% = all symphonic reverb, 100% = all reverb)
FREQ.	0.05–40.00 Hz	Modulation speed
DEPTH	0–100%	Modulation depth
MOD. DLY	0.0–500.0 ms	Modulation delay time
WAVE	Sine, Tri	Modulation waveform

### ■ REV->PAN

One input, two output reverb and autopan effects in parallel.

Parameter	Range	Description
REV TIME	0.3–99.0 s	Reverb time
INI. DLY	0.0–500.0 ms	Initial delay before reverb begins
HI. RATIO	0.1–1.0	High-frequency reverb time ratio
DIFF.	0–10	Spread
DENSITY	0–100%	Reverb density
HPF	THRU, 21.2 Hz–8.00 kHz	High-pass filter cutoff frequency
LPF	50.0 Hz–16.0 kHz, THRU	Low-pass filter cutoff frequency
REV.BAL	0–100%	Reverb and panned reverb balance (0% = all panned reverb, 100% = all reverb)
FREQ.	0.05–40.00 Hz	Modulation speed
DEPTH	0–100%	Modulation depth
DIR.	*1	Panning direction
WAVE	Sine, Tri, Square	Modulation waveform

\*1. L<->R, L->R, L<-R, Turn L, Turn R

### ■ DELAY+ER.

One input, two output delay and early reflections effects in parallel.

Parameter	Range	Description
DELAY L	0.0–1000.0 ms	Left channel delay time
DELAY R	0.0–1000.0 ms	Right channel delay time
FB. DLY	0.0–1000.0 ms	Feedback delay time
FB. GAIN	-99 to +99%	Feedback gain (plus values for normal-phase feedback, minus values for reverse-phase feedback)
HI. RATIO	0.1–1.0	High-frequency feedback ratio
HPF	THRU, 21.2 Hz–8.00 kHz	High-pass filter cutoff frequency
LPF	50.0 Hz–16.0 kHz, THRU	Low-pass filter cutoff frequency
DLY/ER	0–100%	Delay and early reflections balance (0% = all delay, 100% = all early reflections)
TYPE	S-Hall, L-Hall, Random, Revers, Plate, Spring	Type of early reflection simulation
ROOMSIZE	0.1–20.0	Reflection spacing
LIVENESS	0–10	Early reflections decay characteristics (0 = dead, 10 = live)
INI. DLY	0.0–500.0 ms	Initial delay before reverb begins
DIFF.	0–10	Spread
DENSITY	0–100%	Reverb density
ER NUM.	1–19	Number of early reflections

### ■ DELAY->ER.

One input, two output delay and early reflections effects in series.

Parameter	Range	Description
DELAY L	0.0–1000.0 ms	Left channel delay time
DELAY R	0.0–1000.0 ms	Right channel delay time
FB. DLY	0.0–1000.0 ms	Feedback delay time
FB. GAIN	-99 to +99%	Feedback gain (plus values for normal-phase feedback, minus values for reverse-phase feedback)
HI. RATIO	0.1–1.0	High-frequency feedback ratio
HPF	THRU, 21.2 Hz–8.00 kHz	High-pass filter cutoff frequency
LPF	50.0 Hz–16.0 kHz, THRU	Low-pass filter cutoff frequency
DLY.BAL	0–100%	Delay and early reflected delay balance (0% = all early reflected delay, 100% = all delay)
TYPE	S-Hall, L-Hall, Random, Revers, Plate, Spring	Type of early reflection simulation
ROOMSIZE	0.1–20.0	Reflection spacing
LIVENESS	0–10	Early reflections decay characteristics (0 = dead, 10 = live)
INI. DLY	0.0–500.0 ms	Initial delay before reverb begins
DIFF.	0–10	Spread
DENSITY	0–100%	Reverb density
ER NUM.	1–19	Number of early reflections

### ■ DELAY+REV

One input, two output delay and reverb effects in parallel.

Parameter	Range	Description
DELAY L	0.0–1000.0 ms	Left channel delay time
DELAY R	0.0–1000.0 ms	Right channel delay time
FB. DLY	0.0–1000.0 ms	Feedback delay time
FB. GAIN	-99 to +99%	Feedback gain (plus values for normal-phase feedback, minus values for reverse-phase feedback)
DELAY HI	0.1–1.0	Delay high-frequency feedback ratio
HPF	THRU, 21.2 Hz–8.00 kHz	High-pass filter cutoff frequency
LPF	50.0 Hz–16.0 kHz, THRU	Low-pass filter cutoff frequency
DLY.BAL	0–100%	Delay and reverb balance (0% = all delay, 100% = all reverb)
REV TIME	0.3–99.0 s	Reverb time
INI. DLY	0.0–500.0 ms	Initial delay before reverb begins
REV HI	0.1–1.0	High-frequency reverb time ratio
DIFF.	0–10	Spread
DENSITY	0–100%	Reverb density

### ■ DELAY->REV

One input, two output delay and reverb effects in series.

Parameter	Range	Description
DELAY L	0.0–1000.0 ms	Left channel delay time
DELAY R	0.0–1000.0 ms	Right channel delay time
FB. DLY	0.0–1000.0 ms	Feedback delay time
FB. GAIN	-99 to +99%	Feedback gain (plus values for normal-phase feedback, minus values for reverse-phase feedback)
DELAY HI	0.1–1.0	Delay high-frequency feedback ratio
HPF	THRU, 21.2 Hz–8.00 kHz	High-pass filter cutoff frequency
LPF	50.0 Hz–16.0 kHz, THRU	Low-pass filter cutoff frequency
DLY.BAL	0–100%	Delay and delayed reverb balance (0% = all delayed reverb, 100% = all delay)
REV TIME	0.3–99.0 s	Reverb time
INI. DLY	0.0–500.0 ms	Initial delay before reverb begins
REV HI	0.1–1.0	High-frequency reverb time ratio
DIFF.	0–10	Spread
DENSITY	0–100%	Reverb density

### ■ DIST->DELAY

One input, two output distortion and delay effects in series.

Parameter	Range	Description
DST TYPE	DST1, DST2, OVD1, OVD2, CRUNCH	Distortion type (DST = distortion, OVD = overdrive)
DRIVE	0–100	Distortion drive
MASTER	0–100	Master volume
TONE	-10 to +10	Tone control
N. GATE	0–20	Noise reduction
DELAY	0.0–2725.0 ms	Delay time
FB. GAIN	-99 to +99%	Feedback gain (plus values for normal-phase feedback, minus values for reverse-phase feedback)
HI. RATIO	0.1–1.0	High-frequency feedback ratio
FREQ.	0.05–40.00 Hz	Modulation speed
DEPTH	0–100%	Modulation depth
DLY.BAL	0–100%	Distortion and delay balance (0% = all distortion, 100% = all delayed distortion)

### ■ MULTI FILTER

Two input, two output 3-band multi-filter (24 dB/octave).

Parameter	Range	Description
TYPE 1	HPF, LPF, BPF	Filter 1 type: high pass, low pass, band pass
TYPE 2	HPF, LPF, BPF	Filter 2 type: high pass, low pass, band pass
TYPE 3	HPF, LPF, BPF	Filter 3 type: high pass, low pass, band pass
FREQ. 1	28.0 Hz–16.0 kHz	Filter 1 frequency
FREQ. 2	28.0 Hz–16.0 kHz	Filter 2 frequency
FREQ. 3	28.0 Hz–16.0 kHz	Filter 3 frequency
LEVEL 1	0–100	Filter 1 level
LEVEL 2	0–100	Filter 2 level
LEVEL 3	0–100	Filter 3 level
RESO. 1	0–20	Filter 1 resonance
RESO. 2	0–20	Filter 2 resonance
RESO. 3	0–20	Filter 3 resonance



## ■ GATE

This is a 2-in/2-out gate that attenuates signals below the specified threshold level.

Parameter	Range	Description
GATE ON	ON, OFF	Turns the gate function on or off.
THRESH	-54 to 0 dB	Sets the threshold level at which the gate begins to affect the input signal.
RANGE	-70 to 0 dB	Sets the level when the gate is closed.
ATTACK	0–120 ms	Sets the time it take for the gate to actually open after the threshold level is exceeded.
DECAY	*1	Sets the time it takes for the gate to close completely after it begins closing.
HOLD	*2	Sets the time it takes for the gate to begin closing after the signal drops below the threshold level.

\*1. 6–46.0 s (fs=44.1kHz), 5–42.3 s (fs=48kHz)

\*2. 0.02–2.13 s (fs=44.1kHz), 0.02–1.96 s (fs=48kHz)

## ■ M.BAND DYNA.

Two input, two output 3-band dynamics processor, with individual solo and gain reduction metering for each band.

Parameter	Range	Description
LOW GAIN	-96.0 to +12.0 dB	Low band level
MID GAIN	-96.0 to +12.0 dB	Mid band level
HI. GAIN	-96.0 to +12.0 dB	High band level
PRESENCE	-10 to +10	For positive values, the threshold of the high band is lowered and the threshold of the low band is increased. For negative values, the opposite will occur. When set to 0, all three bands are affected the same.
CMP. THRE	24.0 to 0.0 dB	Compressor threshold
CMP. RAT	1:1 to 20:1	Compressor ratio
CMP. ATK	0–120 ms	Compressor attack
CMP. REL	*1	Compressor release time
CMP. KNEE	0–5	Compressor knee
LOOKUP	0.0–100.0 ms	Lookup delay
CMP. BYP	OFF, ON	Compressor bypass
L–M XOVR	21.2 Hz–8.00 kHz	Low/mid crossover frequency
M–H XOVR	21.2 Hz–8.00 kHz	Mid/high crossover frequency
SLOPE	-6 to -12 dB	Filter slope
CEILING	-6.0 to 0.0 dB, OFF	Specifies the maximum output level
EXP. THRE	-54.0 to -24.0 dB	Expander threshold
EXP. RAT	1:1 to ∞:1	Expander ratio
EXP. REL	*1	Expander release time
EXP. BYP	OFF, ON	Expander bypass
LIM. THRE	-12.0 to 0.0 dB	Limiter threshold
LIM. ATK	0–120 ms	Limiter attack
LIM. REL	*1	Limiter release time
LIM. BYP	OFF, ON	Limiter bypass
LIM. KNEE	0–5	Limiter knee
SOLO LOW	OFF, ON	If this is on, only the low-frequency band will be output.
SOLO MID	OFF, ON	If this is on, only the mid-frequency band will be output.
SOLO HIGH	OFF, ON	If this is on, only the high-frequency band will be output.

\*1. 6 ms–46.0 s (fs=44.1 kHz), 5 ms–42.3 s (fs=48 kHz)

## Troubleshooting

### Power does not turn on, operation not possible

#### ■ Power does not turn on

- Is the power cord connected to an AC outlet of the correct voltage?
- Is the POWER switch turned ON?
- If the power still does not turn on, please contact your Yamaha dealer.

#### ■ LCD display is dim or dark

- Use the contrast knob located at the lower right of the screen to adjust the contrast.

#### ■ Can't use the [DATA/JOG] dial to control on-screen parameters

- The [JOG ON] key may be on.
- Some parameters cannot be operated in certain states, such as while the recorder is running.

### No sound

#### ■ No sound, or sound is too faint

- Are speakers or headphones connected correctly?
- Is your amp and other external devices turned on?
- Are you using connection cables with built-in resistors?
- Does the stereo output channel meter move?
- Is the stereo output channel fader raised? Is it turned on?
- The EQ gain may be set to an extremely low value.
- The dynamics processor may be set to an extreme threshold or ratio.
- Is an electric guitar connected to a MIC/LINE INPUT jack directly?
- Is the attenuator of the EQ screen or CH VIEW screen raised?
  - Check the level (meter movement) in the METER screen.
  - If you move the cursor to the INITIALIZE button and press the [ENTER] key in the CH VIEW screen View page, that channel will be initialized to default values that allow sound to be output.
  - If DIGITAL IN is enabled in the TRACK screen, and no signal is being input to the DIGITAL STEREO IN jack, a message of "WRONG WORD CLOCK" will appear, and sound will not be output.

#### ■ Input sound is not output

- Is the signal from the external device being input?
- The connection cable from the external device may be broken.
- Are cables connected to both the MIC/LINE INPUT XLR connector and the TRS phone connector?
- Is the [GAIN] knob set to an appropriate level?
- Is the input channel fader raised? Is it turned on?
- The input channel may have been set to DIGITAL IN.
- When recording, is the recording-destination track fader (which adjusts the monitor level) raised?
  - If you are recording, the sound of that input channel will not be heard during playback.

#### ■ Recorded sound is not output

- Has audio data been recorded on the recorder?
- Is the virtual track set to the track that was recorded?
- A recorded region shorter than 10 msec will not be played back.
- Tracks 1–24 will not play back if the AW2400 is in Stereo Track, Sound Clip, or Audio CD playback mode.

#### ■ Can't play back the STEREO track

- Is the ST TR MODE turned on in the TRACK screen Stereo TR page?

#### ■ Metronome cannot be heard

- The metronome sound is normally sent only to the MONITOR OUT and headphones.
- The metronome will not sound while the recorder is stopped.
- In Sound Clip mode, the metronome will sound only during recording.

### Can't record, something is wrong with the recorded sound

#### ■ Can't record

- Is there sufficient free space on the internal hard disk?
  - You can check the remaining recordable time in the TRACK screen View page.
- The song may be protected.
- The stereo track may be in playback mode.
- Is the input signal routed appropriately to the recorder?
- Check the recording-source and recording-destination in the RECORD screen.
- Is CD/DAT DIGITAL REC set to ENABLE in the UTILITY screen Preference page?
- Please read and understand the copyright warning (→ p. 7) before using digital input signals.

#### ■ Can't record on the STEREO track

- It is not possible to record on the STEREO track while recording on other tracks.

■ **Noise is present in the recorded signal**

- The oscillator may be functioning.
- Does the word clock setting match for the AW2400 and the external device(s)?
- Go to the RECORD screen and check the recording-source and recording-destination.

■ **Can't select a record track**

- The number of 24-bit song tracks that can be recorded or played simultaneously is limited.

**Something wrong with the sound**

■ **Sound is distorted**

- Is the [GAIN] knob set correctly?
- The connection cable from the external device may be broken.
- The fader of the input channel or monitor channel may be raised excessively.
- The stereo output channel fader may be raised excessively.
- The stereo output channel attenuator may be raised excessively.
- The EQ or dynamics processor may have been set to produce an extreme gain boost.
- Did you record at an appropriate level?  
→ Go to the METER screen and check the level (meter movement).
- Is the word clock setting correct for both the AW2400 and the external device(s)?
- An effect such as Distortion or Amp Simulate may be in use.

■ **The volume of a particular channel increases or decreases**

- Are the dynamics processor settings appropriate?
- Is the Automix function engaged?

■ **Can't store a scene**

- The store-destination scene or song may be protected.
- A scene cannot be stored in scene number 00.

■ **Can't reproduce a scene**

- One or more channels may be set to Recall Safe.

■ **Can't save to a library**

- It is not possible to save to the factory-preset libraries.
- Is the song you are trying to save protected?

■ **Meters move even though the faders are lowered**

- The meter display may be set to PRE FADER or PRE EQ.

■ **Moving a fader does not change the level**

- Have you selected the correct mixing layer via the Layer section keys?
- The fader may be set to PRE FADE or PRE EQ.

■ **Pairing was specified, but the signal is monoaural**

- Is the odd-numbered channel panned far left and the even-numbered channel panned far right?

■ **Pairing was specified, but the signal phase does not match**

- Even when channels are paired, the phase setting is not linked.

■ **Signal is delayed**

- An effect such as delay may be inserted.

■ **Can't use the internal effects**

- Effect BYPASS may be turned ON.
- The effect may have been inserted into a different channel.
- Are the level of effect return channel faders raised?
- HQ. Pitch can be used only with EFFECT 1 or 2.
- These do not affect the stereo track, sound clip, or audio CD playback.

■ **Playback pitch is wrong**

- VARI PITCH may be adjusted.
- Is the synchronized external device operating on the same sampling frequency (44.1 kHz or 48 kHz)?
- Is the master device operating in a stable way?
- You may have executed the EDIT screen PITCH command.
- Is an effect such as HQ.Pitch or Dual Pitch selected for a monitor channel?

■ **A small amount of noise is produced when a song is played back on a different AW2400 unit**

- A small amount of noise may be heard at the beginnings and ends of audio regions when a song created on an AW2400 unit with Version 1.1 firmware is played back on an AW2400 with Version 1.0 firmware. Please update all AW2400 units you are using to the latest firmware version. Information on the latest firmware version as well as update procedure can be found at the internet address below.

<http://www.yamahasyth.com/>

■ **The sound and displays of some effects are different when a song is played back on a different AW2400 unit**

- When songs that include scenes or effect library using a Gate effect are loaded into an AW2400 with Version 1.0 firmware, Gate effects may be replaced by a Reverb Hall effect and some displays may not appear as expected. Please update all AW2400 units you are using to the latest firmware version. Information on the latest firmware version as well as update procedure can be found at the internet address below.

<http://www.yamahasyth.com/>

### Recorder operations

#### ■ When you press the [PLAY] key it blinks, and playback does not occur

- Is the AW2400 set to MTC SLAVE?  
→ Access the MIDI screen Setting 2 page, and check the setting.

#### ■ Can't edit a recorded track

- The song may be protected.
- Have you selected the virtual track that you recorded?

#### ■ Editing results are not heard in the sound

- Have you selected the virtual track that you recorded?
- Are you using the appropriate editing command?

#### ■ Counter display is not 0 when you return to the beginning of the song

- If the display mode is set to RELATIVE (relative time), the start point may be specified.  
→ Go to the SONG screen Setting page and TRACK screen View page and check the settings.

#### ■ Display indicates DISK FULL or REGION FULL, and you cannot record or edit

- There is insufficient free space, or too many recording regions. Erase unneeded tracks and then perform the Optimize operation to obtain more free space.
- If the "DISK FULL" message appears, erase unneeded songs or WAV files located under the "Transport" folder. The WAV files under the "Transport" folder can be erased from your computer when the USB Storage mode is engaged.

#### ■ The display indicates DISK BUSY during playback

- The recorded data might be so fragmented that the read speed is significantly reduced. It might be necessary to backup all hard disk data to your computer and then re-initialize the hard disk.
- If you're using the AW2400 with a Windows (or Mac OS X 10.4 or higher) computer, access performance can be improved by setting the cluster size to 64K when initializing the AW2400 internal hard disk. This reduces the occurrence of DISK BUSY.

### MIDI operations

#### ■ Can't exchange MIDI data

- Are the MIDI cables or USB cables connected correctly?
- A MIDI cable or USB cable may be broken.
- Is the power turned on for the transmitting and receiving devices?
- Do the channel settings match for the transmitted and receiving devices?
- Have the appropriate settings been made in the MIDI screen Setting 1/2 pages?  
→ Select the connector and port to be used (MIDI connector, USB connector port 1-3, or slot) in the Setting 1 page.
- Is a scene assigned to the program change number being transmitted?
- If a USB connection is being used, is the required USB-MIDI driver properly installed on your computer?

#### ■ MTC messages are not transmitted

- In the MIDI screen Setting 2 page, has the MTC button been turned on?
- Is MTC MASTER turned on?

#### ■ The AW2400 does not synchronize to incoming MTC messages

- Is the MIDI cable connected to the MIDI IN connector?
- In the MIDI screen Setting 2 page, is MTC SLAVE turned on?
- Is the connector and port to be used (MIDI connector, USB connector port 1-3, or slot) selected in the MIDI screen Setting 1 page?

#### ■ MTC synchronization drifts

- Is a large amount of MIDI data (notes etc.) being received together with the MTC messages?
- Does the frame rate match between the AW2400 and the external device?
- In the MIDI screen Setting 2 page, OFFSET may have been set.
- If jumps occur in the synchronized time, change the SYNC AVERAGE setting in the MIDI screen Setting 2 page, and try again.

#### ■ MMC messages is not transmitted

- Is the MIDI cable connected to the MIDI OUT connector?
- In the MIDI screen Setting 2 page, is MMC MASTER turned on? Does the DEVICE NO. match?

#### ■ Can't receive MMC messages

- Is the MIDI cable connected to the MIDI IN connector?
- In the MIDI screen Setting 2 page, is MMC SLAVE turned on? Does the DEVICE NO. match?

#### ■ Can't use the preset remote settings

- Depending on the sequencer that you want to control, you may need to make settings on the sequencer. For details, refer to page 266.
- Select the connector and port to be used (MIDI connector, USB connector port 1-3, or slot) in the MIDI screen Setting 1 page.

## Song operations

### ■ Can't save a file

- Is there sufficient space on the internal hard disk to create a new song?
- Did you perform the correct shut-down procedure when you last turned off the power?
  - Disconnecting the power without performing the shutdown operation will shorten the lifespan of the hard disk and CD-RW drive, may damage the hard disk and CD-RW drive and disc, and may result in loss of data.
- Is the internal hard disk be subjected to strong physical shock?

### ■ AW2816 backup files cannot be saved

- Songs with a large data size cannot be saved. Try executing the Optimize function from the SONG screen Song List page.

### ■ Song file size is unnaturally large

- Even after you use recorder editing operations to erase a track or other data, that sound file will remain on the disk. Execute the Optimize command in the SONG screen LIST page.

## CD operations

### ■ Can't create an audio CD

- Is CD-R/RW media inserted?
- The inserted CD-R may have already been finalized.
- Is a signal recorded on the stereo track?
- The stereo track must be at least four seconds long.
- Have you saved a song after the stereo track has been recorded?
- Audio CDs cannot be created using data recorded at the 48kHz sampling rate.

### ■ An audio CD you created does not play back on a conventional player

- An audio CD you created you not play back on a conventional player unless the disc has been finalized.

### ■ Audio recorded on CD-RW media does not play back on some players

- In order for audio data recorded on CD-RW media to be played back, the player must support CD-RW. Contact the manufacturer of the player regarding CD-RW support.

### ■ The sound skips while playing an audio CD that you created

- Depending on the CD-R media you use, there may be differences in the quality of the completed CD.

## WAV File Transfer To and From a Computer

### ■ The computer doesn't recognize the AW2400 hard disk

- Is the USB cable properly connected?
- Is your computer running the appropriate operating system?
  - Windows XP Professional/Home Edition SP1 or higher, or Mac OS X 10.3 or higher. Operation is not guaranteed with other operating systems.
- To use a Macintosh computer (running Mac OS X 10.3) it is necessary to first initialize the AW2400 hard disk with the cluster set to 32K.
- Is the USB storage mode turned ON?

### ■ Can't find WAV files copied from the computer to the Transport folder

- Have you copied WAV files with a different bit depth from the song? Have you copied WAV files with a different sampling frequency from the song?

### ■ Can't find WAV files copied from the computer to the Audio folder

- Did you change the bit depth of the WAV file when editing it with waveform editing software?
  - For 24-bit songs audio data is saved in the Audio folder in 32-bit WAV file format.
- Have you changed the file name?
- Did you copy the file(s) to a different folder?

### ■ Can't copy files from the computer

- Files larger than 4 GB cannot be copied.
- When connecting to a USB 2.0 connector of your computer, use a cable specified for USB 2.0.

### ■ An error message appears when disconnecting the AW2400 from a Windows computer

- Before turning the USB storage mode OFF, remove the device via the "Safely Remove Hardware" icon in the taskbar.
- Close all AW2400 windows before removing the device via the "Safely Remove Hardware" icon.
- If an error message still appears, execute "Safely Remove Hardware" one or two more times. You should then be able to remove the device without seeing an error message.

### Pitch Fix operations

#### ■ Can't hear any pitch change?

- Make sure that RATE is NOT set to 0.
- Make sure that BYPASS is off.

#### ■ The voice is not recognized

- When the voice is high, set TYPE to FEMALE; when it is low, set TYPE to MALE.

#### ■ Pitch correction doesn't sound right

- In some cases, pitch correction may sound unnatural — especially for parts sung with vibrato. To make the pitch-corrected vocal sound more natural and subtle, set DETECT to a relatively short value and set RATE to a relatively slow value.

### Automix operations

#### ■ Can't record Automix operations

- Is ENABLE selected in the AUTOMIX page?
- Is the REC or AUTO REC button on?
- Is the type of data to be recorded (fader, EQ, etc.) selected in the OVERWRITE field?
- Is the [INPUT SEL], [SEL], or [STEREO SEL] key of the target channel flashing?

### Trigger Track operations

#### ■ Playback sound is interrupted at the boundaries of the recorded data

- Use the EXPORT command to export the required section of audio data as a WAV file, then use the IMPORT USB WAV command to re-import the WAV file to the track.

#### ■ Operating the [ON] key or fader doesn't start playback

- The channel may be turned off before the Trigger Track mode is engaged.  
→ Call the CH VIEW screen and turn on the channel.

## Display message list

### ■ Messages

<b>A/B POINTS NOT FOUND</b>	Repeat Playback cannot be performed because A/B points are not specified.
<b>AUTOMIX ABORTED!</b>	Automix recording has been aborted.
<b>AUTOMIX DISABLED!</b>	Automix is currently disabled. Please set to ENABLE.
<b>AUTOMIX MEMORY FULL!</b>	Not enough memory available for automix.
<b>AUTOMIX RUNNING!</b>	That operation cannot be performed while automix is running.
<b>CANNOT DEFEAT MUTE</b>	Mute cannot be disengaged because the simultaneous playback limit will be exceeded.
<b>CANNOT REDO</b>	Redo (re-execution of an operation) is not possible.
<b>CANNOT SET MARK</b>	It is not possible to specify a marker at an already-specified position.
<b>CANNOT UNDO</b>	Undo (cancellation of an operation) is not possible.
<b>CD PLAY MODE NOW</b>	Since the AW2400 is in CD Play mode, this operation cannot be executed.
<b>CH. PARAMETER INITIALIZED</b>	The mixer parameters of the channel have been initialized.
<b>DIFFERENT TC FRAME TYPE</b>	MTC of a different frame type than the internal setting is being received.
<b>DIGITAL-ST-IN REC PROHIBIT.</b>	Recording of digital input signals is prohibited.
<b>DISK BUSY!!</b>	The reading speed of the internal hard disk is not fast enough, or the reading speed has slowed down because the recorded data has become fragmented.
<b>DISK FULL!!</b>	There is insufficient space on the internal hard disk.
<b>IN/OUT POINTS NOT FOUND</b>	Auto-punch recording cannot be performed because in/out points are not specified.
<b>IN/OUT POINTS REVERSE ORDER</b>	In/out points are set in wrong order.
<b>IN/OUT POINTS TOO CLOSE</b>	The auto punch-in/out interval is too short. It cannot be set less than approximately 100 msec.
<b>LOCATE POINT ERASED</b>	The locate point has been erased.
<b>LOCATE POINT SET</b>	The locate point has been set.
<b>MARK POINT ERASED</b>	The marker has been erased.
<b>MARK POINT SET</b>	The marker has been set.
<b>MIDI IN: DATA FRAMING ERROR!</b>	Invalid MIDI data may have been received.
<b>MIDI IN: DATA OVERRUN!</b>	Invalid MIDI data may have been received.
<b>MIDI: RX BUFFER FULL!</b>	Receiving more MIDI data than it can handle.
<b>MIDI: TX BUFFER FULL!</b>	Attempting to transmit more MIDI data than it can handle.
<b>MTC SLAVE MODE NOW</b>	Since the AW2400 is in MTC Slave mode, this operation cannot be executed.
<b>NO DATA TO COPY!</b>	There is no data to be copied.
<b>NO MARK LEFT</b>	The allowable number of marks has been exceeded.
<b>NOTHING TO UNDO!</b>	Not data available for undo.
<b>RECORD TRACK NOT SELECTED</b>	Recording cannot be performed because you have not selected a record track.
<b>RECORDER BUSY!</b>	The operation cannot be executed because the recorder is operating.
<b>RECORDER RUNNING NOW</b>	Since the recorder is recording or playing, this operation cannot be executed.
<b>REDO COMPLETED</b>	Redo (re-execution of the previous operation) has been completed.
<b>REPEAT POINTS TOO CLOSE</b>	The repeat interval is too short. It cannot be set to less than one second.
<b>SELECTED CH IS NONE.</b>	The selected channel is not available.
<b>SET OVERWRITE!</b>	Please specify the automix parameters to be overwritten in the OVERWRITE field.
<b>SOUND CLIP MODE NOW</b>	Since the AW2400 is in Sound Clip mode, this operation cannot be executed.
<b>STEREO TRACK PLAYBACK MODE</b>	Since the AW2400 is in Stereo Track Playback mode, this operation cannot be executed.

<b>THIS SONG IS PROTECTED.</b>	This song is protected, and cannot be edited or recorded.
<b>TOO MANY REGIONS!!</b>	The maximum allowable number of regions* has been exceeded.
<b>TRIGGER TRACK MODE NOW</b>	Since the AW2400 is in Trigger Track mode, this operation cannot be executed.
<b>UNDO COMPLETED</b>	Undo (cancellation of the previous operation) has been executed.
<b>USB STORAGE MODE NOW</b>	Since the AW2400 is in USB Storage mode, this operation cannot be executed.
<b>WRONG WORD CLOCK</b>	An inappropriate word clock is being received from the connected device to which you are synchronizing.
<b>Y96K COULDN'T RECALL</b>	Scene memory numbers 97 or higher cannot be recalled when using a Y96K card.
<b>Y96K COULDN'T STORE</b>	Scene memory numbers 97 or higher cannot be stored when using a Y96K card.

\* A region is a continuous segment of audio data recorded on one track.

### ■ Popup messages

<b>Buffer Underrun!</b>	A buffer underrun error was encountered while writing to the CD.
<b>Can't Select Current Song!</b>	The current song cannot be selected for this operation.
<b>CD Import Prohibited! Enable DIGITAL REC.</b>	Can't import from a CD because DIGITAL REC is prohibited.
<b>CD or HD Access Error!</b>	An error was encountered while accessing the internal hard disk or CD-RW drive.
<b>CD-RW Drive Not Found!</b>	A problem occurred with the CD-RW drive.
<b>Change Media, Not 1st Media.</b>	Wrong media order. Please insert media number 1.
<b>Change Media, Different Archive ID!</b>	The medium contains the wrong backup file. Insert the correct medium.
<b>Change Media, Wrong Media Order!</b>	Please exchange the media. The order of media volumes is incorrect.
<b>Compare Error!</b>	The data was not written correctly.
<b>Corrupt File!</b>	The file is corrupt.
<b>Data Mismatch Found!</b>	A data mismatch has been found in the song.
<b>End of Archive File Not Found!</b>	The end of the backup file cannot be located.
<b>End Range Over!</b>	The operation could not be executed, since the end of the song would be later than 24 hours.
<b>File in Use!</b>	Can't save, erase, or edit the title because the file is in use.
<b>File List Full!</b>	The file list is full and cannot be appended.
<b>File Name Already Exists!</b>	The specified file name already exists. Use a different file name.
<b>File Number Full!</b>	No more songs can be created or restored, since this would exceed the maximum number of files.
<b>File Size Exceeds Limit!</b>	The file is too large to be saved.
<b>For Effect 1 or 2 Only!</b>	The selected effect type is for use with Effect 1 or Effect 2 only.
<b>HD Full!</b>	The internal hard disk is full and can accept no more data.
<b>HD Status is Out of Range!</b>	The hard disk reliability status (the number of past errors) has exceeded the threshold. Back up your data and have the hard disk replaced as soon as possible.
<b>HDD Error!</b>	A problem occurred with the internal hard disk.
<b>Illegal/Unsupported Media!</b>	An unrecognized or unsupported medium has been inserted.
<b>Invalid Parameter!</b>	The parameter setting exceeds the allowable range.
<b>Invalid Region!</b>	An invalid region has been specified.



<b>Marker Interval Under 4 sec!</b>	Since the song length divided by the markers would be less than four seconds, you cannot divide it with a marker.
<b>Media Too Small. Cannot Save!</b>	The medium does not have enough space available to save the data.
<b>No Data to Backup!</b>	No data is selected for backup.
<b>No Data to Restore!</b>	No data is selected for restore.
<b>No Data!</b>	No data exists, or there is no data (region*) in the selected area.
<b>No File!</b>	Can't save, erase, or edit the title because no file is found.
<b>No Media!</b>	Media has not been inserted.
<b>No Region!</b>	No region* is found.
<b>No Song to Write!</b>	No songs to write to the CD have been selected.
<b>No Stereo Track!</b>	There is no song that includes a master track longer than four seconds.
<b>Not 44.1kHz/16Bit Song!</b>	The song cannot be restored since it is not a 44.1 kHz/16-bit song.
<b>Number Ejected Media, Insert Blank Media.</b>	Make a note of the number of the medium which has been written to, then insert a blank medium.
<b>Number of Media Exceeds Limit!</b>	The maximum number of media that can be handled at the same time has been exceeded.
<b>Protected!</b>	Can't edit the file because it is protected.
<b>Read Only File!</b>	Can't save, erase, or edit the title because the file is read-only.
<b>Read Only!</b>	Read-only library! This library cannot be saved, erased, or title-edited.
<b>Recall Channel Data Conflict!</b>	The selected library data cannot be properly loaded into the specified channel.
<b>Recognized AW2816-Formatted Media!</b>	The media is written in AW2816 format.
<b>Recognized AW4416-Formatted Media!</b>	The media is written in AW4416 format.
<b>Region Full!</b>	The maximum allowable number of regions* has been exceeded.
<b>Selected Channel has no Comp!</b>	There is no compressor on the selected channel.
<b>Selected Channel has no EQ!</b>	There is no EQ on the selected channel.
<b>Selected Channel has no Gate!</b>	There is no gate on the selected channel.
<b>Song Too Large to Export!</b>	The song file is too large to be exported.
<b>System Error!</b>	An internal system error has occurred.
<b>This Song is Protected!</b>	Can't save, erase, or edit the title because the song is protected.
<b>Too Long Data!</b>	No more data can be written because the capacity of the CD has been exceeded.
<b>Too Many CD Tracks!</b>	No new tracks can be added because the maximum number of allowable tracks has been exceeded.
<b>Track Not Recorded!</b>	The track you selected does not contain any recorded data.
<b>Used As Effect Insert!</b>	This port is already in use as an effect insert.
<b>Wave File Link Error!</b>	A WAV file link error has been found.
<b>Wrong Bit Depth!</b>	The bit depth of the selected file is incorrect.
<b>Wrong File Format!</b>	The selected file is not PCM format.
<b>Wrong HD Format!</b>	The internal hard disk is incorrectly formatted. The disk cannot be formatted from a computer.
<b>Wrong Number of Channels!</b>	The number of channels in the selected file is incorrect.
<b>Wrong Sampling Frequency!</b>	The sampling rate of the selected file is incorrect.
<b>Wrong Wav Chunk Data!</b>	The WAV file's chunk data is incorrect.
<b>Wrong Wav File!</b>	The WAV file cannot be used.

\* A region is a continuous segment of audio data recorded on one track.

## About the CD-ROM included with the AW2400

### Special Notices

- The software and this owner’s manual are the exclusive copyrights of Yamaha Corporation.
- Use of the software and this manual is governed by the license agreement which the purchaser fully agrees to upon breaking the seal of the software packaging. (Please read carefully the Software Licensing Agreement at the end of this manual before installing the application.)
- Copying of the software or reproduction of this manual in whole or in part by any means is expressly forbidden without the written consent of the manufacturer.
- Yamaha makes no representations or warranties with regard to the use of the software and documentation and cannot be held responsible for the results of the use of this manual and the software.
- This disk is a CD-ROM. Do not attempt to play the disk on an audio CD player. Doing so may result in irreparable damage to your audio CD player.
- Future upgrades of application and system software and any changes in specifications and functions will be announced separately.

### Contents of the CD-ROM

The included CD-ROM contains a backup file that you can use to restore the AW2400 to its factory-set condition, setting files that let you use the AW2400’s MIDI Remote function with various DAW software, and a USB MIDI driver that is necessary to allow MIDI message transmission and reception via the USB connector.

Folder/ file name	Software name	Contents
AW24_000.TAR	Demo song	Backup file for restoring the internal hard disk to its factory-set condition.
Remote	Cubase/Nuendo remote setup file	Setting file for remotely controlling the Cubase/Nuendo software from the AW2400.
	Logic preference file	Setting file for remotely controlling the Logic software from the AW2400.
	SONAR template file (Windows only)	Setting file for remotely controlling the SONAR software from the AW2400.
USBdrv_	Yamaha USB MIDI Driver	Driver file for exchanging MIDI messages between the AW2400 and a computer via a USB cable.

### Installing USB MIDI driver

If you are connecting the AW2400 to your computer via a USB cable for MIDI message transmission and reception, you need to install the Yamaha USB MIDI driver.

#### System Requirements

OS: Windows XP Professional/Home Edition SP1 or higher, or Mac OS X 10.3 or higher

#### Installing on Windows XP

- 1 Start your computer to launch Windows, then log in as Administrator.
- 2 Click the [Start] button, and then click [Control Panel].  
If the control panel appears as “Pick a category”, click “Switch to Classic View” in the upper left of the window. All control panels and icons will be displayed.
- 3 Go to [System Hardware] → [Driver signatures] → [Driver signature options], select “Ignore — Install software without asking for confirmation,” and then click [OK].
- 4 Click [OK] to close the “System Properties” window, and then click the Close button to close the “Control Panel” window.
- 5 Insert the included CD-ROM into the CD-ROM drive.
- 6 First, make sure the POWER switch on the AW2400 is set to STANDBY, then use a USB cable to connect the USB connector of the computer to the USB connector of the AW2400. When the AW2400 is turned on, the computer automatically displays the “Found New Hardware Wizard.”
- 7 If the “Can Windows connect to Windows Update to search for software?” is displayed, select “No, not this time”, and then click [Next].
- 8 Select “Install software automatically (recommended) (I),” and then click [Next].  
The system starts the installation.



• Some computers may take a few minutes to show this screen.

- 9** When the installation is complete, the system displays “Completing the Found New Hardware Wizard.” Click [Finish].

**NOTE**

- Some computers may take about a few minutes to show this screen after the installation is complete.

- 10** Restart the computer.  
The driver has been installed.

## ■ Installing on Macintosh computer

- 1** Start your computer, then log in as Administrator.

To confirm that the Administrator account is available, select [System Preferences], then [Users (Account)].

- 2** Double-click the “USBdrv\_” folder on the included CD-ROM.

- 3** Double-click “YAMAHA USB-MIDI Driver v1.\*\*\*\*\*.mpkg” (\*\*\*\*\* represents the version number).

An “Authenticate” window opens, prompting the password.

If the window does not prompt you to enter the password, click the lock icon.



- 4** Enter the password for the Administrator’s account. If you have not set the password, click [OK].

The “Welcome to the YAMAHA USBMIDI Driver Installer” window is displayed.



- 5** Click [Continue].

The “Select a Destination” is displayed.



- 6** Select a destination for the driver installation, then click [Continue].

The message “Installing this software requires 100MB of disk space” may appear. However, the actual required free disk space is 2MB.

- 7** A window opens, displaying the message “Click install to perform a basic installation of this software.” Click [Install].

If the driver has already been installed, the [Upgrade] button is displayed instead of the [Install] button.

The driver is installed, and message “The software was successfully installed” is displayed.

- 8** Click the [Close] button.

The driver installation is complete.

You can check the following locations to confirm that the driver has been installed:

- Library → Audio → MIDI Drivers → YAMAHAUSBMIDIPlugin.plugin
- Library → PreferencePanes → YAMAHAUSBMIDIPatch.prefPane

## Restoring the internal hard disk to the factory-set condition

In order to restore the internal hard disk to the factory-set condition, you will need to perform the following two procedures.

- ① Initialize the internal hard disk
- ② Load the demo song

### ■ Initializing the internal hard disk

Initialize the internal hard disk. (→ p. 212)

When you initialize the internal hard disk, the system settings will return to their factory-set state.

#### NOTE

- Executing this operation will erase all data from the internal hard disk, and the data cannot be recovered. We recommend you to backup all data on the internal hard disk to a computer before executing this operation.

### ■ Loading the demo song

You can load the demo song from the included CD-ROM to restore the AW2400 to its factory-set condition.

- 1 Insert the included CD-ROM into the CD-RW drive of the AW2400.
- 2 Call the SONG screen Restore page by either pressing the Work Navigate section [SONG] key as many times as necessary.
- 3 Make sure that the cursor is located at the READ CD INFO button, and press the [ENTER] key.

Loading from the CD-ROM will begin. When loading is finished, the contents of the display will change as follows.

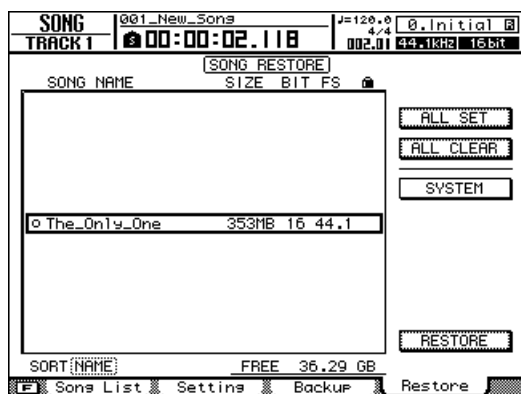

- 4 Move the cursor to the list and press the [ENTER] key.  
The symbol at the left of the list will change to “●”.

- 5 Move the cursor to the RESTORE button and press the [ENTER] key.

- 6 A popup window will ask you for confirmation, so move the cursor to the OK button or CANCEL button, and press the [ENTER] key.  
While the Restore operation is being executed, the state of progress will be shown in a popup window. When this popup window closes, the operation has been completed.

## Installing a remote file

### ■ Supported DAW software

#### • Windows

- Logic Platinum 5.5.1 (\*1)
- Cubase SX 3.0.1
- Nuendo 3.0.1
- Sonar 4.0.1 Producer Edition

#### • Macintosh

- Logic Pro 7.0.1 (\*1)
- Cubase SX 3.0.1
- Nuendo 3.0.1
- Protools TDM 6.7 (\*2)

\*1 Use the setting file from the included CD-ROM to map the AW2400's faders/[ON] keys/transport keys to the Logic key commands. Track assignments must be made within Logic as appropriate for your system.

\*2 Select the CS-10 settings as the MIDI controller type. For details on the CS-10 settings, ask Digidesign.

## Windows users

**NOTE**

- In order to use a remote file, the corresponding software must be installed.
- Please be aware that the menu names and screens that appear in the explanation below may differ depending on the software you are using.

### ● Installing the Cubase/Nuendo remote setup file

- 1 Start up Cubase/Nuendo.
- 2 In the menu bar, select [Devices] menu → [Device Setup...].
- 3 The Device Setup window will appear. Select [Add Device] → [Generic Remote].

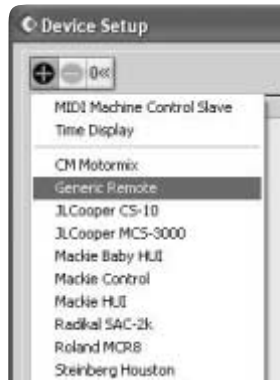

- 4 The Generic Remote setting display will appear. Set the “MIDI Input” and “MIDI Output” filed.

MIDI Output : your MIDI output device  
MIDI Input : your MIDI input device

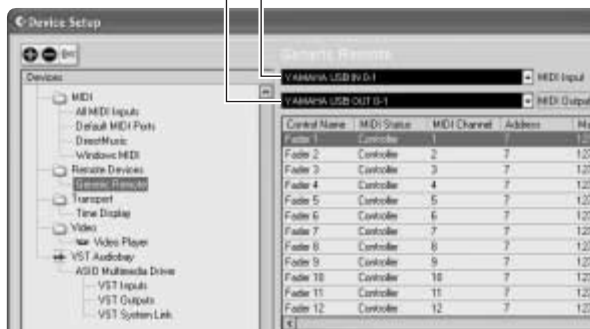

**NOTE**

- The content that is shown for “MIDI Input” and “MIDI Output” will depend on the MIDI device(s) you are using. For details, refer to the owner’s manual for the MIDI device(s) you are using.

- 5 Click the [Import] button.

- 6 A dialog box like the following will appear. Select the Cubase/Nuendo remote setup file (Yamaha AW2400 Remote.xml) from the included CD-ROM, and click the [Open] button.

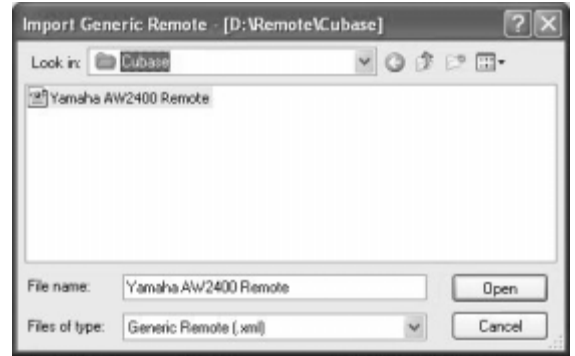

- 7 Close the Device Setup window.

Fader and [ON] key operations can be used to control Cubase/Nuendo audio tracks. Create new projects with more than 16 audio tracks.

### ● Installing the Logic preference file

- 1 Start up Logic.
- 2 In the menu bar, select [Options] menu → [Preferences] → [Key Commands...].
- 3 The Key Commands window will open. In the menu bar, select [Options] → [Import Key Commands...].
- 4 A dialog box will appear. Select the Logic preference file (Logic32.prf) from the included CD-ROM, and click the [Open] button.

When you import the file, the following settings will be made.

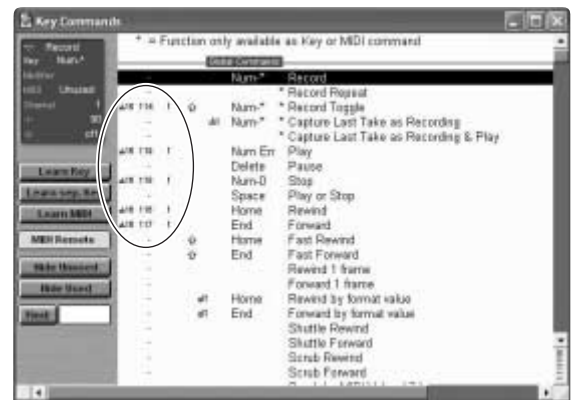

\* Please note that all the previously-specified key commands will be initialized. If you do not want to change your existing user key command settings, you can manually make the MIDI channel and CC# settings shown above.

● **Installing the SONAR template file**

- 1 Copy the SONAR template file from the included CD-ROM to the folder in which SONAR is installed.
- 2 Start up SONAR.
- 3 In the menu bar, select [File] menu → [Open].
- 4 The “Open file” dialog box will appear. Choose Cakewalk template files as the type of file to be loaded. From the list in the dialog box, choose “Yamaha AW2400 Remote” and click the [OK] button.
- 5 In the menu bar, select [Option] → [MIDI Devices].
- 6 The MIDI Ports window will open. In the Input Ports field, assign the MIDI device that you are using.

**If you changed the track structure from the default settings of the template ...**

With the Yamaha AW2400 Remote template started, click the [CONFIG] button in the StudioWare panel window. A cluster will open at the right. Drag the [SET MIDI First Track] knob to the first track number of the MIDI tracks.

- \* If you use this template, you will not be able to control the tracks correctly from the AW2400 unless the MIDI tracks are continuous from 1–16.
- \* If you set the value to an invalid track (an unused track), the panel knobs, buttons, or sliders may be shaded. If this occurs, set the value back to the correct track.

■ **Macintosh users**



- In order to use a remote file, the corresponding software must be installed.
- Please be aware that the menu names and screens that appear in the explanation below may differ depending on the software you are using.

● **Installing the Cubase/Nuendo remote setup file**

For Cubase/Nuendo, the procedure is the same as for the Windows version. (→ p. 269).

● **Installing the Logic Pro preference file**

- 1 Start up Logic Pro.
- 2 In the menu bar, select [Logic Pro] menu → [Preferences] → [Key Commands...].
- 3 The Key Commands window will open. In the menu bar, select [Options] → [Import Key Commands].
- 4 A dialog box will appear. Select the Logic preference file (Logic Preferences) from the included CD-ROM, and click the [Open] button.

When you import the file, the following settings will be made.

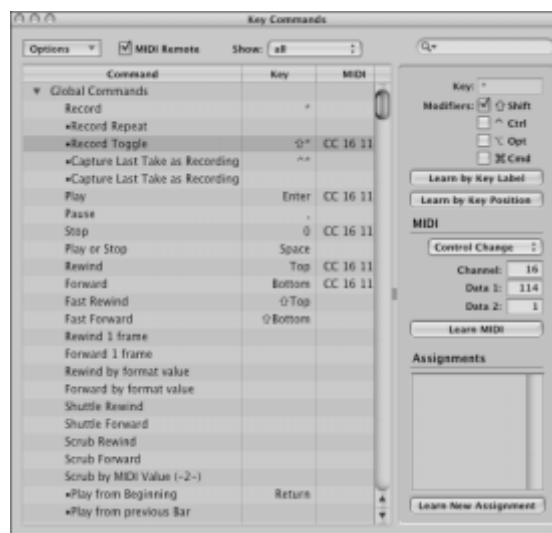

- \* Please note that all the previously-specified key commands will be initialized. If you do not want to change your existing user key command settings, you can manually make the MIDI channel and CC# settings shown above.

### ● Setting Pro Tools remote control

You can remotely control the Pro Tools software from the AW2400. No special setting file is required. Use the following procedure to make settings.

**1** In the menu bar, select **[Setup]** → **[Peripherals...]**.

**2** The **Peripherals** window will open. Click the **[MIDI Controllers]** button.

In the MIDI Controllers window, make the following settings. In the Receive From field and the Send To field, specify the MIDI device you are using.

	Type	Receive From	Send To	#ch's
#1	CS-10	Your MIDI input device	Your MIDI output device	16

This completes preparations for using the AW2400's MIDI Remote function to control the Pro Tools software.

## MIDI data format

### 1. Functions

#### 1.1. Scene Change

The settings of the [MIDI PROGRAM CHANGE TABLE] specify the scene that is recalled when a Program Change message is received.

The settings of the [MIDI PROGRAM CHANGE TABLE] specify the program number that is transmitted when a scene is recalled. If more than one program number has been assigned to that scene memory number, the lowest-numbered program number will be transmitted.

#### 1.2. MMC Control

These messages allow basic recorder operations such as STOP/PLAY/REC/LOCATE.

If you select the MIDI SETUP menu item MMC MASTER, MMC commands will be transmitted according to the operation of the transport. If you select MMC SLAVE, the internal recorder will operate according to the received MMC commands.

#### 1.3. Effect Control

Depending on the type of effect, note-on/off messages can be used for control.

These settings are made for the parameters of each effect.

#### 1.4. Pitch Fix Control

When the Pitch Fix mode is engaged, note-on/off messages can be used to control pitches.

#### 1.5. MIDI Clock transmission

If you set MIDI OUT to MIDI CLOCK, MIDI clock messages can be transmitted during playback or recording.

In MIDI Clock transmission mode, Song Position Pointer and Start/Stop/Continue commands will also be issued, and during playback or recording, MIDI Clock will be transmitted according to the MIDI Tempo Map.

#### 1.6. MTC transmission (MTC Master)

If you set MIDI OUT to MTC, MTC can be transmitted during playback or recording.

#### 1.7. MTC reception (MTC Slave)

If you set MTC MODE to SLAVE, the internal recorder will operate in synchronization with MTC messages received from the MIDI IN connector.

#### 1.8. Realtime control of parameters

Control changes can be used to send/receive internal parameters in realtime.

#### 1.9. MIDI Remote

The faders, ON keys, and RTZ / FF / REW / STOP / PLAY / REC keys can be used to control an external MIDI device.

In PRESET mode, operating the above controllers will transmit MIDI data according to the preset settings of the AW2400.

In USER mode, operating the above controllers will transmit the MIDI data that you specify.

### 2. MIDI data flow diagram

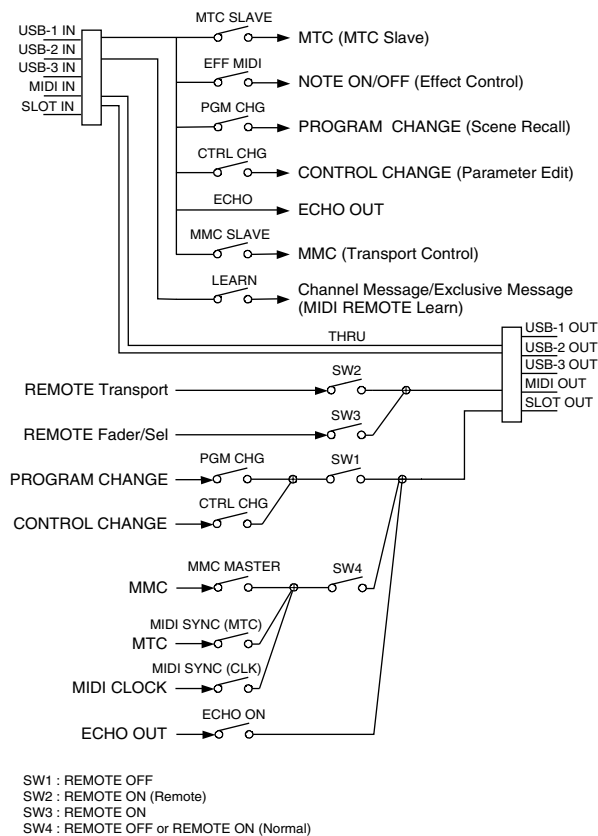

### 3. AW2400 settings and operation

#### 3.1. MIDI Setup

Set basic MIDI operation.

##### 3.1.1. Tx PORT

Specify the output port for MIDI communication.

##### 3.1.2. Rx PORT

Specify the input port for MIDI communication.

##### 3.1.3. MIDI Tx Ch

This sets the MIDI channel that will be used for transmission.

##### 3.1.4. MIDI Rx Ch

This sets the MIDI channel that will be used for reception.

##### 3.1.5. PROGRAM CHANGE MODE

Enable/disable reception and transmission. If MIDI Rx Ch is set to OMNI, these messages will be received regardless of their MIDI channel. If MIDI Tx Ch is set to ECHO, the received messages will be echoed at the transmission port.

##### 3.1.6. CONTROL CHANGE MODE

Enable/disable reception and transmission. If this is enabled, you can specify the correspondence between control numbers and operations of the mixer section. Three modes are available for correspondence with control numbers. For mode 1, transmission and reception will occur without regard to the MIDI Tx Ch and MIDI Rx Ch settings. For modes 2 and 3, reception will occur without regard to MIDI channel if you set MIDI Rx Ch to OMNI.

If MIDI Tx Ch is set to ECHO, the received messages will be echoed at the transmission port.



### 3.1.7. OTHER

If this is set to ECHO, the received MIDI data will be echoed at the transmission port. However, Program Change and Control Change will follow their own settings.

### 3.1.8. REMOTE PORT

Specify the output port when the MIDI remote function is engaged.

### 3.1.9. THRU

Set the MIDI through function.

### 3.1.10. MMC MODE

Select whether the AW2400 will be the MMC MASTER or SLAVE.

### 3.1.11. MMC Dev.

Specify the ID number that will be used when transmitting or receiving MMC commands.

### 3.1.12. MTC SYNC MODE

Select whether the AW2400 will be the MTC MASTER or SLAVE.

### 3.1.13. MTC SYNC AVERAGE

When the AW2400 is functioning as a MTC SLAVE, this setting specifies how it will follow the MTC data. Set this to 0 if the incoming MTC data has a highly accurate timing; set this to 1 or 2 if the timing of the incoming MTC data is not as accurate (such as when receiving MTC from a software sequencer).

### 3.1.14. MTC SYNC OFFSET

When the AW2400 is functioning as a MTC SLAVE, this setting adds an offset to the received MTC data. The received time code value shifted by this amount will correspond to the location indicated by the internal time code of the AW2400.

### 3.1.15. SYNC OUT

Turn on/off the output of MTC/MIDI CLOCK.

## 4. MIDI format list

### 4.1. CHANNEL MESSAGE

	Command	Rx/Tx	function
8n	NOTE OFF	Rx	Control the internal effect
9n	NOTE ON	Rx	Control the internal effect
Bn	CONTROL CHANGE	Rx/Tx	Edit parameters
Cn	PROGRAM CHANGE	Rx/Tx	Switch scene memories

### 4.2. SYSTEM COMMON MESSAGE

	Command	Rx/Tx	function
F1	MIDI TIME CODE	Rx/Tx	MTC transmission
F2	SONG POSITION POINTER	Tx	Song position transmission

### 4.3. SYSTEM REALTIME MESSAGE

	Command	Rx/Tx	function
F8	TIMING CLOCK	Tx	MIDI Clock transmission
FA	START	Tx	Start command transmission
FB	CONTINUE	Tx	Continue command transmission
FC	STOP	Tx	Stop command transmit
FE	ACTIVE SENSING	Rx	Check MIDI cable connections
FF	RESET	Rx	Clear running status

## 4.4. SYSTEM EXCLUSIVE MESSAGE

### 4.4.1. REALTIME SYSTEM EXCLUSIVE

#### 4.4.1.1. MMC

	Command	Rx/Tx	function
01	STOP	Rx/Tx	Transport stop
02	PLAY	Rx	Transport play
03	DEFERRED PLAY	Rx/Tx	Transport play
04	FAST FORWARD	Rx/Tx	Transport fast-forward
05	REWIND	Rx/Tx	Transport rewind
06	RECORD STROBE	Rx	Transport punch-in record
07	RECORD EXIT	Rx	Transport punch-out
0F	RESET	Rx/Tx	MMC reset
44	LOCATE	Rx/Tx	Transport locate

## 5. MIDI format details

### 5.1. NOTE OFF (8n)

#### < Reception >

Received when [Rx CH] matches.

Used to control Effects/Pitch Fix. Refer NOTE ON for details.

STATUS	1000nnnn	8n	Note Off Message
DATA	0nnnnnnn	nn	Note No.
	0vvvvvvv	vv	Velocity (ignored)

### 5.2. NOTE ON (9n)

#### < Reception >

Received when [Rx CH] matches.

Used to control Effects/Pitch Fix. Refer below for details.

Velocity of 0x00 is equivalent to Note-Off.

STATUS	1001nnnn	9n	Note On Message
DATA	0nnnnnnn	nn	Note No.
	0vvvvvvv	vv	Velocity (1-127:On, 0:Off)

\* Effect control by Note

1: Dynamic Flange/Dynamic Phase/Dynamic Filter

When the SOURCE parameter is set to MIDI, the note velocity (both note-on and note-off) is used to control the Modulation frequency width.

### 5.3. CONTROL CHANGE (Bn)

#### < Reception >

If [Control Change Rx] is On, control change messages will be received when [MIDI Rx Ch] matches. However, if [MIDI Rx Ch] is OMNI or [Control Change Mode] is 1, reception will occur regardless of MIDI channel.

#### < Transmission >

If [Control Change Tx] is On, control change messages will be transmitted on the [MIDI Tx Ch] channel when you operate a parameter.

STATUS	1011nnnn	Bn	Control Change
DATA	0ccccccc	cc	Control No. (0-95, 102-119)
	0vvvvvvv	vv	Control Value (0-127)

The control value is converted into a parameter value according to the following equation.

S= total number of steps in the parameter's variable range

$128 / S = X$  remainder Y

$INT((Y+1)/2) = Z$

If (MIDI DATA - Z) < 0, then Value = 0

If ((MIDI DATA - Z)/X) > MAX, then Value = MAX

Otherwise, Value = INT ((MIDI DATA - Z)/X)

## 5.4. PROGRAM CHANGE (Cn)

### < Reception >

If [Program Change Rx] is On, program change messages will be received when [MIDI Rx Ch] matches. However, if [MIDI Rx Ch] is OMNI, this message is received regardless of the channel.

A scene memory will be recalled according to the [PROGRAM CHANGE TABLE] settings.

### < Transmission >

If [Program Change Tx] is On, a program change will be transmitted on the [MIDI Tx Ch] according to the [PROGRAM CHANGE TABLE] settings when you recall a memory. If the recalled memory number has been assigned to more than one program number, the lowest-numbered program number will be transmitted.

```
STATUS 1100nnnn Cn Program Change
DATA 0nnnnnnn nn Program No. ( 0-127)
```

## 5.5. MIDI TIME CODE QUARTER FRAME (F1)

### < Transmission >

If [SYNC OUT] is set to MTC, Quarter Frame messages will be transmitted according to the time code movements of the recorder when the recorder is playing or recording.

### < Reception >

This message is received if [MTC SYNC MODE] is set to SLAVE. Quarter Frame messages received in realtime are internally assembled into time code that controls the recorder.

```
STATUS 11110001 F1 Quarter Frame Message
DATA 0nnndddd dd nnn = message type (0-7) dddd = data
```

## 5.6. SONG POSITION POINTER (F2)

### < Transmission >

If [SYNC OUT] is MIDI CLOCK, a song position message will be transmitted when STOP or LOCATE is performed on the recorder, to indicate the song position from which the song should start at the next START or CONTINUE message.

```
STATUS 11110010 F2 Song Position Pointer
DATA 0ddddddd dd0 data ( H) high 7 bits of 14 bits data
0ddddddd dd1 data ( L) low 7 bits of 14 bits data
```

## 5.7. TIMING CLOCK (F8)

### < Transmission >

If [SYNC OUT] is MIDI CLOCK, this message is transmitted according to the MIDI Tempo Map from when the recorder begins playing or recording, until it stops.

```
STATUS 11111000 F8 Timing Clock
```

## 5.8. START (FA)

### < Transmission >

If [SYNC OUT] is MIDI CLOCK, this message is transmitted when the recorder begins playing or recording at a location other than the first measure.

```
STATUS 11111010 FA Start
```

## 5.9. CONTINUE (FB)

### < Transmission >

If [SYNC OUT] is MIDI CLOCK, this message is transmitted when the recorder begins playing or recording at a location other than the first measure.

```
STATUS 11111011 FB Continue
```

## 5.10. STOP (FC)

### < Transmission >

If [SYNC OUT] is MIDI CLOCK, this message is transmitted when the recorder stops.

```
STATUS 11111100 FC Stop
```

## 5.11. ACTIVE SENSING (FE)

### < Reception >

Once this message is received, subsequent failure to receive any message for a period of 300 ms will cause Running Status to be cleared, and MIDI communications to be initialized.

```
STATUS 11111110 FE Active Sensing
```

## 5.12. RESET (FF)

### < Reception >

When a Reset message is received, MIDI communications will be initialized by clearing Running Status etc.

```
STATUS 11111111 FF Reset
```

## 5.13. EXCLUSIVE MESSAGE (F0-F7)

### 5.13.1. MMC

#### 5.13.1.1. MMC STOP

##### < Transmission >

When the STOP key is pressed, this message is transmitted with a device number of 7F.

##### < Reception >

If the AW2400 is operating as an MMC Slave, the transport will stop when this message is received with a matching device number or a device number of 7F.

```
STATUS 11110000 F0 System Exclusive Message
ID No. 01111111 7F Real Time System Exclusive
Device ID 0ddddddd dd Destination (00-7E, 7F:all call)
Command 00000110 06 Machine Control Command (mcc) sub-id
00000001 01 Stop (MCS)
EOX 11110111 F7 End Of Exclusive
```

#### 5.13.1.2. MMC PLAY

##### < Reception >

If the AW2400 is operating as an MMC Slave, the transport will begin playback when this message is received with a matching device number or a device number of 7F.

```
STATUS 11110000 F0 System Exclusive Message
ID No. 01111111 7F Real Time System Exclusive
Device ID 0ddddddd dd Destination (00-7E, 7F:all call)
Command 00000110 06 Machine Control Command (mcc) sub-id
00000010 02 Play (MCS)
EOX 11110111 F7 End Of Exclusive
```

#### 5.13.1.3. MMC DEFERRED PLAY

##### < Transmission >

This message is transmitted with a device number of 7F when the PLAY key is pressed.

##### < Reception >

If the AW2400 is operating as an MMC Slave, the transport will begin playback when this message is received with a matching device number or a device number of 7F.

```
STATUS 11110000 F0 System Exclusive Message
ID No. 01111111 7F Real Time System Exclusive
Device ID 0ddddddd dd Destination (00-7E, 7F:all call)
Command 00000110 06 Machine Control Command (mcc) sub-id
00000011 03 Deferred play (MCS)
EOX 11110111 F7 End Of Exclusive
```

#### 5.13.1.4. MMC FAST FORWARD

##### < Transmission >

This message is transmitted with a device number of 7F when the FF key is pressed and the Cue mode is engaged.

##### < Reception >

If the AW2400 is operating as an MMC Slave, the transport will begin fast-forward when this message is received with a matching device number or a device number of 7F.

STATUS	11110000	F0	System Exclusive Message
ID No.	01111111	7F	Real Time System Exclusive
Device ID	0ddddddd	dd	Destination (00-7E, 7F:all call)
Command	00000110	06	Machine Control Command (mcc) sub-id
	00000110	04	Fast Forward (MCS)
EOX	11110111	F7	End Of Exclusive

#### 5.13.1.5. MMC REWIND

##### < Transmission >

This message is transmitted with a device number of 7F when the REWIND key is pressed and the Review mode is engaged.

##### < Reception >

If the AW2400 is operating as an MMC Slave, the transport will begin rewind when this message is received with a matching device number or a device number of 7F.

STATUS	11110000	F0	System Exclusive Message
ID No.	01111111	7F	Real Time System Exclusive
Device ID	0ddddddd	dd	Destination (00-7E, 7F:all call)
Command	00000110	06	Machine Control Command (mcc) sub-id
	00000101	05	Rewind (MCS)
EOX	11110111	F7	End Of Exclusive

#### 5.13.1.6. MMC RECORD STROBE

##### < Reception >

This message is received if the AW2400 is operating as an MMC Slave and the device number matches or is 7F. If the transport is stopped, then recording will begin. If the transport is playing, then punch-in will occur.

STATUS	11110000	F0	System Exclusive Message
ID No.	01111111	7F	Real Time System Exclusive
Device ID	0ddddddd	dd	Destination (00-7E, 7F:all call)
Command	00000110	06	Machine Control Command (mcc) sub-id
	00000110	06	Record strobe
EOX	11110111	F7	End Of Exclusive

#### 5.13.1.7. MMC RECORD EXIT

##### < Reception >

This message is received if the AW2400 is operating as an MMC Slave and the device number matches or is 7F. If the transport is recording, then punch-out will occur.

STATUS	11110000	F0	System Exclusive Message
ID No.	01111111	7F	Real Time System Exclusive
Device ID	0ddddddd	dd	Destination (00-7E, 7F:all call)
Command	00000110	06	Machine Control Command (mcc) sub-id
	00000111	07	Record Exit
EOX	11110111	F7	End Of Exclusive

#### 5.13.1.8. MMC RESET

##### < Transmission >

This message is transmitted with a device number of 7F when song loading is finished.

##### < Reception >

This message is received if the AW2400 is operating as an MMC Slave and the device number matches or is 7F. MMC-related internal settings will be reset to the power-on state.

STATUS	11110000	F0	System Exclusive Message
ID No.	01111111	7F	Real Time System Exclusive
Device ID	0ddddddd	dd	Destination (00-7E, 7F:all call)
Command	00000110	06	Machine Control Command (mcc) sub-id
	00001101	0D	Reset
EOX	11110111	F7	End Of Exclusive

#### 5.13.1.9. MMC LOCATE (TARGET)

##### < Transmission >

This message is transmitted with a device number of 7F when a locate-related key such as MARK SEARCH/IN/OUT is pressed, a FF/REW operation is performed, when the transport returns to the auto-punch pre-roll point, or when repeating.

##### < Reception >

This message is received if the AW2400 is operating as an MMC Slave and the device number matches. The transport will locate to the time code position specified within the command data.

STATUS	11110000	F0	System Exclusive Message
ID No.	01111111	7F	Real Time System Exclusive
Device ID	0ddddddd	dd	Destination (00-7E, 7F:all call)
Command	00000110	06	Machine Control Command (mcc) sub-id
	01000100	44	Locate
	00000110	06	byte count
	00000001	01	"target" sub command
	0hhhhhhh	hh	hour (Standard Time Code)
	0mmmmmm	mm	minute
	0sssssss	ss	second
	0ffffff	ff	frame
	0sssssss	ss	sub-frame
EOX	11110111	F7	End Of Exclusive

Function...	Transmitted	Recognized	Remarks
Basic Default Channel Changed	1 - 16 1 - 16	1 - 16 1 - 16	Memorized
Mode Default Messages Altered	x x *****	1, 3 x x	Memorized
Note Number : True voice	x *****	0 - 127 x	
Velocity Note ON Note OFF	x x	x x	
After Key's Touch Ch's	x x	x x	
Pitch Bend	x	x	
Control Change	1-16 o 21-27 o 33-34 o 41-56 o 63-79 o 91-93 o 102-117 o	o o o o o o o	Assignable Cntrl Assignable Cntrl Assignable Cntrl Assignable Cntrl Assignable Cntrl Assignable Cntrl Assignable Cntrl
Prog Change : True #	o 0 - 127 *****	o 0 - 127	Assignable
System Exclusive	o	o	*1
Common : Song Pos. : Song Sel. : Tune	o x x	x x x	*2
System : Clock Real Time: Commands	o o	x x	*2 *2
Aux :All Sound Off :Reset All Cntrls :Local ON/OFF Mes- :All Notes OFF sages:Active Sense :Reset	x x x x x x	x x x x o o	
Notes: MTC quarter frame message is transmitted. MTC quarter frame message is recognized.(When MTC Slave mode) *1 :MMC *2 :When BCLK Sync mode For MIDI remote, ALL messages can be transmitted.			

Mode 1 : OMNI ON , POLY      Mode 2 : OMNI ON , MONO      o : Yes  
 Mode 3 : OMNI OFF, POLY      Mode 4 : OMNI OFF, MONO      x : No

## Specifications

### ■ General Specifications

#### Frequency Response

0 +1/-3 dB @20 Hz–20 kHz  
(MIC/LINE INPUT to STEREO OUT, GAIN: max.)

#### Total Harmonic Distortion (measured with 20 kHz LPF)

Less than 0.05 % @20 Hz to 20 kHz/+4 dBu  
(MIC/LINE INPUT to STEREO OUT, GAIN: min.)

#### Dynamic Range (measured with IHF-A)

115 dB typ. : DA Converter (STEREO OUT)  
109 dB min. : DA Converter (STEREO OUT,  
INPUT CH SEL: all off)  
110 dB typ. : AD+DA (MIC/LINE INPUT to  
STEREO OUT)  
104 dB min. : AD+DA (MIC/LINE INPUT to  
STEREO OUT, GAIN: min.)

#### AD Converter

24-bit Linear, 128-times Oversampling

#### DA Converter

24-bit Linear, 128-times Oversampling

#### Internal Processing

32-bit

#### Sampling Frequency

Internal : 44.1 kHz, 48 kHz (-6%–+6%)  
External : 44.1 kHz, 48 kHz (-10%–+6%)

#### Audio Input Section

MIC/LINE INPUT : 8 CH (XLR & phone)  
DIGITAL STEREO IN : 2 CH (coaxial stereo x 1)  
Mini-YGDAI SLOT : 16 CH

#### Audio Output Section

MONITOR OUT : 2 CH (stereo x 1)  
PHONES : 2 CH (stereo x 1)  
STEREO OUT : 2 CH (stereo x 1)  
OMNI OUT : 4 CH  
DIGITAL STEREO OUT : 2 CH (coaxial stereo x 1)  
Mini-YGDAI SLOT : 16 CH

#### Audio Insert I/O Section

INSERT I/O : 2 CH

#### Mixer Input Section (Total 48 CH)

MIC/LINE INPUT : 16 CH  
Internal Effect Return : 8 CH (stereo x 4)  
Track : 24 CH

#### Internal Effect Section

4 Built-in Multi-Effect Processors

#### Master Section (Total 16 Bus)

BUS : 4 CH (stereo x 2)  
AUX : 4 CH  
STEREO : 2 CH (stereo x 1)  
SOLO : 2 CH (stereo x 1)  
EFFECT : 4 CH

#### Built-in Hard Disk Drive

40 GB, 3.5" IDE

#### Maximum Number of Songs

100 Songs

#### Recording Resolution

16-bit/24-bit

#### Maximum Number of Simultaneous Recording/ Playback Tracks

16 Recording Tracks/24 Playback Tracks (16-bit)  
8 Recording Tracks/12 Playback Tracks (24-bit)

#### Number of Tracks

208 Tracks  
(24 Tracks + Stereo Tracks) x 8 Virtual

#### Faders

100 mm x 13 (motorized)

#### Display

320 x 240 dot LCD (with contrast control)

#### MIDI

MTC (Master/Slave), MIDI Clock (Master),  
MMC (Master/Slave), Program Change,  
Control Change

#### Memory

Scene Memory, EQ Library, Compressor Library,  
Gate Library, Effect Library, Channel Library

#### Power Consumption

85 W

#### Dimensions (W x H x D)

533 x 153 x 503 mm

#### Net Weight

11.5 kg

#### Operating Temperature

5–35 °C

#### Optional Accessories

Foot switch Yamaha FC5

## ■ Mixer Section

### ● Input/Output

#### MIC/LINE INPUT 1–8 (balanced XLR & phone)

Phantom Power Supply	: +48 ± 3 V
Input Impedance	: 3 kΩ
Nominal Input Level	: -46 dBu to + 4 dBu
Minimum Input Level	: -56 dBu
Maximum Input Level	: +24 dBu

#### INSERT I/O 1, 2 (unbalanced phone)

Input Impedance	: 10 kΩ
Nominal Input Level	: 0 dBu
Maximum Input Level	: +20 dBu
Output Impedance	: 600 Ω
Nominal Output Level	: 0 dBu
Maximum Output Level	: +20 dBu

#### STEREO OUT L, R (balanced phone)

Output Impedance	: 75 Ω
Nominal Load Impedance	: 600 Ω
Nominal Output Level	: +4 dBu
Maximum Output Level	: +24 dBu

#### MONITOR OUT L, R (balanced phone)

Output Impedance	: 75 Ω
Nominal Load Impedance	: 600 Ω
Nominal Output Level	: +4 dBu
Maximum Output Level	: +24 dBu

#### OMNI OUT 1–4 (unbalanced phone)

Output Impedance	: 150 Ω
Nominal Load Impedance	: 10 kΩ
Nominal Output Level	: +0 dBu
Maximum Output Level	: +20 dBu

#### PHONES (unbalanced TRS phone)

Load Impedance	: 8–40 Ω
Maximum Output Level	: 25 mW (8 Ω load) 75 mW (40 Ω load)

#### DIGITAL STEREO IN/OUT (coaxial)

#### Mini-YGDAI Cards

MY8-AT, MY8-TD, MY8-AE, MY4-AD, MY8-AD,  
MY4-DA, MY16-AT, MY16-TD, MY16-AE, MY8-AE96,  
MY8-AE96S, MY8-AD24, MY8-AD96, MY8-DA96,  
MY16-mLAN, Y96K

\* 0 dBu = 0.775 Vrms

## ● Digital Mixing Functions

### Input Channels (INPUT 1–16)

Phase (Normal/Reverse), Gate, Compressor,  
Attenuation, Equalizer (4-Band PEQ), Pan,  
Bus Assign (STEREO, SOLO, BUS 1–2, AUX 1–4,  
EFF 1–4)

### Track Channels (TRACK 1–24)

Attenuation, Phase (Normal/Reverse),  
Equalizer (4-Band PEQ), Compressor, Pan,  
Bus Assign (STEREO, BUS 1–2, AUX 1–4, EFF 1–4)

### Internal Effect Return Channels (EFFECT RETURN 1-4 (stereo))

Equalizer (4-Band PEQ), Pan,  
Bus Assign (STEREO, AUX 1–4)

### Master Channels

STEREO L, R	: Attenuation, Equalizer (4-Band PEQ), Compressor, Balance
BUS 1 L/R, 2 L/R	: Attenuation, Equalizer (4-Band PEQ), Compressor, Balance
AUX 1–4	: Attenuation, Equalizer (4-Band PEQ), Compressor, Balance
EFF 1–4	: Compressor

## ■ Recorder Section

### Overview

Recording Resolution	: 16-bit/24-bit
Sampling Frequency	: 44.1 kHz/48 kHz

### Edit Functions

Song Edit	: OPTIMIZE, DELETE, COPY, IMPORT
Track Edit	: ERASE, DELETE, INSERT, COPY, MOVE, EXCHANGE, TIME COMP/EXPAND, PITCH CHANGE, IMPORT CD AUDIO, IMPORT CD WAV, IMPORT USB WAV, IMPORT TRACK, EXPORT

### Other Functions

Locate point/Marker	
Locate	: RTZ, A/B, LAST REC IN/OUT, Quick Locate 1–9
MARK	: 1–99
Punch-In/Out	: Manual, Auto
Pitch Fix	

### CD-RW Drive

Data Backup, Audio CD Burning and Playback,  
Audio CD Import, WAV File Import

## ■ External Control

MIDI IN	: 5-pin DIN
MIDI OUT/THRU	: 5-pin DIN
FOOT SW	: phone
USB	: USB 2.0

**Dimensions**

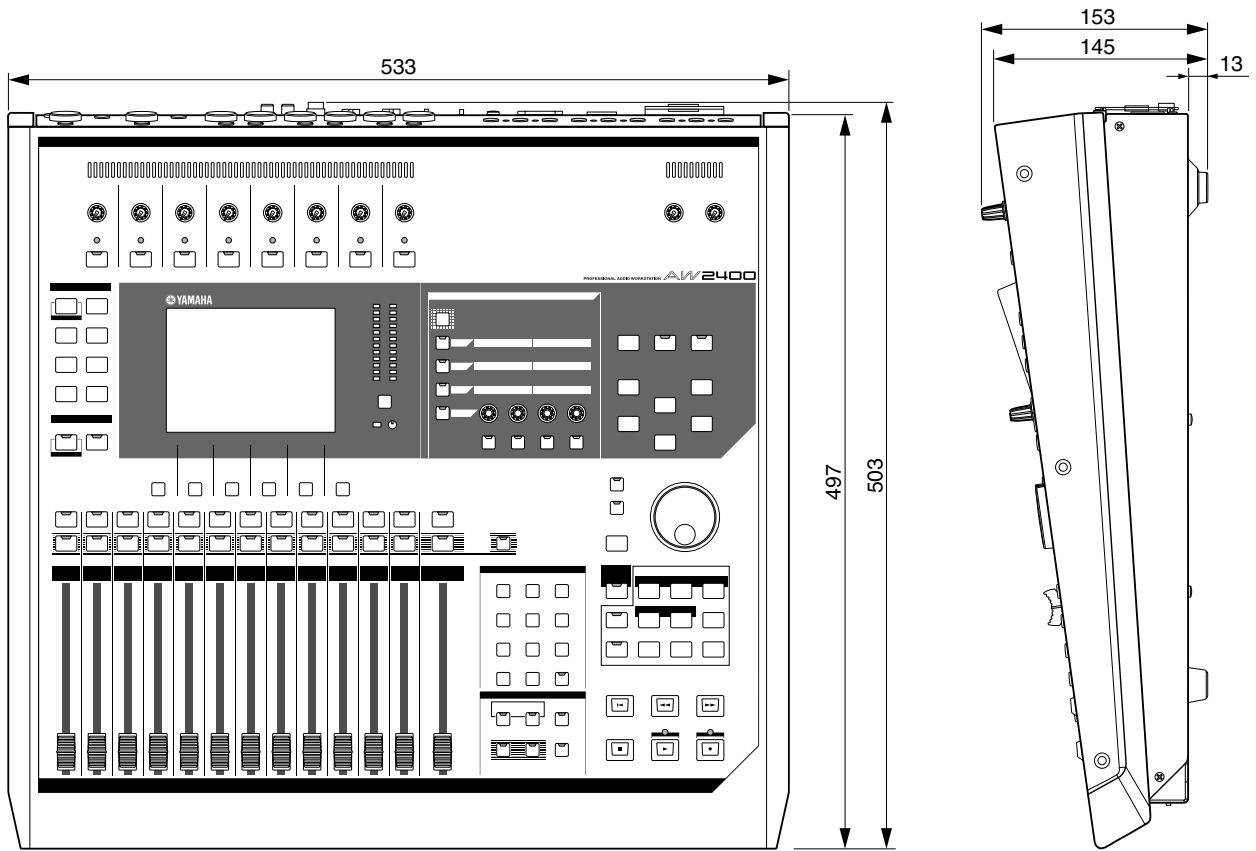

Unit: mm

\* Specifications and descriptions in this owner’s manual are for information purposes only. Yamaha Corp. reserves the right to change or modify products or specifications at any time without prior notice. Since specifications, equipment or options may not be the same in every locale, please check with your Yamaha dealer.

For European models  
 Purchaser/User Information specified in EN55103-1 and EN55103-2.  
 Inrush Current: 35A  
 Conforms to Environments: E1, E2, E3 and E4

## Index

- A**
- A/B keys ..... 27, 89
  - A/B points ..... 88
  - A-B repeat ..... 93
  - ABS ..... 174
  - AC IN connector ..... 28
  - Accessing a screen/page ..... 31
  - Additional Function buttons ..... 31
  - Adjusting the input level ..... 39
  - AMP ..... 95
  - Assigning input signals to tracks
    - Direct recording ..... 51, 99
    - Mixed recording ..... 54, 102
  - Audio CD ..... 213
    - Basic settings ..... 215
    - Creating ..... 213
    - Disc At Once ..... 214, 218
    - Erasing ..... 221
    - Finalizing ..... 220
    - Playing ..... 222
    - Track At Once ..... 214, 217
    - Writing methods ..... 214
  - Audio tracks ..... 128
  - AUTO DISPLAY button ..... 211
  - AUTO PUNCH key ..... 27, 70
  - Auto punch-in/out ..... 70
  - AUTO SAVE button ..... 211
  - Automix ..... 181
  - AUTOMIX key ..... 24
  - Automix Library ..... 190
  - AUTOMIX screen
    - Automix page ..... 181
    - Edit page ..... 186
    - Event List page ..... 188
    - Library page ..... 190
  - AUTOREC button ..... 182
  - AUX ..... 111
  - AUX key ..... 24
  - AUX screen
    - Input/RTN page ..... 112
    - Track page ..... 112
  - AUX send level ..... 112
  - AW2816 ..... 177
- B**
- Backing up ..... 177
  - Bit depth ..... 165
  - Block diagram ..... 284
  - Bounce ..... 74, 79
  - BURST NOISE button ..... 209
  - BYPASS ..... 121
- C**
- CANCEL key ..... 27
  - Card ..... 13, 104, 223
  - Cascade connection ..... 226
  - CD key ..... 21
  - CD Play function ..... 222
  - CD screen
    - Play page ..... 222
    - Setting page ..... 215
    - Write page ..... 217
  - CD/DAT DIGITAL REC button ..... 210
  - CD/ST TR PLAY MODE MUTE/MIX button ..... 211
  - CD-RW drive ..... 12, 29
    - Access indicator ..... 29
    - Basic settings ..... 215
    - Eject hole ..... 29
    - Eject switch ..... 29
    - Handling ..... 12
    - Handling CD-R/RW media ..... 6
    - Removing in an emergency ..... 12
    - Writing methods ..... 214
  - CH VIEW screen
    - Library page ..... 108
    - View page ..... 105
  - Channel Library ..... 108
  - Cluster size ..... 212
  - COMP (Compressor) ..... 153, 240
  - Compander ..... 153, 241
  - COMPARE button ..... 215
  - Compressor ..... 61, 152
  - Compressor Parameter list ..... 243
  - Connection ..... 37
  - Control change ..... 194
  - CONTROL CHANGE MODE ..... 195
  - Copyright Notice ..... 7
- D**
- DATA/JOG dial ..... 25
  - Demo song ..... 41
  - DETECT ..... 125
  - Digital input signal ..... 227
  - Digital input/output ..... 223
  - DIGITAL OUT COPYRIGHT button ..... 210
  - DIGITAL STEREO IN/OUT connectors ..... 29, 104
  - Dimensions ..... 279
  - DIO key ..... 21
  - DIO screen
    - Plug-in page ..... 228
    - Setting page ..... 223
    - Status page ..... 227
  - DIRECT OUT ..... 100
  - DIRECT OUT EXTRACT POSITION ..... 211
  - Direct recording ..... 49, 99
  - Disc At Once ..... 214, 218
  - Display message list ..... 263
  - DITHER ..... 75
  - DUCKING ..... 151, 242
  - DYN key ..... 24
  - Dynamics ..... 151
  - Dynamics Parameters ..... 240
  - DYNAMICS screen
    - Comp Edit page ..... 152
    - Comp Lib. page ..... 155
    - Gate Edit page ..... 151
    - Gate Lib. page ..... 155
- E**
- EDIT key ..... 21
  - EDIT screen
    - Edit page ..... 136
    - Mark Adj. page ..... 91
    - Tempo Map page ..... 175
  - Editing a value in the display ..... 31
  - Editing command ..... 138
    - COPY ..... 139
    - DELETE ..... 138
    - ERASE ..... 138
    - EXCHANGE ..... 141
    - EXPORT ..... 233



- IMPORT CD AUDIO..... 143  
 IMPORT CD WAV..... 143  
 IMPORT TRACK..... 145  
 IMPORT USB WAV ..... 234  
 INSERT ..... 138  
 MOVE ..... 140  
 PITCH ..... 142  
 TIME COMP..... 141  
 EFFECT key ..... 24  
 Effect Library ..... 116, 122  
 EFFECT screen  
   FX Edit page ..... 121  
   FX Input page ..... 117  
   FX Lib. page..... 122  
   FX Track page ..... 117  
 Effects ..... 115  
   BYPASS..... 121  
   Insert ..... 115, 119  
   INSERT EFF ..... 107, 119  
   MIX BALANCE..... 121  
   Send and Return..... 115, 117  
   USED AS ..... 121  
 Effects Parameters ..... 245  
 EMPHASIS ..... 227  
 ENTER key..... 25  
 Entering text ..... 32  
 EQ ..... 60, 149  
 EQ Library ..... 154  
 EQ Parameter list ..... 238  
 EXPAND (Expander) ..... 153, 241  
 External effects..... 113, 120  
 External MIDI devices ..... 200
- F**
- F1-F4 keys ..... 22, 31  
 Fader Group ..... 82  
 Fader Start ..... 134  
 Faders ..... 23  
 Features ..... 15  
 FF key ..... 27  
 FINALIZE button..... 220  
 Finalizing ..... 220  
 FOOT SW jack ..... 29  
 FORMANT..... 125  
 Front panel ..... 29
- G**
- GAIN knobs ..... 21  
 GATE ..... 151, 242  
 Gate Library ..... 154  
 Gate Parameter list..... 243  
 Ground screw ..... 28  
 GROUP..... 134
- H**
- Hard disk..... 212
- I**
- IN 1-8 key ..... 26  
 IN 9-16 key ..... 26  
 IN/OUT keys ..... 27, 70, 89  
 In/Out points ..... 88  
 Included CD-ROM ..... 266  
 INITIALIZE button ..... 106  
 Initializing ..... 212  
 INPUT CH MUTE/MIX button .... 222  
 INPUT SEL keys..... 21  
 INSERT EFF ..... 107, 119  
 INSERT I/O jacks..... 28  
 Inserting effect ..... 115, 119  
 Internal Effects..... 115  
 Internal hard disk ..... 212
- J**
- JOG ON key ..... 25, 94
- K**
- KEYIN SOURCE..... 151
- L**
- LAST SOLO ..... 84  
 LATCH button ..... 206  
 Layer section ..... 26, 33  
 LEARN button..... 207  
 Level meters ..... 97  
 Library  
   Automix Library ..... 190  
   Channel Library ..... 108  
   Effect Library ..... 116, 122  
   EQ Library ..... 154  
   Gate Library ..... 154  
   Mastering Library ..... 75  
 LOCATE keys ..... 25, 32, 88, 89  
 Locate points/Markers ..... 88  
   A/B points ..... 88  
   Adjusting the position..... 91, 92  
   Erasing..... 93  
   In/Out points ..... 88  
   Locate points ..... 88  
   LOCATOR button ..... 91  
   MARKER button ..... 91  
   Markers..... 90  
   Quick Locator points ..... 88  
   Relative zero point ..... 88  
   Start/End points ..... 88  
 Locate section ..... 27
- M**
- Manual punch-in/out..... 69  
 MARK key ..... 27, 90  
 MARK SEARCH keys ..... 27, 90  
 Markers ..... 90  
 MASTER key..... 26  
 MASTER TUNING ..... 126  
 Mastering library..... 75  
 Mastering library list ..... 237  
 MASTERING LIBRARY  
   popup window ..... 76  
 METER key ..... 22  
 METER screen..... 97  
   Input/RTN page ..... 97  
   Master page..... 98  
   Output page ..... 98  
   Track page..... 97  
 Meters ..... 97  
 Metronome ..... 44, 62  
 MIC/LINE INPUT jacks..... 28  
 MIDI..... 193  
   Basic settings..... 194  
   CHANNEL..... 194  
   CONTROL CHANGE MODE .. 195  
   DEVICE NO. .... 199  
   MMC ..... 198, 200  
   MTC ..... 199, 200  
   OFFSET..... 199  
   PORT ..... 194  
   SYNC AVERAGE ..... 199  
   SYNC OUT ..... 199  
   THRU..... 198  
 MIDI Clock..... 202

MIDI Data Format ..... 272  
 MIDI Implementation Chart ..... 276  
 MIDI IN connector ..... 29  
 MIDI key ..... 21  
 MIDI OUT/THRU connector ..... 29  
 MIDI remote ..... 204  
 MIDI screen  
   Setting 1 page ..... 194  
   Setting 2 page ..... 198  
 MIX BALANCE ..... 121  
 Mix parameters ..... 105  
 MIX SOLO ..... 84  
 Mixdown ..... 73, 75  
 MIXDOWN SOLO ..... 84  
 Mixed recording ..... 50, 102  
 Mixing layers ..... 33  
 MMC ..... 198, 200  
 MONITOR key ..... 21  
 MONITOR knob ..... 24  
 MONITOR OUT jacks ..... 28  
 MONITOR screen  
   Fader Grp. page ..... 82  
   Mute Grp. page ..... 83  
   Pair page ..... 58  
   Solo page ..... 84  
 MTC ..... 199, 200  
 MULTI CONNECTION ..... 100  
 MUTE CLEAR ..... 100, 102  
 Mute Group ..... 83

## N

Nudge function ..... 94  
 NUDGE PLAY MODE ..... 210  
 NUDGE TIME ..... 210  
 NUM.LOCK key ..... 87

## O

OFFSET ..... 199  
 OMNI OUT jacks ..... 28, 104  
 ON keys ..... 23  
 Optimizing ..... 172  
 Optional card ..... 13, 104, 223  
 Output signal patching ..... 104  
 Overdubbing ..... 65  
 OVERWRITE ..... 182

## P

Pairing ..... 58  
 Pan ..... 147  
 PAN/EQ key ..... 24  
 PAN/EQ screen  
   EQ Lib. page ..... 154  
   EQ/Att. page ..... 149  
   Input/RTN page ..... 147  
   Track page ..... 147  
 PATCH key ..... 21  
 PATCH screen ..... 104  
 Patching ..... 99  
 PEAK HOLD button ..... 98  
 PEAK indicators ..... 21  
 PHANTOM +48V switches ..... 29  
 PHONES jack ..... 28  
 PHONES knob ..... 24  
 Ping-pong recording ..... 74, 79  
 PINK NOISE button ..... 209  
 Pitch Fix ..... 124  
 PLAY key ..... 27  
 Plug-in card ..... 228  
 Postroll time ..... 70, 211  
 POWER switch ..... 28, 38  
 Preroll time ..... 70, 210  
 Program change ..... 194, 201  
 Punch-in/out ..... 69

## Q

Quick Locator points ..... 88

## R

RATE ..... 125  
 Rear panel ..... 28  
 REC key ..... 27  
 RECALL CONFIRMATION  
 button ..... 211  
 Recall Safe ..... 162  
 RECORD key ..... 21  
 RECORD screen  
   Bounce page ..... 79  
   Direct page ..... 51, 99  
   Mixdown page ..... 75  
   Mixed page ..... 54, 102  
   PITCH FIX ..... 124  
 RECORDING SOLO ..... 84

RELATIVE ..... 174  
 Relative zero point ..... 88  
 Remote file ..... 268  
 REMOTE key ..... 26  
 REMOTE screen ..... 205  
 REPEAT key ..... 27, 93  
 Restoring ..... 178  
 Return time ..... 185  
 REW key ..... 27  
 RTZ key ..... 27, 89

## S

SCALE ..... 95, 125  
 SCENE key ..... 24  
 Scene Memory ..... 159  
 SCENE screen  
   Library page ..... 159  
   PGM Assign page ..... 201  
   RCL Safe page ..... 162  
   Sort page ..... 163  
 SEL keys ..... 23  
 Selected Channel knobs ..... 24  
 Selected Channel section ..... 24, 33  
 Send and Return ..... 115, 117  
 Sequencer ..... 202  
 SET key ..... 27, 89  
 SHIFT key ..... 22, 31  
 Shut down ..... 38  
 SHUTDOWN button ..... 38  
 Slot ..... 29  
 Solo ..... 84  
 SOLO key ..... 23  
 SONG key ..... 21  
 SONG screen  
   Backup page ..... 177  
   Restore page ..... 178  
   Setting page ..... 174  
   Song List page ..... 167  
 Songs ..... 165  
   AW2816 ..... 177  
   Backing up ..... 177  
   Bit depth ..... 165  
   Copying ..... 171  
   Deleting ..... 171  
   Editing settings ..... 174  
   Editing the song name ..... 169  
   Folder Organization ..... 166  
   Importing data ..... 173

- Loading ..... 170
  - New song ..... 47, 168
  - Optimizing ..... 172
  - Protection ..... 172
  - Restoring ..... 178
  - Saving ..... 57, 170
  - Tempo map ..... 175
  - Sound Clip ..... 43
  - SOUND CLIP key ..... 27
  - SOUND CLIP screen ..... 44
  - SOUND CLIP TIME ..... 47
  - Specifications ..... 277
  - Start/End points ..... 88
  - STEREO fader ..... 23
  - STEREO ON key ..... 23
  - STEREO OUT jacks ..... 28
  - STEREO SEL key ..... 23
  - Stereo track ..... 130
  - STOP key ..... 27
  - STORE CONFIRMATION  
button ..... 211
  - Switching a button on/off ..... 31
  - SYNC AVERAGE ..... 199
  - SYNC CAUTION  
DIGITAL ST IN button ..... 211
  - SYNC CAUTION  
SLOT IN button ..... 211
  - SYNC OUT ..... 199
  - Synchronizing ..... 200
- T**
- 
- Tempo Map ..... 175
  - Test tone oscillator ..... 209
  - THRU ..... 198
  - Tone generator module ..... 207
  - Top panel ..... 20
  - TRACK 1-12 key ..... 26
  - TRACK 13-24 key ..... 26
  - Track At Once ..... 214, 217
  - Track editing ..... 135
    - Basic procedure ..... 136
    - Editing command ..... 138
  - TRACK key ..... 21
  - Track recording ..... 47
    - Direct recording ..... 49, 51, 99
    - Metronome ..... 62
    - Mixed recording ..... 50, 54, 102
  - TRACK screen
    - Stereo TR page ..... 131
    - Trigger page ..... 134
    - View page ..... 128
    - Virtual TR page ..... 63, 129
  - Transport section ..... 27, 87
  - Trigger track ..... 133
  - Troubleshooting ..... 258
  - Turning the power on/off ..... 38
- U**
- 
- UNDERRUN PROTECT button ..... 215
  - UNDO LIST popup window ..... 64
  - UNDO/REDO key ..... 25, 64
  - UNLATCH button ..... 206
  - USB connector ..... 29, 229
  - USB key ..... 24
  - USB MIDI driver ..... 266
  - USB screen ..... 231
  - USB Storage mode ..... 229, 230
  - USED AS ..... 121
  - User-defined ..... 206
  - Utility functions ..... 209
  - UTILITY key ..... 21
  - UTILITY screen
    - Format page ..... 212
    - Oscillator page ..... 209
    - Preference page ..... 210
- V**
- 
- VARI ..... 226
  - Vari-pitch ..... 226
  - VIEW key ..... 24
  - Viewing the display ..... 30
  - Virtual tracks ..... 63
- W**
- 
- WAV files ..... 233, 234
  - WAVE DISPLAY popup window .. 95
  - Waveform ..... 95
  - Wordclock ..... 223
  - WORDCLOCK SOURCE ..... 223

# Block diagram

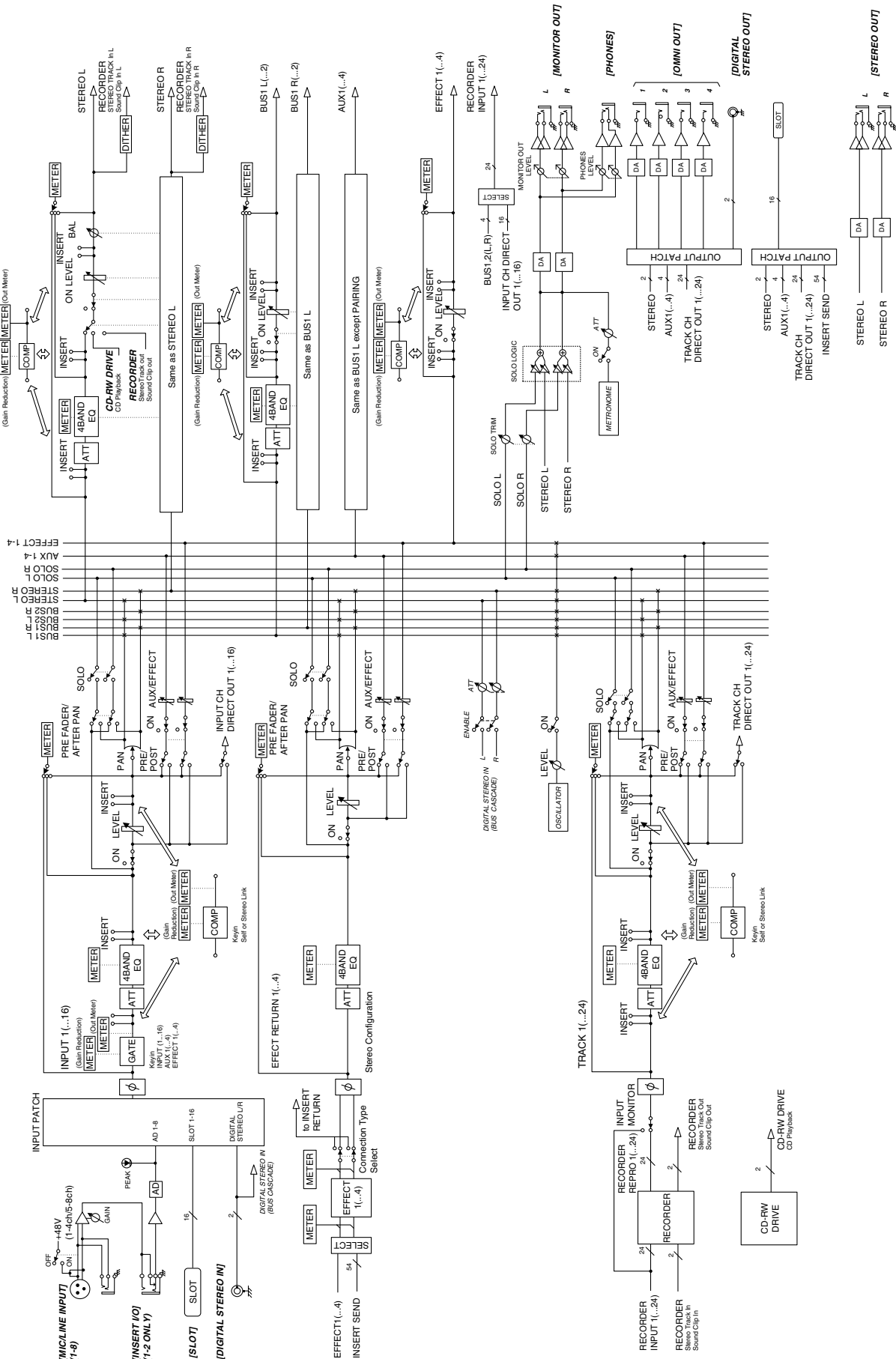

## ATTENTION SOFTWARE LICENSE AGREEMENT

PLEASE READ THIS SOFTWARE LICENSE AGREEMENT ("AGREEMENT") CAREFULLY BEFORE USING THIS SOFTWARE. YOU ARE ONLY PERMITTED TO USE THIS SOFTWARE PURSUANT TO THE TERMS AND CONDITIONS OF THIS AGREEMENT. THIS AGREEMENT IS BETWEEN YOU (AS AN INDIVIDUAL OR LEGAL ENTITY) AND YAMAHA CORPORATION ("YAMAHA").

BY BREAKING THE SEAL OF THIS PACKAGE YOU ARE AGREEING TO BE BOUND BY THE TERMS OF THIS LICENSE. IF YOU DO NOT AGREE WITH THE TERMS, DO NOT INSTALL, COPY, OR OTHERWISE USE THIS SOFTWARE.

### 1. GRANT OF LICENSE AND COPYRIGHT

Yamaha hereby grants you the right to use one copy of the software program(s) and data ("SOFTWARE") accompanying this Agreement. The term SOFTWARE shall encompass any updates to the accompanying software and data. The SOFTWARE is owned by Yamaha and/or Yamaha's licensor(s), and is protected by relevant copyright laws and all applicable treaty provisions. While you are entitled to claim ownership of the data created with the use of SOFTWARE, the SOFTWARE will continue to be protected under relevant copyrights.

- **You may** use the SOFTWARE on a **single computer**.
- **You may** make one copy of the SOFTWARE in machine-readable form for backup purposes only, if the SOFTWARE is on media where such backup copy is permitted. On the backup copy, you must reproduce Yamaha's copyright notice and any other proprietary legends that were on the original copy of the SOFTWARE.
- **You may** permanently transfer to a third party all your rights in the SOFTWARE, provided that you do not retain any copies and the recipient reads and agrees to the terms of this Agreement.

### 2. RESTRICTIONS

- **You may not** engage in reverse engineering, disassembly, decompilation or otherwise deriving a source code form of the SOFTWARE by any method whatsoever.
- **You may not** reproduce, modify, change, rent, lease, or distribute the SOFTWARE in whole or in part, or create derivative works of the SOFTWARE.
- **You may not** electronically transmit the SOFTWARE from one computer to another or share the SOFTWARE in a network with other computers.
- **You may not** use the SOFTWARE to distribute illegal data or data that violates public policy.
- **You may not** initiate services based on the use of the SOFTWARE without permission by Yamaha Corporation.

Copyrighted data, including but not limited to MIDI data for songs, obtained by means of the SOFTWARE, are subject to the following restrictions which you must observe.

- Data received by means of the SOFTWARE may not be used for any commercial purposes without permission of the copyright owner.
- Data received by means of the SOFTWARE may not be duplicated, transferred, or distributed, or played back or performed for listeners in public without permission of the copyright owner.
- The encryption of data received by means of the SOFTWARE may not be removed nor may the electronic watermark be modified without permission of the copyright owner.

### 3. TERMINATION

This Agreement becomes effective on the day that you receive the SOFTWARE and remains effective until terminated. If any copyright law or provisions of this Agreement is violated, the Agreement shall terminate automatically and immediately without notice from Yamaha. Upon such termination, you must immediately destroy the licensed SOFTWARE, any accompanying written documents and all copies thereof.

### 4. LIMITED WARRANTY ON MEDIA

As to SOFTWARE sold on tangible media, Yamaha warrants that the tangible media on which the SOFTWARE is recorded will be free from defects in materials and workmanship under normal use for a period of fourteen (14) days from the date of receipt, as evidenced by a copy of the receipt. Yamaha's entire liability and your exclusive remedy will be replacement of the defective media if it is returned to Yamaha or an

authorized Yamaha dealer within fourteen days with a copy of the receipt. Yamaha is not responsible for replacing media damaged by accident, abuse or misapplication. TO THE FULLEST EXTENT PERMITTED BY LAW, YAMAHA EXPRESSLY DISCLAIMS ANY IMPLIED WARRANTIES ON THE TANGIBLE MEDIA, INCLUDING THE IMPLIED WARRANTIES OF MERCHANTABILITY AND FITNESS FOR A PARTICULAR PURPOSE.

### 5. DISCLAIMER OF WARRANTY ON SOFTWARE

You expressly acknowledge and agree that use of the SOFTWARE is at your sole risk. The SOFTWARE and related documentation are provided "AS IS" and without warranty of any kind. NOTWITHSTANDING ANY OTHER PROVISION OF THIS AGREEMENT, YAMAHA EXPRESSLY DISCLAIMS ALL WARRANTIES AS TO THE SOFTWARE, EXPRESS, AND IMPLIED, INCLUDING BUT NOT LIMITED TO THE IMPLIED WARRANTIES OF MERCHANTABILITY, FITNESS FOR A PARTICULAR PURPOSE AND NON-INFRINGEMENT OF THIRD PARTY RIGHTS. SPECIFICALLY, BUT WITHOUT LIMITING THE FOREGOING, YAMAHA DOES NOT WARRANT THAT THE SOFTWARE WILL MEET YOUR REQUIREMENTS, THAT THE OPERATION OF THE SOFTWARE WILL BE UNINTERRUPTED OR ERROR-FREE, OR THAT DEFECTS IN THE SOFTWARE WILL BE CORRECTED.

### 6. LIMITATION OF LIABILITY

YAMAHA'S ENTIRE OBLIGATION HEREUNDER SHALL BE TO PERMIT USE OF THE SOFTWARE UNDER THE TERMS HEREOF. IN NO EVENT SHALL YAMAHA BE LIABLE TO YOU OR ANY OTHER PERSON FOR ANY DAMAGES, INCLUDING, WITHOUT LIMITATION, ANY DIRECT, INDIRECT, INCIDENTAL OR CONSEQUENTIAL DAMAGES, EXPENSES, LOST PROFITS, LOST DATA OR OTHER DAMAGES ARISING OUT OF THE USE, MISUSE OR INABILITY TO USE THE SOFTWARE, EVEN IF YAMAHA OR AN AUTHORIZED DEALER HAS BEEN ADVISED OF THE POSSIBILITY OF SUCH DAMAGES. In no event shall Yamaha's total liability to you for all damages, losses and causes of action (whether in contract, tort or otherwise) exceed the amount paid for the SOFTWARE.

### 7. THIRD PARTY SOFTWARE

Third party software and data ("THIRD PARTY SOFTWARE") may be attached to the SOFTWARE. If, in the written materials or the electronic data accompanying the Software, Yamaha identifies any software and data as THIRD PARTY SOFTWARE, you acknowledge and agree that you must abide by the provisions of any Agreement provided with the THIRD PARTY SOFTWARE and that the party providing the THIRD PARTY SOFTWARE is responsible for any warranty or liability related to or arising from the THIRD PARTY SOFTWARE. Yamaha is not responsible in any way for the THIRD PARTY SOFTWARE or your use thereof.

- Yamaha provides no express warranties as to the THIRD PARTY SOFTWARE. IN ADDITION, YAMAHA EXPRESSLY DISCLAIMS ALL IMPLIED WARRANTIES, INCLUDING BUT NOT LIMITED TO THE IMPLIED WARRANTIES OF MERCHANTABILITY AND FITNESS FOR A PARTICULAR PURPOSE, as to the THIRD PARTY SOFTWARE.
- Yamaha shall not provide you with any service or maintenance as to the THIRD PARTY SOFTWARE.
- Yamaha is not liable to you or any other person for any damages, including, without limitation, any direct, indirect, incidental or consequential damages, expenses, lost profits, lost data or other damages arising out of the use, misuse or inability to use the THIRD PARTY SOFTWARE.

### 8. GENERAL

This Agreement shall be interpreted according to and governed by Japanese law without reference to principles of conflict of laws. Any dispute or procedure shall be heard before the Tokyo District Court in Japan. If for any reason a court of competent jurisdiction finds any portion of this Agreement to be unenforceable, the remainder of this Agreement shall continue in full force and effect.

### 9. COMPLETE AGREEMENT

This Agreement constitutes the entire agreement between the parties with respect to use of the SOFTWARE and any accompanying written materials and supersedes all prior or contemporaneous understandings or agreements, written or oral, regarding the subject matter of this Agreement. No amendment or revision of this Agreement will be binding unless in writing and signed by a fully authorized representative of Yamaha.

**MEMO** \_\_\_\_\_

For details of products, please contact your nearest Yamaha representative or the authorized distributor listed below.

Pour plus de détails sur les produits, veuillez-vous adresser à Yamaha ou au distributeur le plus proche de vous figurant dans la liste suivante.

Die Einzelheiten zu Produkten sind bei Ihrer unten aufgeführten Niederlassung und bei Yamaha Vertragshändlern in den jeweiligen Bestimmungsländern erhältlich.

Para detalles sobre productos, contacte su tienda Yamaha más cercana o el distribuidor autorizado que se lista debajo.

## NORTH AMERICA

### CANADA

**Yamaha Canada Music Ltd.**  
135 Milner Avenue, Scarborough, Ontario,  
M1S 3R1, Canada  
Tel: 416-298-1311

### U.S.A.

**Yamaha Corporation of America**  
6600 Orangethorpe Ave., Buena Park,  
Calif. 90620, U.S.A.  
Tel: 714-522-9011

## CENTRAL & SOUTH AMERICA

### MEXICO

**Yamaha de México S.A. de C.V.**  
Calz. Javier Rojo Gómez #1149,  
Col. Guadalupe del Moral  
C.P. 09300, México, D.F., México  
Tel: 55-5804-0600

### BRAZIL

**Yamaha Musical do Brasil Ltda.**  
Rua Joaquim Floriano, 913 - 4º andar, Itaim  
Bibi, CEP 04534-013 Sao Paulo, SP. BRAZIL  
Tel: 011-3704-1377

### ARGENTINA

**Yamaha Music Latin America, S.A.**  
**Sucursal de Argentina**  
Viamonte 1145 Piso 2-B 1053,  
Buenos Aires, Argentina  
Tel: 1-4371-7021

### PANAMA AND OTHER LATIN AMERICAN COUNTRIES/ CARIBBEAN COUNTRIES

**Yamaha Music Latin America, S.A.**  
Torre Banco General, Piso 7, Urbanización  
Marbella, Calle 47 y Aquilino de la Guardia,  
Ciudad de Panamá, Panamá  
Tel: +507-269-5311

## EUROPE

### THE UNITED KINGDOM

**Yamaha Music U.K. Ltd.**  
Sherbourne Drive, Tilbrook, Milton Keynes,  
MK7 8BL, England  
Tel: 01908-366700

### GERMANY

**Yamaha Music Central Europe GmbH**  
Siemensstraße 22-34, 25462 Rellingen,  
Germany  
Tel: 04101-3030

### SWITZERLAND/LIECHTENSTEIN

**Yamaha Music Central Europe GmbH,**  
**Branch Switzerland**  
Seefeldstrasse 94, 8008 Zürich, Switzerland  
Tel: 01-383 3990

### AUSTRIA

**Yamaha Music Central Europe GmbH,**  
**Branch Austria**  
Schleiergasse 20, A-1100 Wien, Austria  
Tel: 01-60203900

### CZECH REPUBLIC/SLOVAKIA/ HUNGARY/SLOVENIA

**Yamaha Music Central Europe GmbH,**  
**Branch Austria, CEE Department**  
Schleiergasse 20, A-1100 Wien, Austria  
Tel: 01-602039025

### POLAND

**Yamaha Music Central Europe GmbH**  
**Sp.z o.o. Oddział w Polsce**  
ul. 17 Stycznia 56, PL-02-146 Warszawa,  
Poland  
Tel: 022-868-07-57

### THE NETHERLANDS/ BELGIUM/LUXEMBOURG

**Yamaha Music Central Europe GmbH,**  
**Branch Benelux**  
Clarissenhof 5-b, 4133 AB Vianen,  
The Netherlands  
Tel: 0347-358 040

### FRANCE

**Yamaha Musique France**  
BP 70-77312 Marne-la-Vallée Cedex 2, France  
Tel: 01-64-61-4000

### ITALY

**Yamaha Musica Italia S.P.A.**  
**Combo Division**  
Viale Italia 88, 20020 Lainate (Milano), Italy  
Tel: 02-935-7711

### SPAIN/PORTUGAL

**Yamaha Música Ibérica, S.A.**  
Ctra. de la Coruna km. 17, 200, 28230  
Las Rozas (Madrid), Spain  
Tel: 91-639-8888

### SWEDEN

**Yamaha Scandinavia AB**  
J. A. Wettergrens Gata 1  
Box 30053  
S-400 43 Göteborg, Sweden  
Tel: 031 89 34 00

### DENMARK

**YS Copenhagen Liaison Office**  
Generatorvej 6A  
DK-2730 Herlev, Denmark  
Tel: 44 92 49 00

### NORWAY

**Norsk filial av Yamaha Scandinavia AB**  
Grini Næringspark 1  
N-1345 Østerås, Norway  
Tel: 67 16 77 70

### OTHER EUROPEAN COUNTRIES

**Yamaha Music Central Europe GmbH**  
Siemensstraße 22-34, 25462 Rellingen,  
Germany  
Tel: +49-4101-3030

## AFRICA

**Yamaha Corporation,**  
**Asia-Pacific Music Marketing Group**  
Nakazawa-cho 10-1, Naka-ku, Hamamatsu,  
Japan 430-8650  
Tel: +81-53-460-2313

## MIDDLE EAST

### TURKEY/CYPRUS

**Yamaha Music Central Europe GmbH**  
Siemensstraße 22-34, 25462 Rellingen,  
Germany  
Tel: 04101-3030

### OTHER COUNTRIES

**Yamaha Music Gulf FZE**  
LOB 16-513, P.O.Box 17328, Jubel Ali,  
Dubai, United Arab Emirates  
Tel: +971-4-881-5868

## ASIA

### THE PEOPLE'S REPUBLIC OF CHINA

**Yamaha Music & Electronics (China)**  
**Co.,Ltd.**  
25/F., United Plaza, 1468 Nanjing Road  
(West), Jingan, Shanghai, China  
Tel: 021-6247-2211

### INDONESIA

**PT. Yamaha Music Indonesia (Distributor)**  
**PT. Nusantik**  
Gedung Yamaha Music Center, Jalan Jend.  
Gatot Subroto Kav. 4, Jakarta 12930, Indonesia  
Tel: 21-520-2577

### KOREA

**Yamaha Music Korea Ltd.**  
8F, 9F, Dongsung Bldg. 158-9 Samsung-Dong,  
Kangnam-Gu, Seoul, Korea  
Tel: 080-004-0022

### MALAYSIA

**Yamaha Music Malaysia, Sdn., Bhd.**  
Lot 8, Jalan Perbandaran, 47301 Kelana Jaya,  
Petaling Jaya, Selangor, Malaysia  
Tel: 3-78030900

### SINGAPORE

**Yamaha Music Asia Pte., Ltd.**  
#03-11 A-Z Building  
140 Paya Lebar Road, Singapore 409015  
Tel: 747-4374

### TAIWAN

**Yamaha KHS Music Co., Ltd.**  
3F, #6, Sec.2, Nan Jing E. Rd. Taipei.  
Taiwan 104, R.O.C.  
Tel: 02-2511-8688

### THAILAND

**Siam Music Yamaha Co., Ltd.**  
891/1 Siam Motors Building, 15-16 floor  
Rama 1 road, Wangmai, Pathumwan  
Bangkok 10330, Thailand  
Tel: 02-215-2626

### OTHER ASIAN COUNTRIES

**Yamaha Corporation,**  
**Asia-Pacific Music Marketing Group**  
Nakazawa-cho 10-1, Naka-ku, Hamamatsu,  
Japan 430-8650  
Tel: +81-53-460-2317

## OCEANIA

### AUSTRALIA

**Yamaha Music Australia Pty. Ltd.**  
Level 1, 99 Queensbridge Street, Southbank,  
Victoria 3006, Australia  
Tel: 3-9693-5111

### COUNTRIES AND TRUST TERRITORIES IN PACIFIC OCEAN

**Yamaha Corporation,**  
**Asia-Pacific Music Marketing Group**  
Nakazawa-cho 10-1, Naka-ku, Hamamatsu,  
Japan 430-8650  
Tel: +81-53-460-2313

**HEAD OFFICE** Yamaha Corporation, Pro Audio & Digital Musical Instrument Division  
Nakazawa-cho 10-1, Naka-ku, Hamamatsu, Japan 430-8650  
Tel: +81-53-460-2441



Yamaha Web Site (English only)  
<http://www.yamahasyth.com/>

Yamaha Manual Library  
<http://www.yamaha.co.jp/manual/>

U.R.G., Pro Audio & Digital Musical Instrument Division, Yamaha Corporation  
© 2005 Yamaha Corporation

WE25170 710POCPx.x-02B0  
Printed in Japan