



# YAMAHA

# CDR-S1000

*Compact Disc Recorder*

*Lecteur/Enregistreur CD*

COMPACT  
disc  
DIGITAL AUDIO  
Recordable

COMPACT  
disc  
DIGITAL AUDIO  
ReWritable

COMPACT  
disc  
DIGITAL AUDIO

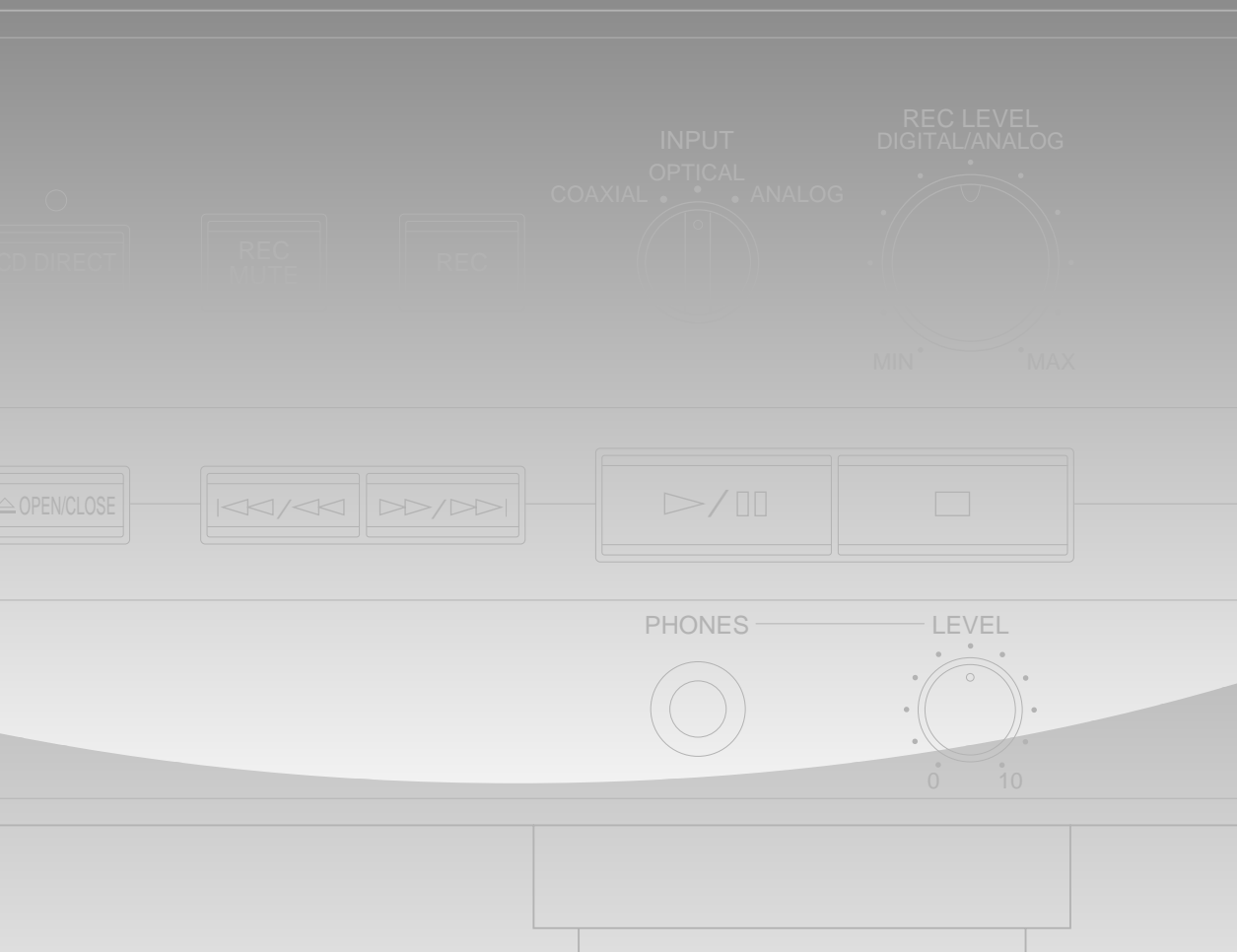

**OWNER'S MANUAL  
MODE D'EMPLOI**

# SAFETY INSTRUCTIONS

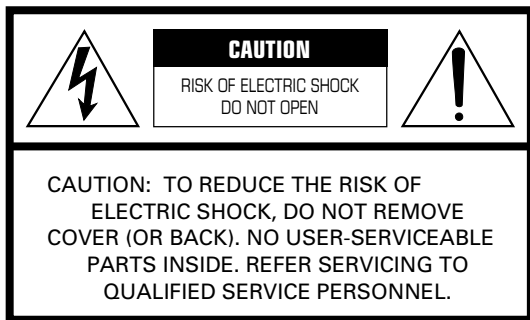

• Explanation of Graphical Symbols

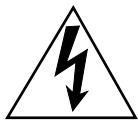

The lightning flash with arrowhead symbol, within an equilateral triangle, is intended to alert you to the presence of uninsulated “dangerous voltage” within the product’s enclosure that may be of sufficient magnitude to constitute a risk of electric shock to persons.



The exclamation point within an equilateral triangle is intended to alert you to the presence of important operating and maintenance (servicing) instructions in the literature accompanying the appliance.

**WARNING**  
TO REDUCE THE RISK OF FIRE OR ELECTRIC SHOCK, DO NOT EXPOSE THIS UNIT TO RAIN OR MOISTURE.

**IMPORTANT!**  
Please record the serial number of this unit in the space below.

Model:  
Serial No.:

The serial number is located on the rear of the unit. Retain this Owner’s Manual in a safe place for future reference.



- 6A A unit and cart combination should be moved with care. Quick stops, excessive force, and uneven surfaces may cause the unit and cart combination to overturn.
  - 7 Wall or Ceiling Mounting – The unit should be mounted to a wall or ceiling only as recommended by the manufacturer.
  - 8 Ventilation – The unit should be situated so that its location or position does not interfere with its proper ventilation. For example, the unit should not be situated on a bed, sofa, rug, or similar surface, that may block the ventilation openings; or placed in a built-in installation, such as a bookcase or cabinet that may impede the flow of air through the ventilation openings.
  - 9 Heat – The unit should be situated away from heat sources such as radiators, stoves, or other appliances that produce heat.
  - 10 Power Sources – The unit should be connected to a power supply only of the type described in the operating instructions or as marked on the unit.
  - 11 Power-Cord Protection – Power-supply cords should be routed so that they are not likely to be walked on or pinched by items placed upon or against them, paying particular attention to cords at plugs, convenience receptacles, and the point where they exit from the unit.
  - 12 Cleaning – The unit should be cleaned only as recommended by the manufacturer.
  - 13 Nonuse Periods – The power cord of the unit should be unplugged from the outlet when left unused for a long period of time.
  - 14 Object and Liquid Entry – Care should be taken so that objects do not fall into and liquids are not spilled into the inside of the unit.
  - 15 Damage Requiring Service – The unit should be serviced by qualified service personnel when:
    - A. The power-supply cord or the plug has been damaged; or
    - B. Objects have fallen, or liquid has been spilled into the unit; or
    - C. The unit has been exposed to rain; or
    - D. The unit does not appear to operate normally or exhibits a marked change in performance; or
    - E. The unit has been dropped, or the cabinet damaged.
  - 16 Servicing – The user should not attempt to service the unit beyond those means described in the operating instructions. All other servicing should be referred to qualified service personnel.
  - 17 Power Lines – An outdoor antenna should be located away from power lines.
  - 18 Grounding or Polarization – Precautions should be taken so that the grounding or polarization is not defeated.
- 1 Read Instructions – All the safety and operating instructions should be read before the unit is operated.
  - 2 Retain Instructions – The safety and operating instructions should be retained for future reference.
  - 3 Heed Warnings – All warnings on the unit and in the operating instructions should be adhered to.
  - 4 Follow Instructions – All operating and other instructions should be followed.
  - 5 Water and Moisture – The unit should not be used near water – for example, near a bathtub, washbowl, kitchen sink, laundry tub, in a wet basement, or near a swimming pool, etc.
  - 6 Carts and Stands – The unit should be used only with a cart or stand that is recommended by the manufacturer.

## FCC INFORMATION (for US customers only)

### 1. IMPORTANT NOTICE: DO NOT MODIFY THIS UNIT!

This product, when installed as indicated in the instructions contained in this manual, meets FCC requirements. Modifications not expressly approved by Yamaha may void your authority, granted by the FCC, to use the product.

### 2. IMPORTANT:

When connecting this product to accessories and/or another product use only high quality shielded cables. Cable/s supplied with this product MUST be used. Follow all installation instructions. Failure to follow instructions could void your FCC authorization to use this product in the USA.

### 3. NOTE:

This product has been tested and found to comply with the requirements listed in FCC Regulations, Part 15 for Class "B" digital devices. Compliance with these requirements provides a reasonable level of assurance that your use of this product in a residential environment will not result in harmful interference with other electronic devices.

This equipment generates/uses radio frequencies and, if not installed and used according to the instructions found in the users manual, may cause interference harmful to the operation of other electronic devices.

Compliance with FCC regulations does not guarantee that interference will not occur in all installations. If this product is found to be the source of interference, which can be determined by turning the unit "OFF" and "ON", please try to eliminate the problem by using one of the following measures:

Relocate either this product or the device that is being affected by the interference.

Utilize power outlets that are on different branch (circuit breaker or fuse) circuits or install AC line filter/s.

In the case of radio or TV interference, relocate/reorient the antenna. If the antenna lead-in is 300 ohm ribbon lead, change the lead-in to coaxial type cable.

If these corrective measures do not produce satisfactory results, please contact the local retailer authorized to distribute this type of product. If you can not locate the appropriate retailer, please contact Yamaha Electronics Corp., U.S.A. 6660 Orangethorpe Ave, Buena Park, CA 90620.

The above statements apply ONLY to those products distributed by Yamaha Corporation of America or its subsidiaries.

## We Want You Listening For A Lifetime

YAMAHA and the Electronic Industries Association's Consumer Electronics Group want you to get the most out of your equipment by playing it at a safe level. One that lets the sound come through loud and clear without annoying blaring or distortion – and, most importantly, without affecting your sensitive hearing. Since hearing damage from loud sounds is often undetectable until it is too late, YAMAHA and the Electronic Industries Association's Consumer Electronics Group recommend you to avoid prolonged exposure from excessive volume levels.



# ENGLISH

## INTRODUCTION

Thank you for purchasing this YAMAHA product. We hope it will give you many years of trouble-free enjoyment. For the best performance, read this manual carefully. It will guide you in operating your YAMAHA product.

## FEATURES

- Playback of CD-R, CD-RW, and Prerecorded CD Disc Formats
- Recording to CD-R and CD-RW Disc Formats
- Remote Control Capability
- Car Sound Processing (Dynamic Range Compression Recording)
- Sampling Rate Converter
- Synchronized Recording
- Digital Recording Level Adjustment
- 4 Times Speed Finalization
- 4 Times Speed Erase
- CD Direct Digital Input Recording
- Automatic and Manual Track Marking
- Optical and Coaxial Digital Input and Output
- Random Access Programmable Play
- Single Track/Entire Disc Repeat Play
- Random-Sequence Play
- PHONES jack
- Adjustable Display Brightness

## CONTENTS

<b>PRECAUTIONS</b> .....	2
<b>DISCS COMPATIBLE WITH THIS UNIT</b> .....	3
<b>GETTING STARTED</b> .....	4
Supplied accessories .....	4
Notes on the transportation pad .....	4
The remote control .....	5
Connections .....	6
<b>NAMES OF BUTTONS AND CONTROLS</b> .....	8
Front panel .....	8
Display .....	8
Remote control .....	9
<b>BASIC OPERATION</b> .....	10
Turning on the power and loading a disc .....	10
Removing the disc and turning the power off .....	11
Selecting a time display .....	11
<b>RECORDING FUNCTIONS</b> .....	12
Recording modes .....	12
Synchronized recording of a single track .....	13
Synchronized recording of ALL tracks .....	14
Synchronized recording with finalization .....	15
Manual recording .....	16
Setting the recording levels .....	17
Manual track marking .....	18
Recording directly from a source CD .....	18
Applying dynamic range compression to a recording .....	19
Finalization .....	20
Track and Disc Erase (CD-RW discs only) .....	21
<b>PLAYBACK FUNCTIONS</b> .....	23
Playing a CD disc .....	23
Searching for a track .....	24
Scanning forward or backward rapidly .....	24
Program play .....	25
Random sequence play .....	26
Repeat play .....	27
Index search .....	27
<b>OTHER FUNCTIONS</b> .....	28
Changing the brightness of the display .....	28
Listening with headphones .....	28
<b>ADDITIONAL INFORMATION</b> .....	29
CD preventive care .....	29
Display messages .....	30
Troubleshooting .....	31
SCMS copy protection .....	32
CD-Recorder system notes and limitations .....	33
Specifications .....	34

## CAUTIONS

- To assure the finest performance, please read this manual carefully. Keep it in a safe place for future reference.
- Install your unit in a well ventilated, cool, dry, clean place – away from windows, heat sources, vibration, dust, moisture, or cold. To avoid humming sounds, locate the unit away from other electrical appliances, motors, and transformers. To prevent fire or electrical shock, do not expose to rain and water.
- Do not operate the unit upside-down. It may overheat, possibly causing damage.
- Never open the cabinet. If something drops into the set, contact your dealer.
- Do not use force on switches, knobs or cords.
- When not planning to use this unit for long periods of time (i.e., vacation, etc.), disconnect the AC power plug from the wall outlet.
- Grounding or polarization – Precautions should be taken so that the grounding or polarization of the unit is not defeated.
- Do not clean the unit with chemical solvents; this might damage the finish. Use a clean, dry cloth.
- Be sure to read the “Troubleshooting” section on common operating errors before concluding that your unit is faulty.
- Do not place another component on top of this unit, as damage or discoloration on the surface of the unit may result.
- To prevent damage by lightning, disconnect the power cord from the wall outlet during an electrical storm.
- When disconnecting the power cord from the wall outlet, grasp the plug; do not pull the cord.
- Do not plug the AC power plug to the wall outlet before you finish all connections.
- The voltage to be used must be the same as that specified on this unit. Using this unit with a higher voltage than that which is specified is dangerous and may result in a fire or other type of accident causing damage. YAMAHA will not be held responsible for any damage resulting from use of this unit with a voltage other than that which is specified.
- Sudden temperature changes and storage or operation in an extremely humid environment may cause condensation inside the cabinet.
- When this unit is shipped, there is a protective pad in the disc tray. For correct operation of this unit, remove before use.

### CAUTION FOR MOVING THE UNIT

Before moving the unit, first check that there is no disc in the disc tray. To prevent malfunction of this unit, be sure to insert the transportation pad in the disc tray as described on page 4. Finally, press **POWER** to turn the unit off, and disconnect the AC power plug from the wall outlet.

### CAUTION

Use of controls or adjustments or performance of procedures other than those specified herein may result in hazardous radiation exposure.

As the laser beam used in this compact disc player is harmful to the eyes, do not attempt to disassemble the cabinet. Refer servicing to qualified personnel only.

### For Canadian Customers

To prevent electric shock, match wide blade of plug to wide slot and fully insert.

This Class B digital apparatus complies with Canadian ICES-003.

## Discs that can be used for recording

Be sure to use only CD-R and CD-RW discs made by reliable manufacturers.

CD-R and CD-RW digital audio discs that display either of the following marks can be used with this unit.



In addition to these marks being present on the disc, check that at least one of the following phrases can also be found on the disc or disc case.

- FOR CONSUMER
- FOR CONSUMER USE
- FOR MUSIC USE ONLY

### **Regarding discs that can be used for recording**

- CD-R discs can only be recorded on once, and the recorded material cannot be erased.
- CD-RW discs can be recorded on, have the recorded material erased, and then recorded on again any number of times.

### **The following discs cannot be used for recording on this unit.**

- Discs bearing marks other than those shown above.
- Discs intended for recording computer data.
- Discs intended for professional use or labeled "FOR PROFESSIONAL USE ONLY".

## Discs that can be played back

In addition to CD-R and CD-RW digital audio discs described above, commercially available pre-recorded CD discs bearing the mark shown below can also be played on this unit.



### **IMPORTANT**

- Small scratches, fingerprints, dust, foreign substances, or direct sunlight on the recorded surface of the disc may adversely affect the disc's ability to record and play back properly.
- Be sure to use a felt-tip pen or similar writing tool when writing on the label side of the disc. Do not use a ball-point pen, pencil, or other hard-tipped writing tool, as these may damage the disc and may adversely affect further recording on the disc.
- Be sure to read "CD preventive care" on page 29 for information on the proper care and handling of CD discs.

## Finalization of CD-R discs for playback on standard CD players

Although a partially recorded CD-R disc can be played on this unit, it cannot be played on a standard CD player until it has undergone a process known as "finalization". In the finalization process, the Table of Contents (TOC) is written onto the disc and further recording is not possible. However, this process makes it possible to play a CD-R disc on a standard CD player.

Some CD players may not play back the finalized CD-R discs properly due to differences in the playback system of different manufacturers.

See page 20 for more information on finalization.

## Playback of CD-RW discs

Please note that even after a CD-RW disc has been finalized, it still cannot be played on a standard CD player. CD-RW discs can only be played back on CD-RW compatible players such as this unit.

Additionally, CD-RW discs can be erased even after finalization has been performed, and recorded onto again. See pages 21 and 22 for more information on erasing recordings.

## Playback on DVD players

Before playing back a finalized CD-R or CD-RW discs on a DVD player, please check whether the DVD player is compatible with CD-R or CD-RW discs or not. Refer to the owner's manual of the DVD player for more information. If the DVD player is not compatible with CD-R or CD-RW discs, do not attempt to play them on the DVD player.

## Regarding erasure or loss of data

Yamaha and suppliers accept no liability for the loss of data or any problems caused as a result. As a precaution, it is recommended that the discs are tested after they have been written to. Furthermore, under no circumstances does Yamaha and suppliers guarantee the reliability of the discs.

### **Note**

Please check the copyright laws in your country to record from records, compact discs, radio, etc. Recording of copyright material may infringe copyright laws.

## Supplied accessories

After unpacking, check that the following parts are contained.

- Remote Control

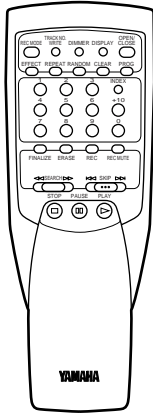

- Batteries (size AA, UM-3, R6) (2)

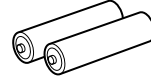

- RCA Pin Cables (2)

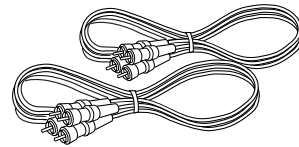

- Optical Fiber Cable

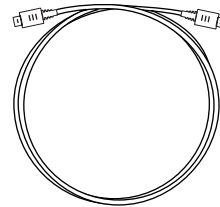

## Notes on the transportation pad

### Before using the unit

This unit is shipped with a transportation pad inserted in the disc tray to prevent impact to the internal mechanism that could occur during transportation. Before using this unit, press **POWER** on the front panel to turn the power on, press  $\triangle$  **OPEN/CLOSE** (**OPEN/CLOSE** on the remote) to open the disc tray, and remove the pad.

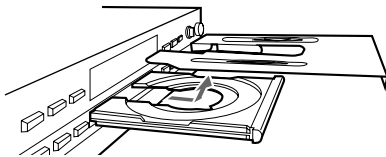

### Storing the transportation pad

It is recommended to use the transportation pad whenever the unit is moved. Therefore, store the transportation pad for future transportation of the unit.

### Installing the transportation pad

- 1 Press **POWER** on the front panel to turn the power on.
- 2 Press  $\triangle$  **OPEN/CLOSE** (**OPEN/CLOSE** on the remote) to open the disc tray.
- 3 Place the transportation pad in the disc tray.

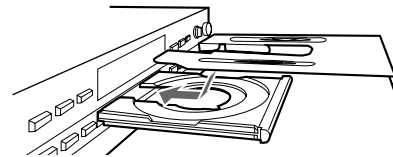

- 4 Press  $\triangle$  **OPEN/CLOSE** (**OPEN/CLOSE** on the remote) to close the disc tray.

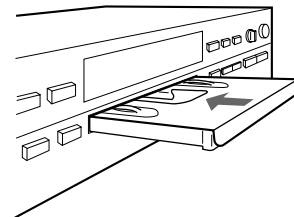

- If a portion of the transportation pad remains out of the unit, push gently to slide it into the unit.
- 5 Press **POWER** on the front panel to turn the power off.

## The remote control

### Loading the batteries for the remote control

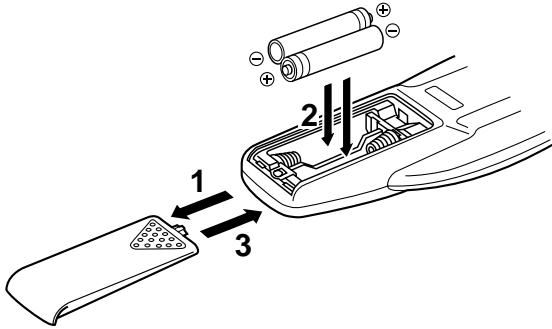

### Battery replacement

If you find that the remote control must be used closer to the main unit than usual, the batteries are weak. Replace batteries with new ones.

### Notes

- Use only AA, UM-3, R6 batteries for replacement.
- Be sure the polarities are correct. (See the illustration inside the battery compartment.)
- Remove the batteries if the remote control will not be used for an extended period of time.
- If batteries leak, dispose of them immediately. Avoid touching the leaked material or letting it come in contact with clothing, etc. Clean the battery compartment thoroughly before installing new batteries.

### Remote control operation range

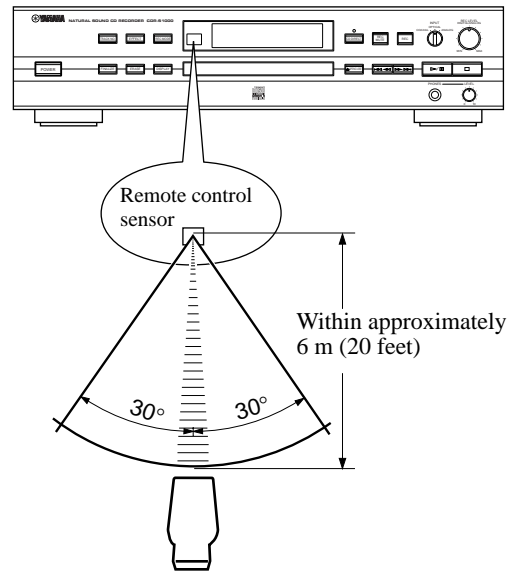

### Notes

- There should be no large obstacles between the remote control and the main unit.
- If the remote control sensor is directly illuminated by strong lighting (especially an inverter type of fluorescent lamp, etc.), it might cause the remote control not to work correctly. In this case, reposition the main unit to avoid direct lighting.



## Connections

**Do not plug in this unit or other components until all connections are completed.**

- Connections should be made to the correct input and output jacks of the amplifier or other components.
- To record a wider variety of sources, it is recommended to make both analog and digital connections to this unit.
- Arrow marks (→) in the illustration below indicate the direction of the audio signal.
- Guidelines for making both analog and digital connections to this unit are outlined on this and the following page.
- **When all connections are complete, plug in this unit to a wall outlet.**

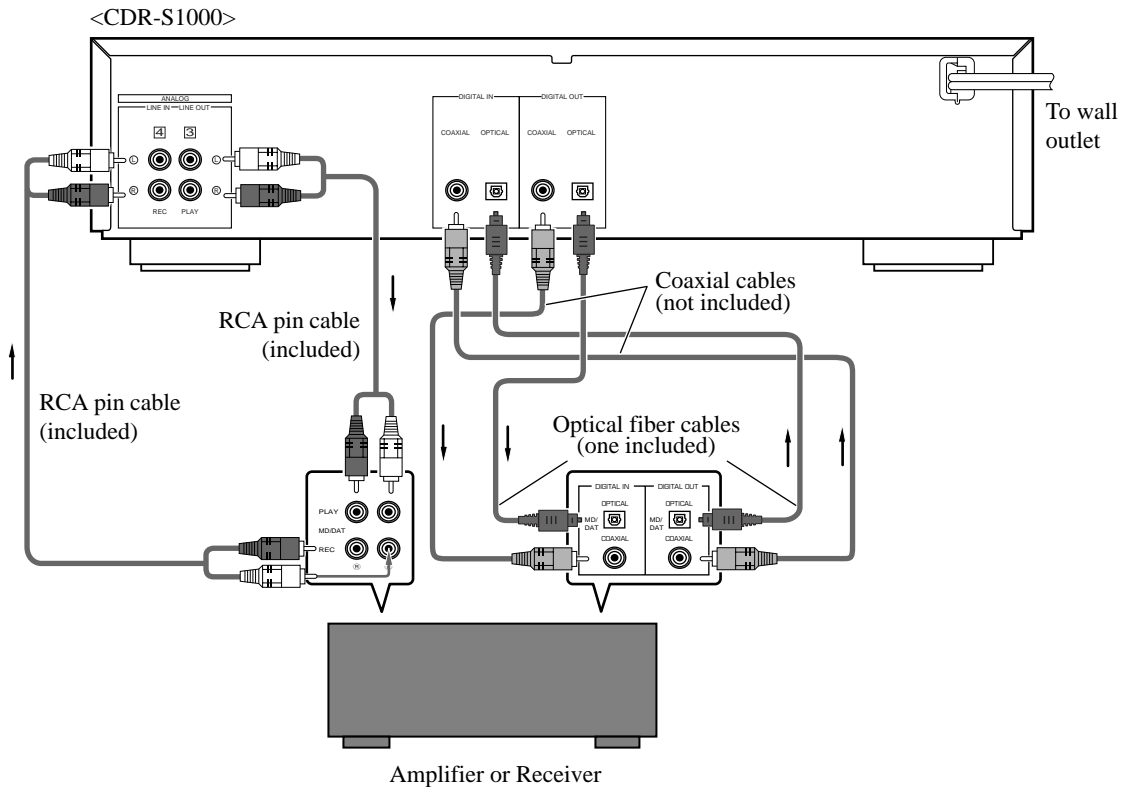

### Digital connections using the DIGITAL OPTICAL and COAXIAL jacks

- Before using the **DIGITAL OPTICAL** jacks, be sure to remove the jack covers. Replace the jack covers in order to protect the jacks from dust when they are not being used.
  - Make connections from the **DIGITAL OPTICAL** jacks on this unit to the “MD/DAT” (or equivalent) digital optical jacks on an amplifier or receiver by using optical fiber cables.
  - Make connections from the **DIGITAL COAXIAL** jacks on this unit to the “MD/DAT” (or equivalent) digital coaxial jacks on an amplifier or receiver by using commercially available coaxial cables.
- \* Do not connect the digital audio coaxial cable to analog line jacks. If connection is made, noise will be produced.

Continued on next page

## Analog connections using the LINE IN and OUT jacks

- Be sure that the left (“L”) and right (“R”) **LINE IN (REC)** and **LINE OUT (PLAY)** jacks are connected correctly.
- Connect the **LINE IN (REC)** and **LINE OUT (PLAY)** jacks to the “MD/DAT” (or equivalent) jacks of the amplifier or receiver. For additional details concerning these connections, refer to the operating instructions for the amplifier being used.
- Be sure to connect the **LINE OUT (PLAY)** jacks on this unit to the **LINE IN (PLAY)** jacks on the amplifier, and similarly the **LINE IN (REC)** jacks on this unit to the **LINE OUT (REC)** jacks on the amplifier.
- The **LINE IN (REC)** and **LINE OUT (PLAY)** jacks of this unit are numbered **4** and **3** respectively. When connecting this unit with a YAMAHA amplifier or receiver whose jacks on the rear panel are numbered as **1**, **2**, **3**, etc., connect the **LINE IN (REC)** and **LINE OUT (PLAY)** jacks of this unit to the input jacks numbered **4** and **3** on the rear of the amplifier or receiver.

## To select an input source using INPUT on the front panel

With this recorder, it is possible to make analog, digital optical, and digital coaxial connections. When recording, use **INPUT** on the front panel to select which of the three types of signal to input.

- When recording a digital source, set **INPUT** to **OPTICAL** to record the digital signal input from the **DIGITAL IN OPTICAL** jack.
- When recording a digital source, set **INPUT** to **COAXIAL** to record the digital signal input from the **DIGITAL IN COAXIAL** jack.
- When recording an analog source, set **INPUT** to **ANALOG** to record the signal input from the **LINE IN** jacks.

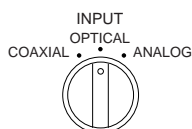

- This recorder outputs both analog and digital signals simultaneously regardless of the **INPUT** setting. Please refer to the instructions supplied with the amplifier, etc. for details on how to select the preferred signal type.
- When **INPUT** is set to either **OPTICAL** or **COAXIAL**, the sampling rate indicator corresponding to the digital sampling rate of the input source signal lights in the display.

## Front panel

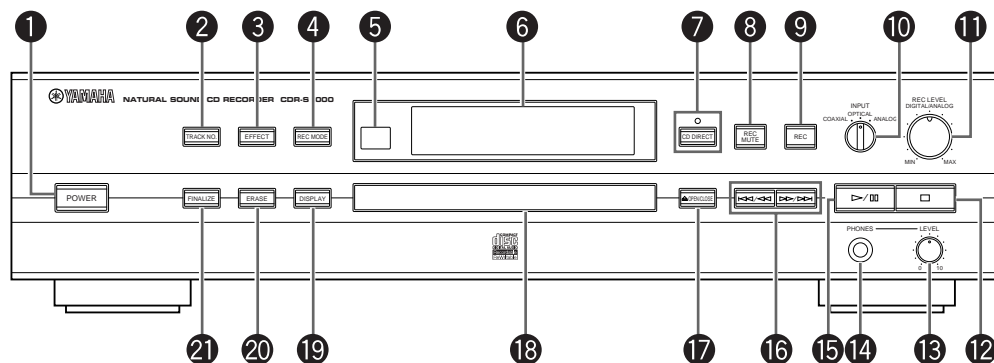

- ① **POWER** (P.10/P.11)
- ② **TRACK NO.** (P.18)
- ③ **EFFECT** (P.19)
- ④ **REC MODE** (P.13 to P.15)
- ⑤ Remote control sensor (P.5)
- ⑥ Display (P.11)
- ⑦ **CD DIRECT** (P.18)
- ⑧ **REC MUTE** (P.16)
- ⑨ **REC** (P.13 to P.16)
- ⑩ **INPUT** (P.7)
- ⑪ **REC LEVEL DIGITAL/ANALOG** (P.17)
- ⑫ □ (Stop) (P.23)
- ⑬ **LEVEL** (P.28)
- ⑭ **PHONES** (P.28)
- ⑮ ▷/⏸ (Play/Pause) (P.23)
- ⑯ ⏮/⏪ ⏩/⏭ (Skip/Search) (P.24)
- ⑰ ≡ **OPEN/CLOSE** (P.4/P.10/P.11)
- ⑱ Disc tray (P.4/P.10/P.11)
- ⑲ **DISPLAY** (P.11)
- ⑳ **ERASE** (P.21/P.22)
- ㉑ **FINALIZE** (P.20)

## Display

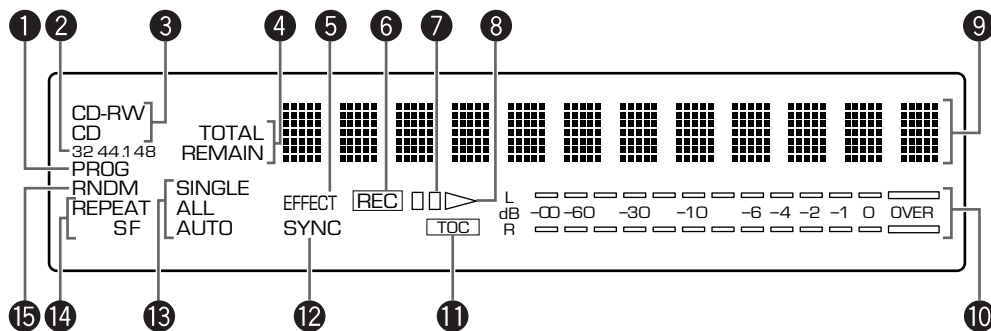

- ① **PROG** indicator (P.25)
- ② Sampling rate indicators (P.7)
- ③ Disc format indicator (P.13 to P.16)
- ④ **TOTAL/REMAIN** indicators (P.11)
- ⑤ **EFFECT** indicator (P.19)
- ⑥ **REC** indicator (P.13 to P.16)
- ⑦ □□ indicator (P.13 to P.16/P.23)
- ⑧ ▷ indicator (P.11/P.23)
- ⑨ Multi-information display (P.11)
- ⑩ Level indicator (P.17)
- ⑪ **TOC** indicator (P.20/P.22)
- ⑫ **SYNC** indicator (P.13 to P.15)
- ⑬ **SINGLE/ALL/AUTO** indicators (P.13 to P.15)
- ⑭ **REPEAT S/F** indicators (P.27)
- ⑮ **RNDM** indicator (P.26)

## Remote control

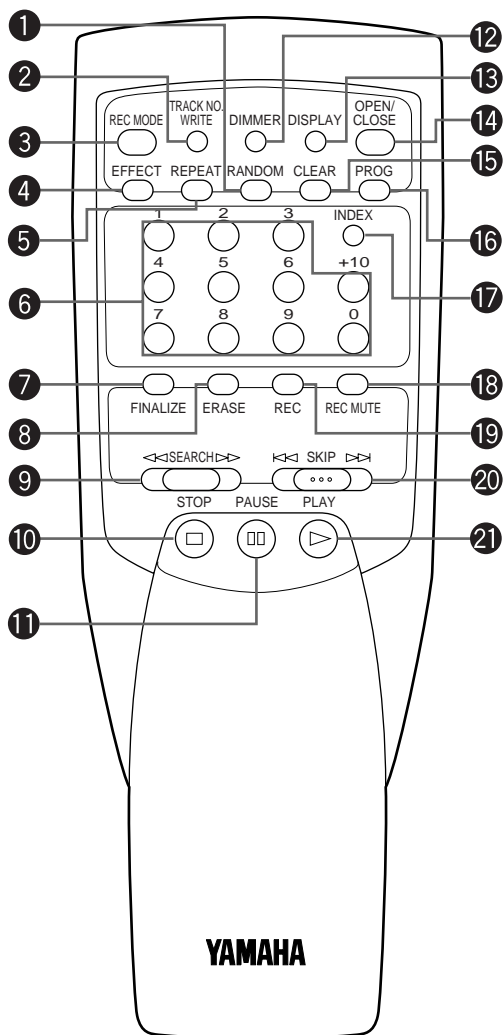

- ① **RANDOM** (P.26)
- ② **TRACK NO. WRITE** (P.18)
- ③ **REC MODE** (P.13 to P.15)
- ④ **EFFECT** (P.19)
- ⑤ **REPEAT** (P.27)
- ⑥ **Numeric buttons** (P.23/P.25/P.27)
- ⑦ **FINALIZE** (P.20)
- ⑧ **ERASE** (P.21/P.22)
- ⑨ **<< SEARCH >>** (P.24)
- ⑩ **STOP** □ (P.23)
- ⑪ **PAUSE** □□ (P.23)
- ⑫ **DIMMER** (P.28)
- ⑬ **DISPLAY** (P.11)
- ⑭ **OPEN/CLOSE** (P.4/P.10/P.11)
- ⑮ **CLEAR** (P.25/P.26)
- ⑯ **PROG** (P.25/P.26)
- ⑰ **INDEX** (P.27)
- ⑱ **REC MUTE** (P.16)
- ⑲ **REC** (P.13 to P.16)
- ⑳ **<< SKIP >>** (P.24)
- ㉑ **PLAY** ▷ (P.23)

## Turning on the power and loading a disc

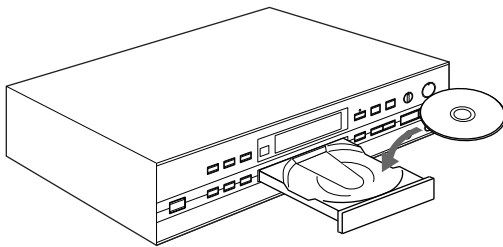
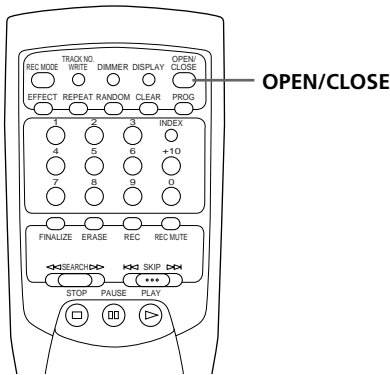
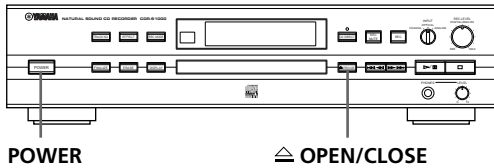

### To load a disc

- 1 Press **POWER** on the front panel to turn the power on.
- 2 Press  $\triangle$  **OPEN/CLOSE** (**OPEN/CLOSE** on the remote) to open the disc tray.
- 3 Load a disc using the disc guide to align the disc correctly in the disc tray.
  - When loading a prerecorded CD disc, load the disc with the label side up.
  - When loading a CD-R or CD-RW disc for recording, load with the recordable side down.
- 4 Press  $\triangle$  **OPEN/CLOSE** (**OPEN/CLOSE** on the remote) to close the disc tray.
- 5 Select the function you want.
  - For disc recording functions, see pages 12 to 20.
  - For disc playback functions, see pages 23 to 27.

### To load an 8 cm (3 in.) CD disc

Place it in the inner recessed area of the disc tray. Do not put a normal 12 cm (5 in.) CD disc on top of an 8 cm (3 in.) CD disc.

### Note

- You can also close the disc tray by pressing the front edge of the disc tray gently. Play begins automatically if the tray is closed by pressing  $\triangleright$ /00 on the front panel or **PLAY**  $\triangleright$ , a numeric button, or **RANDOM** on the remote. However, the display will not show the total number of tracks or the total recorded time of the disc.

### When a disc is loaded

When a disc is loaded in the recorder, the recorder performs a number of internal operations to determine the format and content of the disc. During this time, “Reading” appears in the display. This process requires approximately 10 seconds to complete for any type of disc.

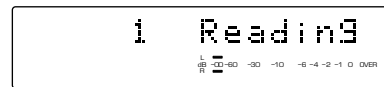

When a new CD-R or CD-RW disc is loaded in the recorder, OPC (Optimum Power Calibration) is usually performed as well. OPC optimizes the laser power to the reflectivity of the disc. During this time, “OPC Adjust” appears in the display. This process requires an additional 15 seconds to complete. Recording is not possible until these operations are complete.

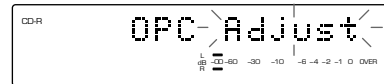

After the disc has been read and any necessary internal adjustments have been performed, one of the following displays appear, and normal operation of the recorder is possible.

A prerecorded audio CD disc is loaded in the recorder.

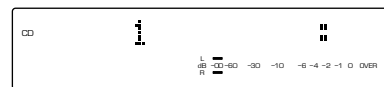

A CD-R or CD-RW disc that has not yet been recorded on is loaded in the recorder.



## Removing the disc and turning the power off

### Important

Do not turn off the power during finalization of a CD-R or CD-RW disc (after recording). Doing so may result in a misoperation in which recorded material may be lost and further recording on the disc made impossible. For more information on finalization of CD-R and CD-RW discs, please see page 20.

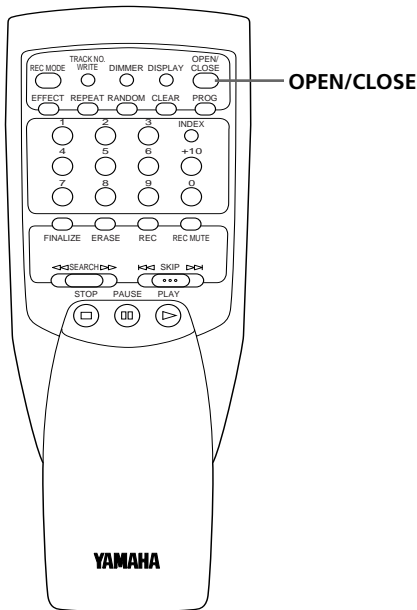
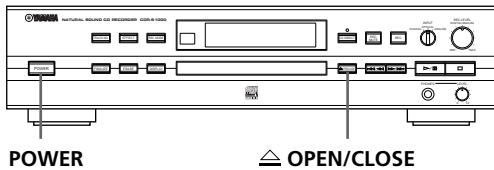

- 1 Press **△ OPEN/CLOSE** (**OPEN/CLOSE** on the remote) to open the disc tray and remove the disc.
  - If a disc is playing, playback is stopped automatically, and then the disc tray opens.
- 2 Press **△ OPEN/CLOSE** (**OPEN/CLOSE** on the remote) again to close the disc tray.
- 3 Press **POWER** on the front panel to turn the power off.

## Selecting a time display

You can change the disc information that is shown in the display by pressing **DISPLAY**. Each time **DISPLAY** is pressed, the display changes as follows.

### When a disc is playing

Elapsed time of the track now playing

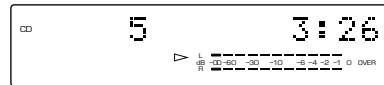

Remaining time of the track now playing

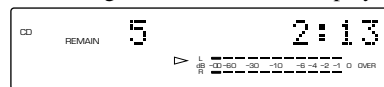

Total disc play time

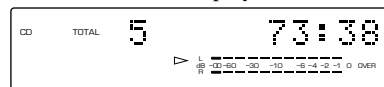

Total remaining time on the disc

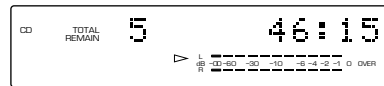

### When a disc is being recorded

Elapsed time of the track being recorded

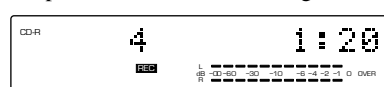

Total time recorded on the disc

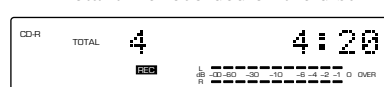

Total remaining recording time on the disc



## Recording modes

This recorder features a number of recording modes allowing you to make recordings from a wide variety of program sources (both analog and digital).

- When using this unit to make recordings, subcode information that may be present in the source audio signal such as CD TEXT, index data, etc., will not be recorded.

### Before recording

- Set your amplifier or receiver to the source to be recorded.
- Check that **INPUT** on the front panel is set appropriately for the source to be recorded as described on page 7.

## About the recording modes

Synchronized recording is recommended when making a digital recording from a CD or MD, etc.

Manual recording is recommended when making an analog recording.

### Single track synchronized recording

After recording a single track, the unit is put in the record pause mode. This mode is convenient for recording a mix of tracks from different sources. See page 13 for this procedure.

### ALL track synchronized recording

When the source component starts to play, all tracks are recorded and the recording automatically stops after the last track. This mode is convenient for recording an entire CD, DAT, MD or LP, etc. See page 14 for this procedure.

### Full AUTO synchronized recording

This mode automatically finalizes the disc after ALL track synchronized recording. See page 15 for this procedure.

### Manual recording

This recording mode is used mainly when manual control of the recording is required or preferred. Recording is started and stopped manually. See page 16 for this procedure.

#### IMPORTANT

- Do not turn off the power during recording. If the power is turned off, recorded material may be lost and the disc may not perform normally.
- If a power failure occurs or if the power cord is pulled out of the wall outlet while recording on a CD-RW disc, any material recorded before the information is written to the PMA (Program Memory Area) will be lost and left unrecorded. When using a CD-R disc, the disc will no longer be usable.
- During recording, make sure that the recorder is not subjected to shock or vibration as this may cause skips or jumps to be included in the recording.

### In the following cases recording is NOT possible

- When the CD indicator is lit indicating that a CD disc or finalized CD-R disc is loaded in the recorder.
- When the CD-RW and TOC indicators are lit indicating that a finalized CD-RW disc is loaded in the recorder.
- When there is no recording time remaining on the disc and “Disc Full” appears in the display.
- When 99 tracks have been recorded and “Track Full” appears in the display. Only 99 tracks may be recorded on a CD disc.
- When the CD-R or CD-RW disc loaded in the recorder is not intended for recording audio and “Not Audio” appears in the display.

### Notes

- If a source component connected to the DIGITAL IN jacks on this unit is recorded by another recording device connected to the DIGITAL OUT jacks on this unit, the recording function may not perform correctly.
- Depending on the source component, recording may not always be possible when using the digital input jacks on this unit.

### When recording onto a partially recorded disc

If a CD-R or CD-RW disc has some recording time remaining on it before finalization is performed, any of the recording modes can be performed as normal.

Recording is automatically started from the location immediately after the last recorded track on the disc.

### Before CD-R discs can be played on standard CD players – Finalization

When you have finished recording on a CD-R disc, it is necessary to finalize the disc to make it compatible with standard CD players. If this procedure is not performed, the CD-R disc will not be playable on a standard CD player.

- If Full AUTO synchronized recording is performed, finalization is automatically performed following the conclusion of recording.

#### Notes for synchronized recording

- When performing synchronized recording of a Video CD (audio portion only), the synchronized recording function may not work correctly depending on the source component being used to play the Video CD.
- Depending on the operation of the DVD player, this unit may not stop the synchronized recording although 20 seconds of silence is continued. In this case, press **STOP**  on the remote to stop this unit.
- Extremely low level signals will not be recognized during analog input signal recording and will be treated as silence. Be aware of low level signals during synchronized recording.
- Although it takes less than 100 msec to detect input signals in the synchronized recording mode, this unit may not record the first portion of input signals depending on discs. In this case, select the synchronized recording mode after the manual recording is started.

## Synchronized recording of a single track

This is a recording mode suitable for compiling single tracks from different audio sources. A new track marker is automatically placed at the start of the track.

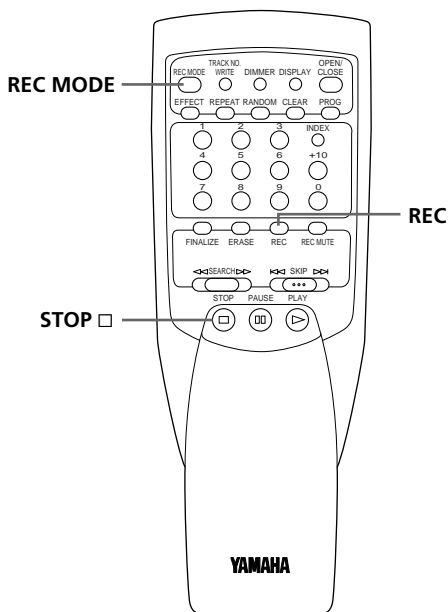
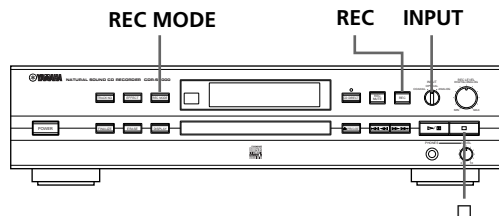

- 1 Load a CD-R or CD-RW disc containing space for recording.
  - To ensure proper recording, make sure that you have more than enough space on the disc.
- 2 Press **REC**.
  - This unit enters record pause mode.

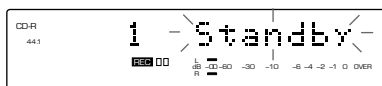

- 3 Set **INPUT** on the front panel to the appropriate input to be used for recording.

- 4 Adjust the recording level as described on page 17.
  - The recording level of digital and analog sources can be adjusted.
  - Start playing the source to set the recording level. When the recording level is set, stop playback of the source component.
  - The recording level cannot be changed when the CD DIRECT function is on.

- 5 Ensure that the source is in pause or stop mode, as synchronized recording cannot be started if the source is playing.
  - Confirm the correct track is selected before proceeding to the next step.

- 6 Press **REC MODE** once.
  - The SINGLE and SYNC indicators light in the display.

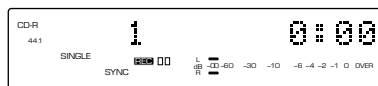

- 7 Start playing the source.
  - The unit starts recording automatically when it detects an audio signal.
  - When the track being recorded ends, "Standby" blinks in the display while information is being written to the PMA (Program Memory Area) and the unit is put in the record pause mode.
- 8 To record another track, repeat steps 5, 6, and 7.
- 9 After recording is complete, press **STOP** (on the remote) to cancel recording and put the unit in the stop mode.

**When you are finished recording, follow the finalization procedure described on page 20.**



# Synchronized recording of ALL tracks

This is a recording mode suitable for recording all of the material from a single audio source such as a CD, MD, cassette, or LP. Track markers are automatically placed between the tracks being recorded.

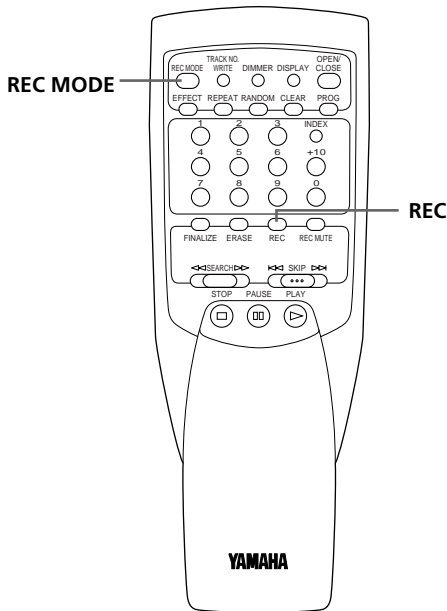
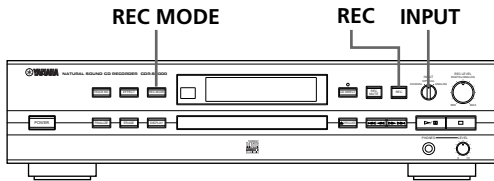

- 1 Load a CD-R or CD-RW disc containing space for recording.
  - To ensure proper recording, make sure that you have more than enough space on the disc.
- 2 Press **REC**.
  - This unit enters record pause mode.

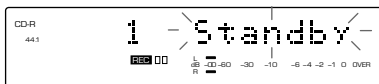

- 3 Set **INPUT** on the front panel to the appropriate input to be used for recording.

- 4 Adjust the recording level as described on page 17.
  - The recording level of digital and analog sources can be adjusted.
  - Start playing the source to set the recording level. When the recording level is set, stop playback of the source component.
  - The recording level cannot be changed when the CD DIRECT function is on.
- 5 Ensure that the source is in pause or stop mode, as synchronized recording cannot be started if the source is playing.
- 6 Press **REC MODE** twice.
  - The ALL and SYNC indicators light in the display.

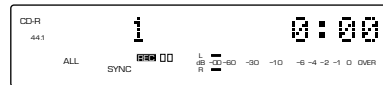

- 7 Start playing the source.
  - The unit starts recording automatically when it detects an audio signal.
  - When making a digital recording, a new track marker is placed each time a new track begins on the source component.
  - Depending on the source component, a new track marker may not always be placed correctly. When this occurs, use the manual track marking function.
  - When making an analog recording, spaces of silence are interpreted as track separations, and a new track marker is automatically placed when a new audio signal is detected. The silence should be about 4 seconds long. Automatic track marking may not be performed properly if the recording source has excessive noise or contains a lot of low level sounds. In this case, we recommend manual recording as described on page 16.
  - Once the unit has recorded 20 seconds of continuous silence, recording ends and "Wait" blinks in the display while information is being written to the PMA (Program Memory Area). After this is complete, the unit is put in the stop mode.
  - When making a recording using the program playback function of the source component, make sure that the space between each track is under 10 seconds.

When you are finished recording, follow the finalization procedure described on page 20.

## Synchronized recording with finalization

The Full AUTO synchronized recording mode automatically performs finalization after ALL track synchronized recording (described on the previous page). Finalization is the final process in recording a CD-R disc that makes it playable on standard CD players. (CD-RW discs can only be played back on a CD-RW compatible player, even if finalization is performed.) Refer to page 20 for more information on finalization.

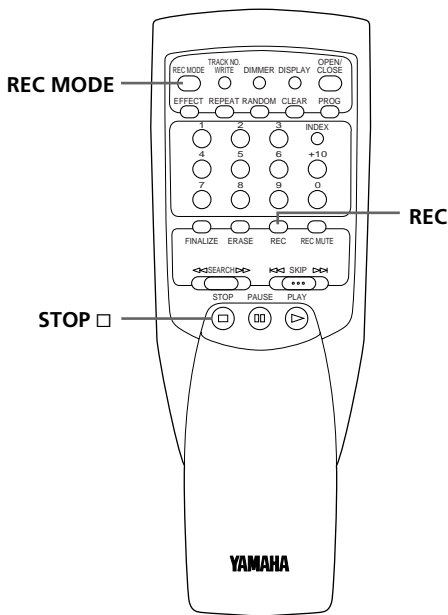
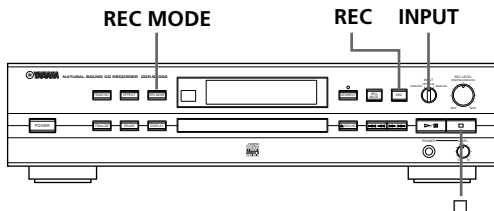

- 1 Load a CD-R or CD-RW disc containing space for recording.
  - To ensure proper recording, make sure that you have more than enough space on the disc.
- 2 Press **REC**.
  - This unit enters record pause mode.

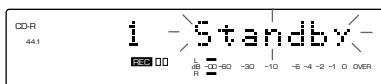

- 3 Set **INPUT** on the front panel to the appropriate input to be used for recording.

- 4 Adjust the recording level as described on page 17.
  - The recording level of digital and analog sources can be adjusted.
  - Start playing the source to set the recording level. When the recording level is set, stop playback of the source component.
  - The recording level cannot be changed when the CD DIRECT function is on.

- 5 Ensure that the source is in pause or stop mode, as synchronized recording cannot be started if the source is playing.

- 6 Press **REC MODE** three times.
  - The AUTO and SYNC indicators light in the display.

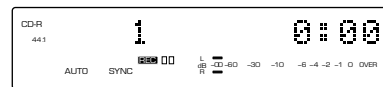

- 7 Start playing the source.

- The unit starts recording automatically when it detects an audio signal.

- 8 Once the unit has recorded 20 seconds of continuous silence, recording ends and "Wait" blinks in the display while information is being written to the PMA (Program Memory Area). After this is complete, finalization begins automatically.

- In the Full AUTO synchronized recording mode, the finalization process following the end of recording can be canceled by pressing **STOP** (on the remote) during the 20 seconds of silence at the end of the recording. If this is done, however, it will be necessary to perform finalization as described on page 20.
- When making a recording using the program playback function of the source component, make sure that the space between each track is under 10 seconds.
- Operation buttons do not respond once finalization has begun.
- Never turn the power off during finalization!
- System operation stops automatically without performing finalization when there is no more recording time or when 99 tracks have already been recorded.

# Manual recording

This is a recording mode used when manual control of the recording is required or preferred.

(Please note that synchronized recording (single or ALL) is recommended when making a digital recording from CD or MD, etc.)

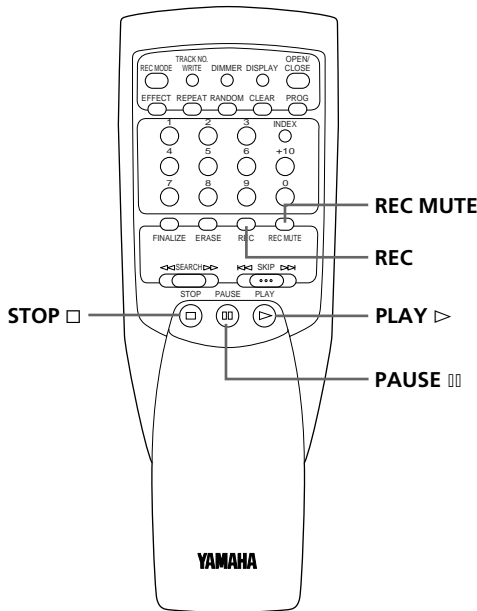
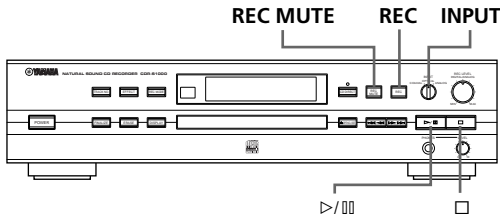

**1** Load a CD-R or CD-RW disc containing space for recording.

- To ensure proper recording, make sure that you have more than enough space on the disc.

**2** Press **REC**.

- This unit enters record pause mode.

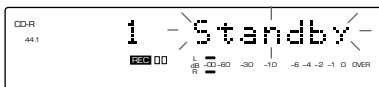

**3** Set **INPUT** on the front panel to the appropriate input to be used for recording.

**4** Adjust the recording level as described on the following page.

- The recording level of digital and analog sources can be adjusted.
- Start playing the source to set the recording level. When the recording level is set, stop playback of the source component.
- The recording level cannot be changed when the CD DIRECT function is on.

**5** Press **▷/||** (**PAUSE ||** or **PLAY ▷** on the remote) to start recording.

**6** Start playing the source.

**7** After recording is complete, press **□** (**STOP □** on the remote) to stop recording.

- “Wait” blinks in the display while information is being written to the PMA (Program Memory Area).

## To pause during recording

Press **▷/||** (**PAUSE ||** on the remote) to pause recording temporarily. “Standby” blinks in the display while information is being written to the PMA (Program Memory Area).

To resume recording, press **▷/||** (**PAUSE ||** or **PLAY ▷** on the remote).

## To record blank space at the end of a track

Press **REC MUTE**.

A 4-second blank space is recorded, and the unit automatically enters the record pause mode.

- The REC indicator blinks while blank space is being recorded.
- You can create blank spaces longer than 4 seconds by pressing and holding **REC MUTE**. The unit is put in the record pause mode when the button is released.
- **REC MUTE** cannot be used when the record pause mode is activated from the stop mode.

**When you are finished recording, follow the finalization procedure described on page 20.**

## Setting the recording levels

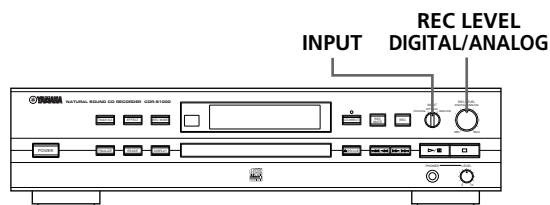

### Setting the digital recording level

The volume level of digital audio sources is often similar, however, level differences may be quite obvious between different digital audio sources and even between one recording and another. To maintain a consistent recording level in CD recordings, it is possible to change the volume of the input digital signal.

- Please note that the digital recording level cannot be adjusted when the CD DIRECT function is on (the CD DIRECT indicator is lit on the front panel).

To select the digital signal to be recorded, set **INPUT** to the appropriate digital input (**OPTICAL** or **COAXIAL**). To set the digital recording level, play the digital source to be recorded during record or record pause mode, and turn **REC LEVEL DIGITAL/ANALOG** to adjust the volume of the digital signal to a level that sounds appropriate. The digital volume can be adjusted up to a MAX of +12 dB and down to a MIN of -12 dB from the center position of 0 dB, the level of the input digital signal.

#### Notes

- Although some sources can be recorded with lower peak levels, setting the peak levels too low may degrade the quality of the recording.
- By pressing **CD DIRECT** (the CD DIRECT indicator lights on the front panel), the digital level is automatically set to that of the CD disc being recorded, and turning **REC LEVEL DIGITAL/ANALOG** has no effect.

### Setting the analog recording level

To select the analog signal, set **INPUT** to **ANALOG**. Turn **REC LEVEL DIGITAL/ANALOG** during record or record pause mode to adjust the analog recording level. For best results, play the loudest passage of the source to be recorded and watch the recording level meter in the display. Adjust **REC LEVEL DIGITAL/ANALOG** so that the highest peak causes the 0 dB level indicators to flicker. Do not set the recording level so that the OVER indicators light as it may produce distortion in the audio signal.

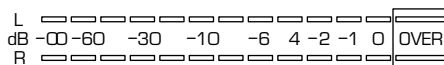

Should not light

## Manual track marking

You can manually mark tracks as you like anywhere in your recording.

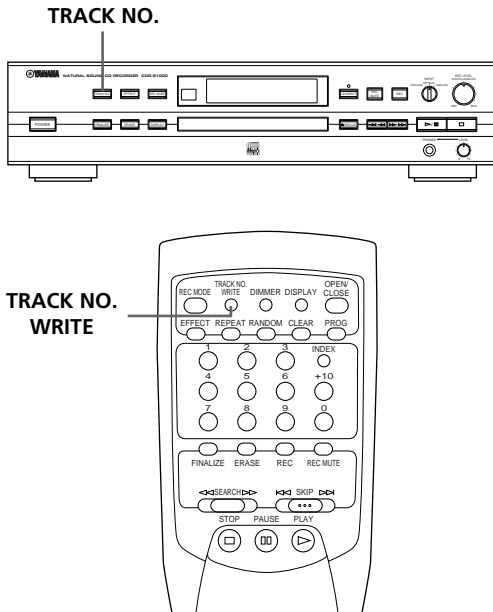

While recording, press **TRACK NO.** (**TRACK NO. WRITE** on the remote).

- A new track number is added at the location on the disc corresponding to the time **TRACK NO. WRITE** on the remote) is pressed.
- Please note that tracks cannot be shorter than 4 seconds, and that a disc cannot contain more than 99 tracks. Even if there is time remaining on the disc, further recording is impossible once 99 tracks have been recorded.

### Notes

- When digitally recording DAT sources, be sure to start recording on the CD-R disc after pausing the source at the beginning of a track (start ID, etc.).
- Manual track marking is recommended for the following:
  - \* When an analog source is being recorded that contains a section or numerous sections with levels too low to be detected on the level meter.
  - \* When recording digital satellite broadcasts
- Manual track marking is possible even during synchronized recording.

## Recording directly from a source CD

Because CD discs are recorded at a sampling rate of 44.1 kHz, this unit makes it possible to make a direct recording of another CD disc that bypasses unnecessary digital processing such as the sampling rate converter.

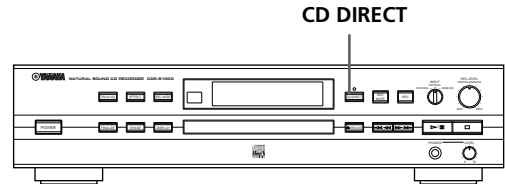

- 1 Press **CD DIRECT** while in record pause mode.
  - When the CD DIRECT function is on, the CD DIRECT indicator lights.



- 2 Perform one of the recording procedures as outlined on pages 13 to 16.
  - Any of the recording modes may be used.
  - When the CD DIRECT indicator is lit, recording level adjustment is not possible. Additionally, dynamic range compression cannot be applied to the recording.

### To turn off the CD DIRECT function

Press **CD DIRECT** again.

### Note

- Due to variances in recordings, the CD DIRECT function may not work with all CD discs. If the CD DIRECT function is not possible, pressing **CD DIRECT** causes the CD DIRECT indicator to blink for 3 seconds and then turn off.

## Applying dynamic range compression to a recording

CD discs can be enjoyed in car CD players, but often sounds can get lost when competing with engine noises and other factors. To remedy this problem, this recorder features an effect that essentially records a compressed sound range in which soft sounds are boosted and louder sounds are lowered and produces music that can be more fully enjoyed when listening to CDs in a car or similar environment.

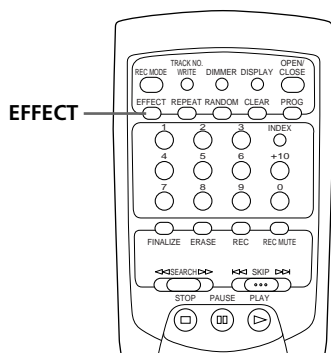
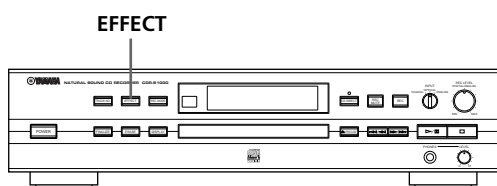

- 1 Press **EFFECT** in record or record pause mode.
  - The EFFECT indicator lights in the display.

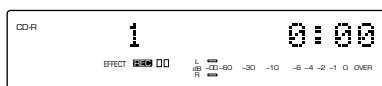

- 2 Perform one of the recording procedures as outlined on pages 13 to 16.
  - Any of the recording modes may be used.
  - The effects of the dynamic range compression can be heard during the recording process.
- 3 Press **EFFECT** again to cancel the effect.
  - The EFFECT indicator disappears from the display.
  - Dynamic range compression is automatically canceled if recording is stopped.

### Note

- Dynamic range compression cannot be applied to a recording when the CD DIRECT function is on.

# Finalization

Finalization is the process that concludes recording, and allows a CD-R disc to be played on a standard CD player. (Please note that CD-RW discs can only be played on a CD-RW compatible player even after finalization has been performed. CD-RW discs cannot be played on a standard CD player.)

- Please note that once a CD-R disc is finalized, recording is no longer possible. Please ensure the disc is in its final form before performing finalization.
- If the power is turned off or interrupted during finalization, the recorded material may be lost and the disc may not be usable.

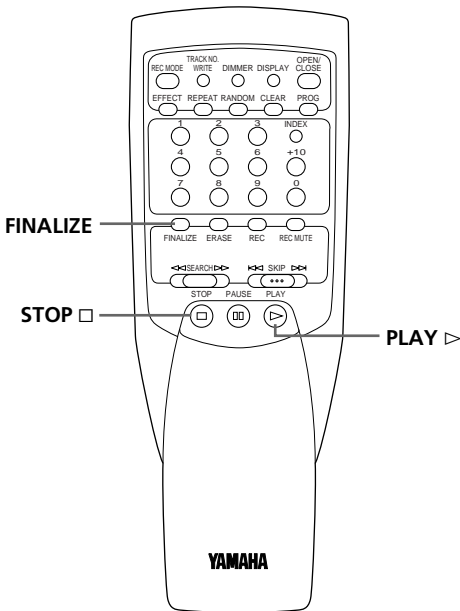
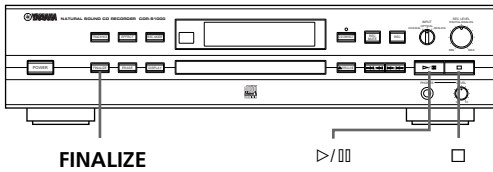

## To finalize a CD-R or CD-RW disc

- 1 Load a recorded (but not finalized) CD-R or CD-RW disc.
  - Before loading the disc, make sure there are no scratches, dust, fingerprints or similar marks on the disc. If necessary, clean the disc as described on page 29.
- 2 Press **FINALIZE**.



- If you want to cancel finalization, press  (**STOP**  on the remote).
- 3 Press **>/00 (PLAY ▷)** on the remote to start the finalization procedure.
    - The remaining time required for finalization to complete is displayed. Finalization can usually be completed within about 2 minutes.
    - When CD-R disc finalization is complete, the CD-R indicator changes to the CD indicator in the display, and the recorder is put in the stop mode.
    - When CD-RW disc finalization is complete, the TOC indicator lights in the display, and the recorder is put in the stop mode.

### Notes on finalization

- Once the finalization process has started, no other operation is possible until finalization has been completed.
- If the disc is marked or scratched, finalization may not be possible.
- Do not turn off the power or disconnect the power during finalization.

## Track and Disc Erase (CD-RW discs only)

CD-RW discs can be erased and new recordings can be made after material has been erased. The following types of erasing are possible with this unit.

### Last Track Erase

Erases the last track. This operation is not possible on a CD-RW disc that has been finalized or when only one track has been recorded on the disc.

### All Track Erase

Erases all of the tracks recorded on the disc. This operation is not possible on a CD-RW disc that has been finalized.

### TOC Erase

TOC Erase is only available on a CD-RW disc that has been finalized. After the TOC is erased, the effects of finalization are defeated, and further recording is possible.

### Disc Erase

This operation deletes all data on the disc. It is usually not necessary to perform this function, however, it may be used to recover a disc that was stopped during a finalization or erase operation, etc.

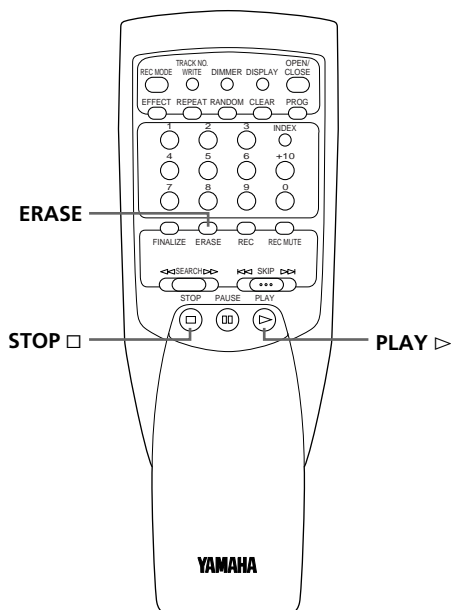
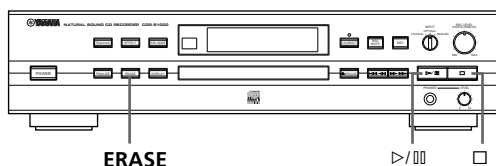

## To select an erase mode

Each time **ERASE** is pressed, the Erase mode changes as follows.

CD-RW discs that have not been finalized:

Erase off → Last Track Erase → All Track Erase

Finalized CD-RW discs:

Erase off → TOC erase

All CD-RW discs:

Holding down **ERASE** for at least 2 seconds initiates Disc Erase.

### Note

- When there is only one track recorded on a CD-RW that has not been finalized, only All Track Erase is possible.

### IMPORTANT

- Do not turn off the power during an erase procedure as this could cause the player to malfunction and make the disc unusable.
- If the message “Check Disc” appears during an erase operation and erasing stops, the disc may be damaged. Should this occur, inspect the disc and then try erasing it again.

## Last Track Erase

- 1 Load a CD-RW disc that has been recorded on.
  - This function is not possible on a finalized CD-RW disc.
- 2 Press **ERASE**.
  - “Erase LAST?”, appears in the display.
  - If you want to cancel the Erase mode, press **□** (**STOP** **□** on the remote).
- 3 Press **▷/00** (**PLAY** **▷** on the remote) to start the Last Track Erase process.
  - This operation requires several seconds to complete.
  - During Last Track Erase, “Erase” and the remaining time to completion appear in the display.
- 4 The recorder stops when Last Track Erase is complete.



## All Track Erase

- 1 Load a CD-RW disc that has been recorded on.
  - This function is not possible on a finalized CD-RW disc.
- 2 Press **ERASE** until “Erase ALL?” appears on the display.
  - If you want to cancel the Erase mode, press  (**STOP**  on the remote).
- 3 Press  $\triangleright/\square$  (**PLAY**  $\triangleright$  on the remote) to start the All Track Erase process.
  - This process requires from several seconds up to 3 minutes depending on the amount of recorded material.
  - During All Track Erase, “Erase” and the remaining time to completion appear in the display.
- 4 The recorder stops when All Track Erase is complete.

## TOC Erase

- 1 Load a CD-RW disc that has been finalized.
- 2 Press **ERASE**.
  - “Erase TOC?” appears in the display.
  - If you want to cancel the Erase mode, press  (**STOP**  on the remote).
- 3 Press  $\triangleright/\square$  (**PLAY**  $\triangleright$  on the remote) to start the TOC Erase process.
  - This process requires approximately 1 minute to complete.
  - During TOC Erase, “Erase” and the remaining time to completion appear in the display.
- 4 The recorder stops when TOC Erase is completed.

### Note

- When TOC Erase is complete, the TOC indicator goes out.

## Disc Erase

- 1 Load a CD-RW disc that has been recorded on.
  - The CD-RW disc may be finalized or not.
- 2 Press and hold **ERASE** for about 2 seconds.
  - “Erase DISC?” appears in the display.
  - If you want to cancel the Erase mode, press  (**STOP**  on the remote).
- 3 Press  $\triangleright/\square$  (**PLAY**  $\triangleright$  on the remote) to start the Disc Erase process.
  - This process requires approximately one-fourth the total time on the disc.
- 4 The recorder stops when Disc Erase is completed.

## Playing a CD disc

This unit is capable of playing CD, CD-R and CD-RW discs.

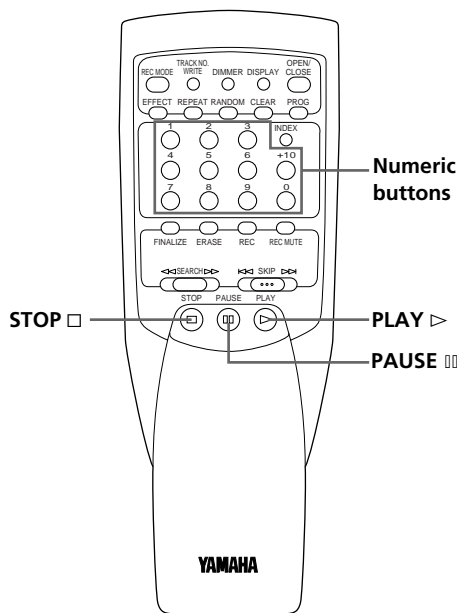
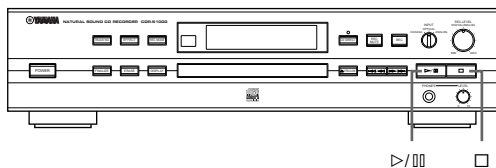

### To pause play temporarily

During playback, press ▷/|| (PAUSE || on the remote).  
To resume play, press ▷/|| (PAUSE || or PLAY ▷ on the remote).

### To stop play completely

During playback, press □ (STOP □ on the remote).

### To play a desired track number on the disc

Select a desired track by using the numeric buttons on the remote. The selected track number appears in the display.  
Example: To select track 25  
Press +10 twice, then immediately press 5 once.

#### Note

- If a track number higher than the highest track number on the disc is selected, the last track on the disc will be played.

### To play a CD disc

- 1 Turn the recorder's power on and load a disc as described on page 10.
- 2 Press ▷/|| (PLAY ▷ on the remote).
  - Playback starts from the beginning of track 1.

## Searching for a track

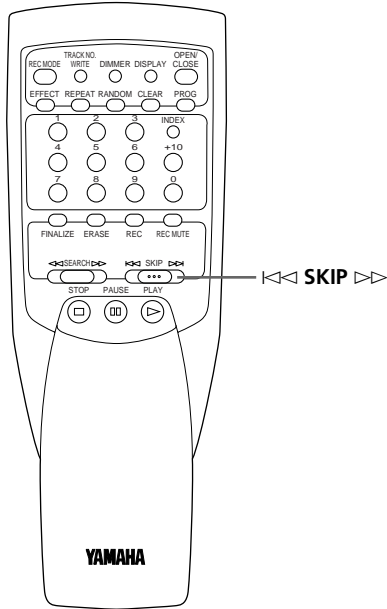
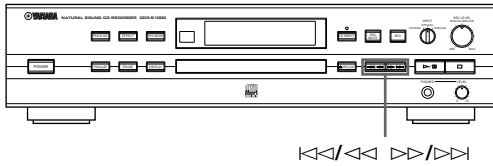

### To advance to the next track

During playback, press **SKIP** on the remote). Pressing **SKIP** repeatedly advances to other tracks.

### To return to the beginning of current track

During playback, press **SKIP** on the remote) once.

### To return to previous tracks

During playback, press **SKIP** on the remote) twice in succession to return to the previous track. Repeatedly press **SKIP** on the remote) to return to other previous tracks.

#### Note

- It is also possible to use **SKIP** or **SKIP** on the remote) to cue a track when the unit is paused or stopped. When a track is cued in this manner, playback does not begin until **PLAY** on the remote) is pressed.

## Scanning forward or backward rapidly

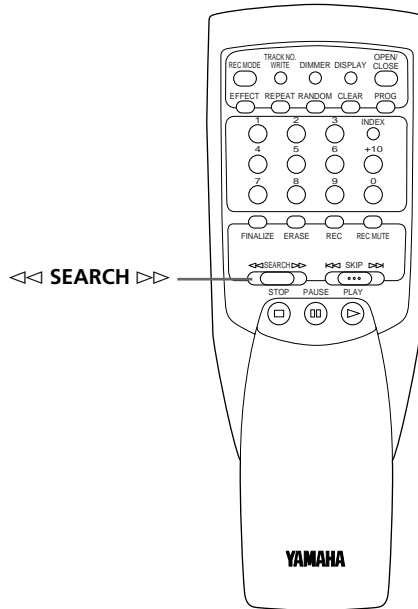
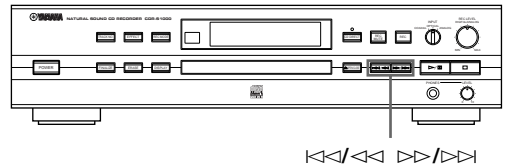

### To go forward rapidly

Press and hold **SEARCH** during play. When the button is released, normal playback is resumed.

### To go backward rapidly

Press and hold **SEARCH** during play. When the button is released, normal playback is resumed.

#### Notes

- The sound cannot be heard during scanning in either direction.
- Scanning can also be performed while disc play is paused.

## Program play

You can enjoy listening to your favorite tracks in any desired order by programming tracks.

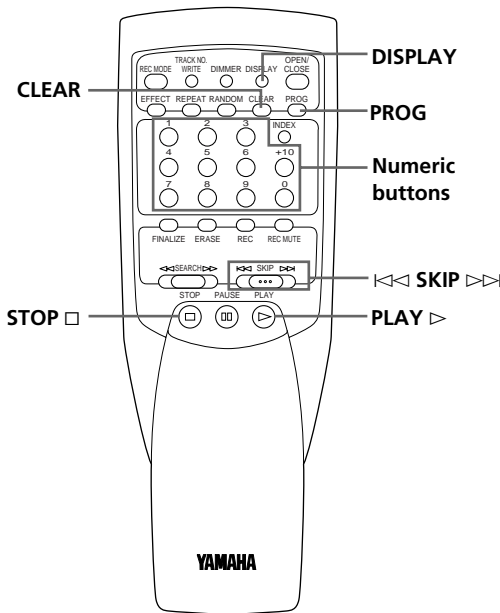
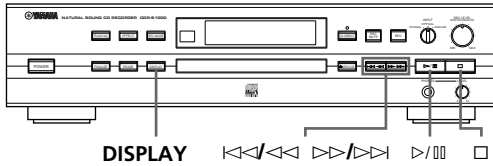

## Display information during programming

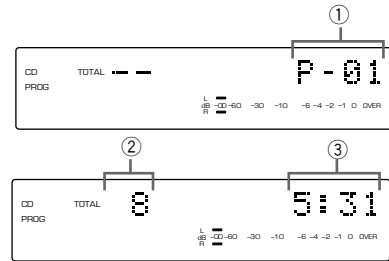

- ① Shows the step number for the track to be programmed next.
- ② Shows the programmed track number.
- ③ Shows the total time of the tracks currently programmed. If the total time exceeds 100 minutes, only the last two digits of the total minutes will be displayed.

### Notes

- You can program as many as 40 tracks at one time.
- If **DISPLAY** is pressed during programming, the program number display can be changed to display the total time of the programmed tracks. To return to the previous display, press **DISPLAY** again.
- During program play, pressing a numeric button on the remote stops program play and skips to the beginning of the track of the number pressed. Once that track has finished playing, the previously interrupted program resumes play.
- To skip tracks within the program, press <<</>>> or >>>/>>> (**SKIP** <<< or **SKIP** >>> on the remote) during program play.
- To search all tracks including unprogrammed tracks, press and hold <<</>>> or >>>/>>> (**SEARCH** <<< or **SEARCH** >>> on the remote) during program play.

- 1 Press **PROG** on the remote to begin programming.

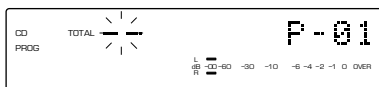

- The **PROG** indicator lights in the display.
  - If “P-01” does not appear in the display after **PROG** on the remote is pressed, press **DISPLAY** repeatedly until it appears in the display.
- 2 Program the tracks in the order you want by pressing the corresponding numeric buttons on the remote.
  - 3 When the programming is completed, press >/00 (**PLAY** > on the remote) to start programmed play.

## To check program data

1. During program play, press  $\square$  (**STOP**  $\square$  on the remote).
2. Press **PROG** on the remote.
3. Each time  $\triangleright\triangleright/\triangleright\triangleright$  (**SKIP**  $\triangleright\triangleright$  on the remote) is pressed, the programmed track numbers and their order in the program can be checked one after another. Each time  $\triangleleft\triangleleft/\triangleleft\triangleleft$  (**SKIP**  $\triangleleft\triangleleft$  on the remote) is pressed, the programmed track numbers and their order in the program can be checked in reverse sequential order.

## To correct program data

1. Follow steps 1 and 2 described in the above procedure "To check program data".
2. Display the track number to be corrected by pressing  $\triangleleft\triangleleft/\triangleleft\triangleleft$  or  $\triangleright\triangleright/\triangleright\triangleright$  (**SKIP**  $\triangleright\triangleright$  or **SKIP**  $\triangleleft\triangleleft$  on the remote).
3. Press a numeric button on the remote to select a track to replace the one displayed. The previously programmed track will be cleared from the memory and the new one will be programmed.
4. After the correction has been completed, press  $\triangleright/\square$  (**PLAY**  $\triangleright$  or **PROG**  $\square$  on the remote).

## To stop program play

Press  $\square$  (**STOP**  $\square$  on the remote). The first programmed track number will be displayed. To start program play again, press  $\triangleright/\square$  (**PLAY**  $\triangleright$  on the remote). Play will begin from the beginning of the program.

## To cancel a programmed sequence

Press  $\square$  (**STOP**  $\square$  or **CLEAR** on the remote) while the unit is stopped.

## Random sequence play

You can play all the tracks on a disc in a random sequence.

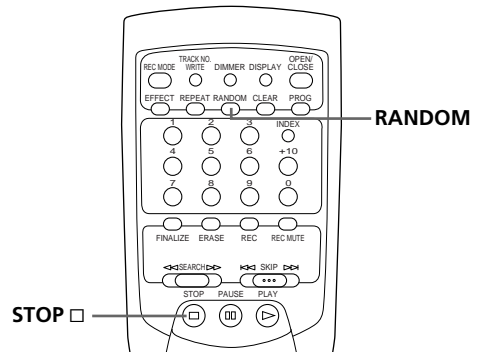

Press **RANDOM**.

The RNDM indicator appears in the display and the unit starts random sequence play.



## To cancel random sequence play mode

Press **STOP**  $\square$  or **RANDOM**.

- The RNDM indicator disappears from the display.

## Notes

- This feature will not function during programming, or during programmed play.
- If **SKIP**  $\triangleright\triangleright$  is pressed during random sequence play, the next randomly selected track will be played. If **SKIP**  $\triangleleft\triangleleft$  is pressed, play will return to the beginning of the current track. It is not possible to return to previously played tracks during random sequence play mode.
- Total remaining time on the disc will not be displayed during random sequence play.

## Repeat play

You can play a single track or the entire disc repeatedly.

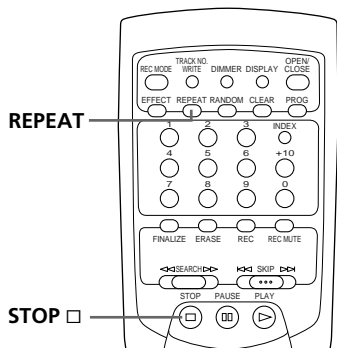

### SINGLE REPEAT (REPEAT S)

Press **REPEAT** until the indicators REPEAT and S appear in the display.

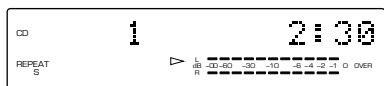

The current track is played repeatedly.

- This is also available in the program play mode and the random sequence play mode. (If the repeat play mode is switched off, the program play mode or the random sequence play mode will be resumed.)

### FULL REPEAT (REPEAT F)

Press **REPEAT** until the indicators REPEAT and F appear in the display.



All the tracks on a disc are repeated.

- In the program play mode, all programmed tracks are repeatedly played.
- In the random sequence play mode, all randomly sequenced tracks are played repeatedly.

### To cancel repeat play

Press **REPEAT** until the REPEAT indicator disappears from the display.

## Index search

If the disc includes index numbers, play can be started from any desired index number.

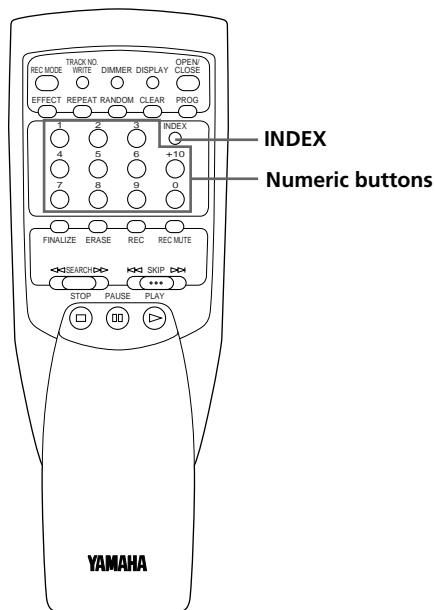

### To select an index number

- 1 Use the numeric buttons to select a track that has index numbers.
- 2 Press **INDEX**.
- 3 Use the numeric buttons to select the desired index number.

### To cancel the index search function

Press **INDEX**.

### Notes

- Not all discs have index numbers. The index system has a method for sub-dividing tracks into smaller divisions (for example, the movements within classical symphonies) for easier location of those parts. The liner notes with the disc usually tell if such index numbers are included.
- If an index number is selected that is higher than any index number on that disc, play will start from the last index number point on the disc.
- For some discs, play may begin slightly prior to the actual designated index point.
- If the disc has no encoded index points, play will begin from the start of the selected track.

## Changing the brightness of the display

You can select the brightness level of the display as it suits your preferences.

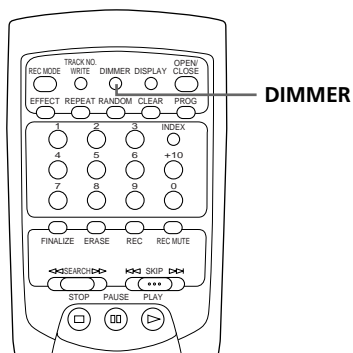

The brightness of the display is changed each time **DIMMER** is pressed as follows.

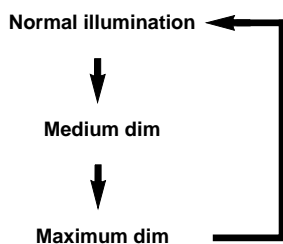

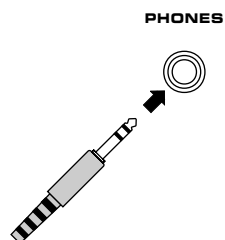
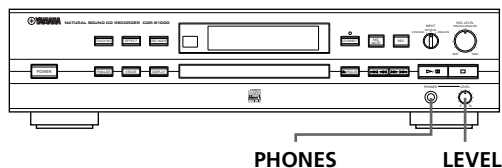

## Listening with headphones

Connect the headphones to the **PHONES** jack and adjust the volume by using **LEVEL**.



**CD preventive care**

- This compact disc recorder is designed for use with compact discs bearing the , , or  marks only. Never attempt to load any other type of disc into the unit.

The unit will also play 8-cm (3-inch) compact discs.

- Compact discs are not subjected to wear during play, but damage to the disc surface when the disc is being handled can adversely affect the disc's play.
- Do not use cleaning discs or warped discs. All of these could damage the unit.

**To prevent a malfunction of this unit**

- Do not use any non standard shaped CD discs (heart, etc.) available on the market, because it may damage the unit.

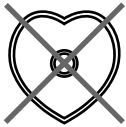

- Do not use a CD disc with tape, seals, or paste on it, because damage to the unit may result.
- Be sure to use a felt-tip pen or similar writing tool when writing on the label side of the disc. Do not use a ball-point pen, pencil, or other hard-tipped writing tool, as these may damage the disc and may adversely affect further recording on the disc.

- Although playback of compact discs is generally not affected by small particles of dust or fingerprints on their playing surface, dust, fingerprints, small scratches and direct sunlight on the recording surface of a CD-R or CD-RW disc may make recording impossible. Therefore, for optimal performance of the recorder and for long-term enjoyment of your CD collection, handle discs correctly as outlined in the following guidelines.

- Hold discs by touching only the edges or center hole.
- When a disc is not currently being used, remove it from the recorder and store in an appropriate case.
- With proper disc maintenance, cleaning should not be necessary. However, should cleaning be required, wipe by using a clean, dry cloth. Do not wipe with a circular motion; wipe straight outward from the center.

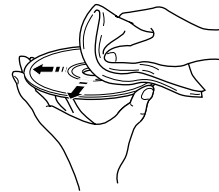

- Do not try to clean the disc's surface by using any type of disc cleaner, record spray, antistatic spray or liquid, or any other chemical-based liquid, because such substances might irreparably damage the disc's surface.
- Do not expose discs to direct sunlight, high temperature or high humidity for a long period of time, because these might warp or otherwise damage the disc.

**No!**



## Display messages

### Can't Copy

Digital recording cannot be performed. (See "SCMS copy protection" on page 32.)

### Disc Full

Recording is not possible because there is no blank space remaining on the disc.

### Track Full

Recording is not possible because the maximum number of 99 tracks has already been recorded on the disc.

### Not Audio

The inserted disc is not an audio CD-R or CD-RW disc.

### OPEN

The disc tray is being opened.

### CLOSE

The disc tray is being closed.

### Standby

The recorder has been put in the record pause mode from either the stop or record mode, and information is being written to the disc's PMA (Program Memory Area). Never turn the power off when this is displayed.

### Wait

The recorder has been put in the stop mode from the record mode and information is being written to the PMA (Program Memory Area). Never turn the power off when this is displayed.

### Erase LAST?

Erases the last track on a CD-RW disc.  
If you want to erase the last track, press ▷/00 (PLAY ▷ on the remote).

### Erase ALL?

Erases all tracks on a CD-RW disc.  
If you want to erase all tracks, press ▷/00 (PLAY ▷ on the remote).

### Check Disc

This is displayed when the recorder stops after reading disc information, while performing an erase procedure, finalization, or OPC. If this occurs, the disc may be dirty or possibly even damaged. Remove the disc and inspect it.

### Data Track

This is displayed when the data track is played back.

### Erase DISC?

Erases all of the information a CD-RW disc.  
If you want to erase all of the information, press ▷/00 (PLAY ▷ on the remote).

### Erase TOC?

Erases the TOC (Table Of Contents) on a CD-RW disc.  
If you want to erase the TOC, press ▷/00 (PLAY ▷ on the remote).

### Finalize OK?

Finalizes the CD.  
If you want to finalize the disc, press ▷/00 (PLAY ▷ on the remote).

### Finalized

Recording has been attempted on a CD-RW disc that has already been finalized.

### No Input

The digital input is selected, but the connections are not correct, or the digital signal is not being output from the source device. Please check all cabling, and the status of the source device.

### Reading

When the recorder is turned on or a disc is loaded, the recorder reads the format of the disc loaded in the recorder.

### OPC Adjust

Adjustments performed when OPC (Optimum Power Calibration) optimizes the laser power to the reflectivity of the disc. Some time is required to complete these automatic adjustments.

### No Disc

There is no disc in the disc tray.

### New Disc

The disc in the disc tray is either a new CD-R or CD-RW disc or a CD-RW disc that has been erased using the Erase ALL or Erase DISC function.

### TOC

During the finalization process, the TOC (Table Of Contents) is being written onto the disc.

## Troubleshooting

If the unit fails to operate normally, check the following points to determine whether the fault can be corrected by the simple measures suggested. If it cannot be corrected, or if the fault is not listed in the SYMPTOM column, disconnect the power cord and contact your authorized YAMAHA dealer or service center for help. When talking to the service center, the CDR-S1000 may be needed. For details, contact your authorized YAMAHA dealer or service center.

SYMPTOM	CAUSE	REMEDY
<b>The unit does not switch on when POWER is pressed.</b>	The AC power cord is not connected or not completely connected.	Securely connect the power cord.
<b>Play does not begin.</b>	The disc is damaged.	Check the disc carefully; replace it if necessary.
	There is moisture on the laser pick-up.	Wait 20 to 30 minutes after switching the unit on before trying to play a disc.
	The disc has been loaded upside down.	Reload the disc with the label side facing up.
	The disc is dirty.	Clean the disc.
<b>Play is delayed, or begins at the wrong place.</b>	The disc may be scratched or damaged.	Check the disc carefully; replace it if necessary.
<b>Recording is not possible.</b>	The disc is finalized.	Load a recordable CD that has not been finalized yet. For a CD-RW disc, TOC Erase or Disc Erase may be needed.
	A pre-mastered CD disc is loaded.	Load a recordable CD disc.
	The input setting is incorrect.	Set <b>INPUT</b> to the position that reflects the source of the input signal.
	The output level of the source is too low.	Set the output level of the source to MAX.
	There is not enough blank space left or 99 tracks have already been recorded on the disc.	Load a recordable CD disc.
	If the power cord was unplugged or there was a power outage during recording, the recorded material may be lost.	If the recording of a CD-RW disc is interrupted, try recording again from the beginning. When the recording of a CD-R disc is interrupted, start recording over again with a disc that can be recorded on.
	The disc is dirty or damaged.	Clean or replace the disc.
<b>Cannot play back a recorded CD-R or CD-RW disc on other CD or DVD players.</b>	The CD or DVD players are not compatible with CD-R or CD-RW discs.	Use a CD or DVD player compatible with CD-R or CD-RW discs.
	The disc is not finalized.	Finalize the disc.
<b>Sound "skips."</b>	The unit and/or the component being recorded is being subjected to vibration or impact.	Relocate the unit(s). This is not possible if the skipping sound is already on the recording due to vibrations or impact that occurred during recording.
	The disc is dirty.	Clean the disc.
<b>Sound "hums."</b>	Improper cable connections.	Securely connect the audio cables. If the problem persists, the cables may be defective.
<b>Noise from inside of the unit.</b>	The disc may be warped.	Replace the disc.
<b>The remote control does not work.</b>	The batteries of the remote control are too weak.	Replace the batteries with new ones.
	Remote control is too far away or is being used at an incorrect angle.	Use within 6 meters and 60 degree radius.
	Direct sunlight or lighting (of an inverter type of fluorescent lamp, etc.) is striking the remote control sensor of the unit.	Change the position of the unit.
<b>TV functions strangely when the remote control is being used.</b>	Remote control is being used near TV set with a remote control sensor.	Relocate this unit away from the TV or cover the TV's remote control sensor.

## SCMS copy protection

As a digital audio component, this CD recorder conforms with the Serial Copy Management System (SCMS) standards. The Serial Copy Management System restricts copies made by recording digital signals to first generation copies only. Therefore, a CD disc recorded using a **DIGITAL IN** jack cannot be used as a source for making another digital recording. However, subsequent recordings can be made from the first generation copy by using the **ANALOG** jacks.

There are three general rules that apply to this unit.

### Rule 1

You can record digital program sources onto a recordable CD disc using a **DIGITAL IN** jack to create a first generation digital copy. You cannot, however, record from this recorded CD disc to another recordable CD disc using a **DIGITAL IN** jack.

### Rule 2

You can record a digital signal input from a digital satellite broadcast onto a recordable CD disc using a **DIGITAL IN** jack. If the broadcast does not contain a copyright protection code, you can then record the contents of this recorded CD disc (first generation) onto other digital recording media to create a second generation digital copy (these copies may also be copied digitally). Note, however, that if the broadcast contains a copyright protection code, second generation digital copying will not be possible.

### Rule 3

A CD disc that was recorded using the **ANALOG** jacks can be recorded onto other digital recording media using a **DIGITAL OUT** jack to create a first generation digital copy. You cannot, however, make a second generation copy using a **DIGITAL OUT** jack.

## **CD-Recorder system notes and limitations**

### **About track length and number**

- The CD specifications state that the minimum length of a CD track must be 4 seconds. If a recording is stopped while the track is less than 4 seconds long, the unit will record silence until the 4 second track length requirement has been reached, and then stop recording.
- CD discs can be recorded with up to 99 tracks on them. Recording will be automatically stopped if the 99 track limit is exceeded. Once 99 tracks have been recorded, no further recording is possible even if time is remaining on the disc.

### **About source sampling rate conversion**

When recording an analog source (such as an LP or cassette), this unit converts the analog signals to a 44.1 kHz digital signal before recording them onto the CD-R or CD-RW disc.

When recording a digital source, this unit converts the digital signals to 44.1 kHz for recording onto the CD-R or CD-RW disc. However, if you are recording a 44.1 kHz source signal (such as another CD disc) there is no need for conversion. This unit can record 32, 44.1 and 48 kHz digital signals.

### **Recording of non-audio signals**

This unit is designed exclusively for recording audio signals. Non-audio signals from sources such as CD-ROM cannot be recorded. Recording is possible only when the input digital signal is an audio signal. Similarly, when a digital signal contains graphic or character information such as a CD+graphics or CD TEXT disc, the graphic or character information is not recorded.

### **When making digital recordings from DAT**

When recording from a DAT source, make sure that the start IDs on DAT tapes are in positions slightly before the actual audio begins.

DAT tapes that are originally recorded using the DAT recorder's auto ID function record the start ID slightly after the actual recording begins. Because this recorder uses the start ID on the DAT to indicate the transition between tracks, the following problems may occur during synchronized recording (single track or ALL track).

- The beginning of the audio on a track is not recorded.
- A new track number is created slightly after the beginning of a new track.
- The beginning of the next track is recorded at the end of a recording.

To avoid these potential problems, it is recommended to perform manual recording of DAT sources. For more information on DAT operations, refer to the operating instructions provided with the DAT recorder.

# Specifications

## Audio Performance

Frequency response	5 - 20,000 Hz, ±0.5 dB
S/N ratio	
Playback	107 dB
Recording	90 dB
Total harmonic distortion (1 kHz)	
Playback	0.004%
Recording	0.008%
Dynamic range	
Playback	100 dB
Recording	94 dB

## Laser Diode Properties

Material	GaAlAs
Wavelength	783 - 789 nm
Emission duration	Continuous
Laser output	Max. 44.6 μW*
ANSI Class	Class 1

\* This output is the value measured at a distance of about 200 mm from the objective lens surface on the Optical Pick-up Block.

## Inputs

LINE IN (REC)	
Type	Pin jack
Standard input level	500 mV/24 k-ohms
DIGITAL IN OPTICAL	
Type	Square optical connector jack
DIGITAL IN COAXIAL	
Type	Pin jack

## Outputs

LINE OUT (PLAY)	
Type	Pin jack
Standard output level (1 kHz, 0 dB)	2.0 ± 0.5 Vrms
DIGITAL OUT OPTICAL	
Type	Square optical connector jack
DIGITAL OUT COAXIAL	
Type	Pin jack
PHONES	
Standard output level (Input 150 ohms shorted, -20 dB)	300 mV/150 ohms

## General

Power supply	
[U.S.A. and Canada models]	AC 120 V, 60 Hz
[Australia model]	AC 240 V, 50 Hz
[U.K. and Europe models]	AC 230 V, 50 Hz
Power consumption	35 W
Dimensions (W x H x D)	
.....	435 x 108 x 400 mm (17-1/8" x 4-1/4" x 15-3/4")
Weight	6.3 kg (13 lbs. 14 oz.)
Accessories	
.....	RCA Pin Cables (2)
.....	Optical Fiber Cable
.....	Remote Control
.....	Batteries (2)

Specifications are subject to change without notice.



---

**YAMAHA ELECTRONICS CORPORATION, USA** 6660 ORANGETHORPE AVE., BUENA PARK, CALIF. 90620, U.S.A.  
**YAMAHA CANADA MUSIC LTD.** 135 MILNER AVE., SCARBOROUGH, ONTARIO M1S 3R1, CANADA  
**YAMAHA ELECTRONIK EUROPA G.m.b.H.** SIEMENSSTR. 22-34, 25462 RELINGEN BEI HAMBURG, F.R. OF GERMANY  
**YAMAHA ELECTRONIQUE FRANCE S.A.** RUE AMBROISE CROIZAT BP70 CROISSY-BEAUBOURG 77312 MARNE-LA-VALLEE CEDEX02, FRANCE  
**YAMAHA ELECTRONICS (UK) LTD.** YAMAHA HOUSE, 200 RICKMANSWORTH ROAD WATFORD, HERTS WD1 7JS, ENGLAND  
**YAMAHA SCANDINAVIA A.B.** J A WETTERGRENS GATA 1, BOX 30053, 400 43 VÄSTRA FRÖLUNDA, SWEDEN  
**YAMAHA MUSIC AUSTRALIA PTY, LTD.** 17-33 MARKET ST., SOUTH MELBOURNE, 3205 VIC., AUSTRALIA

**YAMAHA CORPORATION**

Printed in Japan  V483860-1