

YAMAHA

CT-610



AM/FM Stereo tuner

Owner's Manual

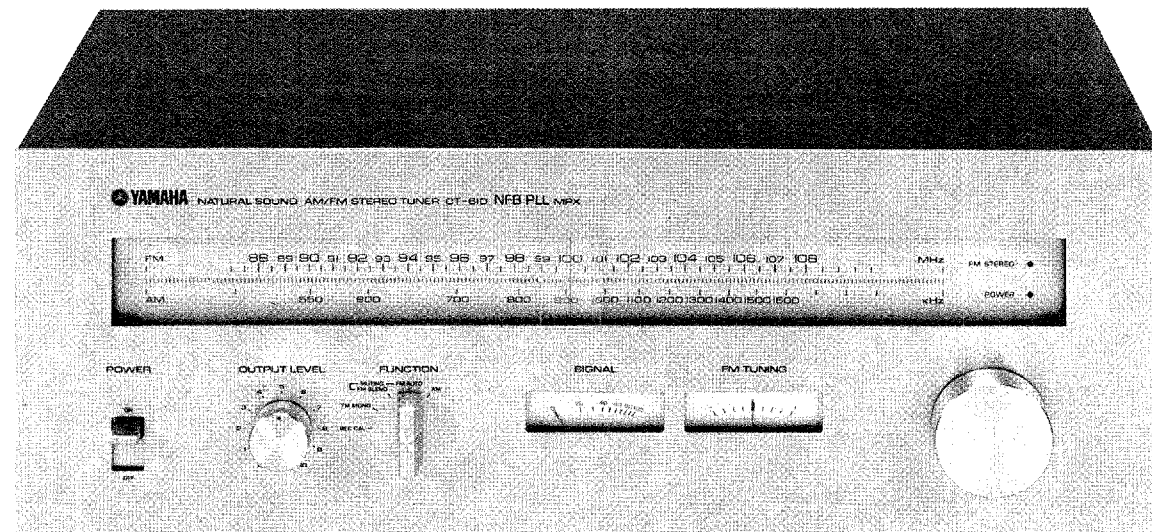
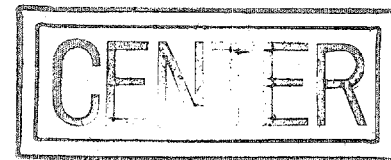

CT-610

CONTENTS AND FEATURES

YAMAHA offers you thanks and congratulations on your choice of the CT-610 AM/FM Stereo Tuner. Product of research directed at making the best possible audio performance available to the widest range of enthusiasts, the CT-610 is currently setting new standards for its class.

Front Panel and Controls	4
Rear Panel and Connections	5
Connecting and Operating the CT-610 with Other Components	6
Block Diagram and Specifications	10
Trouble Shooting	11

1. Audio Quality-First Design

Building on YAMAHA's unique audio and electronic engineering know-how, as developed for the top-of-the-line CT-7000, the CT-610 features low distortion, high sensitivity, and excellent S/N ratio.

2. High Performance Reception

Junction-type FET, three-gang tuning capacitor, six special ceramic filters, and six-stage constant bias current differential limiter assure superb radio reception.

3. High Fidelity Waveform Transmission

Low distortion (and therefore high audio quali-

ty) are the result of special YAMAHA integrate gain analysis, not only for all frequencies, but also over a wide range of input levels, from weak, distant stations, to powerful local stations.

4. NFB PLL MPX Stereo Demodulator Section

Negative Feedback (NFB) phase-locked loop (PLL) multiplex (MPX) circuitry has all been built into one high performance IC, replacing a host of individual components, for greater reliability, improved performance, and lowered cost.

5. Signal Meter with Quality Indication

Waves that reach the antenna after being reflected from nearby hills or buildings ('multipath'

waves) interfere with the main broadcast signal, and degrade performance. The CT-610 has a special circuit which detects these waves, and uses them to produce a 'waver' in the signal-strength indication. It is simple to turn the antenna for minimum variation, giving maximum quality.

6. Standard 333 Hz Signal for Level Setting

The REC CAL function gives a standard signal, ideal for recording calibration and optimum level setting. The variable level setting has a center click-stop for known rated output.

7. Muting Circuit for Quiet Inter-Station Traverse

8. Low Distortion AM Circuitry for Added Enjoyment

CT-610

CAUTION-READ THIS BEFORE OPERATING YOUR CT-610

1 The CT-610 is a high performance AM/FM stereo tuner with excellent selectivity, sensitivity, and several special features. This manual is required reading if you are to get the best from it.

2 Do not drop or otherwise jar the CT-610, which is a precision instrument.

3 Do not place the CT-610 where it will be exposed to direct sunlight, excessive heat (for instance over a radiator or on top of an amplifier which generates a fair amount of heat), moisture, or dust.

4 Do not use chemical solvents (such as benzene or alcohol) to remove traces of dirt. Wipe only with a soft, slightly damp cloth.

5 Do not attempt to carry out internal adjustments or repairs. Leave this to your local service representative.

6 Do not assume your CT-610 is faulty before checking the 'Trouble Shooting' list on page 11 for common operating errors.

7 Operate all switches and knobs in accordance with the instructions. Avoid applying undue force, which should never be necessary, and to not attempt to use intermediate settings.

8 Keep this manual in a safe place for future reference, and refer to it frequently until you are perfectly familiar with all CT-610 controls and functions.

9 If your CT-610 has a voltage selector, check that it is set to your local voltage before you plug in the AC supply.

If not properly set, unscrew the two switch-guard retaining screws, and reset the switch to indicate your supply voltage (110–130V, or 220–240V). Canadian models are set for 117V, 60 Hz alone, and have no voltage selector.

Be sure to replace the switch-guard and its two retaining screws after making the adjustment, inverting it so that the new voltage setting shows.

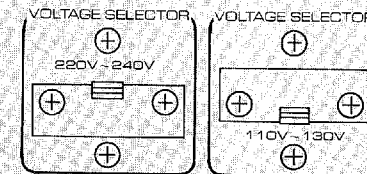

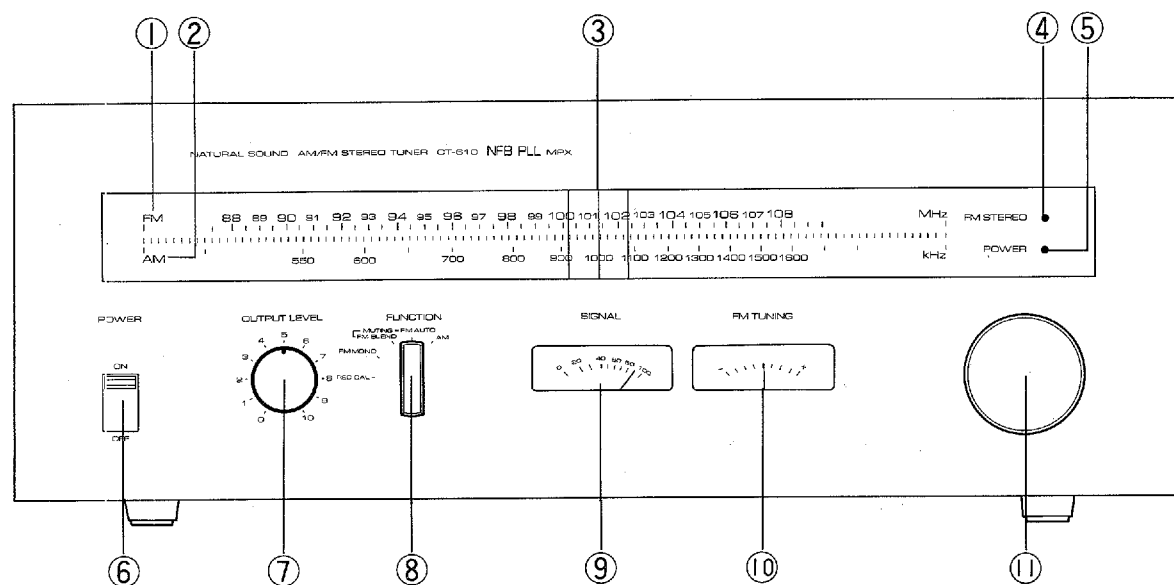

① FM Tuning Scale

This scale is frequency linear, so that stations are spread out evenly across the dial, not clumped together at one end. The units are MHz.

② AM Tuning Scale

This scale, marked clearly in kHz, is used when tuning in AM stations.

③ Tuning Indicator

This pointer indicates accurately the frequency of the station to be tuned in. The slide-ruler type pointer ensures high precision for rapid station location.

④ FM STEREO Indicator Lamp

This lamp illuminates when FM stereo broadcasts are being received. It goes out, however, if the FUNCTION selector is turned to the FM MONO setting.

⑤ POWER Indicator Lamp

This lamp illuminates when the POWER switch is in the ON position, indicating that electrical power has been connected. If it goes out, with the POWER switch still ON, this can mean that the power fuse has blown.

⑥ POWER Switch

Switch ON to connect the main electrical supply.

⑦ OUTPUT LEVEL Control

This sets the output level to suit the input requirements of your amplifier unit. Adjust it so that the volume setting of your amplifier does not need to be changed when switching from TUNER to other sources, such as PHONO or TAPE. The center click stop gives a calibrated output which is detailed in the Specifications.

⑧ FUNCTION Selector Switch

This selects whether FM or AM broadcasts are to be received, and if FM, then whether in MONO, STEREO, with HIGH BLEND and/or MUTING, and also offers a REC CAL position for tape recorder calibration.

⑨ SIGNAL Meter

This indicates the strength of the signal for both AM and FM station, and indicates FM multipath interference by fluttering, with the amplitude of the variation showing the extent of the interference.

⑩ FM TUNING Meter

This is used when tuning in FM stations: the indicator points to dead center when the station is perfectly in tune.

⑪ Tuning Knob

The tuning knob is large, and the precision tuning mechanism eliminates backlash, for smooth and positive station selection.

CT-610

REAR PANEL AND CONNECTIONS

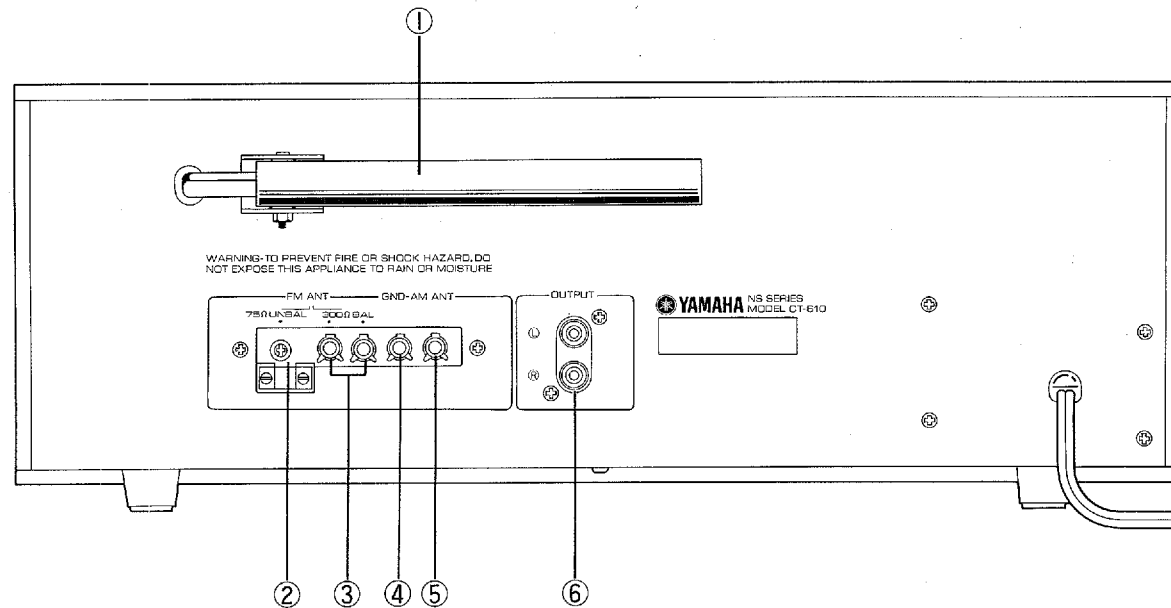

1 AM Bar Antenna

This rod is a special indoor antenna for AM reception. It should be folded out, away from the chassis of the CT-610, to get the best results. In most situations this bar antenna will give satisfactory reception, but in locations remote from the broadcasting station, or where the terrain (hills or mountains) or the environment (steel-frame buildings, etc.) are unfavorable, an external antenna may give noticeably better results.

2 FM ANT (75 Ω Coaxial Cable)

This special bracket and terminal is provided for use with 75Ω coaxial cable. Coaxial cable, in

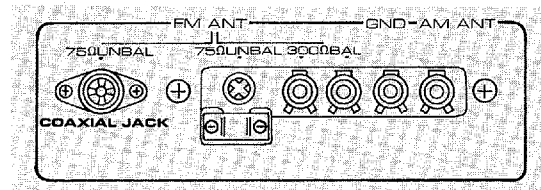

which the central core is shielded by an outer braided sheath, reduces losses in signal strength between the antenna and the CT-610, and also reduces the amount of interference picked up. Some models of the CT-610 are provided with a coaxial-plug jack in addition to the coaxial bracket and terminal, as shown.

3 FM ANT (300 Ω Balanced Feeder)

This is the pair of terminals used with ordinary twin type feeder wire, like that used in the indoor FM antenna provided with the CT-610. Although the high sensitivity of the CT-610 means that an indoor antenna can often give satisfactory results with local stations, a proper FM antenna will always give better results.

4 GND (Ground) Connection

Connection of a ground or 'earth' connection can make a worthwhile difference to AM reception, effectively increasing sensitivity and reducing interference, particularly hum.

5 AM ANT (External AM Antenna Terminals)

In areas where the bar antenna proves inadequate for satisfactory AM reception, or wherever reception of remote or low strength stations is required, an external antenna should be connected to this terminal.

6 OUTPUT Terminals

The output terminals of the CT-610 provide a fully variable signal, suitable for all types of pre-main amplifier or tape recorder. The level is set by the OUTPUT LEVEL control on the front panel.

CT-610

CONNECTING AND OPERATING THE CT-610 WITH OTHER COMPONENTS

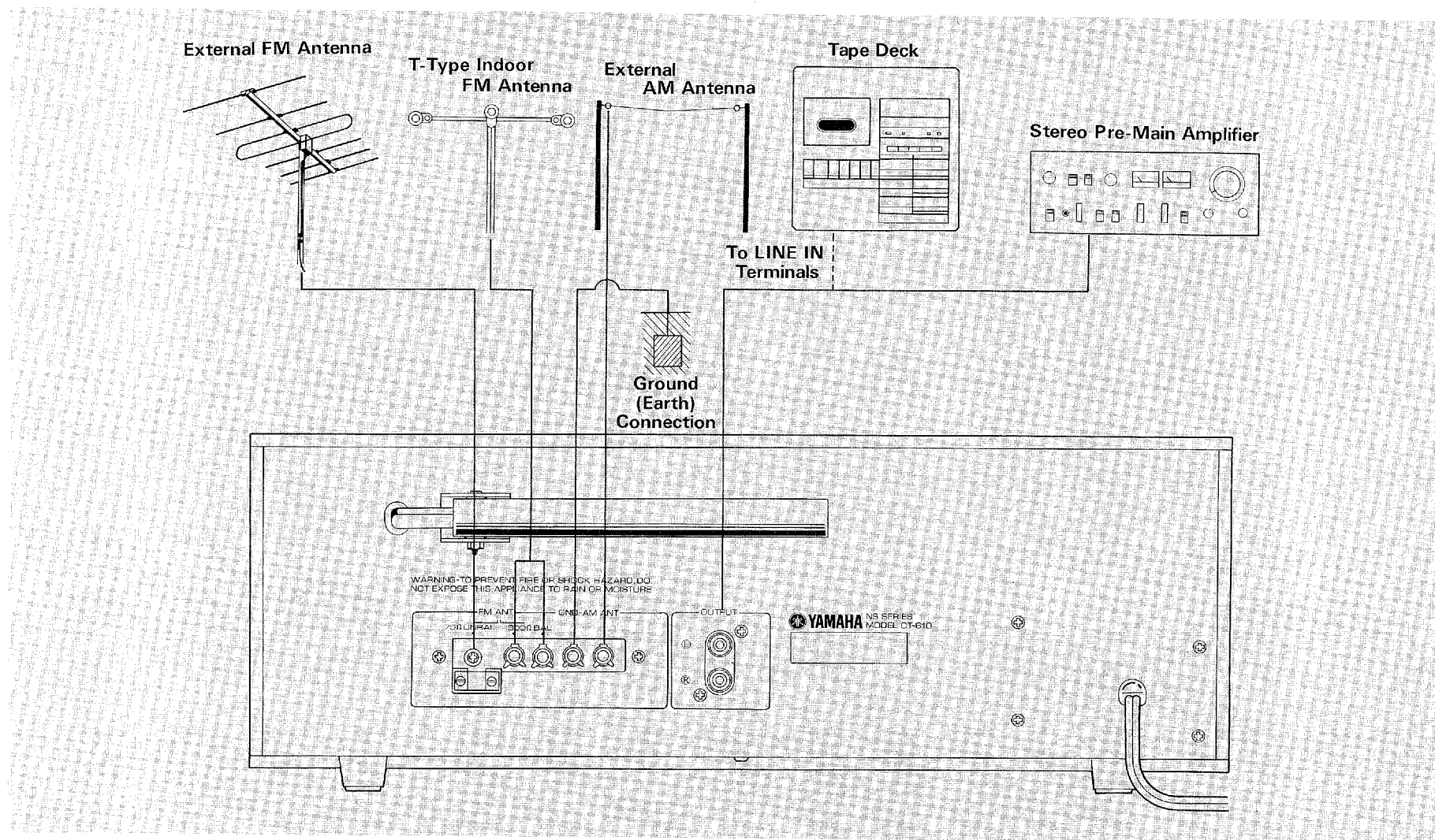

CONNECTIONS TO A STEREO AMPLIFIER

Use the pin-plug cables provided with the CT-610 to connect the OUTPUT terminals on the rear panel to the TUNER or AUX input terminals of your preamplifier or pre-main amplifier. Make sure that you connect the LEFT (upper) output terminal of the CT-610 to the left-channel input terminal, and the RIGHT to the right-channel.

Adjust the OUTPUT LEVEL control so that there is no significant change in volume when

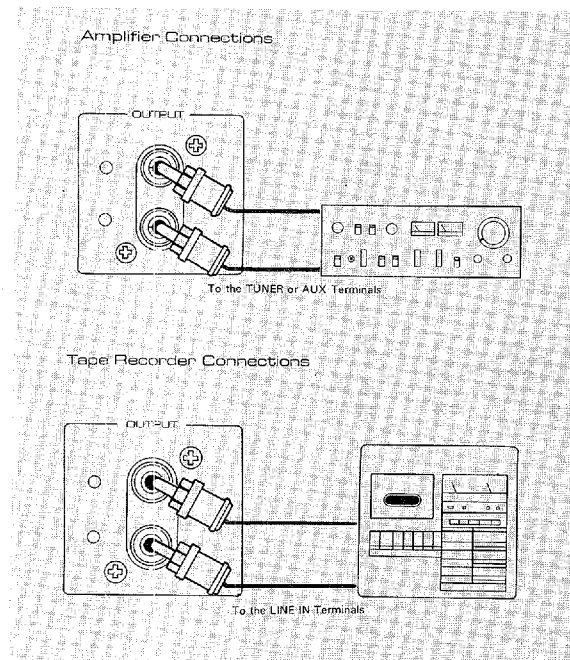

switching from TUNER to other sources (PHONO or TAPE) with your amplifier.

You can record directly from the CT-610 with a tape recorder: use pin-plug cables to connect the OUTPUT terminals to the tape recorder LINE IN terminals. Check that the LEFT (upper) output terminal is connected to the left-channel input terminal, and the RIGHT to the right-channel. See also the instructions for using the REC CAL setting of the FUNCTION switch, which can be particularly useful when recording direct from the CT-610.

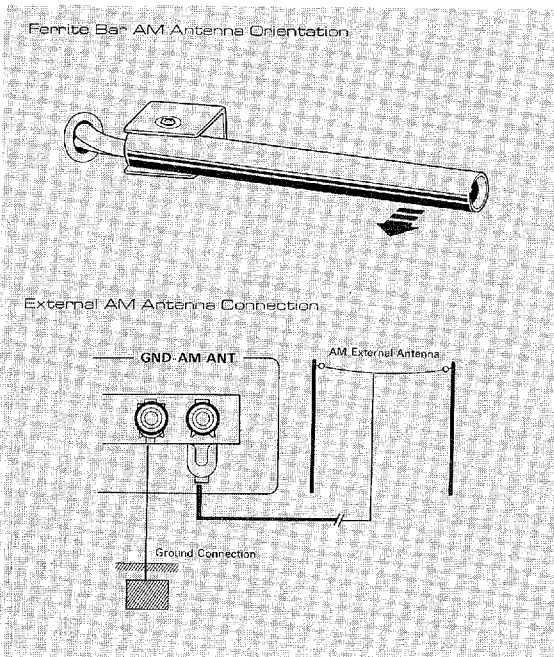

ADJUSTING THE AM BAR ANTENNA

The high efficiency ferrite bar antenna provided with the CT-610 is all that is required for satisfactory reception except in low signal strength areas, so that usually no external AM antenna will be needed. The bar antenna is hinged so that it can swing out: try swinging it while watching the SIGNAL strength meter. Set it at the angle which gives the maximum reading for the weakest station you will normally be listening to.

In a metal-frame building, or in locations remote from the station or where reception conditions are unfavorable, an external AM antenna should be connected to the AM ANT terminal. Even better results will be obtained if at the same time a good ground (earth) connection is made. A good ground connection can sometimes be made to a water pipe. However, under NO circumstances should you attempt to make a ground connection to a gas pipe. Your dealer will advise you.

AM RECEPTION

- 1 Set the FUNCTION switch on the front panel to AM.
- 2 Turn the tuning knob until the tuning indicator is at the station's frequency.
- 3 Adjust the tuning knob to give the maximum reading on the SIGNAL meter.
- 4 Note that the TUNING meter does not work for AM.

CONNECTING AN FM ANTENNA

First, connect the T-type internal (indoor) antenna provided with the CT-610 to the 300 Ω BAL Terminals on the rear panel. The two arms of the 'T' should be tacked at full stretch to the ceiling or walls of your room. Try them in different positions, and choose that which gives the best reception for the weakest station to which you will normally be listening. If you cannot obtain satisfactory reception even varying the angle of the horizontal T through a full 180°, this is an indication that you need an external FM antenna.

The T-type antenna is adequate only in high signal strength areas under favorable conditions. In all other cases, an external multi-element FM antenna is needed. To ensure the very best results, a motor driven antenna assembly with remote control of orientation is best, but the CT-610 has

sufficient sensitivity to operate extremely well with a fixed antenna.

External antennas are available for use with the 300 Ω and 75 Ω terminals: the latter will use the shielded coaxial cable which reduces losses and interference. Antennas intended for 300 Ω balanced feeder wire can also be used with 75 Ω coaxial cable, but a matching transformer is necessary at the antenna. Coaxial cable should be used where the antenna must be located some way from the CT-610, or where interference from automobile ignition, etc., is troublesome.

The external antenna should be located as close as convenient to the CT-610, and as high as possible. It should be oriented to give the highest SIGNAL meter reading possible for the weakest station you will normally be listening to. If this direction is not too critical, you can orient the antenna for minimum interference from automobile ignition, etc.

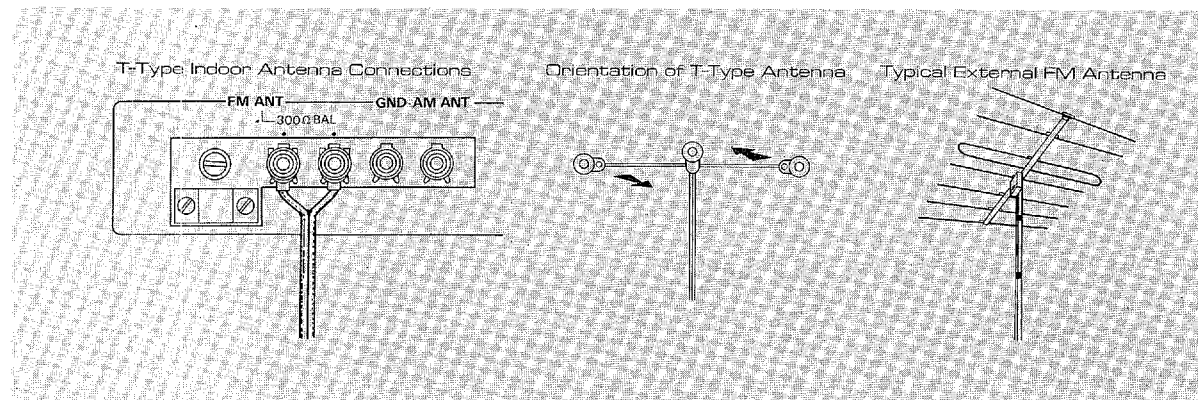

CONNECTING COAXIAL CABLE

- 1 Strip insulation from outside braided sheath, and bend back *outside* the insulation. Expose the projecting central core wire as shown.
- 2 Slacken the two retaining screws, insert the coaxial cable, and re-tighten the screws so that the clip grips the exposed braided sheath.
- 3 Connect the central core wire to the 75 Ω terminal.
- 4 If your CT-610 is provided with a coaxial jack, use this with a coaxial plug on the 75 Ω coaxial cable. Whether you use plug or terminal, ensure that the braiding does not come into contact with the inner core.

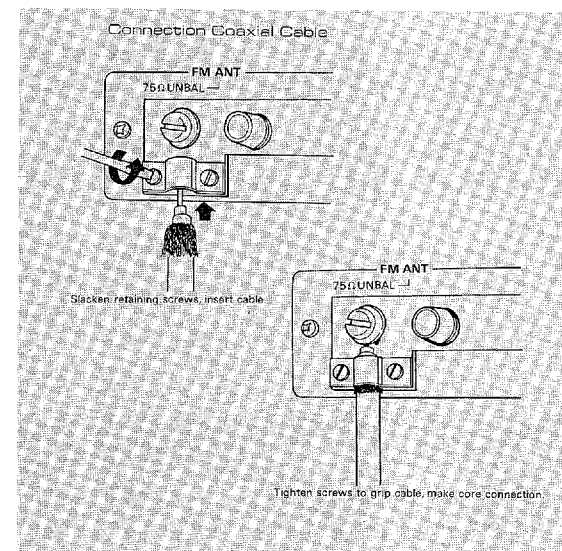

FM BROADCAST RECEPTION

- 1 Set the FUNCTION switch on the front panel to FM AUTO.
- 2 Turn the tuning knob until the tuning indicator is at the station's frequency.
- 3 Adjust the tuning knob to give the maximum reading on the SIGNAL meter, and to bring the FM TUNING meter pointer to the exact center position. This will ensure optimum tuning.
- 4 When the broadcast is in stereo, the STEREO indicator lamp will light, and will automatically go out when MONO broadcasts are being made.

FM BLEND POSITION

When you are listening to a weak FM station in stereo, there can be unpleasant high frequency noise (a kind of 'hiss'). If this hiss noise is

bothering you, switch to the FM BLEND position, which cuts out the noise very effectively. By switching to the MONO position this kind of noise can be reduced still further, but of course you will no longer be able to enjoy stereo reproduction.

REC CAL POSITION

In this position, instead of broadcast reception, the CT-610 output will consist of a 333 Hz signal corresponding to 50% modulation. When using a tape deck to record from the CT-610, the OUTPUT LEVEL control and tape recorder input level controls should be adjusted to give a level of -6 VU on the tape deck level meters. This can be increased to -2 VU depending on the tape deck and the kind of tape being used. Once you have determined the ideal setting for your tape deck, the REC CAL position enables you to find it again quickly and conveniently.

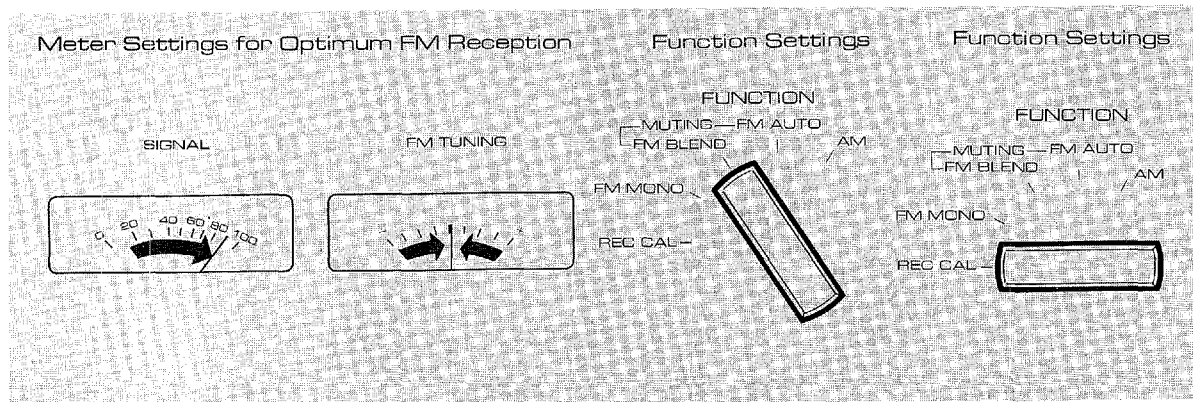

MULTIPATH DETECTION

So-called 'multipath' waves, reflected from nearby hills or tall buildings, can seriously degrade tonal quality in FM reception. In addition to the obvious deterioration in tonal quality, the SIGNAL meter can also give you an indication of the existence of multipath waves: it will show slight fluctuations. If you notice this, alter the orientation of your antenna to give a steady meter reading. You will enjoy generally better tonal quality even if this level is a little lower than the maximum when indication is fluctuating.

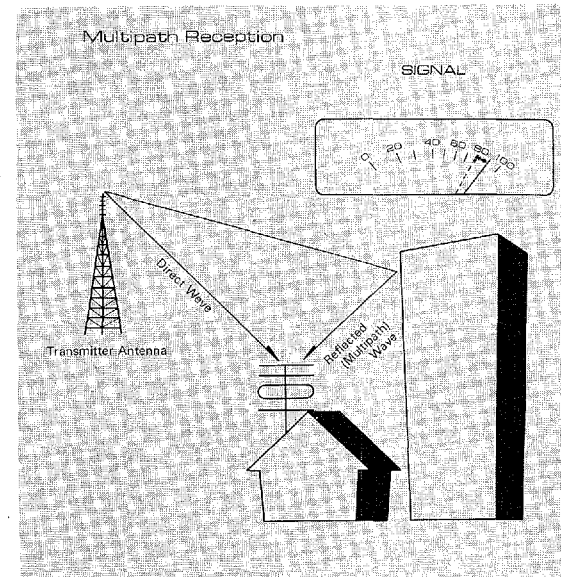

CT-610

BLOCK DIAGRAM AND SPECIFICATIONS

BLOCK DIAGRAM

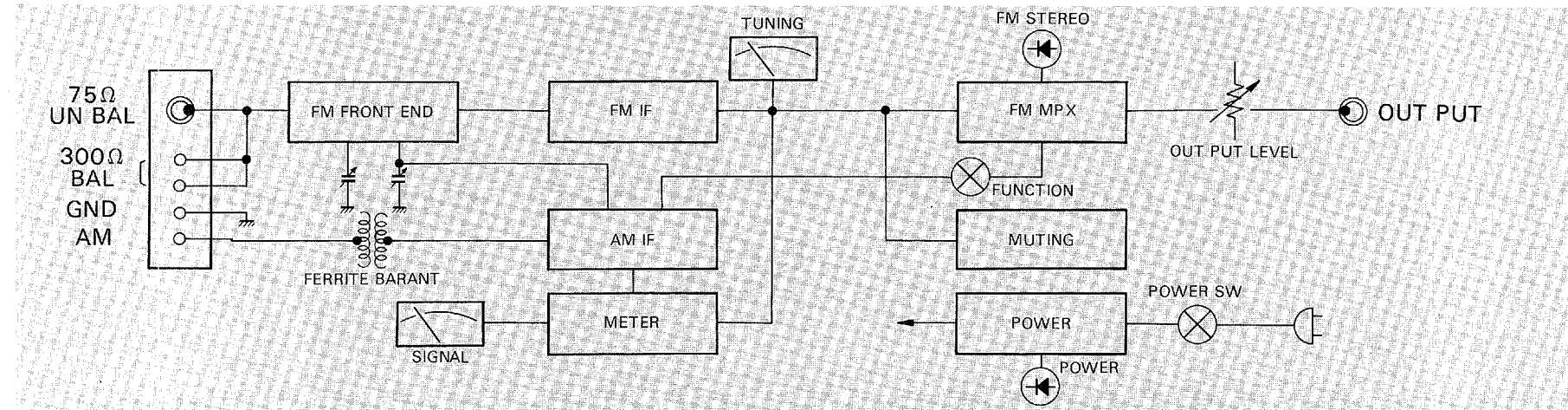

SPECIFICATIONS

FM Section

Tuning range	88 to 108 MHz
Sensitivity (IHF, 38 MHz)	1.8 μ V (300 Ω) 0.9 μ V (75 Ω)

Quieting Characteristic	
5 μ V	55 dB
10 μ V	60 dB

Image rejection (88 MHz)	55 dB
IF rejection (88 MHz)	75 dB
Spurious rejection	75 dB
AM suppression	56 dB
Capture ratio	1.0 dB
Selectivity (IHF)	75 dB

Signal/noise ratio	
Mono	77 dB
Stereo	71 dB

Total harmonic distortion	
Mono	
400 Hz	0.15%
50 Hz to 10 kHz	0.3%
Stereo	
400 Hz	0.25%
50 Hz to 10 kHz	0.8%

Sub-carrier suppression	40 dB
Stereo separation	
400 Hz	40 dB
50 Hz to 10 kHz	30 dB
Frequency response	50 Hz to 10 kHz ± 0.5 dB 20 Hz to 15 kHz ± 0.5 dB
Muting signal level	5 μ V
Multipath indication	Signal meter fluctuation (reduction in indicated level)

AM Section

Tuning range	525 to 1605 kHz
Sensitivity (IHF, bar antenna)	52 dB/m
Selectivity (1000 kHz)	25 dB
Signal/noise ratio (80 dB/m)	50 dB
Image rejection (1000 kHz)	50 dB
IF rejection (1000 kHz)	40 dB
Spurious rejection (1000 kHz)	45 dB
Total harmonic distortion (80 dB/m)	0.6%

Audio Section

Output level/Impedance (1 kHz)	
FM (400 Hz, 100% mod.)	0.1V to 1.0 V/2.5 k Ω
With level centered	500 mV/2.5 k Ω
AM (400 Hz, 30% m od.)	25 mV to 250 mV/2.5 k Ω
With level centered	125 mV/2.5 k Ω
REC. CAL. signal 333 Hz	50 mV to 500 mV/2.5 k Ω
With level centered	250 mV/2.5 k Ω
(corresponding to 50% FM modulation)	

General

Semiconductors used	22 Transistors, 3 ICs, 1 FET, 10 Diodes, 4 Zener Diodes, 2 LEDs, and 6 FM ceramic filters.
Power supply	120 V, 60 Hz USA & Canada 220-240/110-130 V, 50/60 Hz Europe
Power consumption	7 Watts
Dimensions (W x H x D)	435 x 160 x 349 mm (17-1/8" x 6-1/4" x 13-3/4")
Weight	6 kg (13.2 lbs)

CT-610

TROUBLE SHOOTING

Before assuming that your CT-610 is malfunctioning, check the following trouble-shooting list, which details corrective action you can take yourself, without having to call a service representative.

	Fault	Cause	Cure
AM Broadcast Reception	A persistent 'hum' occurs when the station is tuned in.	Known as modulation hum, this can affect whole areas where reception conditions are unfavorable.	In certain areas this cannot be eliminated, but sometimes changing the CT-610's position will give an improvement.
	Intermittent crackling or continuous background 'roaring.'	Atmospheric electricity or electrical storms, possibly fluorescent lighting or other electrical equipment.	Difficult to eliminate, an external antenna and good ground connection will give considerable improvement.
	High pitched whistles, etc., particularly at night.	Signals from adjacent stations are interfering with reception.	Nothing can be done to cut out this interference, but try turning down the TREBLE control.
		The CT-610 is being operated alongside a TV set.	Increase the distance between the TV and CT-610.
FM Broadcast Reception	Occasional crackling interference (particularly with remote, weak signal stations)	Electrical noise from automobile or motor cycle ignition systems.	Set up an external FM antenna, located as high and as far from the road as convenient, and use coaxial cable feeder.
		Interference from other electrical equipment, particularly thermostats.	Fit an interference suppressor to the offending item of electrical equipment.
	Noisy interference becomes particularly marked for stereo broadcasts, and spoils enjoyment.	FM stereo broadcasts are inherently more liable to this at remote, low signal strength locations.	Set up an external FM antenna If you are already using an external FM antenna, increase the number of elements in the antenna array. Listen at the BLEND setting.
	The FM STEREO indicator flickers when listening to stereo broadcasts.	Signal input from the antenna is too weak.	Use an external FM antenna suitable to your local signal strength.
		You are not perfectly tuned in to the station.	Tune in correctly (see the section on FM Broadcast Reception).
	Reception suffers from unclear, distorted sound, although an external FM antenna is being used.	Signal input from the antenna is too strong.	Connect an attenuator between the antenna and the CT-610. Try reverting back to the T-type FM internal antenna provided.
	During stereo test transmissions, sound which should come from only one channel can be heard faintly from the other.	This is known as crosstalk, and normally occurs to some extent.	Provided the 'leakage' of one channel into the other is very small compared with the normal level for that channel, this does not constitute a fault.



SINCE 1887  **YAMAHA**
NIPPON GAKKI CO., LTD. HAMAMATSU, JAPAN