

# YAMAHA AX-890

*Natural Sound Stereo Integrated Amplifier*

*Préampli/ampli de puissance stéréo de la série "Natural Sound"*

*Natural Sound Stereo-Verstärker*

*Natural Sound Integrerad Stereo Förstärkare*

*Amplificatore integrato stereo a Suono Naturale*

*Amplificador integrado estéreo de Sonido Natural*

*Natural Sound Geïntegreerde Stereo Versterker*

OWNER'S MANUAL  
MODE D'EMPLOI  
BEDIENUNGSANLEITUNG  
BRUKSANVISNING  
MANUALE DI ISTRUZIONI  
MANUAL DE INSTRUCCIONES  
GEBRUIKSAANWIJZING

**SUPPLIED ACCESSORIES**  
**ACCESSOIRES FOURNIS**  
**MITGELIEFERTES ZUBEHOR**  
**MEDFOLJANDE TILLBEHOR**  
**ACCESSORI IN DOTAZIONE**  
**ACCESORIOS INCLUIDOS**  
**BIJGELEVERDE ACCESSOIRES**

- After unpacking, check that the following parts are contained.
- Après le déballage, vérifier que les pièces suivantes sont incluses.
- Nach dem Auspacken überprüfen, ob die folgenden Teile vorhanden sind.
- Kontrollera efter det apparaten packats upp att följande delar finns med.
- Verificare che tutte le parti seguenti siano contenute nell'imballaggio dell'apparecchio.
- Desembale el aparato y verificar que los siguientes accesorios están en la caja.
- Controleer na het uitpakken of de volgende onderdelen voorhanden zijn.

- Remote Control Transmitter
- Emetteur de télécommande
- Fernbedienung
- Fjärrkontrollsändare
- Telecomando
- Transmisor del control remoto
- Afstandbediening

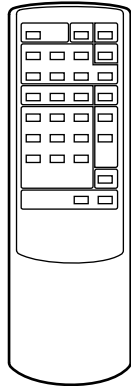

- Batteries (size AA, R6, UM-3)
- Piles (taille AA, R6, UM-3)
- Batterien (Größe AA, R6, UM-3)
- Batterier (storlek AA, R6, UM-3)
- Batterie (dimensioni AA, R6, UM-3)
- Pilas (tamaño AA, R6, UM-3)
- Batterijen (maat AA, R6, UM-3)

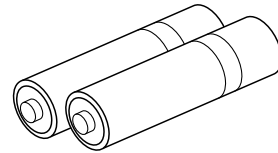

This product complies with the radio frequency interference requirements of the Council Directive 82/499/EEC and/or 87/308/EEC.

Cet appareil est conforme aux prescriptions de la directive communautaire 87/308/CEE.

Diese Geräte entsprechen der EG-Richtlinie 82/499/EWG und/oder 87/308/EWG.

Dette apparat overholder det gældende EF-direktiv vedrørende radiostøj.

Questo apparecchio è conforme al D.M.13 aprile 1989 (Direttiva CEE/87/308) sulla soppressione dei radiodisturbi.

Este producto está de acuerdo con los requisitos sobre interferencias de radio frecuencia fijados por el Consejo Directivo 87/308 CEE.

Dit product voldoet aan de EEG normen betreffende radio-frekwentie storingen 82/499/EEG en/of 87/308/EEG.

## FEATURES

- 110W + 110W (8Ω) RMS Output Power, 0.015% THD, 20–20,000 Hz
- High Dynamic Power, Low Impedance Drive Capability
- Continuously Variable Loudness Control
- CD DIRECT AMPLIFIER to Reproduce the Purest CD Sound
- PURE DIRECT Switch to Reproduce the Purest Source Sound
- SUBSONIC FILTER Switch to Cut Out Undesirable Ultra-Low-Frequency Signals
- PRE OUT/MAIN IN Terminals Useful for Connecting An Equalizer, Sound Processor, etc.
- Remote Control Capability

## CONTENTS

Supplied Accessories .....	2
Connections .....	4
Operations .....	6
Remote Control Transmitter .....	10
Notes about the Remote Control Transmitter .....	11
Troubleshooting .....	12
Specifications .....	13

## CAUTION: READ THIS BEFORE OPERATING YOUR UNIT.

1. To assure the finest performance, please read this manual carefully. Keep it in a safe place for future reference.
2. Install this unit in a cool, dry, clean place – away from windows, heat sources, sources of excessive vibration, dust, moisture and cold. Avoid sources of humming (transformers, motors). To prevent fire or electrical shock, do not expose the unit to rain or water.
3. Never open the cabinet. If something drops into the set, contact your dealer.
4. Do not use force on switches, controls or connection wires. When moving the unit, first disconnect the power plug and the wires connected to other equipment. Never pull the wire itself.
5. The openings on the cabinet assure proper ventilation of the unit. If these openings are obstructed, the temperature inside the cabinet will rise rapidly and eventually damage the circuits. Therefore, avoid placing objects against these openings and do not install the unit where the flow of air through the ventilation openings could be impeded.
6. Always set the VOLUME control to “– ∞” before starting the audio source play: increase the volume gradually to an appropriate level after the play has been started.
7. Do not attempt to clean the unit with chemical solvents; this might damage the finish. Use a clean, dry cloth.
8. Be sure to read the “TROUBLESHOOTING” section regarding common operating errors before concluding that the unit is faulty.
9. **When not planning to use this unit for long periods of time (ie., vacation, etc.), disconnect the AC power plug from the wall outlet.**
10. To prevent lightning damage, disconnect the AC power plug and disconnect the antenna cable when there is an electrical storm.
11. Grounding or polarization – Precautions should be taken so that the grounding or polarization of an appliance is not defeated.
12. AC outlet  
Do not connect audio equipment to the AC outlet on the rear panel if that equipment requires more power than the outlet is rated to provide.

### 13. Voltage Selector (General Model only)

The voltage selector on the rear panel of this unit must be set for your local main voltage BEFORE plugging into the AC main supply.

Voltages are 110/120/220/240 V AC, 50/60 Hz.

The apparatus is not disconnected from the AC power source as long as it is connected to the wall outlet, even if the apparatus itself is turned off.

### IMPORTANT

Please record the serial number of this unit in the space below.

Serial No.:

The serial number is located on the rear of the unit. Retain this Owner's Manual in a safe place for future reference.

### WARNING

TO REDUCE THE RISK OF FIRE OR ELECTRIC SHOCK, DO NOT EXPOSE THIS UNIT TO RAIN OR MOISTURE.

# CONNECTIONS

- Before attempting to make any connections to or from this unit, be sure to first switch OFF the power to this unit and to any other components to which connections are being made.
- When making connections between this unit and other components, be sure all connections are made correctly, that is to say L (left) to L, R (right) to R, “+” to “+” and “-” to “-”. Also, refer to the owner’s manual for each component to be connected to this unit.

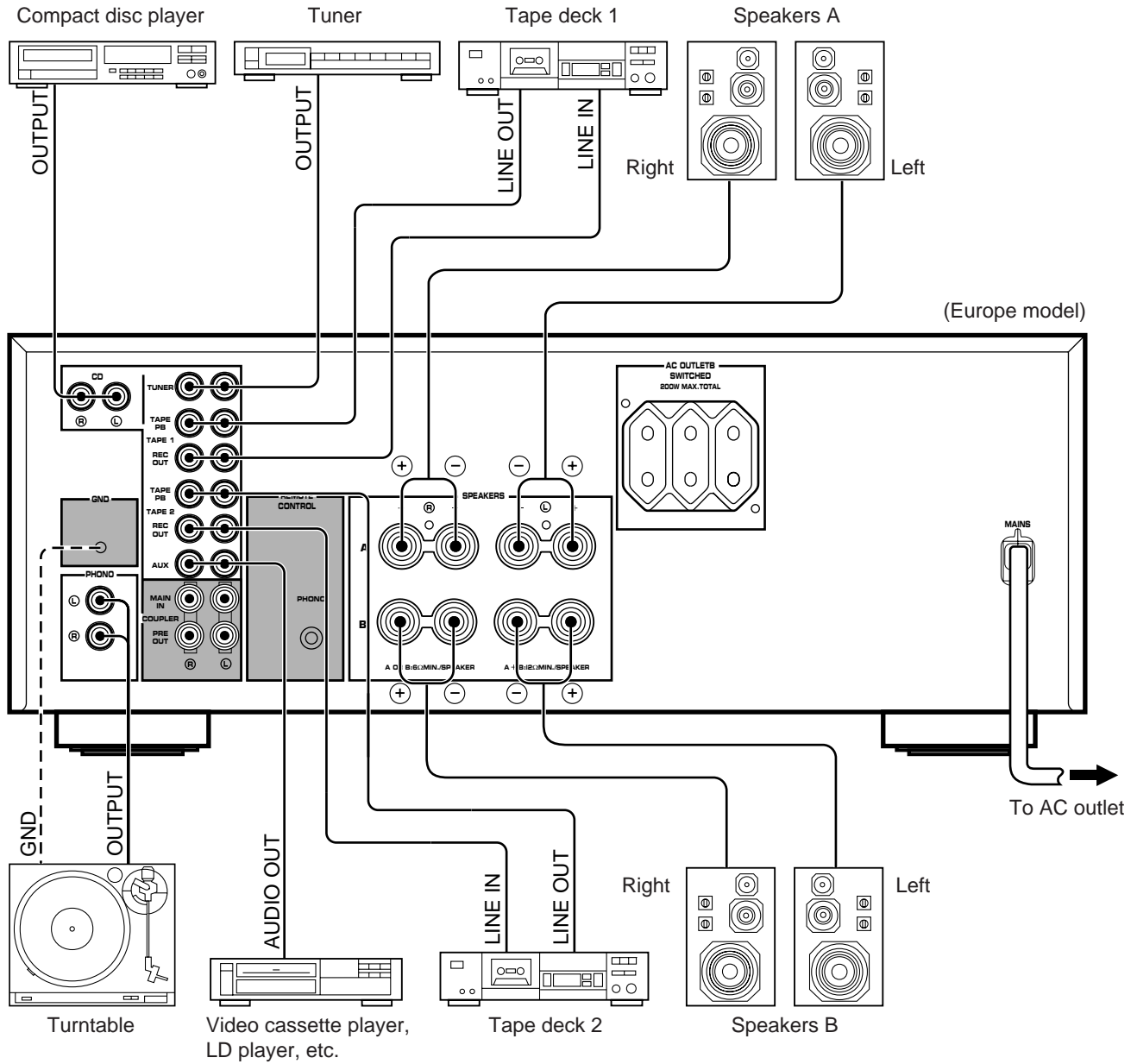

 : Refer to “**ABOUT THE OTHER REAR PANEL PARTS**” on page 5.

## AC OUTLETS (SWITCHED)

(Europe and General models)

.....3 SWITCHED OUTLETS

(Australia model) .....1 SWITCHED OUTLET

Use these to connect the power cords from your components to this unit.

The power to the **SWITCHED** outlets is controlled by this unit’s **POWER** switch or the provided remote control transmitter’s **POWER** key. These outlets will supply power to any component whenever this unit is turned on.

The maximum power (total power consumption of components) that can be connected to the **SWITCHED AC OUTLETS** is 200 watts.

## CONNECTING SPEAKERS

Connect the **SPEAKERS** terminals to your speakers with wire of the proper gauge, cut as short as possible. If the connections are faulty, no sound will be heard from the speakers. Make sure that the polarity of the speaker wires is correct, that is, + and – markings are observed. If these wires are reversed, the sound will be unnatural and will lack bass.

**Do not let the bare speaker wires touch each other and do not let them touch the metal parts of this unit as this could damage this unit and/or speakers.**

### How to Connect:

Red: positive (+)  
Black: negative (–)

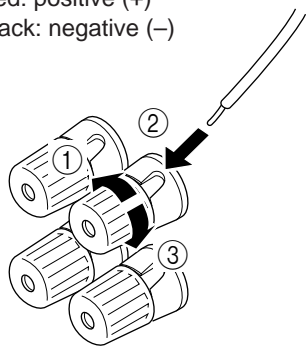

- ① Unscrew the knob.
- ② Insert the bare wire.  
[Remove approx. 5mm (1/4") insulation from the speaker wires.]
- ③ Tighten the knob and secure the wire.

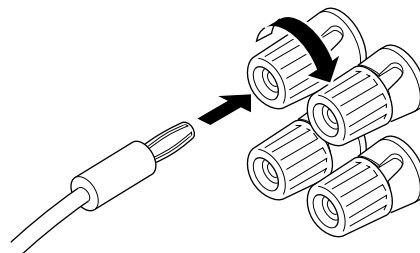

- One or two speaker systems can be connected to this unit. If you connect only one speaker system, connect it to either the **SPEAKERS A** or **B** terminals.
- Use speakers with the specified impedance shown on the rear of this unit.
- **<General and Australia models only>**  
Banana Plug connections are also possible. Simply insert the Banana Plug connector into the corresponding terminal.

## ABOUT THE OTHER REAR PANEL PARTS

### REMOTE CONTROL (PHONO) connector

If you have a YAMAHA turntable with a terminal for remote control, connect it to this connector by using the cable provided with the turntable. This connection allows you to control the turntable from the provided remote control transmitter.

### GND terminal (For turntable use)

Connecting the ground wire of the turntable to this terminal will normally minimize hum, but in some cases better results may be obtained with the ground wire disconnected.

### PRE OUT/MAIN IN terminals

Removing the jumper pins enables this unit to independently perform the functions of a control amplifier and a power amplifier. These terminals are for connection of a signal-processing system such as a graphic equalizer or sound processor.

If a sound processor or other external unit is connected between these terminals, the **VOLUME** control of this unit can be used for overall adjustment of the level of sound.

To connect such a unit, remove the jumper pins from the **PRE OUT/MAIN IN** terminals, connect the inputs of that unit to the **PRE OUT** terminals and its outputs to the **MAIN IN** terminals. For details, refer to the owner's manual included with the unit to be connected.

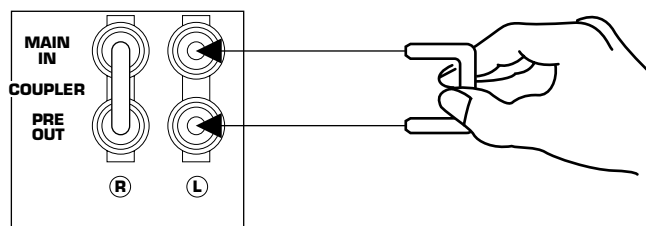

### Notes

- If you will not use the **PRE OUT/MAIN IN** terminals, never remove the jumper pins from these terminals. If removed, no sound will be output from this unit.
- If you will use this unit with an external unit connected between the **PRE OUT** and **MAIN IN** terminals, make sure that the **PURE DIRECT** switch on the front panel is turned off.
- If you will use this unit as a power amplifier, connect the outputs of an external control amplifier etc. to this unit's **MAIN IN** terminals. In that case, this unit's controls will not function except the **PHONES** jack and the **SPEAKERS** switches, so use the controls on the external control amplifier to make volume adjustment etc.

# OPERATIONS

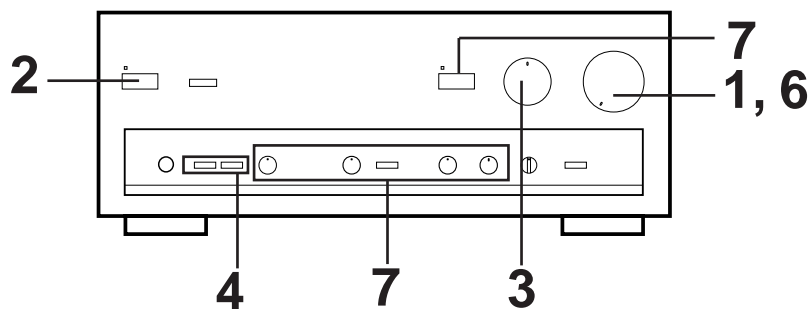

## TO PLAY A SOURCE

1

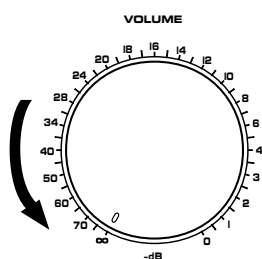

Set to the "∞" position.

2 Turn the power on.

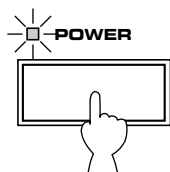

3 Select a desired input source.

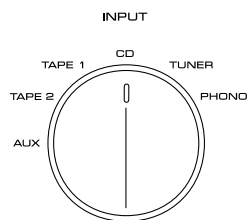

\* If you select turntable as an input source (PHONO position), you should confirm that the **PHONO (MM/MC)** switch is set to the position corresponding to the type of cartridge being used by the turntable. (Refer to page 9.)

4 Select the speakers to be used.

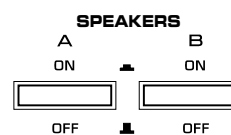

\* If you use two speaker systems, press both the A and B switches.

5 Play the source.

6

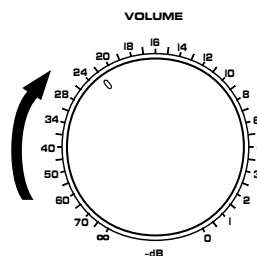

Adjust to the desired output level.

7 If desired, adjust the **BASS, TREBLE, BALANCE** and **LOUDNESS** controls, etc. (Refer to page 8–9.)

### To turn off the power

Press the **POWER** switch again.

### CD DIRECT AMPLIFIER

Setting the **INPUT SELECTOR** to the CD position automatically sends the signals from the CD player (connected to the CD input terminals on the rear of this unit) to the built-in **CD DIRECT AMPLIFIER** specially developed for CD sound directly. CD sound is reproduced purely and clearly by this signal routing.

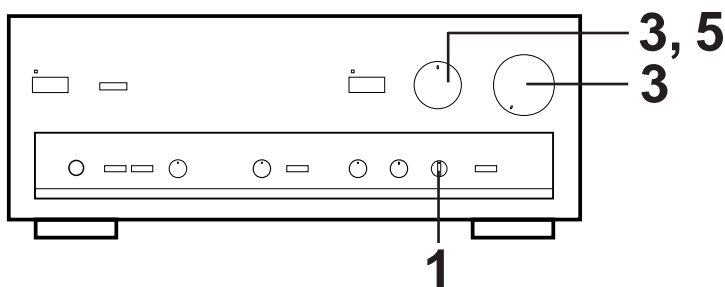

## TO RECORD A SOURCE TO TAPE (OR DUB FROM A TAPE TO ANOTHER)

**1** Select the source to be recorded.

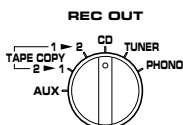

**2** Play the source.

**3** Confirm the source by selecting it with the **INPUT** selector and turning up the **VOLUME** control.

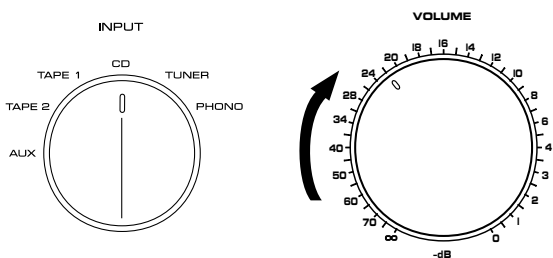

**4** Set the tape deck to be used for recording in the recording mode.

**5** To monitor the sound to be recorded (or being recorded), select the tape deck being used for recording with the **INPUT** selector.

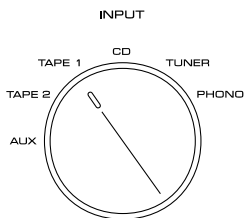

### Notes

- If you want to enjoy another source while recording, select it with the **INPUT** selector.
- The settings of **VOLUME**, **BASS**, **TREBLE**, **BALANCE**, **LOUDNESS** controls and **PURE DIRECT** switch have no effect on the material being recorded.

### REC OUT selector setting on tape dubbing

To dub from tape deck 1 to tape deck 2

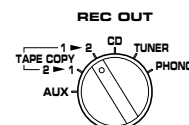

To dub from tape deck 2 to tape deck 1

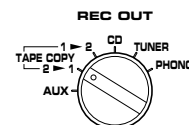

## Adjusting the BALANCE control

Adjust the balance of the output volume to the left and right speakers to compensate for sound imbalance caused from speaker location or listening room conditions.



## Selecting the SPEAKER system

Because one or two speaker systems can be connected to this unit, the **SPEAKERS** switches allow you to select speaker system **A** or **B**, or both at once.

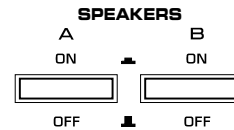

## Adjusting the BASS and TREBLE controls

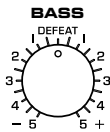

## Adjusting the continuously variable LOUDNESS control

This control provides compensation for the human ears' loss of sensitivity to high and low-frequency ranges at low volume. This control is adjustable to retain full tonal range at any volume level.

- 1 Set to the "FLAT" position.

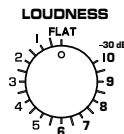

**BASS** : Turn this clockwise to increase (or counter-clockwise to decrease) the low frequency response.

**TREBLE** : Turn this clockwise to increase (or counter-clockwise to decrease) the high frequency response.

- 2 Set to the loudest listening level that you would listen to.

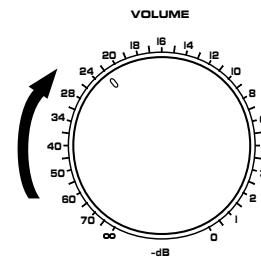

- 3 Turn until the desired volume is gained.

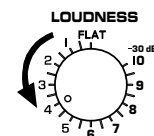



## Using the PURE DIRECT switch

You can enjoy the purest possible sound from your audio sources by setting this switch so that the indicator illuminates. By doing so, the audio signals bypass the **BASS, TREBLE, SUBSONIC FILTER, BALANCE, LOUDNESS** controls and the **PRE OUT/MAIN IN** terminals, thus eliminating any alterations to the audio signals.



## PHONO (MM/MC) switch

Select either MM or MC position depending on your PHONO cartridge, Moving Magnet or Moving Coil type. However, if you use a high output MC cartridge, select MM position. To select the MC position, press this switch so that it is held inward. To select the MM position, press this switch so that it is released outward.

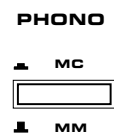

## Setting the SUBSONIC FILTER switch

If you set this switch to "ON" position, undesirable ultra-low-frequency signals caused by turntable rumble or warped records can be cut out without losing sound quality.

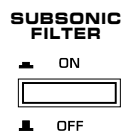

## When you listen with headphones

Connect the headphones to the **PHONES** jack. When listening with headphones privately, set both the **SPEAKERS A** and **B** switches to the OFF position.

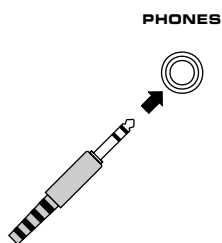

## Open/close the control door

When it is not necessary to operate controls inside the control door, close the door.

To close the door

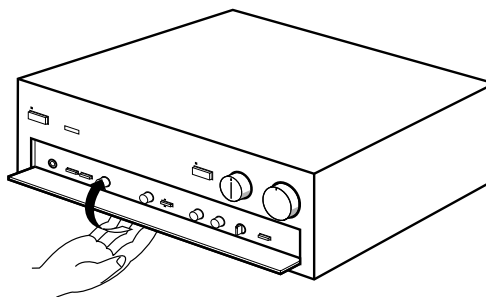

To open the door

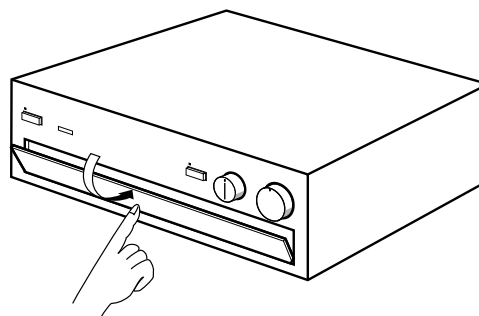

# REMOTE CONTROL TRANSMITTER

The remote control transmitter provided with this unit is designed to control all the most commonly used functions of the unit. If the CD player, tuner, turntable and tape deck connected to this unit are YAMAHA components designed for remote control compatibility, then this remote control transmitter will also control various functions of each component.

## KEY FUNCTIONS

### For Control of This Unit

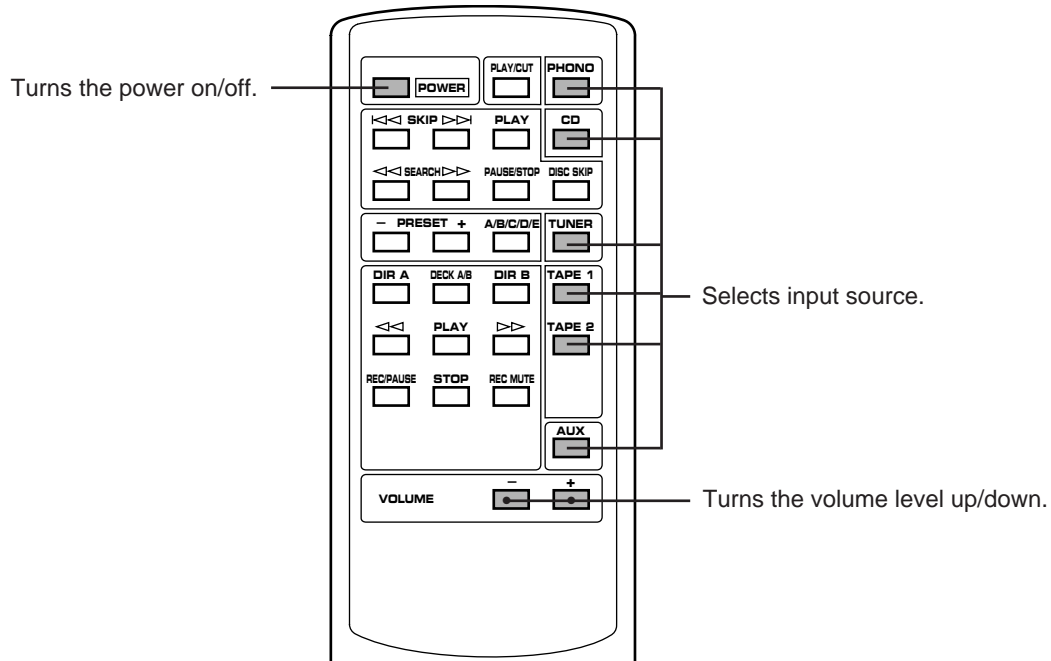

### For Other Component Control

Identify the remote control transmitter keys with your component's keys. If these keys are identical, their function will be the same. On each key function, refer to the corresponding instruction on your component's manual.

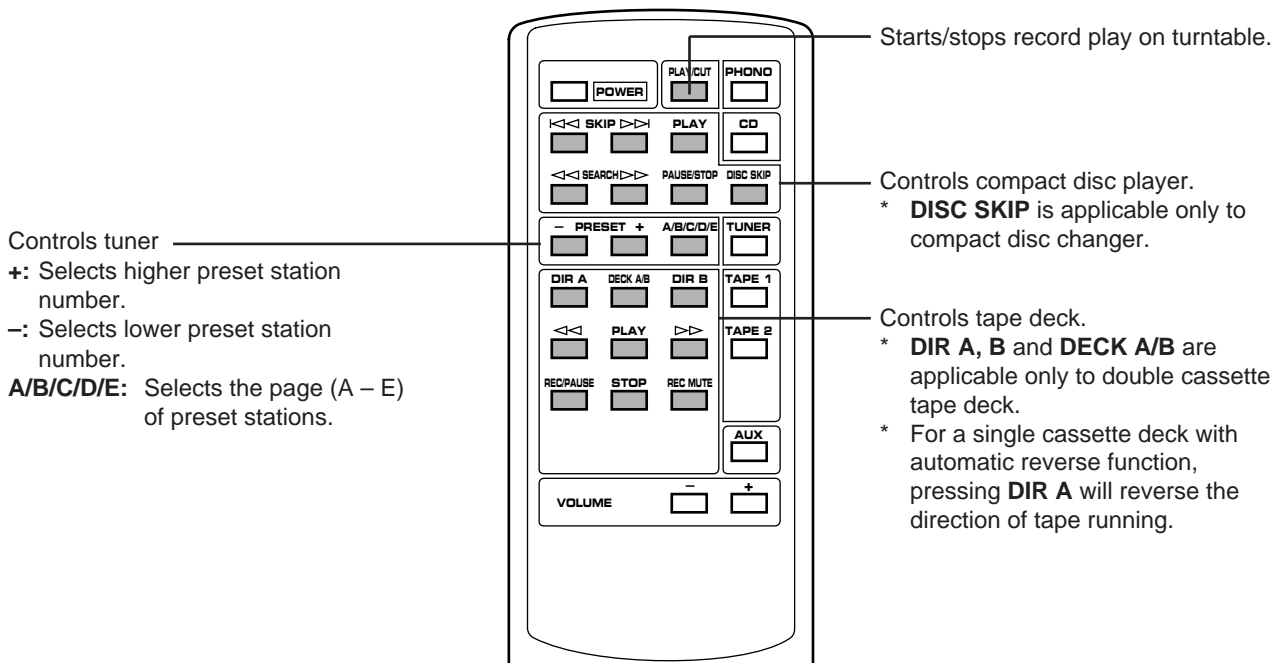

## STANDBY mode (Europe model only)

While the power is on, pressing the **POWER** key on the remote control transmitter switches the unit to the STANDBY mode. (In this mode, the indicator is half illuminated.)

### Note

The **POWER** switch on the front panel of this unit should be turned off when left unused for a long period of time.

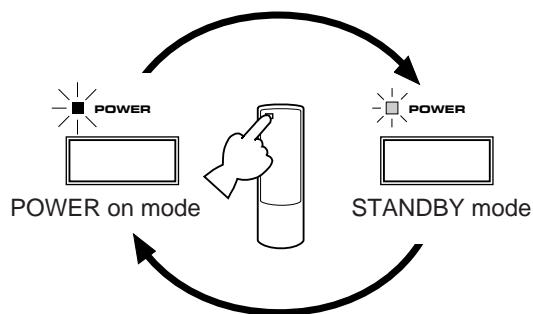

## NOTES ABOUT THE REMOTE CONTROL TRANSMITTER

### Battery installation

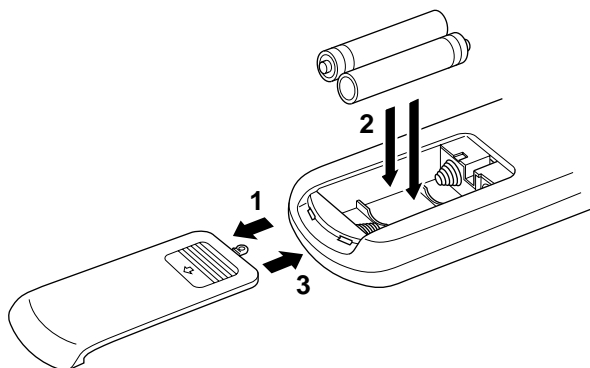

### Battery replacement

If you find that the remote control transmitter must be used closer to the main unit, the batteries are weak. Replace both batteries with new ones.

### Notes

- Use only AA, R6, UM-3 batteries for replacement.
- Be sure the polarities are correct. (See the illustration inside the battery compartment.)
- Remove the batteries if the remote control transmitter will not be used for an extended period of time.
- If batteries leak, dispose of them immediately. Avoid touching the leaked material or letting it come in contact with clothing, etc. Clean the battery compartment thoroughly before installing new batteries.

### Remote control transmitter operation range

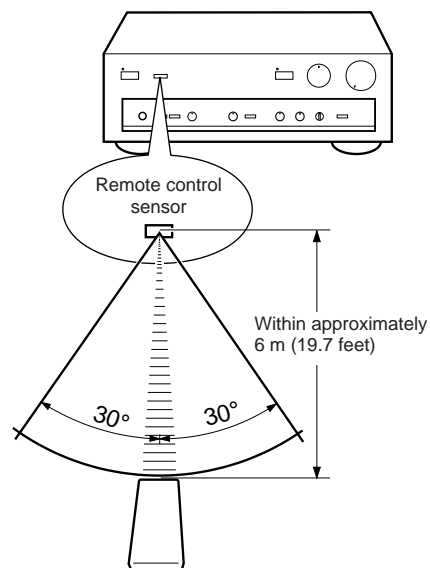

### Notes

- There should be no large obstacles between the remote control transmitter and the main unit.
- If the remote control sensor is directly illuminated by strong lighting (especially an inverter type of fluorescent lamp etc.), it might cause the remote control transmitter not to work correctly. In this case, reposition the main unit to avoid direct lighting.

# TROUBLESHOOTING

If the unit fails to operate normally, check the following points to determine whether the fault can be corrected by the simple measures suggested. If it cannot be corrected, or if the fault is not listed in the SYMPTOM column, disconnect the power cord and contact your authorized YAMAHA dealer or service center for help.

SYMPTOM	CAUSE	REMEDY
<b>The unit fails to turn on when the POWER switch is pressed.</b>	Power cord is not plugged in or is not completely inserted.	Firmly plug in the power cord.
<b>No sound.</b>	Incorrect output cord connections.	Connect the cords properly. If the problem persists, the cords may be defective.
	Appropriate input source is not selected.	Select an appropriate input source with the INPUT selector.
	The SPEAKERS switches are not set properly.	Set the SPEAKERS switch which corresponds to the speakers to be used to the ON position.
	Speaker connections are not secure.	Secure the connections.
<b>The sound suddenly goes off.</b>	The protection circuit has functioned because of short circuit etc.	Turning the unit off and then on will reset the protection circuit.
<b>Only one side speaker outputs the sound.</b>	Incorrect setting of the BALANCE control.	Adjust it to the appropriate position.
	Incorrect cord connections.	Connect the cords properly. If the problem persists, the cords may be defective.
<b>There is a lack of bass, and no ambience.</b>	The + and – wires are connected in reverse at the amplifier or speakers.	Connect the speaker wires in the correct phase (+ and –).
<b>Sound “hums”.</b>	Incorrect cord connections.	Firmly connect the audio plugs. If the problem persists, the cords may be defective.
	No connection from the turntable to the GND terminal.	Make the GND connection between the turntable and this unit.
<b>Sound level is low or sound is distorted while playing a record on the turntable.</b>	The LOUDNESS control is functioning.	Set the LOUDNESS control to the FLAT position.
	The PHONO (MM/MC) switch is set to the improper position.	Set the PHONO (MM/MC) switch to the proper position.
<b>Using the BASS, TREBLE, BALANCE, LOUDNESS controls and SUBSONIC FILTER switch does not affect the tone.</b>	The PURE DIRECT switch is ON.	The PURE DIRECT switch must be switched OFF to use those controls.
<b>The remote control transmitter does not work.</b>	Direct sunlight or lighting (of an inverter type of fluorescent lamp etc.) is striking the remote control sensor of the main unit.	Change position of the main unit.
<b>The distance or range within which the remote control transmitter can be used decreases.</b>	The batteries of this remote control transmitter are too weak.	Replace the batteries with new ones.

# SPECIFICATIONS

Minimum RMS Output Power per Channel 8 ohms, 20 Hz to 20 kHz, 0.015% THD .....110W+110W 6 ohms, 20 Hz to 20 kHz, 0.03% THD .....130W+130W	Output Level/Impedance REC OUT .....150 mV/2.2 k-ohms PRE OUT .....1.0V/1.6 k-ohms	Tone Control Characteristics BASS: Boost/cut .....±10 dB (20 Hz) Turnover Frequency .....(350 Hz) TREBLE: Boost/cut .....±10 dB (20 kHz) Turnover Frequency .....(3.5 kHz)
Dynamic Power per Channel (by IHF Dynamic Headroom measuring method) 8/6/4/2 ohms .....150/200/250/330W	Maximum Voltage Output 20 Hz to 20 kHz, 0.01% THD (PRE OUT) .....1.4V	Filter Characteristics SUBSONIC FILTER .....15 Hz, -18 dB/oct
DIN Standard Output Power per Channel [Europe model only] (4 ohms, 1 kHz, 0.7% THD) .....185W	Headphone Jack Rated Output/ Impedance Output Level (8 ohms, 0.015% THD) .....0.5V Impedance .....470 ohms	Continuous Loudness Control Attenuation .....-30 dB (1 kHz) (Level related equalization)
Dynamic Headroom [General model only] 8/6 ohms .....1.35 dB/0.97 dB	Frequency Response (20 Hz to 20 kHz) CD/TUNER/TAPE/AUX .....0±0.5 dB MAIN IN .....0±0.5 dB	Gain Tracking Error (0 to -60 dB) .....2 dB
IEC Power [Europe model only] (8 ohms, 1 kHz, 0.01% THD) .....125W	RIAA Equalization Deviation PHONO MM .....0±0.3 dB PHONO MC .....0±0.5 dB	Power Supply [Australia model] .....AC 240V, 50 Hz [Europe model] .....AC 220V, 50 Hz [General model] .....AC 110/120/220/240V, 50/60 Hz
Power Band Width 8 ohms, 55W, 0.03% THD .....10 Hz to 50 kHz	Total Harmonic Distortion (20 Hz to 20 kHz) PHONO MM to REC OUT (3V) .....0.003% PHONO MC to REC OUT (3V) .....0.007% CD/TUNER/TAPE/AUX to PRE OUT (1V) .....0.005% CD/TUNER/TAPE/AUX to SP OUT (55W/8 ohms) .....0.008% MAIN IN to SP OUT (55W/8 ohms) .....0.006%	Power Consumption .....270W
Damping Factor 8 ohms, 20 Hz-20 kHz .....320 or more	Signal-to-Noise Ratio (IHF-A Network) PHONO MM (5 mV Input Shorted) .....92 dB PHONO MC (500 µV Input Shorted) .....75 dB CD .....110 dB	AC Outlets [Europe and General models] 3 SWITCHED OUTLETS .....200W max. total [Australia model] 1 SWITCHED OUTLET ....200W max. total
Damping Factor (DIN) [Australia and Europe models] 4 ohms, 40 Hz .....160 or more 4 ohms, 12.5 kHz .....160 or more	Residual Noise (IHF-A Network) CD .....70 µV	Dimensions (W x H x D) .....435 x 171 x 448 mm (17-1/8" x 6-3/4" x 17-5/8")
Maximum Output Power (EIAJ) [General model only] 8 ohms, 1 kHz, 10% THD .....160W 6 ohms, 1 kHz, 10% THD .....190W	Channel Separation (Vol. -30 dB) CD/TUNER/TAPE/AUX (Input 5.1 k-ohms Terminated 1 kHz/10 kHz) .....65 dB/50 dB	Weight .....14.2 kg (31 lbs. 4 oz.)
Input Sensitivity/Impedance PHONO MM .....2.5 mV/47 k-ohms PHONO MC .....160 µV/220 ohms CD/TUNER/TAPE/AUX ....150 mV/47 k-ohms MAIN IN .....0.9V/47 k-ohms		Accessories .....Remote control transmitter Batteries
Maximum Input Signal (1 kHz, 0.01% THD) PHONO MM .....160 mV PHONO MC .....12.5 mV		Specifications subject to change without notice.

# SPECIFICATIES

Minimum RMS uitgangsvermogen per Kanaal  
8 ohm, 20 Hz tot 20 kHz, 0,015% Totale  
Harmonische Vervorming.....110W+110W  
6 ohm, 20 Hz tot 20 kHz, 0,03% Totale  
Harmonische Vervorming.....130W+130W

Dynamische Vermogen per Kanaal (IHF  
Meetmethode voor Vrij Dynamisch Bereik)  
8/6/4/2 ohm.....150/200/250/330W

DIN Standaard Uitgangsvermogen per Kanaal  
[Alleen modellen voor Europa]  
(4 ohm, 1 kHz, 0,7% Totale Harmonische  
Vervorming) .....185W

Vrij Dynamisch Bereik  
[Alleen Algemene modell]  
8/6 ohm .....1,35 dB/0,97 dB

IEC Vermogen  
[Alleen modellen voor Europa]  
(8 ohm, 1 kHz, 0,01% Totale Harmonische  
Vervorming).....125W

Vermogensbandbreedte  
8 ohm, 55W, 0,03% Totale Harmonische  
Vervorming .....10 Hz tot 50 kHz

Dempingsfactor (8 ohm, 20 Hz tot 20 kHz)  
.....320 of meer

Dempingsfactor (DIN)  
[Modellen voor Australië en Europa]  
4 ohm, 40 Hz.....160 of meer  
4 ohm, 12,5 kHz.....160 of meer

Maximum Uitgangsvermogen (EIAJ)  
[Alleen Algemene modell]  
8 ohm, 1 kHz, 10% Totale Harmonische  
Vervorming).....160W  
6 ohm, 1 kHz, 10% Totale Harmonische  
Vervorming).....190W

Ingangsgevoeligheid/Impedantie  
PHONO MM.....2,5 mV/47 k-ohm  
PHONO MC .....160 µV/220 ohm  
CD/TUNER/TAPE/AUX  
.....150 mV/47 k-ohm  
MAIN IN .....0,9V/47 k-ohm

Maximum Ingangssignaalniveau (1 kHz,  
0,01% Totale Harmonische Vervorming)  
PHONO MM.....160 mV  
PHONO MC .....12,5 mV

Uitgangsniveau/Impedantie  
REC OUT.....150 mV/2,2 k-ohms  
PRE OUT.....1,0V/1,6 k-ohm

Maximum uitgangsspanning  
20 Hz tot 20 kHz, 0,01% Totale  
Harmonische Vervorming (PRE OUT)  
.....1,4V

Nominaal Uitgangsvermogen/Impedantie van  
Hoofdfoneingang  
Uitgangsniveau (8 ohm, 0,015% Totale  
Harmonische Vervorming) .....0,5V  
Impedantie .....470 ohm

Frekventiebereik (20 Hz tot 20 kHz)  
CD/TUNER/TAPE/AUX .....0±0,5 dB  
MAIN IN .....0±0,5 dB

RIAA Balans Afwijking  
PHONO MM.....0±0,3 dB  
PHONO MC .....0±0,5 dB

Totale Harmonische Vervorming  
(20 Hz tot 20 kHz)  
PHONO MM naar REC OUT (3V)  
.....0,003%  
PHONO MC naar REC OUT (3V)  
.....0,007%  
CD/TUNER/TAPE/AUX naar PRE OUT (1V)  
.....0,005%  
CD/TUNER/TAPE/AUX naar SP OUT  
(55W/8 ohm) .....0,008%  
MAIN IN naar SP OUT  
(55W/8 ohm) .....0,006%

Signaal/Ruis Verhouding (IHF-A Network)  
PHONO MM (5 mV Ingangssignaal .....  
Kortgesloten) .....92 dB  
PHONO MC (500 µV Ingangssignaal .....  
Kortgesloten) .....75 dB  
CD.....110 dB

Reststoring (IHF-A Network)  
CD.....70 µV

Kanaalscheiding (Vol. -30 dB)  
CD/TUNER/TAPE/AUX (Ingangsvermogen  
5,1 k-ohm Begrensd 1 kHz/10 kHz)  
.....65 dB/50 dB

Karakteristieken van Klankregeling  
BASS: Versterking/afsluiting  
.....±10 dB (20 Hz)  
Omzetsfrequentie.....350 Hz  
TREBLE: Versterking/afsluiting  
.....±10 dB (20 kHz)  
Omzetsfrequentie.....3,5 kHz  
Filterkarakteristieken  
SUBSONIC FILTER .....15 Hz, -18 dB/oct

Continue Loudness Regeling  
Afwakking .....-30 dB (1 kHz)  
(Niveau-gekoppelde balansregeling)

Spoorafwijking van Versterking (0 - -60 dB)  
.....2 dB

Spanningsvereisten  
[Modellen voor Australië]  
.....240V, 50 Hz wisselstroom  
[Modellen voor Europa]  
.....220V, 50 Hz wisselstroom  
[Algemene modellen]  
.....110/120/220/240V,  
50/60 Hz wisselstroom

Stroomverbruik .....270W

Netspanningsuitgangen (AC OUTLETS)  
[Modellen voor Europa en Algemene  
modellen]  
3 GESCHAKELDE  
.....Max. totaal vermogen 200W

[Modellen voor Australië]  
1 GESCHAKELDE  
.....Max. totaal vermogen 200W

Afmetingen (L x H x B)  
.....435 x 171 x 448 mm

Gewicht.....14,2 kg

Toebehoren.....Afstandbediening  
Batterijen

Alle specificaties zijn onder voorbehoud en  
kunnen zondere nadere kennisgeving worden  
gewijzigd.