

YAMAHA

STEREO POWER AMPLIFIER

M-2

OWNER'S MANUAL

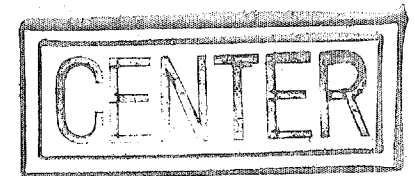
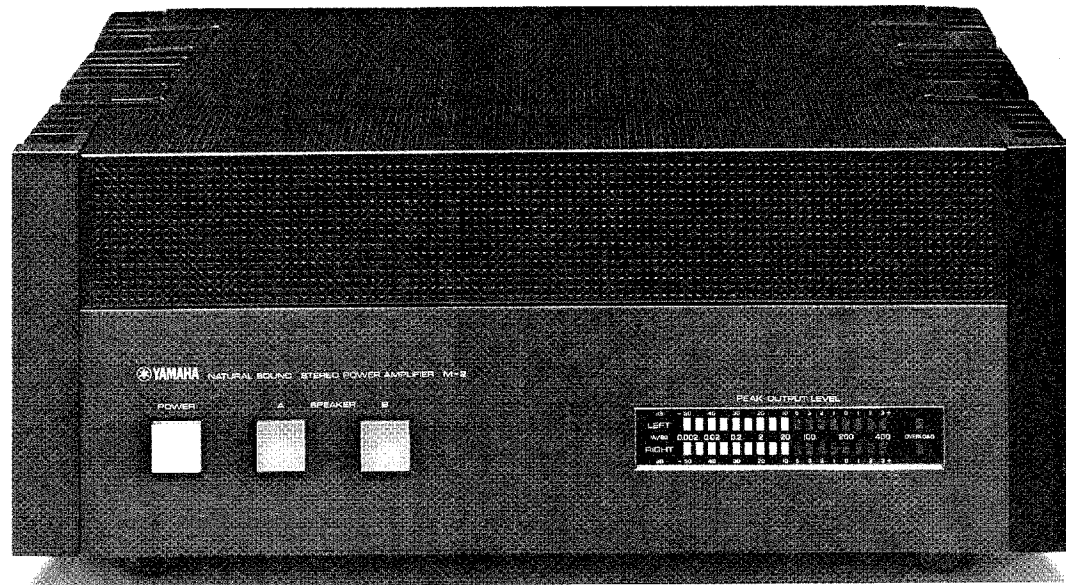

Thank you very much for purchasing the YAMAHA Stereo Power Amplifier M-2 Developed by applying the best of YAMAHA's superior electronic technology, the M-2 is a DC stereo power amplifier that achieves an extremely high level of performance.

The output stage, which uses pure complementary OCL and triple push-pull circuitry, produces the rated output of 240W + 240W without any strain on the large-capacity power supply section.

Before first operating your M-2, please read this Owner's Manual carefully, in order to fully realize the potential of the unit and to keep it in best condition for many years of trouble-free use.

CONTENTS

Features	2
Caution; Read This Before Operating	
Your M-2	3
Connection Diagram	4
Front Panel and Controls	6
Connection and Operation	7
Specifications	8
Block Diagram	9
Schematic Diagram	10
Troubleshooting	11

- The voltage amplifying stage employs a cascade-connected differential two-stage circuit throughout.
The use of a Dual FET input and a cascode bootstrap circuit in the first stage and a cascode-connection, current mirror and push-pull output in the pre-drive stage ensures a high degree of stability, low distortion and improved high-frequency characteristics.
- Two extremely large 22,000 μ F capacitors, two separate constant-voltage power supplies for the voltage amplifying stage, and the use of a pure copper plate earth line for ultra-low impedance guarantee greatly reduced intermodulation distortion, improved separation and absolutely stable operation.
- Other Features
Except for the chemical capacitors in the power supply section, mylar and styrol capacitors are employed throughout.
Layout of parts, wiring, earth line as well as many other aspects have been given due consideration.
The basic design ensures high reliability, while the ultimate aim has been the improvement of the overall audio characteristics.
- In the driver and the power amplifier a three-stage emitter follower is pure complementary OCL SEPP circuitry using high-ft transistors. This accounts for wide bandwidth, high output and low distortion.

IMPORTANT!

Please record the serial number of your unit in the space below

Model Name	M-2
Serial No.	_____

The serial number is located on the rear of the chassis.

Retain this Owner's Manual in a safe place for future reference.

M-2

CAUTION:READ THIS BEFORE OPERATING YOUR M-2

1 PLACE OF INSTALLATION

Do not use the set in

- locations exposed to direct sunshine, such as near windows
- locations of high temperatures, such as near heaters
- locations of extremely low temperatures
- humid or dusty locations
- Since the M-2 is quite heavy [20.9 kg] it should be placed on a firm base.

2 WATER DAMAGE

If by accident the set has come into contact with water, immediately disconnect the power plug and contact your YAMAHA service store. Be careful not to place any container that holds liquid near the amplifier.

3 PROPER VENTILATION

Never cover the ventilation holes on top of the amplifier with any object. If proper ventilation is not ensured, the internal temperature of the set will rise unduly, which will cause improper operation and lead to damage.

4 CAREFUL HANDLING

Avoid using strong force when operating any of the switches and controls.

5 UNAUTHORIZED OPENING

Never open the case of the amplifier or touch any of the parts inside, as there is serious danger of electric shock.

If, by accident, some foreign matter has been dropped inside the set, immediately disconnect the power plug and contact your YAMAHA service store.

6 ADDITIONAL AC POWER OUTLET

The additional AC power outlet on the rear panel of the set is UNSWITCHED (not linked with the power switch) and has a maximum capacity of 100W. Before connecting another piece of equipment to this outlet, check its power consumption to ensure it does not exceed this limit.

7 MOVING THE SET

Before moving the amplifier, be sure to disconnect the power plug as well as all other connection cords.

8 POWER CORD

When disconnecting the power cord, always hold the plug itself and do not pull the cord. When the set is not to be used for a long period of time, it is recommended to disconnect the power cord.

9 PLAYING RECORDS

Be sure to turn down the volume on the control amplifier before lifting or lowering the tone arm when playing records. Otherwise the transient noise may cause damage to the speakers.

10 MAKING CONNECTIONS

Always switch off the power before connecting or disconnecting the input cables.

11 CLEANING

Avoid wiping the case with liquids such as benzine or thinner, and do not use insecticide sprays or the like near the set. Always use a soft, dry cloth to wipe the set.

12 BEFORE REQUESTING SERVICE

Before calling in a service technician, please check the TROUBLESHOOTING chart in the last section of this manual to be sure there is no misoperation.

13 OWNER'S MANUAL

Please keep this Owner's Manual for future reference.

M-2

CONNECTION DIAGRAM

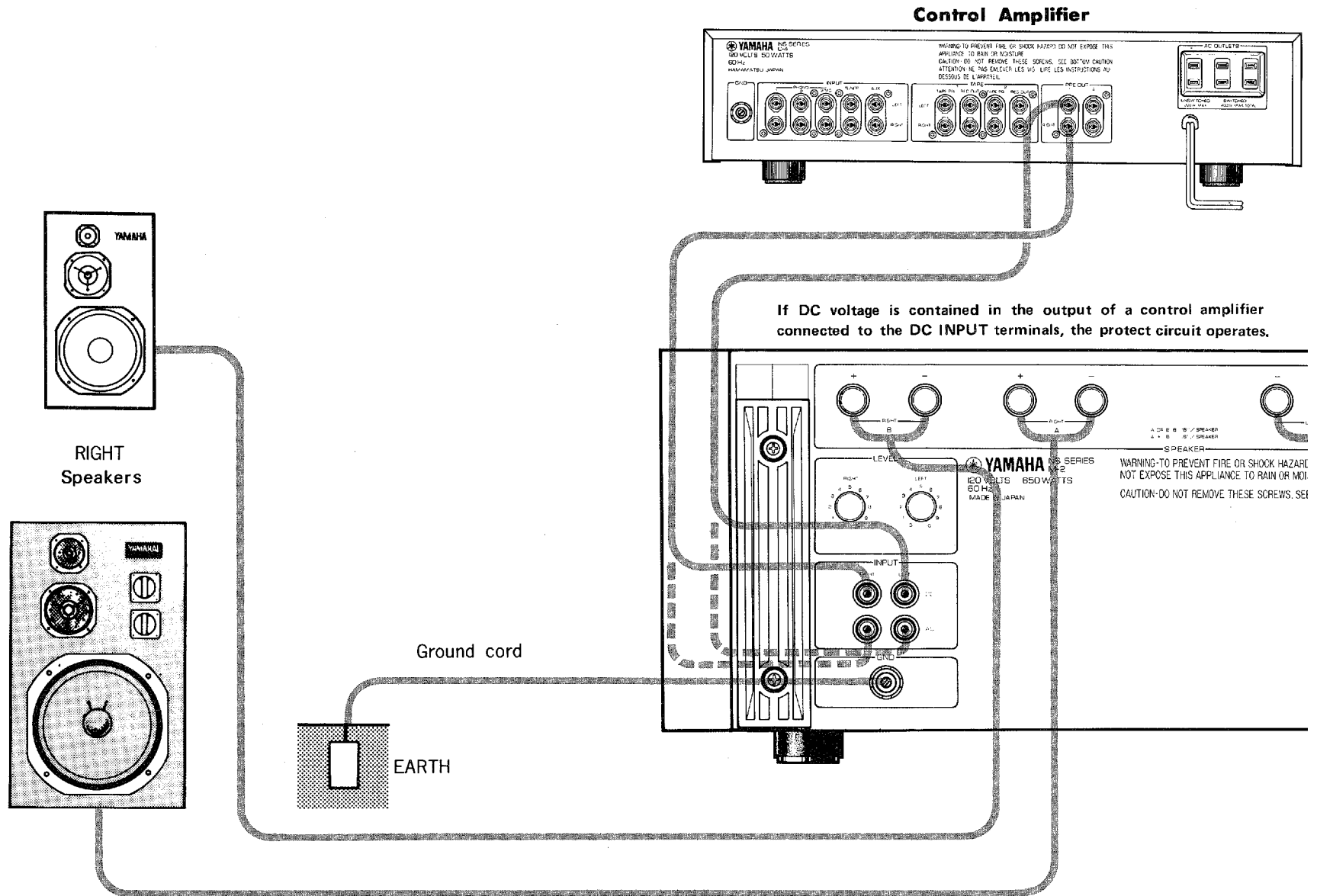

• Canadian Model

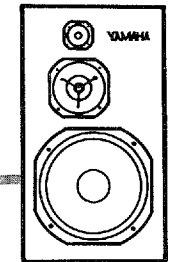
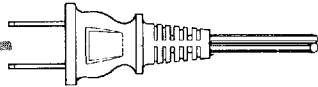
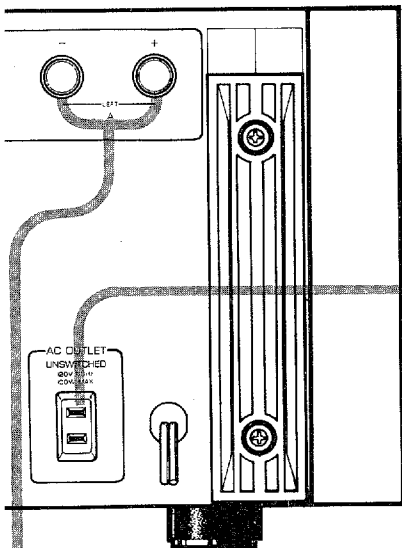
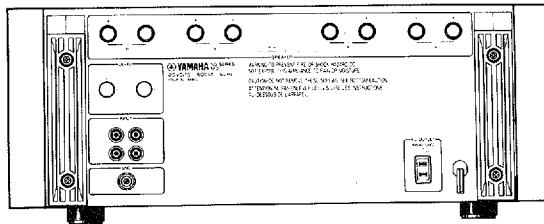

LEFT
Speakers

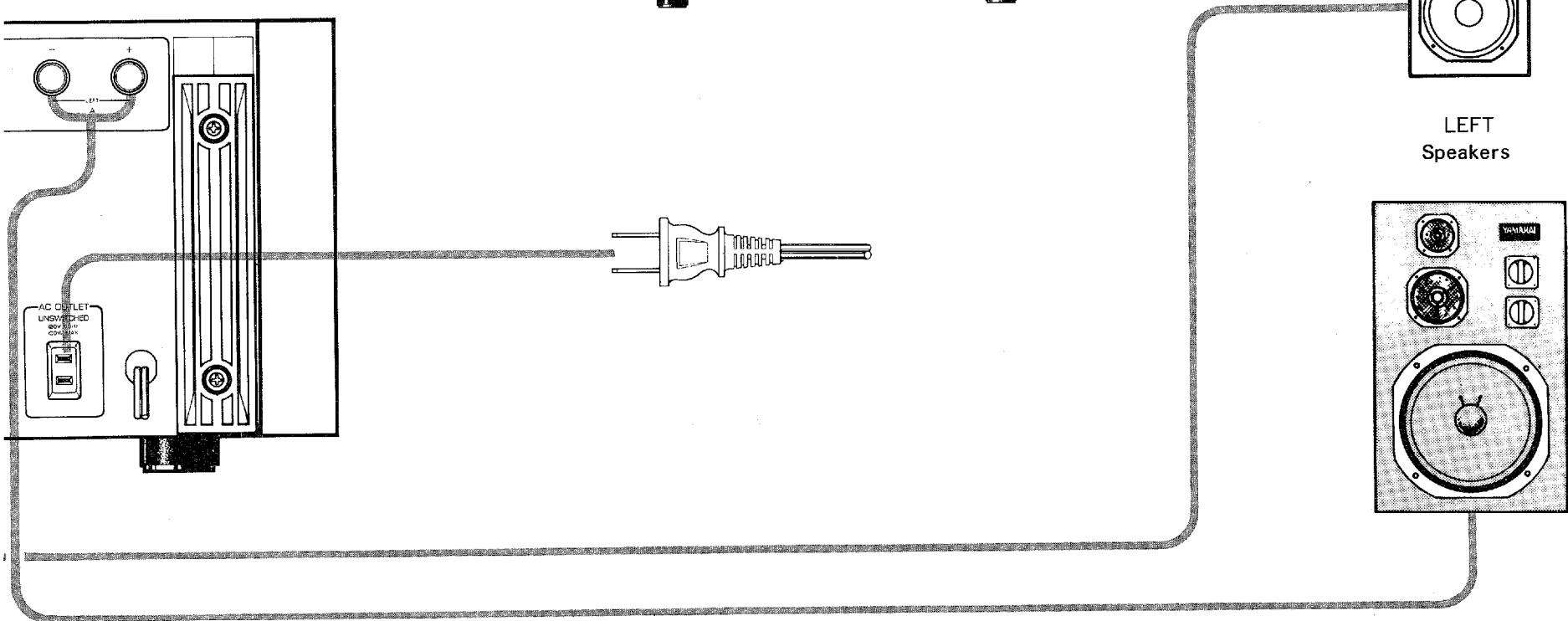
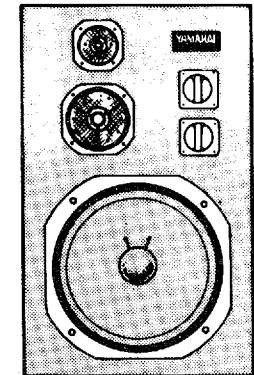

M-2

FRONT PANEL AND CONTROLS

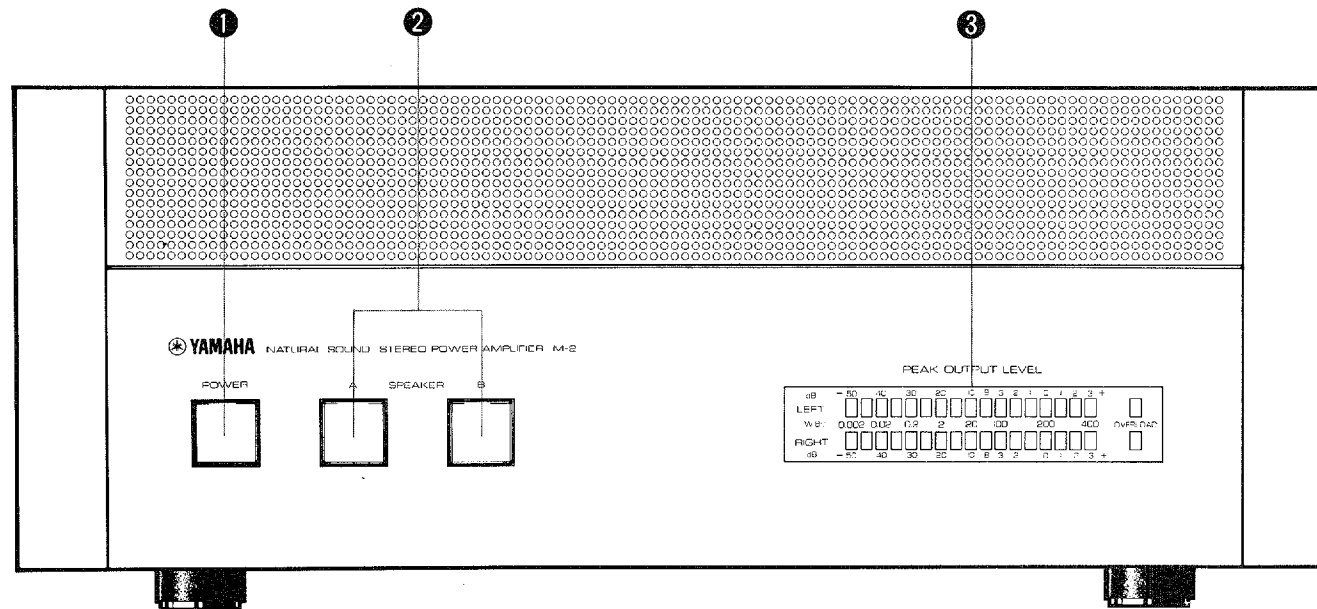

① POWER(switch)

When this button is depressed, power to the unit will be switched on and the switch will light up. When depressed again, power is turned off.

■ Due to the action of the muting relay, no sound will be heard for several seconds after switching on the power. This prevents any transient switching noises from reaching the speakers.

■ Be sure to turn down the VOLUME control on the control amplifier to minimum before turning on the POWER switch to guard the speakers against any sudden loud program sounds produced after the muting relay time.

② SPEAKERS(A and B)

These two push-button switches govern the two speaker terminals A and B. When depressed, the speaker set connected to the respective terminal will be connected and the switch will light up. Depressing the switch again will disconnect the speakers.

When using both terminals at the same time, refer to "Speaker Connections" (p. 7) regarding speaker impedance.

The SPEAKER switches should be turned off when changing the connection of the speaker cords, and they can be used in other cases, such as changing program sources etc., as well.

③ PEAK OUTPUT LEVEL (PEAK and OVERLOAD INDICATOR)

These peak indicators provide visual indication of the left and right output levels. They cover a range of 0.002W to 400W (8Ω) (-50dB to 3dB).

Note: Also that the meters are calibrated accurately for output power into standard 8Ω speakers, but that corrections must be applied if speakers with different impedance are used.

Clipping (at about 2% THD) is indicated for the left and right outputs separately by the OVERLOAD indicators. When these light up, turn down the input level by using the LEVEL controls on the rear panel.

M-2

CONNECTION AND OPERATIONS

AC CONNECTION

1. As the M-2 has very high power consumption, do not connect it to an additional AC outlet on some other piece of equipment, but plug it directly into a wall outlet.
2. Regardless of the position of the power switch, the additional AC power outlet on the rear panel of the M-2 provides AC power for a maximum consumption of 100W.

SPEAKERS CONNECTION

Speakers with any impedance from $8 \sim 16\Omega$ can be connected to either of the A or B terminals on the rear panel. When using two sets of speakers at the A and B terminals simultaneously, be sure to use only speakers having an impedance of 16Ω .

1. To connect the speaker cords to the speaker terminals, loosen the terminal knob by turning it to the left (anti-clockwise) so that you can see the hole into which the cord will inserted.

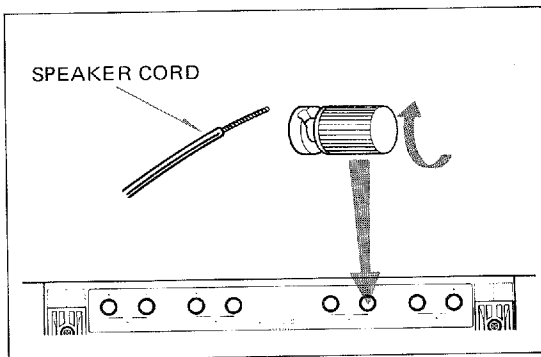

2. Insert the stripped speaker cord into the hole, turn the terminal knob to the right (clockwise) and tighten it fast.
Two sets of speaker systems can be connectable to M-2. The terminals on the left are for right speakers and those on the right for left speakers.

CONNECTION TO CONTROL AMPLIFIER

Switch off the power to the control amplifier as well as to the power amplifier.

DC Terminal Connections

To use M-2 as a DC amplifier, connect the output cable from the control amplifier to DC INPUT terminals on the rear panel.

To use M-2 as a DC amplifier, also use Low-Cut Filter and Sub-Sonic Filter so as to prevent ultra-low frequency noise (due to disc warping or irregular turntable rotation, etc.) from entering the speakers.

AC INPUT Terminal Connections

In general, the output cable from the Control Amplifier is connected to this terminal.

This will provide added protection to speaker from the harmful effects that subsonic rumbles, etc., can connect to the DC INPUT terminals.

Note: It is not connectable to both of DC INPUT and AC INPUT terminals at the same time. So, connect it to either terminal at a time depending on the type and use of your audio equipment.

LEVEL CONTROLS

- Level controls are provided on the rear panel to adjust the M-2 for use with any control amplifier.
The right hand knob is for the left channel and the left hand one for the right channel.
If the sound is distorted by using a control amplifier with a high output, lower the input sensitivity by turning these knobs counterclockwise.

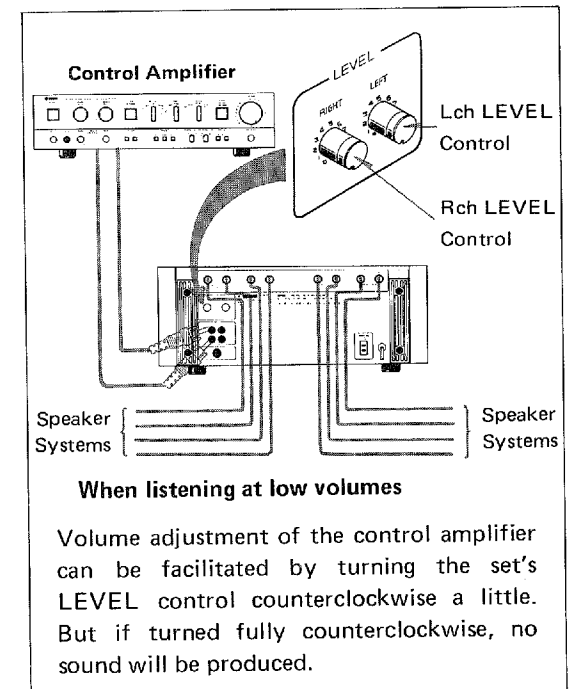

M-2

SPECIFICATIONS

Rated Output Power	
240W + 240W (8Ω, 20Hz~30kHz 0.005% T.H.D)	
Power Band Width	
10Hz~100kHz (8Ω, 120W, 0.01% T.H.D)	
Input Sensitivity/Impedance	
1.62V (240W/8Ω)/25kΩ ±5kΩ	
Frequency Response	
DC Input	8Ω, 1W
1kHz	: 0dB
100kHz	: -0.7±0.5dB
AC Input	8Ω, 1W
10Hz	: -1.5±1dB
1kHz	: 0dB
Residual Noise	
20μV (8Ω, IHF-A Network, Input VR min.)	

Harmonic Distortion	
Less than 0.004% (8Ω, 10Hz~20kHz, 120W)	
Less than 0.007% (8Ω, 50kHz, 120W)	
Less than 0.01% (100kHz, 120W)	
IM Distortion (IHF)	
Less than 0.002% (8Ω, 50Hz:7kHz=4:1, 60W)	
Channel Separation (L → R, R → L)	
97dB (8Ω, 1kHz, 120W)	
75dB (8Ω, 20kHz, 120W) (VR max, Input Shorted)	
Peak Indicator	
Indicator Point	: 0dB = 200W (8Ω, 1kHz)
Indicator Level	: +3dB~-50dB (-5dB step)
Attack Time	: 100μ sec.
Release Time	: 1.2 sec. (-50dB ↔ +3dB)

Overload Indicator	
Indicator Level	: 2% Distortion (8Ω, 1kHz)
Power Supply	
120V AC, 60Hz	
Rated Power Consumption	
U.S.A. Model	: 650W
Canadian Model	: 1500 VA
AC Outlet	
100W Unswitched x 1	
Dimensions	
W: 435, H: 183, D: 362mm (17-1/8") x (7-3/16") x (14-5/32")	
Weight	
20.9kg (46 lbs)	

Specifications subject to change without notice.

M-2

BLOCK DIAGRAM

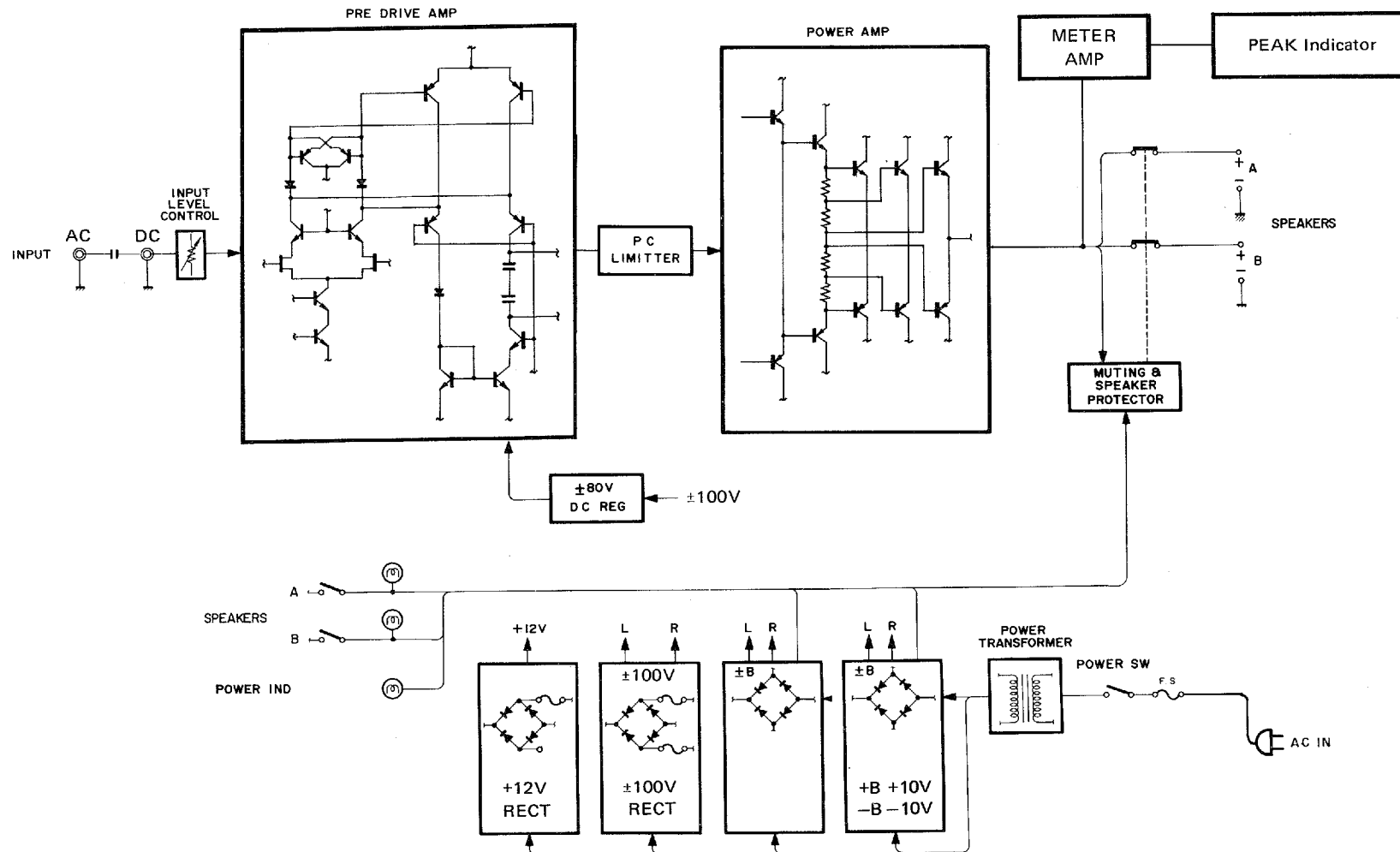

M-2

SCHEMATIC DIAGRAM

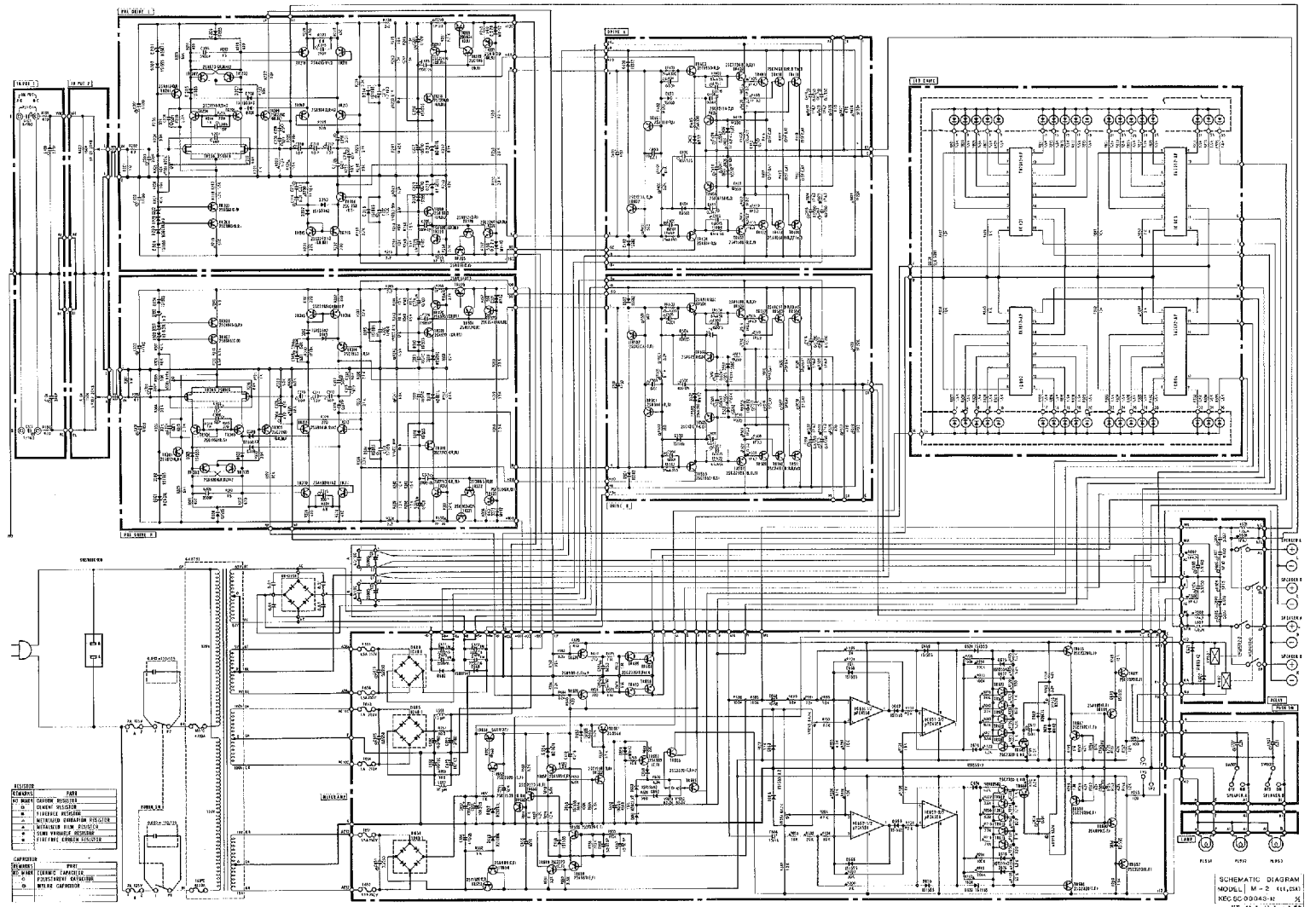

SCHEMATIC DIAGRAM
MODEL M-2 111,154
REG. U.S. PAT. OFF. 1948

M-2

TROUBLESHOOTING

Symptom	Cause	Remedy
Power will not turn on although POWER switch is ON.	Power cord plug is not firmly inserted into AC outlet.	Re-insert power plug into AC outlet in a firm manner.
	Power does not turn on when power plug is inserted into AC outlet.	Contact an audio serviceman at your nearest YAMAHA dealer.
No sound produced from the right and left speakers, or either the right, or left speaker.	Insufficient connection between control amplifier and power amplifier, or between power amplifier and speakers.	Check and confirm connection, or operation.
	BALANCE control of the control amplifier has deviated either to the right, or left side.	Properly re-adjust BALANCE control of control amplifier.
	LEVEL control turned down too much (Turned too far counterclockwise).	Turn LEVEL control clockwise.
Sounds suddenly cease during PLAY.	Speaker's protective circuit is working because a DC potential more than $\pm 1V$ has generated at the speaker's output terminal.	When the potential of the power amplifier becomes zero, the relay will be actuated, causing the circuit to be connected.
		Turn off the POWER switch of the power amplifier. Wait a little while and turn it on again.
	Abnormality inside the circuit.	Contact an audio serviceman at your nearest YAMAHA dealer.
Unnatural reproduced sounds with poor bass and unstable stereo image.	The phases (+ and -) of the power amplifier not matching those of the speakers.	After matching the phases properly, re-connect.
Sufficient volume not obtained when VOLUME control of control amplifier is turned up.	Input LEVEL control is turned counterclockwise.	Adjust to proper volume by turning input LEVEL control clockwise.
Loud humming generated during program audition.	Insufficient contact of pin plug.	Re-insert pin plug in firm manner.
	Earth line of turntable not connected to GND terminal of control amplifier.	Connect earth line to GND terminal of control amplifier.

SINCE 1887



YAMAHA

NIPPON GAKKI CO., LTD. HAMAMATSU, JAPAN