



YAMAHA

KX-E100

Natural Sound Stereo Cassette Deck

Platine Cassette Stéreo

REC LEVEL



MIN MAX

DIRECTION



micro component system

PIANOCRAFT

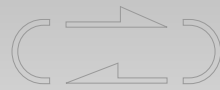

DD B C



**OWNER'S MANUAL
MODE D'EMPLOI**

SAFETY INSTRUCTIONS

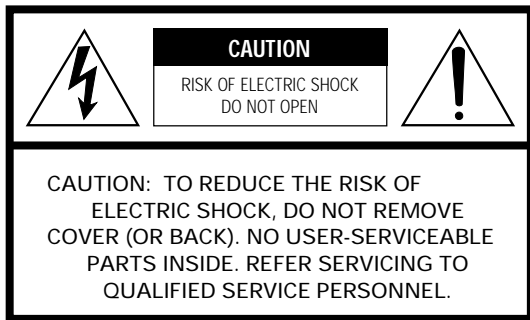

• Explanation of Graphical Symbols

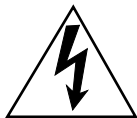

The lightning flash with arrowhead symbol, within an equilateral triangle, is intended to alert you to the presence of uninsulated “dangerous voltage” within the product’s enclosure that may be of sufficient magnitude to constitute a risk of electric shock to persons.



The exclamation point within an equilateral triangle is intended to alert you to the presence of important operating and maintenance (servicing) instructions in the literature accompanying the appliance.

WARNING
TO REDUCE THE RISK OF FIRE OR ELECTRIC SHOCK, DO NOT EXPOSE THIS UNIT TO RAIN OR MOISTURE.

IMPORTANT!
Please record the serial number of this unit in the space below.

Model:
Serial No.:

The serial number is located on the rear of the unit. Retain this Owner’s Manual in a safe place for future reference.

- 1 Read Instructions – All the safety and operating instructions should be read before the unit is operated.
- 2 Retain Instructions – The safety and operating instructions should be retained for future reference.
- 3 Heed Warnings – All warnings on the unit and in the operating instructions should be adhered to.
- 4 Follow Instructions – All operating and other instructions should be followed.
- 5 Water and Moisture – The unit should not be used near water – for example, near a bathtub, washbowl, kitchen sink, laundry tub, in a wet basement, or near a swimming pool, etc.
- 6 Carts and Stands – The unit should be used only with a cart or stand that is recommended by the manufacturer.



- 6A A unit and cart combination should be moved with care. Quick stops, excessive force, and uneven surfaces may cause the unit and cart combination to overturn.
- 7 Wall or Ceiling Mounting – The unit should be mounted to a wall or ceiling only as recommended by the manufacturer.
- 8 Ventilation – The unit should be situated so that its location or position does not interfere with its proper ventilation. For example, the unit should not be situated on a bed, sofa, rug, or similar surface, that may block the ventilation openings; or placed in a built-in installation, such as a bookcase or cabinet that may impede the flow of air through the ventilation openings.
- 9 Heat – The unit should be situated away from heat sources such as radiators, stoves, or other appliances that produce heat.
- 10 Power Sources – The unit should be connected to a power supply only of the type described in the operating instructions or as marked on the unit.
- 11 Power-Cord Protection – Power-supply cords should be routed so that they are not likely to be walked on or pinched by items placed upon or against them, paying particular attention to cords at plugs, convenience receptacles, and the point where they exit from the unit.
- 12 Cleaning – The unit should be cleaned only as recommended by the manufacturer.
- 13 Nonuse Periods – The power cord of the unit should be unplugged from the outlet when left unused for a long period of time.
- 14 Object and Liquid Entry – Care should be taken so that objects do not fall into and liquids are not spilled into the inside of the unit.
- 15 Damage Requiring Service – The unit should be serviced by qualified service personnel when:
 - A. The power-supply cord or the plug has been damaged; or
 - B. Objects have fallen, or liquid has been spilled into the unit; or
 - C. The unit has been exposed to rain; or
 - D. The unit does not appear to operate normally or exhibits a marked change in performance; or
 - E. The unit has been dropped, or the cabinet damaged.
- 16 Servicing – The user should not attempt to service the unit beyond those means described in the operating instructions. All other servicing should be referred to qualified service personnel.
- 17 Power Lines – An outdoor antenna should be located away from power lines.
- 18 Grounding or Polarization – Precautions should be taken so that the grounding or polarization is not defeated.

FCC INFORMATION (for US customers only)

1. IMPORTANT NOTICE: DO NOT MODIFY THIS UNIT!

This product, when installed as indicated in the instructions contained in this manual, meets FCC requirements. Modifications not expressly approved by Yamaha may void your authority, granted by the FCC, to use the product.

2. IMPORTANT:

When connecting this product to accessories and/or another product use only high quality shielded cables. Cable/s supplied with this product MUST be used. Follow all installation instructions. Failure to follow instructions could void your FCC authorization to use this product in the USA.

3. NOTE:

This product has been tested and found to comply with the requirements listed in FCC Regulations, Part 15 for Class "B" digital devices. Compliance with these requirements provides a reasonable level of assurance that your use of this product in a residential environment will not result in harmful interference with other electronic devices.

This equipment generates/uses radio frequencies and, if not installed and used according to the instructions found in the users manual, may cause interference harmful to the operation of other electronic devices.

Compliance with FCC regulations does not guarantee that interference will not occur in all installations. If this product is found to be the source of interference, which can be determined by turning the unit "OFF" and "ON", please try to eliminate the problem by using one of the following measures:

Relocate either this product or the device that is being affected by the interference.

Utilize power outlets that are on different branch (circuit breaker or fuse) circuits or install AC line filter/s.

In the case of radio or TV interference, relocate/reorient the antenna. If the antenna lead-in is 300 ohm ribbon lead, change the lead-in to coaxial type cable.

If these corrective measures do not produce satisfactory results, please contact the local retailer authorized to distribute this type of product. If you can not locate the appropriate retailer, please contact Yamaha Electronics Corp., U.S.A. 6660 Orangethorpe Ave, Buena Park, CA 90620.

The above statements apply ONLY to those products distributed by Yamaha Corporation of America or its subsidiaries.

We Want You Listening For A Lifetime

YAMAHA and the Electronic Industries Association's Consumer Electronics Group want you to get the most out of your equipment by playing it at a safe level. One that lets the sound come through loud and clear without annoying blaring or distortion – and, most importantly, without affecting your sensitive hearing. Since hearing damage from loud sounds is often undetectable until it is too late, YAMAHA and the Electronic Industries Association's Consumer Electronics Group recommend you to avoid prolonged exposure from excessive volume levels.



ENGLISH

INTRODUCTION

Thank you for purchasing this YAMAHA product. We hope it will give you many years of trouble-free enjoyment. For the best performance, read this manual carefully. It will guide you in operating your YAMAHA product.

FEATURES

- High Performance Auto-Reverse Tape Deck
- Dolby B/C Type Noise Reduction
- Applicable to Metal Tape Recording
- Synchronized Recording
- Automatic Dubbing Function
- REC/PLAY Level Meters with Peak Hold Function

This unit, KX-E100 is one of the YAMAHA E100 series components.

SUPPLIED ACCESSORIES

- RCA Pin Cable x2
- System Control Cable x1

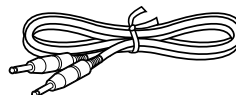
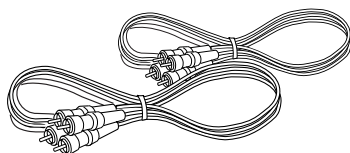

CONTENTS

| | | | |
|---|---|----------------------------------|---|
| PRECAUTIONS | 3 | OPERATIONS | |
| NAMES OF CONTROLS AND FUNCTIONS | | Playback | 6 |
| Front panel | 4 | Recording | 7 |
| Display | 4 | ADDITIONAL INFORMATION | |
| GETTING STARTED | | Troubleshooting | 8 |
| Connecting the unit to the receiver RX-E100 and | | Notes about cassette tapes | 9 |
| CD player CDX-E100 | 5 | Specifications | 9 |

Dolby B/C Type Noise Reduction

Dolby noise reduction is extremely effective in reducing undesirable background hiss on tapes. This unit incorporates Dolby B/C type noise reduction systems. The conventional Dolby B-type noise reduction provides approximately 8 dB improvement in S/N ratio and C-type adds additional improvement over the B-type. The noise reduction is applied to both recording and playback; be sure that the same noise reduction is used on recording and playback. Pressing **DOLBY NR** switches between Dolby B, C and OFF.

Dolby noise reduction manufactured under license from Dolby Laboratories Licensing Corporation.
“DOLBY” and the double-D symbol  are trademarks of Dolby Laboratories Licensing Corporation.

CAUTIONS

- To assure the finest performance, please read this manual carefully. Keep it in a safe place for future reference.
- Install your unit in a well ventilated, cool, dry, clean place – away from windows, heat sources, vibration, dust, moisture, or cold. To avoid humming sounds, locate the unit away from other electrical appliances, motors, and transformers. To prevent fire or electrical shock, do not expose to rain and water.
- Do not operate the unit upside-down. It may overheat, possibly causing damage.
- Never open the cabinet. If something drops into the set, contact your dealer.
- Do not use force on switches, knobs or cords.
- When not planning to use this unit for long periods of time (i.e., vacation, etc.), disconnect the AC power plug from the wall outlet.
- Grounding or polarization – Precautions should be taken so that the grounding or polarization of the unit is not defeated.
- Do not clean the unit with chemical solvents; this might damage the finish. Use a clean, dry cloth.
- Be sure to read the “Troubleshooting” section on common operating errors before concluding that your unit is faulty.
- Do not place another component on top of this unit, as damage or discoloration on the surface of the unit may result.
- To prevent damage by lightning, disconnect the power cord from the wall outlet during an electrical storm.
- When disconnecting the power cord from the wall outlet, grasp the plug; do not pull the cord.
- Do not plug the AC power cord to the wall outlet before you finish all connections.
- The voltage to be used must be the same as that specified on this unit. Using this unit with a higher voltage than that which is specified is dangerous and may result in a fire or other type of accident causing damage. YAMAHA will not be held responsible for any damage resulting from use of this unit with a voltage other than that which is specified.
- Never allow metallic items (e. g. screwdrivers, tools, etc.) to come near the record/playback head assembly. Doing so may not only scratch or damage the head’s mirror-smooth finish, but also change the magnetic characteristics of the heads, causing a deterioration in reproduction quality.
- Although the record/playback head used in this unit is a high quality head with outstanding reproduction characteristics, it can become dirty through the use of old tapes or from dust accumulation over time. This can have a serious effect on reproduction quality.
Clean the heads regularly with one of the commonly available head cleaners or with an appropriate cleaning solution.

WARNING

To reduce the risk of fire or electric shock, do not expose this appliance to rain or moisture.

To avoid electrical shock, do not open the cabinet. Refer servicing to qualified personnel only.

This unit is not disconnected from the AC power source as long as it is connected to the wall outlet, even if this unit itself is turned off. This state is called the standby mode. In this state, this unit is designed to consume a very small quantity of power.

VOLTAGE SELECTOR (General model only)

The voltage selector (on the rear panel of this unit) must be correctly set to the voltage used locally before making any connection to the AC power supply.

NOTE

Please check the copyright laws in your country to record from records, compact discs, radio, etc. Recording of copyright material may infringe copyright laws.

For Canadian Customers

To prevent electric shock, match wide blade of plug to wide slot and fully insert.

This Class B digital apparatus complies with CANADIAN ICES-003

Front panel

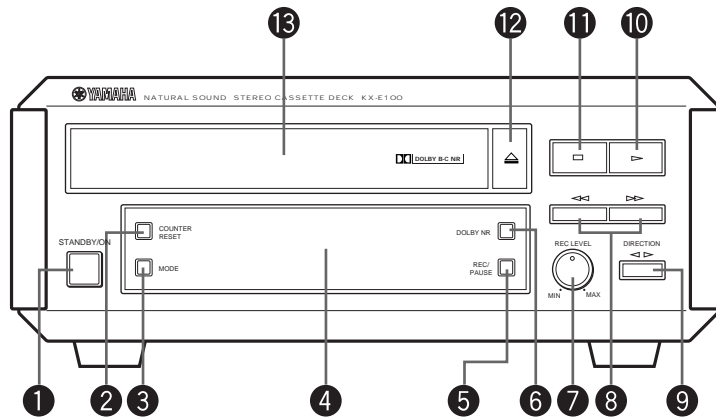

- ① **STANDBY/ON** (p.6)
- ② **COUNTER RESET** (p.7)
- ③ **MODE** (p.6)
- ④ Multi-information display (p.4)
- ⑤ **REC/PAUSE** (p.7)
- ⑥ **DOLBY NR** (p.2)
- ⑦ **REC LEVEL** (p.7)
- ⑧ << / >> (Rewind, Music search backward/
Fast-forward, Music search forward) (p.6)
- ⑨ **DIRECTION** <> (p.6)
- ⑩ ▷ (Play) (p.6)
- ⑪ □ (Stop) (p.6)
- ⑫ ≡ (Open/Close) (p.6)
- ⑬ Tape tray (p.6)

Display

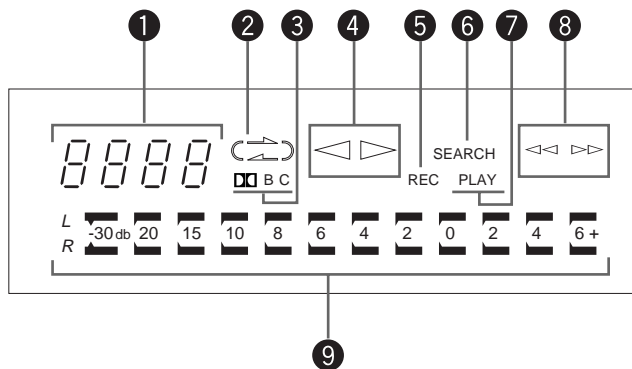

- ① Counter display
- ② Reverse mode indicator
- ③ Dolby Noise Reduction indicator
- ④ Direction indicator
- ⑤ **REC** indicator
- ⑥ Music **SEARCH** indicator
- ⑦ **PLAY** indicator
- ⑧ Rewind/Fast-forward indicator
- ⑨ **REC/PLAY** level indicator

Connecting the unit to the receiver RX-E100 and CD player CDX-E100

Never plug the AC power cord into the wall outlet until all other connections are completed.

Follow the steps as shown below to connect the unit to the receiver (RX-E100), CD player (CDX-E100), and MD recorder (MDX-E100) using the supplied accessories.

- 1** Connect **A** to **A**, and **B** to **B** using the RCA pin cables.
Insert the plugs into the jacks of the same colour.
 - The two RCA pin cables are the same, so you can connect **A** or **B** using either cord.
- 2** Connect the unit and the CDX-E100 (or MDX-E100) with the system control cable.
- 3** Connect the AC power cord to **AC OUTLET** of CDX-E100 (or MDX-E100) (except for U.K. model).

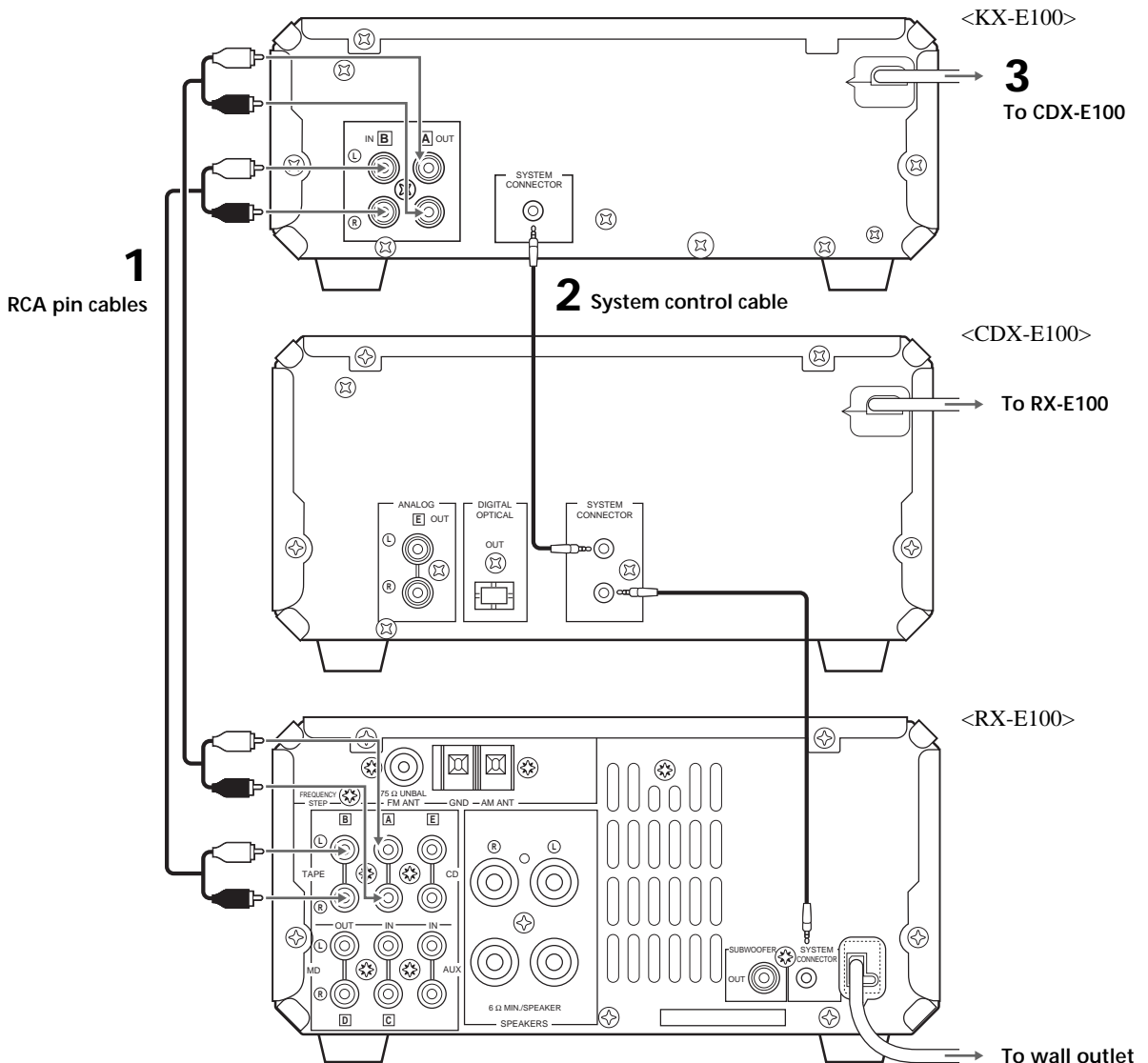

Playback

You can use any type of tape, since the unit automatically detects the tape type.

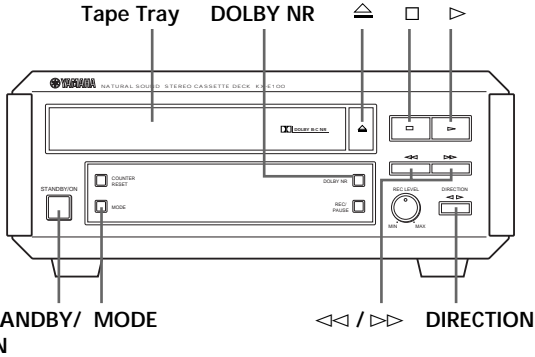

- 1 Press **STANDBY/ON** to turn on this unit and also RX-E100.
- 2 Set RX-E100 to cassette deck function mode.
- 3 Press \triangle to open the tape tray and place a recorded tape on the tray.

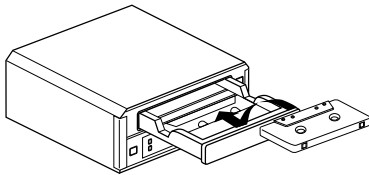

- 4 Press \triangle to close the tape tray.
- 5 Press **MODE** to select the reverse mode. Each time you press **MODE**, the reverse mode changes and the corresponding mode indicator lights up as follows:

\rightleftarrows : One side of the tape is played back.



\rightrightarrows : Both sides of the tape are played back.



\rightleftarrows : Both sides of the tape are played back up to 8 times continuously.

- 6 Press **DIRECTION** to change the direction of the tape.

- If you place the tape on the tray with side A upward, \triangleright indicates playing side A and \triangleleft indicates playing side B.

- 7 Select the noise reduction type using **DOLBY NR** if necessary.
- 8 Press \triangleright to start play.

To stop play

Press \square .

To eject a tape

Press \triangle to open the tape tray and remove the tape from the tray.

To adjust the volume level

Use the volume control of RX-E100.

To fast-forward or rewind the tape

Press $\triangleright\triangleright$ or $\triangleleft\triangleleft$ to fast-forward or rewind the tape during stop mode.

To search for the beginning of a selection

Press $\triangleright\triangleright$ or $\triangleleft\triangleleft$ to search for the beginning of the next or current selection during play mode.

Notes

- The blank interval between selections must be at least 4 seconds long.
- The search function may not operate properly with tapes recorded at a low recording level or which have excessive noise.
- When you play the beginning part or end part of the tape, the search function may not work correctly.

Recording

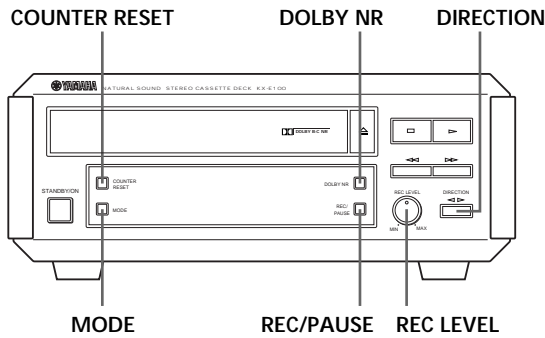

- 1 Set the recording mode of RX-E100 and other components.
- 2 Press **MODE** to select the reverse mode. Each time you press **MODE**, the reverse mode changes and the corresponding mode indicator lights up as follows:
 - ⇐ : One side of the tape is recorded.
 - ↑
 - ⇒ : Both sides of the tape are recorded.
- 3 Press **DIRECTION** to change the direction of the tape.
 - If you place the tape on the tray with side A upward, ▷ indicates recording side A and ◁ indicates recording side B.
- 4 Press **REC/PAUSE**. The unit turns into standby mode for recording and the REC indicator flashes.
- 5 Adjust the recording level by turning **REC LEVEL**. For the best results, play the loudest passage of the source to be recorded and watch the recording level meter in the display. Adjust **REC LEVEL** so that the highest peak causes the +2 dB level indicators to flicker. When recording a CD, use Peak Level Search on CDX-E100 for the optimum adjustment.
- 6 Select the noise reduction type using **DOLBY NR** if necessary.
- 7 Press ▷.

- 8 Start playing the source component.
 - Synchronized start is possible if you have connected the CD player, CDX-E100 or MD recorder, MDX-E100 to this unit. Press ▷/⏏ on MDX-E100 or CDX-E100 after step 6. Recording begins automatically.

To pause recording

Press **REC/PAUSE**.

To resume recording, press ▷.

To stop recording

Press □.

Note

- When you record on ◁ direction of the tape, the unit stops recording after recording the side of the tape regardless of the reverse mode setting in step 2.

The tape counter

The tape counter is useful for searching and locating a certain point on the tape. Pressing **COUNTER RESET** will reset the tape counter to “0000”.

Troubleshooting

If the unit fails to operate normally, check the following points to determine whether the fault can be corrected by the simple measures suggested. If it cannot be corrected, or if the fault is not listed in the SYMPTOM column, disconnect the power cord and contact your authorized YAMAHA dealer or service center for help. When taking the service, the RX-E100 /CDX-E100 may be needed. For details, contact your authorized YAMAHA dealer or service center.

| SYMPTOM | CAUSE | REMEDY |
|---|--|---|
| The unit does not work normally. | There is an influence of strong external noise (lightning, excessive static electricity, etc.) or a misoperation was performed while using the unit. | Turn the unit off and disconnect the AC power cord from the wall outlet. After about 30 seconds have passed, connect the power and try again. |
| Tape does not move during playback or recording. | Slack tape wrapped around pinch roller. | Take up slack with a pencil before using. |
| Cannot record. | Erasure prevention tab is broken off. | Replace tape or cover erasure prevention hole with adhesive tape. |
| | Head is dirty. | Clean heads. |
| Sound is distorted or fades out. | Head is dirty. | Clean heads. |
| | Tape is worn. | Replace the tape. |
| Poor sound quality | Tape encoded with DOLBY NR B/C is played back with the unit's DOLBY NR OFF or vice versa. | Select an appropriate DOLBY NR type. The same noise reduction type should be used both on recording and playback. |
| | Tape encoded with DOLBY NR B is played back with the unit's DOLBY NR C or vice versa. | |
| | Head is dirty. | Clean heads. |
| Stereo balance is poor. | Head is dirty. | Clean heads. |
| Excessive noise | Head has become magnetized. | Demagnetize heads with head eraser. |
| | Tape is worn. | Replace the tape. |
| Tape travel stops in middle of playback or recording. | Slack tape coming out of cassette shell. | Take up slack by turning reels with a pencil. |
| | Tape is worn. | Replace the tape. |
| The CD synchronized recording function does not work. | System cable is not connected. | Connect the unit and the RX-E100 / CDX-E100 with the system cable firmly. |
| Cannot search for the beginning of desired track of the tape | Silent gaps between tracks are too short. | The function of searching for the beginning of a desired track does not operate unless the silent gaps between tracks are at least four seconds long. |
| | Excessively soft passages in the middle of selections. | |
| | Conversation, or noise, etc. is recorded. | |

Notes about cassette tapes

Cassette tapes

- YAMAHA does not recommend the use of 120 minute length cassettes since the extreme thinness of the tape makes them susceptible to mechanical and recording problems.
- Since the unit automatically detects the tape type, you can use any type of tape.

Protecting your recordings

- Tapes have removable tabs, which prevent accidental recording or erasing from taking place. Removing the tab on the top left protects the side facing you from erasure. Cover the tab holes with adhesive tape to erase or record again.

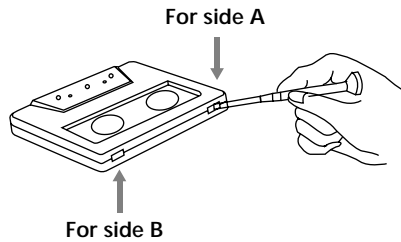

Taking up slack in the tape

- Before loading a tape on the tray, tighten the slack portion of tape with a pen or pencil.

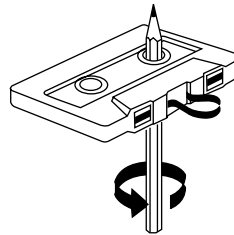

Maintenance

- Dirty heads, capstans, and pinch rollers can cause poor sound and tape jams. Clean these parts with a commercially available cleaning tape.

Specifications

| | |
|-----------------------------|-----------------------------------|
| Type | Auto reverse stereo cassette deck |
| Frequency Response (-20 dB) | |
| Type 1 (Normal) | 30 to 15,000 Hz |
| Type 2 (High) | 30 to 16,000 Hz |
| Type 4 (Metal) | 30 to 18,000 Hz |
| Wow and Flutter | 0.09%, W.RMS |
| Signal-to-Noise Ratio | 58 dB (Dolby NR OFF) |
| | 66 dB (Dolby B NR ON) |
| | 74 dB (Dolby C NR ON) |
| Harmonic Distortion | 1.0% |

General

| | |
|----------------------------------|--------------------------------|
| Power supply | |
| [U.S.A. and Canada models] | AC 120 V, 60 Hz |
| [Australia model] | AC 240 V, 50 Hz |
| [U.K. and Europe models] | AC 230 V, 50 Hz |
| [General model] | AC 110~120/220~240 V, 50/60 Hz |
| Power consumption | 12 W |
| Dimensions (W x H x D) | 217 x 88 x 293 mm |
| Weight | 3.0 kg |
| Accessories | RCA Pin Cable x2 |
| | System Control Cable |

Specifications are subject to change without notice.



YAMAHA ELECTRONICS CORPORATION, USA 6660 ORANGETHORPE AVE., BUENA PARK, CALIF. 90620, U.S.A.
YAMAHA CANADA MUSIC LTD. 135 MILNER AVE., SCARBOROUGH, ONTARIO M1S 3R1, CANADA
YAMAHA ELECTRONIK EUROPA G.m.b.H. SIEMENSSTR. 22-34, 25462 RELINGEN BEI HAMBURG, F.R. OF GERMANY
YAMAHA ELECTRONIQUE FRANCE S.A. RUE AMBROISE CROIZAT BP70 CROISSY-BEAUBOURG 77312 MARNE-LA-VALLEE CEDEX02, FRANCE
YAMAHA ELECTRONICS (UK) LTD. YAMAHA HOUSE, 200 RICKMANSWORTH ROAD WATFORD, HERTS WD1 7JS, ENGLAND
YAMAHA SCANDINAVIA A.B. J A WETTERGRENS GATA 1, BOX 30053, 400 43 VÄSTRA FRÖLUNDA, SWEDEN
YAMAHA MUSIC AUSTRALIA PTY, LTD. 17-33 MARKET ST., SOUTH MELBOURNE, 3205 VIC., AUSTRALIA

YAMAHA CORPORATION

Printed in Malaysia

UD VIDEO V423620