

# YAMAHA PORTATONE PSR-5700

OWNER'S MANUAL

**Getting Started**

BEDIENUNGSANLEITUNG

**Kurzanleitung**

MODE D'EMPLOI

**Pour commencer**

MANUAL DE INSTRUCCIONES

**Para empezar**

# SPECIAL MESSAGE SECTION

**PRODUCT SAFETY MARKINGS:** Yamaha electronic products may have either labels similar to the graphics shown below or molded/stamped facsimiles of these graphics on the enclosure. The explanation of these graphics appears on this page. Please observe all cautions indicated on this page and those indicated in the safety instruction section.

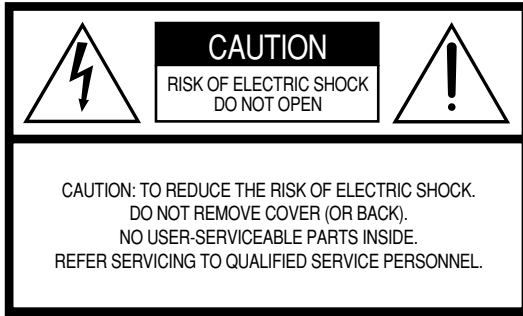

The exclamation point within the equilateral triangle is intended to alert the user to the presence of important operating and maintenance (servicing) instructions in the literature accompanying the product.

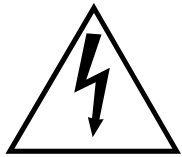

The lightning flash with arrowhead symbol within the equilateral triangle is intended to alert the user to the presence of uninsulated “dangerous voltage” within the product’s enclosure that may be of sufficient magnitude to constitute a risk of electrical shock.

**IMPORTANT NOTICE:** All Yamaha electronic products are tested and approved by an independent safety testing laboratory in order that you may be sure that when it is properly installed and used in its normal and customary manner, all foreseeable risks have been eliminated. DO NOT modify this unit or commission others to do so unless specifically authorized by Yamaha. Product performance and/or safety standards may be diminished. Claims filed under the expressed warranty may be denied if the unit is/has been modified. Implied warranties may also be affected.

**SPECIFICATIONS SUBJECT TO CHANGE:** The information contained in this manual is believed to be correct at the time of printing. However, Yamaha reserves the right to change or modify any of the specifications without notice or obligation to update existing units.

**ENVIRONMENTAL ISSUES:** Yamaha strives to produce products that are both user safe and environmentally friendly. We sincerely believe that our products and the production methods used to produce them, meet these goals. In keeping with both the letter and the spirit of the law, we want you to be aware of the following:

**Battery Notice:** This product MAY contain a small non-rechargeable battery which (if applicable) is soldered in place. The average life span of this type of battery is approximately five years. When replacement becomes necessary, contact a qualified service representative to perform the replacement.

**Warning:** Do not attempt to recharge, disassemble, or incinerate this type of battery. Keep all batteries away from children. Dispose of used batteries promptly and as regulated by applicable laws. Note: In some areas, the servicer is required by law to return the defective parts. However, you do have the option of having the servicer dispose of these parts for you.

**Disposal Notice:** Should this product become damaged beyond repair, or for some reason its useful life is considered to be at an end, please observe all local, state, and federal regulations that relate to the disposal of products that contain lead, batteries, plastics, etc.

**NOTICE:** Service charges incurred due to lack of knowledge relating to how a function or effect works (when the unit is operating as designed) are not covered by the manufacturer’s warranty, and are therefore the owners responsibility. Please study this manual carefully and consult your dealer before requesting service.

**NAME PLATE LOCATION:** The graphic below indicates the location of the name plate. The model number, serial number, power requirements, etc., are located on this plate. You should record the model number, serial number, and the date of purchase in the spaces provided below and retain this manual as a permanent record of your purchase.

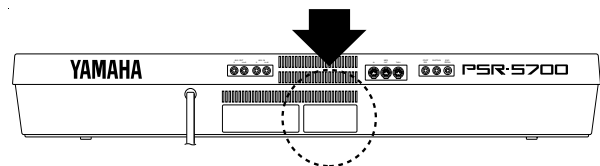

**Model** \_\_\_\_\_

**Serial No.** \_\_\_\_\_

**Purchase Date** \_\_\_\_\_

## ***Congratulations!***

*You are the proud owner of an extraordinary electronic keyboard. The Yamaha PSR-5700 PortaTone combines the most advanced AWM tone generation technology with state-of-the-art digital electronics and features to give you stunning sound quality with maximum musical enjoyment. The Interactive Accompaniment and Super Style Play features, in particular, are brilliant examples of how advanced technology can significantly expand your musical horizons.*

*In order to make the most of your PortaTone's features and vast performance potential, we urge you to read the manuals thoroughly while trying out the various features described. Keep the manuals in a safe place for later reference.*

## **Contents**

---

<b>About the PSR-5700 Manuals</b> .....	3
<b>Taking Care of Your PortaTone</b> .....	4
<b>Nomenclature</b> .....	6
<b>Connections &amp; Music Stand</b> .....	8
<b>The Demonstration</b> .....	10
<b>Playing the PSR-5700</b> .....	11
Selecting & Playing Voices .....	11
Keyboard Percussion .....	14
<b>Transposition, Tuning, and Octave Change</b> .....	15
TRANPOSE/TUNE .....	15
OCTAVE CHANGE .....	16
<b>Voice Registration</b> .....	17
<b>Using the Accompaniment Section</b> .....	18
Interactive Accompaniment .....	24
Using the Disk Style on the Supplied Data Disk .....	25
<b>Super Style Play</b> .....	26
<b>Using the Pads</b> .....	28
The MULTI Mode .....	28
The PERC Mode .....	32
The TEMPO Mode .....	34
<b>Expression &amp; Effects</b> .....	36
<b>Panel Registration</b> .....	38
<b>Playing DOC (Disk Orchestra Collection) Disks</b> .....	40
<b>Troubleshooting</b> .....	42
<b>Options</b> .....	42
<b>Index</b> .....	43
<b>Fingering Chart</b> .....	178

# About the PSR-5700 Manuals

The PSR-5700 comes with two manuals: “Getting Started” (this manual), and the “Advanced Features” manual.

## ■ The “Getting Started” Manual

This, as its name suggests, is the manual you should start with. The “Getting Started” manual will teach you everything you need to basically play and enjoy the PSR-5700, concentrating on the keys and controls that you’ll use most frequently.

### The Getting Started manual covers:

- Playing the demonstration.
- Selecting and playing voices.
- Tuning and transposition.
- Voice registration.
- Using the auto accompaniment functions.
- The multi, tempo, and percussion pads.
- Expression and effects.
- The panel registration feature.
- Playing Disk Orchestra Collection disks.

Go through the Getting Started manual first!

## ■ The “Advanced Features” Manual

The Advanced Features manual is the manual you’ll want to refer to after you gain initial familiarity with the PSR-5700 — i.e. after you’ve carefully gone through the Getting Started manual. As its name suggests, the Advanced Features manual concentrates on the many advanced features and utility functions provided by the PSR-5700.

### The Advanced Features manual covers:

- The sequencer.
- The custom accompaniment programmer.
- Custom voice editing.
- The PSR-5700’s digital effects.
- Floppy disk operations.
- And a range of other functions including MIDI operations and General MIDI Level 1 protocol compatibility.

Unlike the Getting started manual which is designed to be read through from beginning to end, the Advanced Features manual allows you to directly reference information on individual features and functions.

## ■ Icons

The following simple icons are used throughout this manual to draw attention to important points and information where necessary. The icons also make it easier to differentiate between information that you should read immediately and information that can be skipped until later, hopefully helping you to become familiar with the PSR-5700 in the quickest, most efficient manner possible.



CAUTION

This icon warns of possible hardware damage, software malfunction, or any other serious problem that may occur due to improper operation or set up.



IMPORTANT

This icon marks information that you must read — i.e. important steps or procedures that are essential for proper, efficient, or easy operation.



DETAIL

The magnifying-glass icon indicates information that may not be essential for general operation, but is a more detailed explanation of a feature, a description of the principle involved, etc. You can skip this information if full details are not required immediately.



MUSICAL NOTE

Suggestions as to how a feature or function can be applied musically are identified by this icon.



HINT

Hints or ideas that are not specifically musical but may make operation easier or more interesting are marked by the light-bulb icon.

# Taking Care of Your PortaTone

Your PortaTone will give you years of playing pleasure if you follow the simple rules given below:

## ■ Location

Do not expose the instrument to the following conditions to avoid deformation, discoloration, or more serious damage.

- Direct sunlight (e.g. near a window).
- High temperatures (e.g. near a heat source, outside, or in a car during the daytime).
- Excessive humidity.
- Excessive dust.
- Strong vibration.

## ■ Power Supply

- Turn the power switch OFF when the instrument is not in use.
- The power supply cord should be unplugged from the AC outlet if the instrument is not to be used for an extended period of time.
- Unplug the instrument during electric storms.
- Avoid plugging the instrument into the same AC outlet as appliances with high power consumption, such as electric heaters or ovens. Also avoid using multi-plug adapters since these can result in reduced sound quality, operation errors, and possibly damage.

## ■ Turn Power OFF When Making Connections

- To avoid damage to the instrument and other devices to which it is connected (a sound system, for example), turn the power switches of all related devices OFF prior to connecting or disconnecting audio and MIDI cables.

## ■ Handling and Transport

- Never apply excessive force to the controls, connectors or other parts of the instrument.
- Always unplug cables by gripping the plug firmly, not by pulling on the cable.
- Disconnect all cables before moving the instrument.
- Physical shocks caused by dropping, bumping, or placing heavy objects on the instrument can result in scratches and more serious damage.

## ■ Cleaning

- Clean the cabinet and panel with a dry soft cloth.
- A slightly damp cloth may be used to remove stubborn grime and dirt.
- Never use cleaners such as alcohol or thinner.
- Avoid placing vinyl objects on top of the instrument (vinyl can stick to and discolor the surface).

## ■ Electrical Interference

- This instrument contains digital circuitry and may cause interference if placed too close to radio or television receivers. If this occurs, move the instrument further away from the affected equipment.

## ■ Data Backup

- Internal data (e.g. sequencer data) is retained in memory even if the power switch is turned OFF. If the power is not turned ON for periods longer than about a week, however, memory data will be lost. Save all important data to disk before turning off for longer periods.
- Internal memory data can be corrupted due to incorrect operation. Be sure to “save” important data to a floppy disk frequently so you have a backup to revert to if something happens to damage the data in memory. Also note that magnetic fields can damage data on the disk, so it is advisable to make a second back-up copy of disks that contain very important data, and keep backup disks in a safe place away from stray magnetic fields (i.e. away from speakers, appliances containing motors, etc.).

## ■ Handle Floppy Disks and the Disk Drive With Care

- Do not bend or apply pressure to the floppy disk. Do not open the shutter and touch the surface of the floppy disk inside.
- Do not expose the disk to high temperatures. (e.g. direct sunlight)
- Use only 3.5” 2DD type floppy disks.
- Do not expose the disk to magnetic fields. Magnetic fields can partially or totally erase data on the disk, rendering the disk unreadable.
- To eject a floppy disk, press the eject button slowly as far as it will go then, when the disk is fully ejected, remove it by hand.  
The disk may not be ejected properly if the eject button is pressed too quickly, or it is not pressed in as far as it will go (the eject button may become stuck in a half-pressed position and the disk extends from the drive slot by only a few millimeters). If this happens, do not attempt to pull out the partially ejected disk. Using force in this situation can damage the disk-drive mechanism or the floppy disk. To remove a partially ejected disk, try pressing the eject button once again, or push the disk back into the slot and then repeat the eject procedure carefully.
- Do not insert anything but floppy disks into the disk drive. Other objects may cause damage to the disk drive or the floppy disk.
- Be sure to remove the floppy disk from the drive when moving the PSR-5700. Moving the instrument while a floppy disk is loaded can damage both the drive and the disk.
- Apply floppy disk labels carefully! Improperly applied disk labels (wrinkled, protruding corners, etc.) can cause the disk to become stuck in the disk drive.

## ■ Service and Modification

- The PSR-5700 contains no user serviceable parts. Opening it or tampering with it in anyway can lead to irreparable damage and possibly electric shock. Refer all servicing to qualified YAMAHA personnel.

YAMAHA is not responsible for damage caused by improper handling or operation.

# Nomenclature

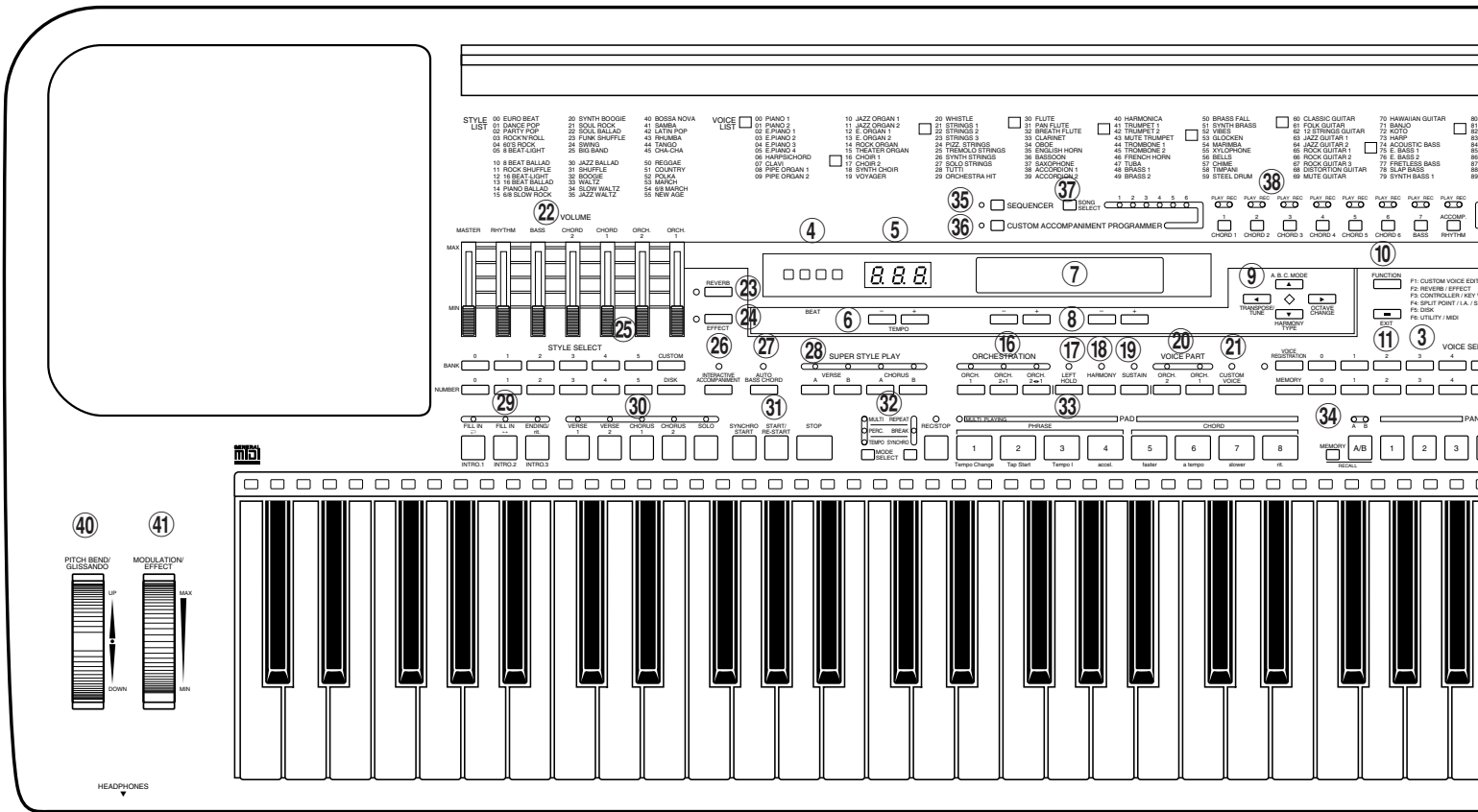

- ① POWER Button ..... [page 10]
- ② DEMO Button ..... [page 10]
- ③ VOICE SELECT Buttons ..... [page 13, 17]  
BANK  
NUMBER  
VOICE REGISTRATION  
MEMORY
- ④ BEAT Display ..... [page 21]
- ⑤ LED Display ..... [page 20]
- ⑥ TEMPO [-] and [+] Buttons ..... [page 20]
- ⑦ Liquid Crystal Display (LCD) ..... [page 10, 13, 20]
- ⑧ Left and Right [-] and [+] Buttons [page 10, 13, 20]
- ⑨ Display Scroll/Function Buttons  
ABC MODE (▲) ..... [page 18]  
HARMONY TYPE (▼) ..... [page 36]  
TRANSPOSE/TUNE (◀) ..... [page 15]  
OCTAVE CHANGE (▶) ..... [page 16]
- ⑩ FUNCTION Button . [Advanced Features, page 26]
- ⑪ EXIT Button ..... [Advanced Features, page 26]
- ⑫ TO DISK Button ..... [Advanced Features, page 42]
- ⑬ DISK IN USE Lamp ..... [page 40]
- ⑭ FROM DISK Button [Advanced Features, page 44]
- ⑮ DISK ORCHESTRA/GENERAL MIDI Button  
..... [page 40, Advanced Features, page 50]
- ⑯ ORCHESTRATION Buttons and Indicators  
..... [page 12]  
ORCH. 1  
ORCH. 2+1  
ORCH. 2◀▶1
- ⑰ LEFT HOLD Button ..... [page 36]
- ⑱ HARMONY Button ..... [page 36]
- ⑲ SUSTAIN Button ..... [page 36]
- ⑳ VOICE PART Buttons and Indicators ..... [page 13]  
ORCH. 2  
ORCH. 1
- ㉑ CUSTOM VOICE Button and Indicator  
..... [Advanced Features, page 27]
- ㉒ VOLUME Controls ..... [page 10, 11, 13]  
MASTER  
RHYTHM  
BASS  
CHORD 2  
CHORD 1  
ORCH. 2  
ORCH. 1

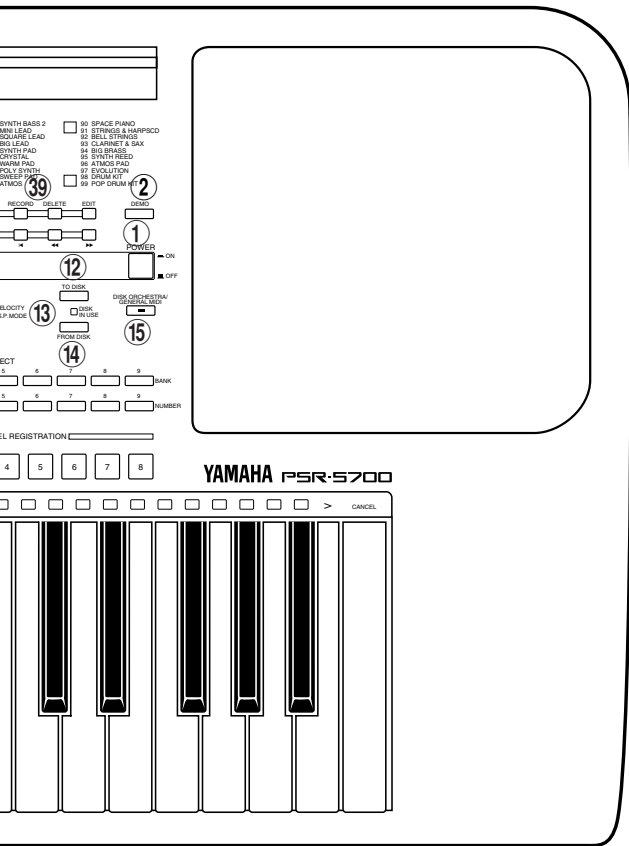

YAMAHA PSR-5700

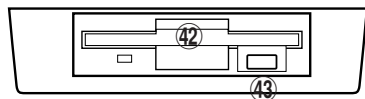

- 23 REVERB Button ..... [page 37]
- 24 EFFECT Button ..... [page 37]
- 25 STYLE SELECT Buttons ..... [page 20]
  - BANK
  - NUMBER
  - CUSTOM
  - DISK
- 26 INTERACTIVE ACCOMPANIMENT Button and Indicator ..... [page 24]
- 27 AUTO BASS CHORD Button and Indicator ..... [page 18]
- 28 SUPER STYLE PLAY Buttons and Indicators ..... [page 26]
  - VERSE A
  - VERSE B
  - CHORUS A
  - CHORUS B

- 29 Fill-in, Intro, and Ending Buttons ..... [page 21, 23]
  - FILL IN↷/INTRO 1
  - FILL IN↔/INTRO 2
  - ENDING/rit./INTRO 3
- 30 Verse, Chorus, and Solo Buttons ..... [page 22]
  - VERSE 1
  - VERSE 2
  - CHORUS 1
  - CHORUS 2
  - SOLO
- 31 Accompaniment Control Buttons ..... [page 21]
  - SYNCHRO START
  - START/RE-START
  - STOP
- 32 PAD MODE SELECT Buttons and Indicators ..... [page 28~35]
- 33 PAD Buttons ..... [page 28~35]
- 34 PANEL REGISTRATION Buttons ..... [page 38]
- 35 SEQUENCER Button .. [Advanced Features, page 3]
- 36 CUSTOM ACCOMPANIMENT PROGRAMMER Button ..... [Advanced Features, page 15]
- 37 SONG SELECT Button ..... [Advanced Features, page 3]
- 38 Sequencer Track/Custom Accompaniment Programmer Track Buttons ..... [Advanced Features, page 4~6, 16~17]
  - 1 through 6/CHORD 1 through 6
  - 7/BASS
  - ACCOMP./RHYTHM
- 39 Sequencer/Custom Accompaniment Programmer Control Buttons ..... [Advanced Features, page 4~6, 16~17]
  - RECORD
  - DELETE
  - EDIT
  - ◀ (Top)
  - ◀◀ (Rewind)
  - ▶▶ (Forward)
- 40 PITCH BEND/GLISSANDO Wheel ..... [page 37]
- 41 MODULATION/EFFECT Wheel ..... [page 37]
- 42 Disk Drive ..... [page 25, 40]
- 43 Disk Eject Button ..... [page 40]



# Connections & Music Stand

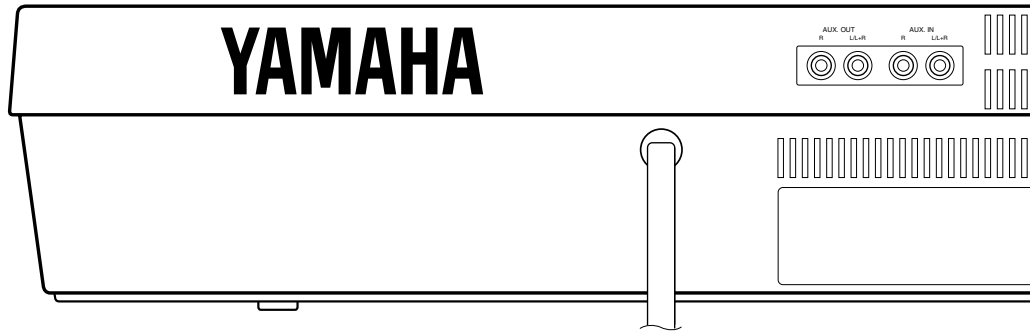
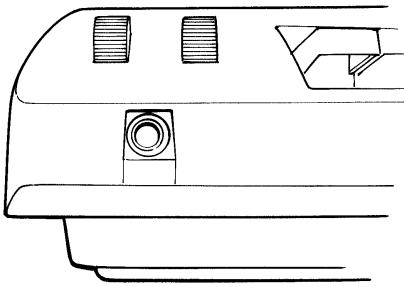

## ① The HEADPHONES Jack

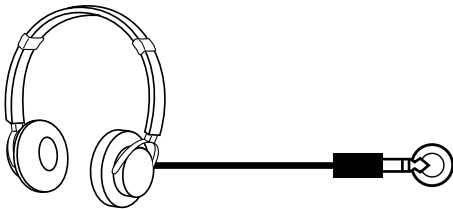

A standard pair of stereo headphones can be plugged in here for private practice or late-night playing. The internal stereo speaker system is automatically shut off when a pair of headphones is plugged into the HEADPHONES jack.

## ② The AUX. OUT L/L+R and R Jacks

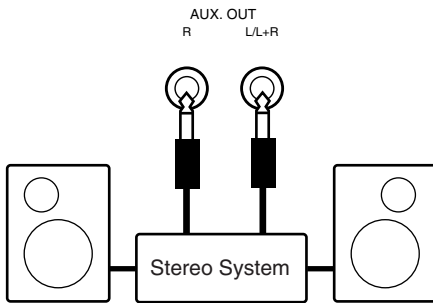

The rear-panel AUX. OUT L/L+R and R jacks deliver the output of the PSR-5700 for connection to a keyboard amplifier, stereo sound system, a mixing console, or tape recorder. If you will be connecting the PSR-5700 to a monaural sound system, use only the L/L+R jack. When a plug is inserted into the L/L+R jack only, the left- and right-channel signals are combined and delivered via the L/L+R jack so you don't lose any of the PSR-5700 sound.



*To prevent damage to the internal circuitry, the AUX. OUT jack signal must never be returned to the AUX. IN jacks, either directly or through external equipment.*

## ③ AUX. IN L/L+R and R Jacks

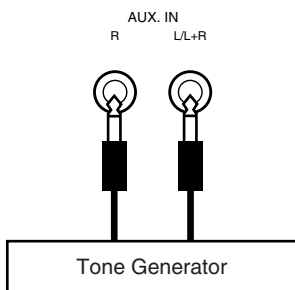

These jacks are intended primarily for use with external audio sources such as tone generators, drum machines, CD players, and similar equipment. The signal received via the AUX. IN L and R jacks is reproduced via the PSR-5700's internal stereo amplifier and speaker system. If you will be connecting a monaural source to the PSR-5700, use only the L/L+R jack. When a plug is inserted into the L/L+R jack only, the monaural input signal is fed to both the left and right channels of the PSR-5700 stereo sound system. Please note that the PSR-5700 MASTER VOLUME control does not affect the level of the signal delivered to external equipment.

## ④ FOOT SW. Jack

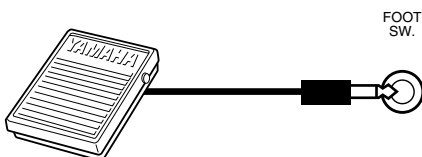

The supplied FC5 footswitch or a second (optional) footswitch connected to this jack can be used to control a range of important functions. Refer to the "FOOT SWITCH SELECT" function described on page 37 of the Advanced Features manual.

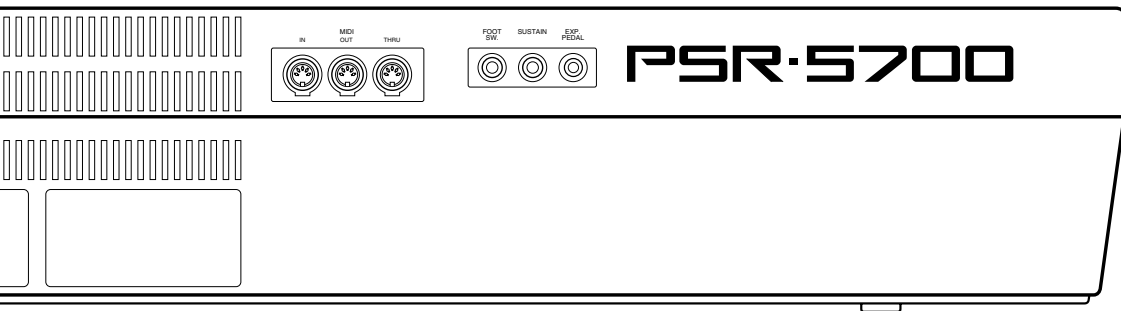

### ⑤ SUSTAIN Jack

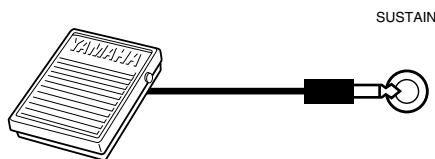

The PSR-5700 comes with an FC5 footswitch that should be connected here for foot sustain control. The footswitch functions like the damper pedal on a piano — press for sustain, release for normal sound.

### ⑥ EXP. PEDAL Jack

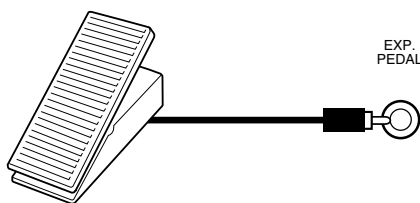

An optional Yamaha EP-1 Expression Pedal can be connected to this jack to allow foot expression (swell) or effect control. Please note that when the pedal is used for expression control, no sound will be produced if the expression pedal is set to the minimum position.

### ⑦ MIDI IN, THRU and OUT Connectors

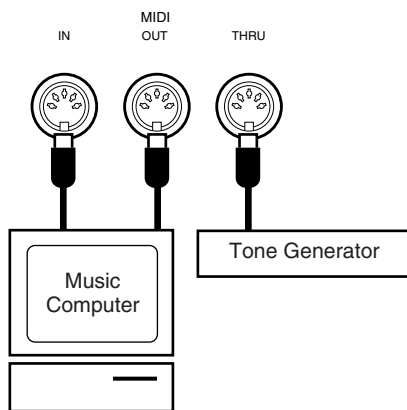

The MIDI IN connector receives MIDI data from an external MIDI device (such as a MIDI sequencer) which can be used to control the PSR-5700. The MIDI THRU connector re-transmits any data received at the MIDI IN connector, allowing “chaining” of several MIDI instruments or other devices. The MIDI OUT connector transmits MIDI data generated by the PSR-5700 (e.g. note and velocity data produced by playing the keyboard).

More details on MIDI are provided on page 50 of the Advanced Features manual.

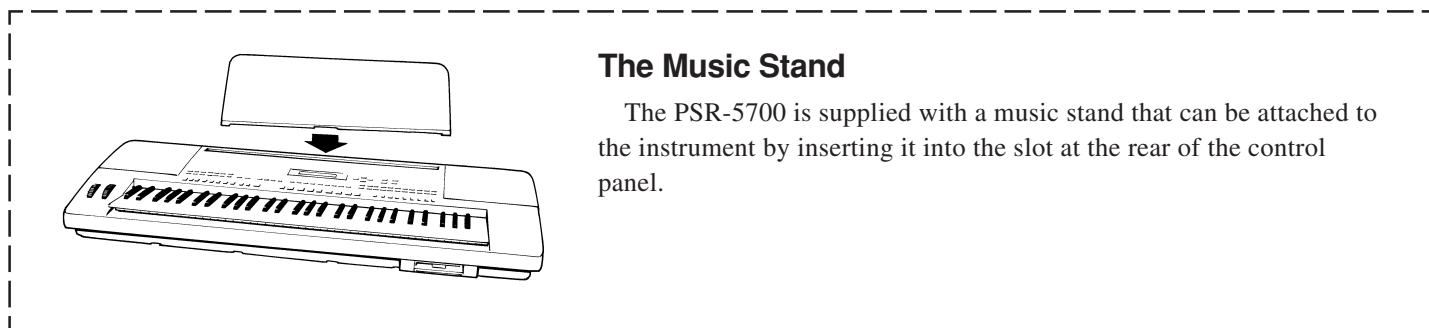

### The Music Stand

The PSR-5700 is supplied with a music stand that can be attached to the instrument by inserting it into the slot at the rear of the control panel.

# The Demonstration

To give you an idea of the PSR-5700's sophisticated capabilities, it is programmed with four demonstration sequences which play automatically.



*The demonstration sequences have been specially programmed for demonstration purposes — it is not possible to reproduce the demonstration sequences 100% using the PSR-5700 sequencer functions.*

## 1 Switch ON

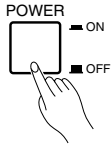

Plug the AC power cord into a convenient AC outlet, then press the [POWER] button to turn the PSR-5700 ON.

```
*** YAMAHA PORTATONE ***
*** PSR-5700 ***
```



```
>00:Piano 1
00: Eurobeat 21: Strings1
```

## 2 Set Initial Volume Levels

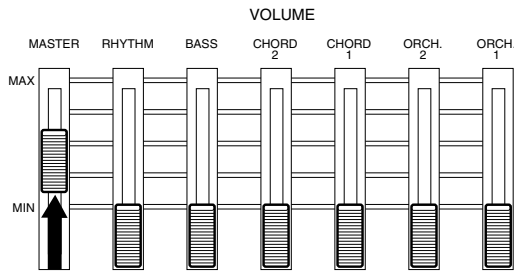

Set the [MASTER] VOLUME control to a position about half way toward the "MAX" setting. You can re-adjust the [MASTER] VOLUME control for the most comfortable overall volume level after playback begins.

## 3 Press the [DEMO] Button

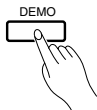

The demonstration will begin playing as soon as you press the [DEMO] button.

The demonstration will play continuously until the [DEMO] button is pressed a second time, or until the accompaniment control [STOP] button is pressed.



*You can select playback of just one of the four demonstration sequences by using the [+] and [-] buttons below "Song=ALL" on the LCD panel while holding the [DEMO] button. Select "Song=1", "Song=2", "Song=3", or Song=4" and then release the [DEMO] button. The selected demonstration will play through to the end and then stop automatically.*

```
PSR-5700 DEMONSTRATION
Song=1 ClubRock
```

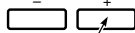

```
PSR-5700 DEMONSTRATION
Playing 1: ClubRock
```

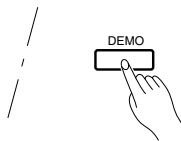

# Playing the PSR-5700

## ■ Before You Begin

Before playing your PSR-5700 for the first time, it might be a good idea to re-initialize it to the original factory settings just in case these have been changed at some point before you receive the instrument. To do this, press the [FUNCTION] button a few times until “F6” appears on the LED display (this is the UTILITY mode). Now press the [▼] button (HARMONY TYPE) to the right of the LCD panel a few times until the following display appears:

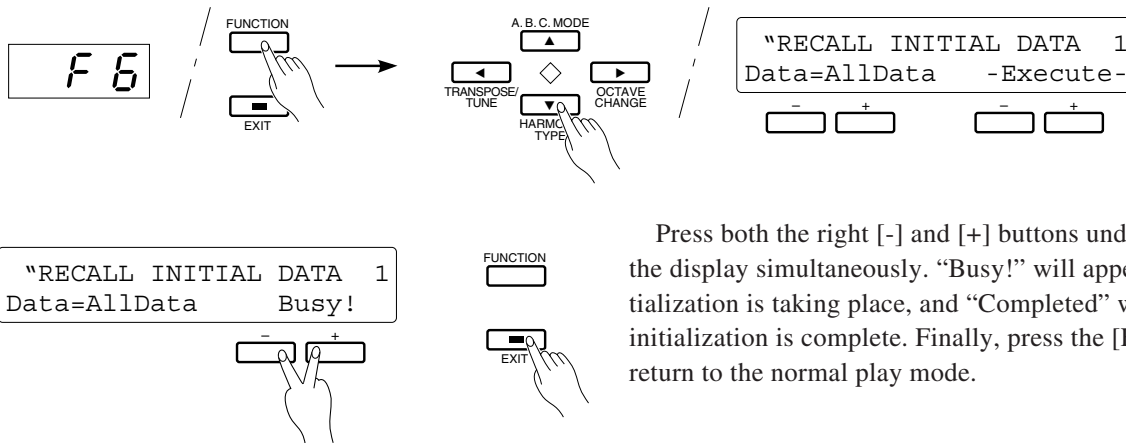

Press both the right [-] and [+] buttons under “-Execute-” on the display simultaneously. “Busy!” will appear while the initialization is taking place, and “Completed” will appear when the initialization is complete. Finally, press the [EXIT] button to return to the normal play mode.

## Selecting & Playing Voices

### 1 Turn Power On and Set Initial Volume

Press the [POWER] button to turn the power ON, and set all seven VOLUME controls about three-quarters of the way toward their MAX settings. You can set the [MASTER] VOLUME control for the most comfortable overall volume level after beginning to play.

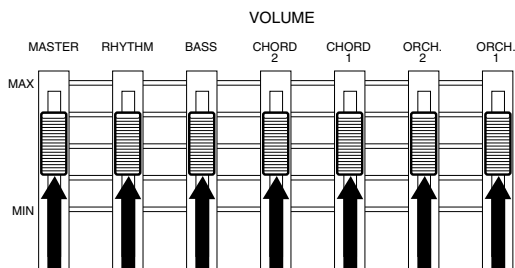

*No sound will be produced if all volume controls other than the MASTER control are set to their minimum positions.*

# Playing the PSR-5700

## 2 Select the Orchestration

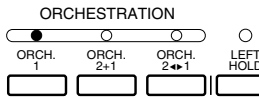

The PSR-5700 has three orchestration modes, selected by the corresponding ORCHESTRATION buttons. The corresponding ORCHESTRATION indicator will light.

- ORCH. 1:** In this mode a single voice — the ORCH. 1 voice — can be played across the entire keyboard.
- ORCH. 2+1:** This is a “dual” mode in which two voices — ORCH. 1 and ORCH. 2 — can be played simultaneously across the entire keyboard.
- ORCH. 2<->1:** This is a “split” mode in which the ORCH. 2 voice is played on the left-hand section of the keyboard (to the left of the “split point” — see “DETAIL” below), while the ORCH. 1 voice is played on the right-hand section of the keyboard. Since two voices are played simultaneously in this mode, the total number of notes that can be played on the keyboard at the same time is reduced.

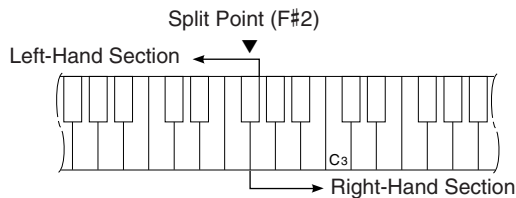

• The lowest key on the keyboard is C1.



The split point for the PSR-5700 is initially set at F#2 when the unit is shipped. This means that when the “ORCH. 2<->1” mode is selected, the ORCH. 2 voice will be played by all keys to the left of and including F#2, while the ORCH. 1 voice will be played on all keys to the right of F#2. You can change the split point to any key desired by using the SPLIT POINT function described on page 40 of the Advanced Features manual.



When the “ORCH.2+1” mode is selected and the same voice is selected for both ORCH. 1 and ORCH. 2, the sound may be slightly different from the normal voice.

## 3 Select a Voice or Voices

The PSR-5700 has 100 voices. A list of the voice names is printed on the control panel for easy reference.

### Voice List

BANK 0	BANK 1	BANK 2	BANK 3	BANK 4
00 PIANO 1	10 JAZZ ORGAN 1	20 WHISTLE	30 FLUTE	40 HARMONICA
01 PIANO 2	11 JAZZ ORGAN 2	21 STRINGS 1	31 PAN FLUTE	41 TRUMPET 1
02 E.PIANO 1	12 E.ORGAN 1	22 STRINGS 2	32 BREATH FLUTE	42 TRUMPET 2
03 E.PIANO 2	13 E.ORGAN 2	23 STRINGS 3	33 CLARINET	43 MUTE TRUMPET
04 E.PIANO 3	14 ROCK ORGAN	24 PIZZ. STRINGS	34 OBOE	44 TROMBONE 1
05 E.PIANO 4	15 THEATER ORGAN	25 TREMOLO STRINGS	35 ENGLISH HORN	45 TROMBONE 2
06 HARPSICHORD	16 CHOIR 1	26 SYNTH STRINGS	36 BASSOON	46 FRENCH HORN
07 CLAVI	17 CHOIR 2	27 SOLO STRINGS	37 SAXOPHONE	47 TUBA
08 PIPE ORGAN 1	18 SYNTH CHOIR	28 TUTTI	38 ACCORDION 1	48 BRASS 1
09 PIPE ORGAN 2	19 VOYAGER	29 ORCHESTRA HIT	39 ACCORDION 2	49 BRASS 2
BANK 5	BANK 6	BANK 7	BANK 8	BANK 9
50 BRASS FALL	60 CLASSIC GUITAR	70 HAWAIIAN GUITAR	80 SYNTH BASS 2	90 SPACE PIANO
51 SYNTH BRASS	61 FOLK GUITAR	71 BANJO	81 MINI LEAD	91 STRINGS & HARPSCD
52 VIBES	62 12 STRING GUITAR	72 KOTO	82 SQUARE LEAD	92 BELL STRINGS
53 GLOCKEN	63 JAZZ GUITAR 1	73 HARP	83 BIG LEAD	93 CLARINET & SAX
54 MARIMBA	64 JAZZ GUITAR 2	74 ACOUSTIC BASS	84 SYNTH PAD	94 BIG BRASS
55 XYLOPHONE	65 ROCK GUITAR 1	75 E.BASS 1	85 CRYSTAL	95 SYNTH LEAD
56 BELLS	66 ROCK GUITAR 2	76 E.BASS 2	86 WARM PAD	96 ATMOS PAD
57 CHIME	67 ROCK GUITAR 3	77 FRETLESS BASS	87 POLY SYNTH	97 EVOLUTION
58 TIMPANI	68 DISTORTION GUITAR	78 SLAP BASS	88 SWEEP PAD	98 DRUM KIT
59 STEEL DRUM	69 MUTE GUITAR	79 SYNTH BASS 1	89 ATMOS	99 POP DRUM KIT

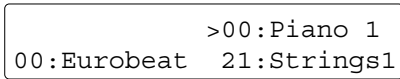
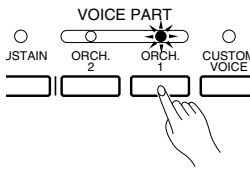

Press the [ORCH. 1] or [ORCH. 2] VOICE PART button, depending on which voice you want to select. The corresponding VOICE PART indicator will light and the “>” cursor on the LCD panel will move to the corresponding voice position.

Use the VOICE SELECT buttons to enter the number of the desired voice. Press a button in the upper row (BANK) to select the “BANK” or “tens” digit, and then a button in the lower row (NUMBER) to select the “ones” digit. For example, to select voice number 73 (HARP), press the BANK [7] button and then the NUMBER [3] button.



If a BANK button is pressed but then no NUMBER button is pressed for more than about 3 seconds, the BANK entry will automatically be cancelled.

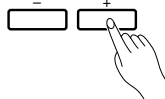
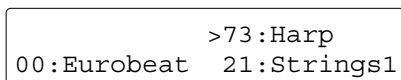
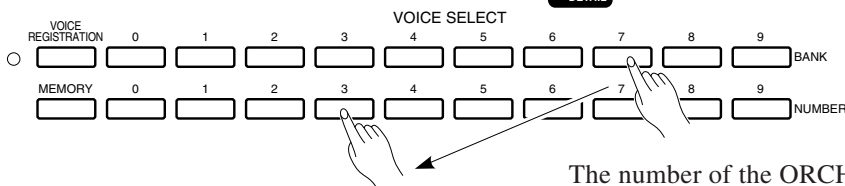

The number of the ORCH. 1 or ORCH. 2 voice can also be decreased (decremented) or increased (incremented) by using the [-] and [+] buttons immediately below the voice names on the LCD panel. Press either button briefly to decrement or increment the voice number by one, or hold the button for continuous decrementing or incrementing.

## 4 Play & Adjust Volume

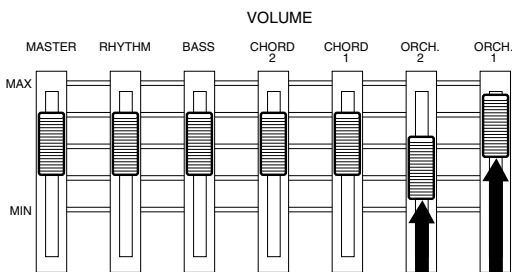

You can now play the selected voice or voices with the selected orchestration. Use the [MASTER] volume control to adjust the overall volume level, and the [ORCH. 1] and [ORCH. 2] VOLUME controls to set the desired balance between the ORCH. 1 and ORCH. 2 voices when either the dual or split orchestration mode is used.



The tone of some voices may change slightly at one or more points on the keyboard. Some voices may also shift octaves on some of the lowest and highest keys of the keyboard. This is due to the way in which the voice waveforms were initially sampled and is not a malfunction.



Voice numbers 90 through 97 are actually combinations of two voices, so the total number of simultaneous notes that can be played when these voices are selected is less than when any of the other voices are selected.

## Keyboard Percussion

>98:Drum Kit  
00: Eurobeat 99: Pop.Drum

When voice number 98 (DRUM KIT) or 99 (POP DRUM KIT) is selected, you can play 59 different drums and percussion instruments on the keyboard. The drums and percussion instruments played by the various keys are marked by symbols above the keys. Some of the instruments in the DRUM KIT and POP DRUM KIT voices sound different even though they have the same name, while others are essentially the same.



*The Transpose, Tune, Sustain, Harmony, Left Hold, Modulation, and Octave Change functions do not affect the keyboard percussion sound.*



*The pitch bend wheel can be used to bend the pitch of the keyboard percussion voices to create unique musical effects, but it has little effect on some percussion sounds.*

	98: DRUM KIT	99: POP DRUM KIT		98: DRUM KIT	99: POP DRUM KIT
Key	Instrument	Instrument	Key	Instrument	Instrument
C1	Applause	Hand Claps	F#3	Conga 1 Low	Conga 2 Low
D♭1	Triangle Close	Triangle Close	G3	Ride Cymbal 1	Ride Cymbal 2
D1	Whistle Low	Whistle Low	A♭3	Conga 1 Hi	Conga 2 Hi
E♭1	Triangle Open	Triangle Open	A3	Ride Cup 1	Ride Cup 2
E1	Whistle Hi	Whistle Hi	B♭3	Conga 1 Mute	Conga 2 Mute
F1	Kick 1	Kick 5	B3	Crash Cymbal 1	Crash Cymbal 1
F#1	Kick 2	Kick 6	C4	Crash Cymbal 2	Crash Cymbal 2
G1	Kick 3	Kick 7	D♭4	Bongo Low	Bongo Low
A♭1	Kick 4	Kick 8	D4	Splash Cymbal	Chinese Cymbal
A1	Tom 1 Bass	Tom Bass	E♭4	Bongo Hi	Bongo Hi
B♭1	Rim Shot 1	Rim Shot 2	E4	March Cymbal	Reverse Cymbal
B1	Tom 1 Low	Tom Low	F4	Surdo	E.Tom Bass
C2	Tom 1 Mid	Tom Mid	F#4	Cabasa	Maracas
D♭2	Snare 1	Snare 7	G4	Tom Brush Low	E.Tom Low
D2	Tom 1 Hi	Tom Hi	A♭4	Vibraslap	Vibraslap
E♭2	Snare 2	Snare 8	A4	Tom Brush Mid	E.Tom Mid
E2	Snare 3	Snare 9	B♭4	Claves	Wood Block
F2	Snare 4	Snare 3	B4	Tom Brush Hi	E.Tom Hi
F#2	Snare 5	Snare 10	C5	Guiro Long	Guiro Long
G2	Snare 6	Snare 11	D♭5	Cuica Low	Scratch Noise Low
A♭2	Brush Hit 1	Brush Hit 2	D5	Guiro Short	Guiro Short
A2	Snare Roll	Snare Roll	E♭5	Cuica Hi	Scratch Noise Hi
B♭2	Snare Brush Squeeze	Snare Brush Squeeze	E5	Tambourine	Running Water
B2	Pedal Hi-Hat 1	Pedal Hi-Hat 2	F5	Cowbell Low	Cowbell Hi
C3	Closed Hi-Hat 1	Closed Hi-Hat 2	F#5	Agogo Low	Agogo Low
D♭3	Timbales Low	Timbales Low	G5	Castanet	Dropping Coin
D3	Open Hi-Hat 1	Open Hi-Hat 2	A♭5	Agogo Hi	Agogo Hi
E♭3	Timbales Hi	Timbales Hi	A5	Finger Snaps	Finger Snaps
E3	Closed Hi-Hat 2	Closed Hi-Hat 3	B♭5	Cross Sticks	Cross Sticks
F3	Open Hi-Hat 2	Open Hi-Hat 3	—	—	—

# Transposition, Tuning, and Octave Change

The most important and fundamental adjustment for any musical instrument is tuning. The TRANSPOSITION, TUNING, and OCTAVE CHANGE functions described below let you control the pitch of the PSR-5700 in a number of ways.

## TRANSPOSE/TUNE

This function allows the overall pitch of the PSR-5700 to be transposed up or down in semitone increments, and fine-tuned in 0.5 Hertz increments.

### 1 Press the [TRANSPOSE/TUNE] Button

Select the TRANSPOSE/TUNE function from the normal play mode by pressing the [TRANSPOSE/TUNE] button (this is the same as the [◀] display scroll button to the right of the LCD panel).

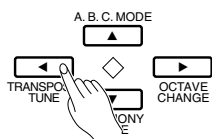
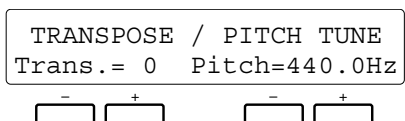

### 2 Set the Transposition and/or Tuning As Required

Use the left [-] and [+] buttons to set the desired degree of transposition, and the right [-] and [+] buttons to set the desired degree of tuning.

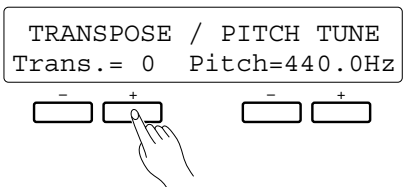

The transpose range is from -6 to +6, allowing a maximum upward or downward transposition of 1/2-octave. A setting of 0 produces the normal pitch. The "0" setting can be instantly recalled by pressing both the left [-] and [+] buttons simultaneously.

The tuning range is from 427.5 Hertz to 452.5 Hertz, adjustable in 0.5-Hertz increments. 440.0 Hertz is "normal" pitch, and this setting can be directly recalled by pressing both the right [-] and [+] buttons simultaneously.

### 3 Press [EXIT] When Done

Press the [EXIT] button to exit from the TRANSPOSE/TUNE function.

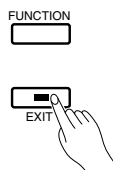

*The TRANSPOSE/TUNE mode is automatically exited if neither of the [-] or [+] buttons are pressed for approximately 10 seconds.*



# Transposition, Tuning, and Octave Change

## OCTAVE CHANGE

This function allows the ORCH. 1 and ORCH. 2 voices to be independently transposed up or down by one octave.

### 1 Press the [OCTAVE CHANGE] Button

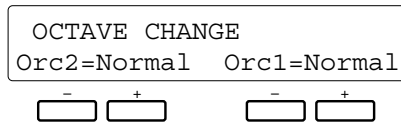

Select the OCTAVE CHANGE function from the normal play mode by pressing the [OCTAVE CHANGE] button (this is the same as the [▶] display scroll button to the right of the LCD panel).

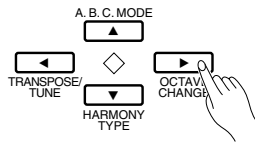

### 2 Set the Octave Change As Required

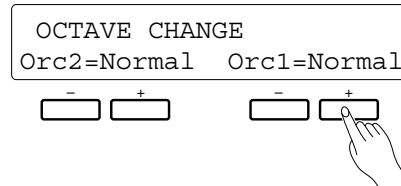

Use the left [-] and [+] buttons to set the octave of the ORCH. 2 voice, and the right [-] and [+] buttons to set the octave of the ORCH. 1 voice. "Normal" on the display indicates that the corresponding voice is set to its normal octave, "1down" indicates that the voice is shifted down one octave, and "1up" indicates that the voice is shifted up one octave.

### 3 Press [EXIT] When Done

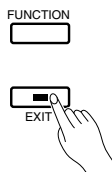

Press the [EXIT] button to exit from the OCTAVE CHANGE function.



*The OCTAVE CHANGE mode is automatically exited if neither of the [-] or [+] buttons are pressed for approximately 10 seconds.*



*Some voices may suddenly shift octaves when played at the extreme ends of the keyboard if they are set to a lower or higher octave than normal. This can also occur when the PITCH BEND wheel is used on extremely low or high notes.*



*If you change the transpose, octave change, or tuning settings while playing one or more notes on the keyboard, the new transpose and octave change settings will take effect from the next notes played while tune settings take effect immediately.*

# Voice Registration

If you have particular combinations of voices you like to use in the dual or split orchestration modes, the PSR-5700 lets you store up to 10 different combinations in its Voice Registration memory so that they can be recalled by pressing a single button. Voice registration also memorizes the volume settings of the voices; the orchestration; the ON/OFF status of the key velocity, sustain, and harmony effects; and the reverb and effect settings.

Here's how you can store and recall voice combinations:

## 1 Select the Desired Voices

```
>74:Aco. Bass
00: Eurobeat  52: Vibes
```

Select the desired ORCH. 1 and ORCH. 2 voices as described in the previous section. As an example, let's use the Acoustic Bass (number 74) and Vibes (number 52) voices.

## 2 Register the Combination in Memory

Press one of the VOICE SELECT NUMBER buttons ([0] through [9]) while holding the [MEMORY] button.

The diagram shows the control panel with the VOICE REGISTERATION button (top row, left) and the MEMORY button (bottom row, left) being pressed. The VOICE SELECT NUMBER buttons (0-9) are shown below. An arrow points from the panel to a display box containing the text: "Store Edited V.Regist -> 4".



If a voice registration was previously recalled, the corresponding voice registration number will appear in the upper right-hand area of the display.

## 3 Recall the Registered Combination

```
>00:Piano 1
00: Eurobeat  21: Strings1
```

Anytime you want to recall a registered voice combination, press the [VOICE REGISTERATION] button so that its indicator lights, then simply press the VOICE SELECT NUMBER button (lower row) corresponding to the desired combination. "V0" through "V9" will appear in the upper left corner of the display while a registered voice combination is selected.

The diagram shows the control panel with the VOICE REGISTERATION button (top row, left) being pressed, indicated by a starburst. The VOICE SELECT NUMBER button (4) (bottom row) is also being pressed. An arrow points from the panel to a display box containing the text: "V4 >74:Aco. Bass 00: Eurobeat 52: Vibes".

Press the [VOICE REGISTERATION] button so that its indicator goes out and its registration number disappears to return to the normal voice selection mode.



The "V?" symbol in the upper left corner of the display will disappear if any of the parameters listed below are changed.

### Data Stored By the Voice Registration Memory

- ORCHESTRA 1 VOICE
- ORCHESTRA 2 VOICE
- ORCHESTRA 1 VOLUME
- ORCHESTRA 2 VOLUME
- ORCHESTRA 1 OCTAVE
- ORCHESTRA 2 OCTAVE
- ORCHESTRATION
- HARMONY TYPE
- HARMONY ON/OFF
- SUSTAIN ORCH. 1/ORCH. 2 ON/OFF
- KEY VELOCITY ON/OFF
- PITCH BEND SELECT
- WHEEL ON/OFF (Modulation only)
- WHEEL TYPE
- REVERB ON/OFF
- REVERB TYPE & ORCH. 1/ORCH. 2 DEPTH
- EFFECT ON/OFF
- EFFECT TYPE & ORCH. 1/ORCH. 2 DEPTH
- SUSTAIN ON/OFF (when external SUSTAIN switch not connected)



Voice registration data can be saved to floppy disk. See page 46 of the Advanced Features manual for details.

# Using the Accompaniment Section

The PSR-5700 has 36 different accompaniment “styles” that can be used to provide fully-orchestrated or rhythm-only accompaniment. The PSR-5700’s sophisticated Auto Bass Chord accompaniment system can provide automated bass and chord backing that is perfectly matched to the selected accompaniment style.

## 1 Turn ABC ON

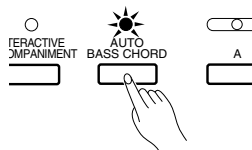

Press the [AUTO BASS CHORD] button so that its indicator lights, thereby turning the ABC mode on.



The maximum number of notes that can be played simultaneously on the PSR-5700 keyboard is reduced when the Auto Bass Chord feature is used.

## 2 Select the Desired ABC Mode

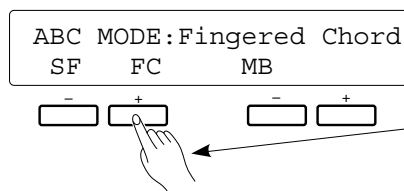

Press the [ABC MODE] button to select the ABC MODE display, then use the left [-] and [+] buttons to select the FINGERED CHORD or SINGLE FINGER mode, or the right [-] and [+] buttons to select the MANUAL BASS mode and specify the bass voice to be used. The ABC mode display ends automatically after about 10 seconds if the [-] and [+] buttons are not pressed.

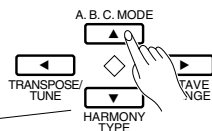

The FINGERED CHORD, SINGLE FINGER, and MANUAL BASS modes function as follows:

### ● FINGERED CHORD (FC):

This is the default ABC mode. The Fingered Chord mode lets you finger your own chords on the left-hand section of the keyboard (i.e. all keys to the left of and including the split-point key — normally F#2), while the PSR-5700 supplies appropriately orchestrated rhythm, bass, and chord accompaniment in the selected style.

The Fingered Chord mode will accept the chord types listed below (notes in parentheses may be omitted).

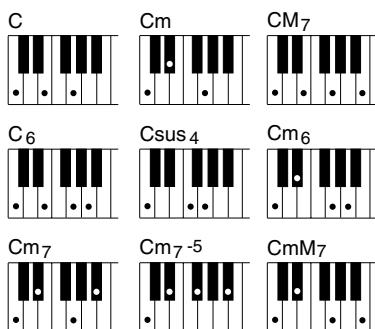

Chord Name/[Abbreviation]	Normal Voicing
Major [M]	1-3-5*
Minor [m]	1- $\flat$ 3-5*
Major seventh [M7]	1-3-(5)-7*
Major sixth [6]	1-3-5-6
Suspended fourth [sus4]	1-4-5*
Minor sixth [m6]	1- $\flat$ 3-5-6
Minor seventh [m7]	1- $\flat$ 3-(5)- $\flat$ 7
Minor seventh flatted fifth [m7-5]	1- $\flat$ 3- $\flat$ 5- $\flat$ 7
Minor major seventh [mM7]	1- $\flat$ 3-(5)-7*

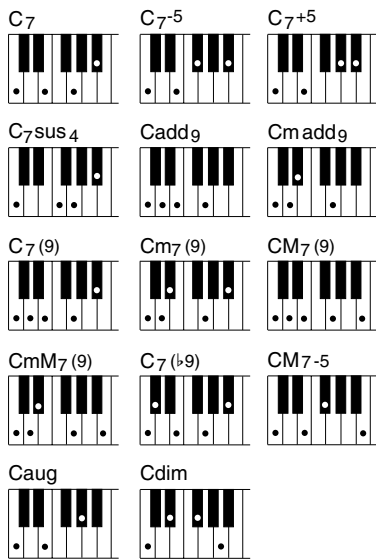

Seventh [7] .....	1-3-(5)-b7*
Seventh flattened fifth [7-5] .....	1-3-b5-b7
Augmented seventh [7+5] .....	1-3-#5-b7*
Seventh suspended fourth [7sus4] .....	1-4-5-b7*
Added ninth [add9] .....	1-2-3-5*
Minor added ninth [madd9] .....	1-2-b3-5*
Seventh ninth [7(9)] .....	1-2-3-(5)-b7*
Minor seventh ninth [m7(9)] .....	1-2-b3-(5)-b7*
Major seventh ninth [M7(9)] .....	1-2-3-(5)-7*
Minor major seventh ninth [mM7(9)] .....	1-2-b3-(5)-7*
Seventh flattened ninth [7(b9)] .....	1-b2-3-(5)-b7*
Major seventh flattened fifth [M7-5] .....	1-3-b5-7*
Augmented [aug] .....	1-3-#5
Diminished [dim] .....	1-b3-b5-(6)

\* Chords marked with an asterisk (\*) can be played in any inversion (i.e. the root of the chord does not have to be the lowest note played).

\* If you play any three adjacent keys (including black keys), the chord sound will be cancelled and only the rhythm instruments will continue playing (CHORD CANCEL function).

### ● SINGLE FINGER (SF):

Single-finger accompaniment makes it simple to produce beautifully orchestrated accompaniment using major, seventh, minor and minor-seventh chords by pressing a minimum number of keys on the left-hand section of the keyboard. The abbreviated chord fingerings described below are used:

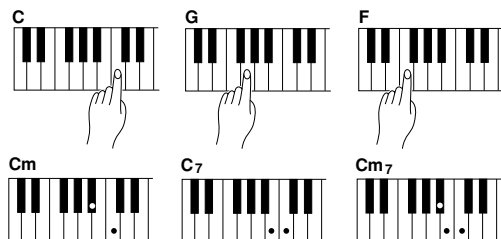

- For a major chord, press the root key only.
- For a minor chord, press the root key and a black key to its left.
- For a seventh chord, press the root key and a white key to its left.
- For a minor-seventh chord, press the root key and both a white and black key to its left.

### ● MANUAL BASS (MB):

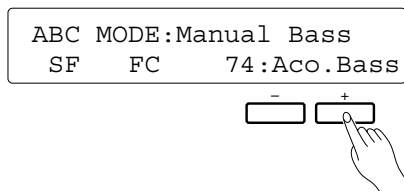

The Manual Bass mode provides an alternative to the normal split keyboard. The bass voice assigned to the left-hand keyboard section is monophonic, while a polyphonic ORCH. 1 voice is played on the upper section of the keyboard. You can select any of the PSR-5700's normal voices (00 through 89) to play on the lower section of the keyboard — of course, it's normal to choose a bass voices for the left hand. No automatic bass and chord accompaniment is produced, although the Interactive Accompaniment feature (page 24) does affect the rhythm sound.



Voices created using the PSR-5700 Custom Voice feature (Advanced Features manual, page 27) can also be selected for use with the Manual Bass mode.

# Using the Accompaniment Section

## 3 Select a Style

A list of the 36 accompaniment styles is printed on the PSR-5700 for easy reference.

### Style List

BANK 0		BANK 1		BANK 2		BANK 3		BANK 4		BANK 5	
00	EUROBEAT	10	8 BEAT BALLAD	20	SYNTH BOOGIE	30	JAZZ BALLAD	40	BOSSA NOVA	50	REGGAE
01	DANCE POP	11	ROCK SHUFFLE	21	SOUL ROCK	31	SHUFFLE	41	SAMBA	51	COUNTRY
02	PARTY POP	12	16 BEAT-LIGHT	22	SOUL BALLAD	32	BOOGIE	42	LATIN POP	52	POLKA
03	ROCK'N'ROLL	13	16 BEAT BALLAD	23	FUNK SHUFFLE	33	WALTZ	43	RHUMBA	53	MARCH
04	60'S ROCK	14	PIANO BALLAD	24	SWING	34	SLOW WALTZ	44	TANGO	54	6/8 MARCH
05	8 BEAT-LIGHT	15	6/8 SLOW ROCK	25	BIG BAND	35	JAZZ WALTZ	45	CHA-CHA	55	NEW AGE

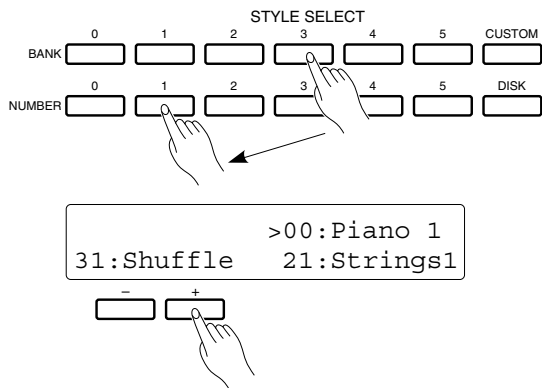

Use the STYLE SELECT buttons to enter the number of the desired style. Press a button in the upper row (BANK) to select the “BANK” or “tens” digit, and then a button in the lower row (NUMBER) to select the “ones” digit. For example, to select style number 31 (SHUFFLE), press the BANK [3] button and then the NUMBER [1] button. The selected style number and name is displayed at the lower left corner of the LCD panel.



*If a BANK button is pressed but then no NUMBER button is pressed for more than about 3 seconds, the BANK entry will automatically be cancelled.*

The number of the style can also be decreased (decremented) or increased (incremented) by using the [-] and [+] buttons immediately below the style name on the LCD panel. Press either button briefly to decrement or increment the style number by one, or hold the button for continuous decrementing or incrementing.

Although you can select the ORCH. 1 voice you intend to play on the right-hand section of the keyboard and the ORCH. 2 voice if you use the split mode, the PSR-5700 automatically determines the voices to be used for the accompaniment bass and chords according the accompaniment style you select.

## 4 Set the Tempo



When you select a different style while the accompaniment is not playing, the “default” tempo for that style is also selected, and the tempo is displayed on the TEMPO display in quarter-note beats per minute. If the accompaniment is playing, the same tempo is maintained even if you select a different style.

You can change the tempo to any value between 40 and 280 beats per minute, however, by using [-] and [+] TEMPO buttons below the display. This can be done either before the accompaniment is started or while it is playing. Press either button briefly to decrement or increment the tempo value by one, or hold the button for continuous decrementing or incrementing.



*The default tempo for the selected style can be recalled at any time by pressing both the [-] and [+] buttons simultaneously.*

## 5 Start the Accompaniment

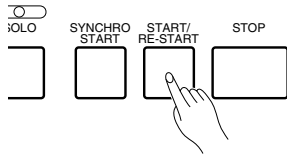

There are several ways to start the accompaniment:

- **Straight start:** Press the [START/RE-START] button. If you press the [START/RE-START] button, the rhythm will begin playing immediately without bass and chord accompaniment.



If you press the [START/RE-START] button while the accompaniment is playing, playback will immediately return to the first beat of the current accompaniment pattern, making it possible to create measures with odd time signatures.



It is also possible to select one of the several variations available prior to a straight start — refer to “7. Select Variations as Required,” below.

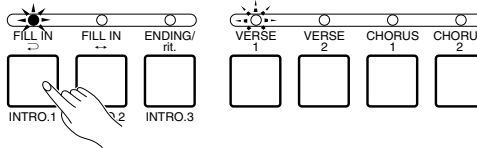

- **Start with an introduction followed by the VERSE 1 variation:** press the [INTRO. 1] button.

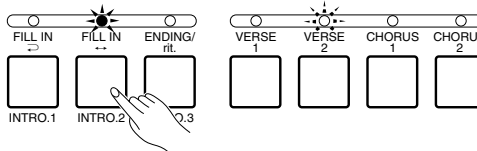

- **Start with an introduction followed by the VERSE 2 variation:** press the [INTRO. 2] button.

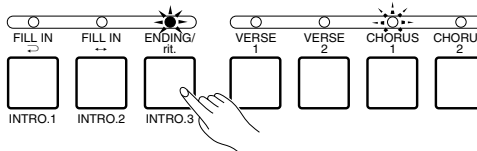

- **Start with an introduction followed by the CHORUS 1 variation:** press the [INTRO. 3] button.

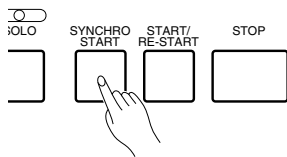

- **Synchronized start:** Any of the above start types can be synchronized to the first note or chord played on the left-hand section of the keyboard (i.e. keys to the left of and including the split-point key — normally F#2) by first pressing the [SYNCHRO START] button. Pressing the [SYNCHRO START] button alone causes a straight start to occur when the first note or chord is played. Press [SYNCHRO START] and then the appropriate INTRO button for a synchronized introduction start. The first dot of the BEAT display will flash at the current tempo when a synchronized start mode has been selected.



If you press the [SYNCHRO START] button while the accompaniment is playing, the accompaniment will stop and the synchro start mode will be engaged.

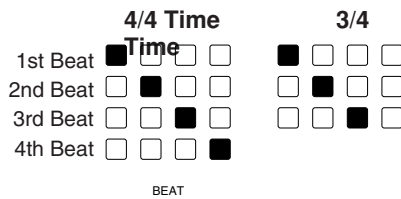

The four LED dots of the BEAT display provide a visual indication of the selected tempo as shown here:

Several LEDs will flash simultaneously on the first beat of odd-numbered measures in all time signatures.



A Yamaha FC5 footswitch plugged into the rear panel FOOT SW. jack can also be used to start the accompaniment if the appropriate function is assigned to the footswitch using the FOOT SWITCH SELECT function described on page 37 of the Advanced Features manual.

# Using the Accompaniment Section

## 6 Play On the Left-hand Section Of the Keyboard

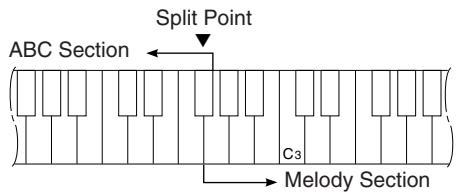

As soon as you play any chord that the PSR-5700 can “recognize” on the left-hand section of the keyboard in the FINGERED CHORD mode (see fingering chart on page 178) or an abbreviated chord in the SINGLE FINGER mode, the PSR-5700 will automatically begin to play the chord along with the selected rhythm and an appropriate bass line. The accompaniment will continue playing even if you release the left-hand keys.

If the MANUAL BASS mode is selected only the rhythm accompaniment will play automatically, and selected bass voice can be played on the left-hand section of the keyboard.



*The appropriate chord and bass note will sound if you play in the left-hand section of the keyboard while the ABC function is on but the accompaniment is stopped.*

## 7 Select Variations as Required

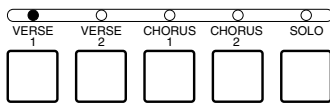

Each accompaniment style has a number of variations: INTRO, VERSE 1, VERSE 2, CHORUS 1, and CHORUS 2. The VERSE and CHORUS variations further have more complex SOLO variations. There is also an ENDING variation which is described in step 9. The INTRO variation can be used to start the accompaniment as described in the preceding step. The remaining variations — VERSE 1, VERSE 2, CHORUS 1, CHORUS 2, and the SOLO variations of these — can be selected manually by pressing the corresponding variation button. It is also possible to select the variation that will follow the INTRO by pressing the appropriate variation button while the INTRO is playing or while the intro synchro start mode is engaged.



*Some INTRO, ENDING, and SOLO variations have their own chord progressions which play in the current accompaniment key — the key is shown in the top left-hand corner of the LCD.*

### ● The SOLO Variations

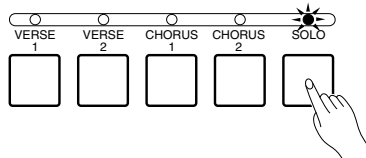

Although the SOLO variations can be selected manually, they can also be activated automatically when INTERACTIVE ACCOMPANIMENT is engaged (see page 24). If an accompaniment is playing and nothing is played on the keyboard for several measures, the SOLO mode is automatically engaged to “fill out” the accompaniment. When SOLO is on, not only are the variations more complex, but they will automatically cycle (VERSE 1 → VERSE 2 → CHORUS 1 → CHORUS 2 → VERSE 1, etc.). If the SOLO mode is on, it will be automatically disengaged after you begin playing on the keyboard.

This automatic switching of the solo mode can be turned off via the Auto Solo function described on page 40 of the Advanced Features manual.



*The SOLO variation will be automatically disengaged if it is turned on prior to starting the accompaniment with an introduction.*

## 8 Use Fill-ins

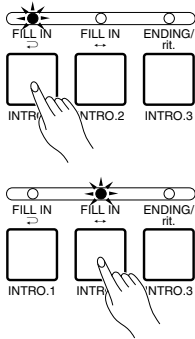

The PSR-5700 provides two types of automatic breaks or “fill-ins.”

- **FILL IN ↔**: Press the [FILL IN ↔] button to produce a short fill and return to the same variation.
- **FILL IN ↔**: Press the [FILL IN ↔] button to produce a fill and then go to the corresponding chorus or verse:
  - VERSE 1 ↔ CHORUS 1
  - VERSE 2 ↔ CHORUS 2

It is possible to change the variation that will play after the fill-in by pressing the appropriate variation button while the fill-in is playing. If you hold one of the FILL IN buttons, the fill-in will repeat until the button is released.



A Yamaha FC5 footswitch plugged into the rear panel FOOT SW. jack can also be used to activate fill-ins if the appropriate function is assigned to the footswitch using the FOOT SWITCH SELECT function described on page 37 of the Advanced Features manual.



The transitions between the verse and chorus are different when SOLO is ON.

## 9 Stop the Accompaniment

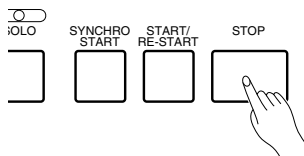

The accompaniment can be stopped at any time by pressing the [STOP] button. Press the [ENDING/rit.] button if you want to go to the ending variation and then stop. Press the [ENDING/rit.] button while the ending variation is playing to produce a “ritardando” ending — i.e. the tempo gradually slows down during the ending.



If ABC is turned on in the single or dual voice mode, a strings voice will sound on the left-hand section of the keyboard while the rhythm is stopped. Please note that left hold cannot be applied to this strings voice.

### ● Accompaniment Volume

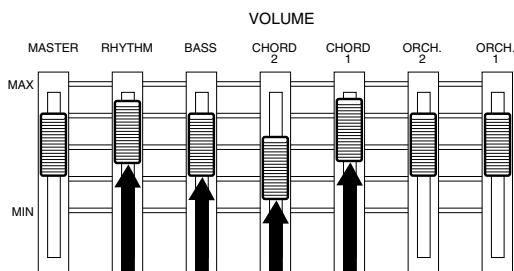

Use the [RHYTHM], [BASS], [CHORD 1], and [CHORD 2] VOLUME controls to set the best balance between the corresponding accompaniment parts, and the optimum volume of the accompaniment parts in relation to the ORCH. 1 and ORCH. 2 voices.

### ● Rhythm-only Accompaniment

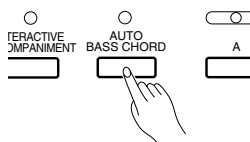

The AUTO BASS CHORD mode can be turned off at any time — leaving the rhythm accompaniment only — by pressing the [AUTO BASS CHORD] button so that its indicator goes out.



# Using the Accompaniment Section

## Interactive Accompaniment

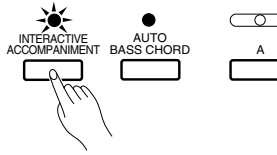

Press the [INTERACTIVE ACCOMPANIMENT] button so that its indicator lights to activate the Interactive Accompaniment mode. In this mode the PSR-5700 uses advanced technology to monitor the way you are playing on the keyboard and automatically varies the rhythm or ABC accompaniment accordingly.

If you are playing with the VERSE 1 variation, for example, and you begin to build up the musical excitement on the keyboard (i.e. play more notes, faster, and/or harder) the PSR-5700 will automatically switch to the VERSE 2 variation to better support what you are playing. On the other hand, if you play more mellow right-hand lines the PSR-5700 will automatically “shift down” to the VERSE 1 variation. The same applies to the CHORUS 1 and CHORUS 2 variations.



The “sensitivity” of the Interactive Accompaniment mode can be adjusted via the INTERACTIVE ACCOMPANIMENT Sensitivity function described on page 40 of the Advanced Features manual. Also note that automatic switching between VERSE 1 and VERSE 2 or CHORUS 1 and CHORUS 2 will not occur if INTERACTIVE ACCOMPANIMENT Mode 1 is selected — see page 40 of the Advanced Features manual.

## ■ Auto Solo

When the AUTO SOLO function is turned ON (ON is the default setting — see page 40 of the Advanced Features manual), the SOLO accompaniment variations will automatically be activated if nothing is played on the keyboard for a few measures. Further, the solo variations will automatically be de-activated from the end of the current phrase after keyboard performance is resumed.

### ABC/IA Accompaniment Flow Diagram

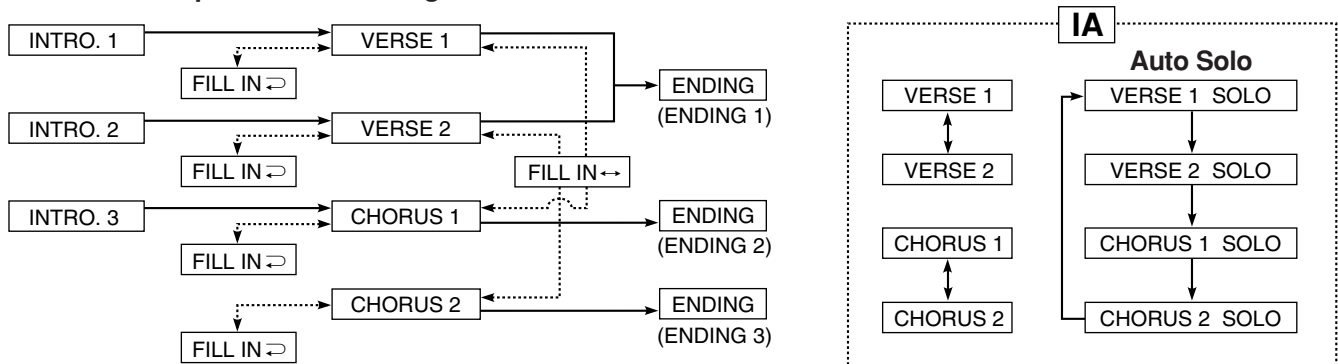

## Using the Disk Style on the Supplied Data Disk

### The Disk Style

The data disk supplied with the PSR-5700 contains 1 disk style that can be used in addition to the 36 70'S DISCO internal styles. Use the following procedure to assign the desired disk style to the [DISK] style button on the PSR-5700 panel.

### 1 Insert the Data Disk

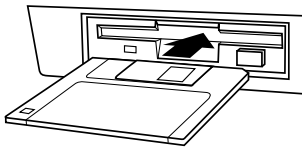

Insert the data disk into the PSR-5700 disk drive (located below the right end of the keyboard) with the disk shutter facing the drive slot and the label side facing upward.

### 2 Press [FROM DISK]

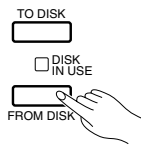

FROM DISK    Size: 50k  
00:SET1        NO YES

Press the [FROM DISK] button. The display shown to the left should appear.

### 3 Press the Right [+] Button

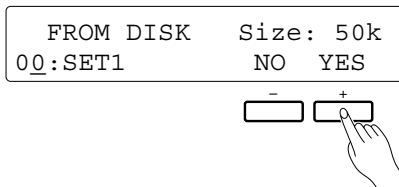

Press the right [+] button to begin loading. "Don't remove disk" will appear on the display while the data is loading. "Completed!" will appear briefly when the data has been successfully loaded, and the normal play mode will then be automatically engaged.

If you press the right [-] button instead of the [+], the load operation will be cancelled and the normal play mode will be engaged immediately.



*The data disk contains sequence and custom style data in addition to the disk style data. This data will be loaded as well as the disk style data when the above procedure is carried out. See "F5 DISK" on page 46 of the Advanced Features manual for instructions on how to load only the disk style data.*



*If an error message appears during the disk load procedure, refer to page 48 of the Advanced Features manual for details.*

### ● Selecting a DISK Style

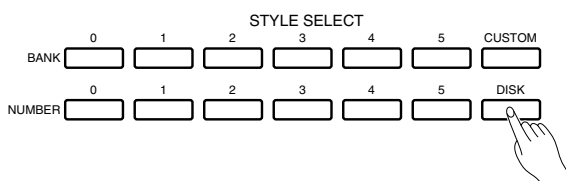

Once loaded, the disk style can be selected and used in the same way as the internal styles by pressing the [DISK] button.



*Disk style data that has been loaded into the PSR-5700 can be saved to a different floppy disk. See page 46 of the Advanced Features manual for details.*

# Super Style Play

The PSR-5700's 36 internal styles and the external disk style each have 4 different preset "panel setups" that can be instantly selected via the SUPER STYLE PLAY buttons — [VERSE A], [VERSE B], [CHORUS A], and [CHORUS B] — to create different musical textures. The SUPER STYLE PLAY setups include settings for all of the following parameters:

- ORCHESTRATION
- ORCHESTRA 1 VOICE
- ORCHESTRA 2 VOICE
- ORCHESTRA 1 VOLUME
- ORCHESTRA 2 VOLUME
- BASS VOLUME\*
- CHORD 1 VOLUME\*
- CHORD 2 VOLUME\*
- RHYTHM VOLUME\*
- ORCHESTRA 1 OCTAVE
- ORCHESTRA 2 OCTAVE
- HARMONY TYPE
- LEFT HOLD ON/OFF\*
- SUSTAIN ON/OFF
- SUSTAIN PART SELECT
- PITCH BEND SELECT
- REVERB ON/OFF
- REVERB TYPE & DEPTH
- EFFECT ON/OFF
- EFFECT TYPE & DEPTH

\* Parameters marked with an asterisk (\*) are not stored by the VOICE REGISTRATION function described on page 17. On the other hand, the WHEEL ON/OFF, WHEEL TYPE, and KEY VELOCITY ON/OFF parameters registered by the VOICE REGISTRATION function are not included in the SUPER STYLE PLAY setups.

\* Although voice registration only allows the reverb and effect depth for the orchestra 1 and orchestra 2 voices to be memorized, Super Style Play allows all depth settings to be memorized.

## 1 Engage Super Style Play

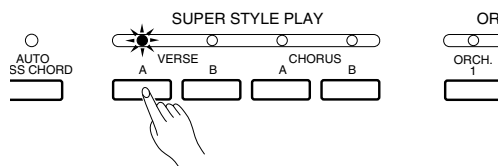

The SUPER STYLE PLAY feature can be used either while an accompaniment is playing or prior to starting an accompaniment by simply pressing the appropriate SUPER STYLE PLAY button so that its indicator lights: [VERSE A] for a soft, mellow feel; [VERSE B] for a slightly more active feel; [CHORUS A] for an even more lively sound; [CHORUS B] for maximum presence and animation.

If a different accompaniment style is selected while Super Style Play is engaged, the Super Style Play settings for that style will also be selected automatically.

## 2 Adjust The Settings If Necessary

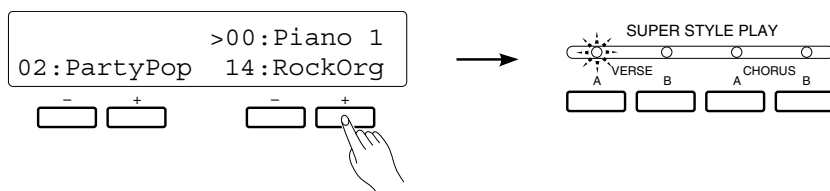

Any of the parameters set by the SUPER STYLE PLAY feature can be adjusted to create the desired sound after a SUPER STYLE PLAY setup has been selected. If you change a SUPER STYLE PLAY setting, the corresponding SUPER STYLE PLAY indicator will flash to indicate that a change has been made.

### 3 Memorize the Super Style Play Settings If You Like

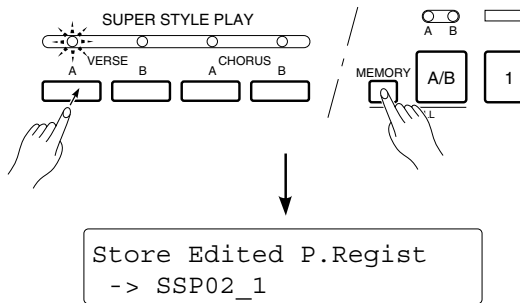

Your Super Style Play settings can be memorized by pressing the VERSE [A] or [B] or CHORUS [A] or [B] button while holding the Panel Registration [MEMORY] button.



The initial Super Style Play settings can be recalled by using the RECALL INITIAL DATA function described on page 50 of the Advanced Features manual.



Super Style Play settings can also be stored in the Panel Registration memory, and some settings can be saved in the Voice Registration memory.

### 4 Turn Super Style Play Off

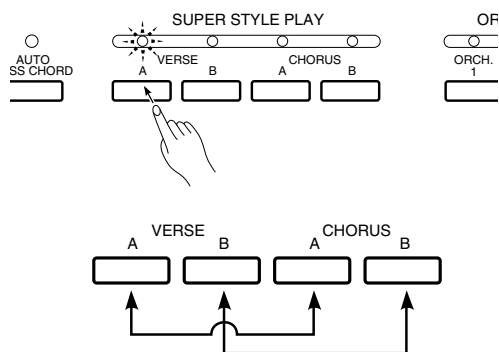

SUPER STYLE PLAY is turned OFF by pressing the currently engaged SUPER STYLE PLAY button a second time so that its indicator goes out. If the SUPER STYLE PLAY indicator is flashing because changes have been made to the panel settings, pressing any SUPER STYLE PLAY button twice turns SUPER STYLE PLAY off.



If you turn the SUPER STYLE PLAY Section Changing parameter described on page 41 of the Advanced features manual ON, the SUPER STYLE PLAY setup will automatically switch between VERSE A/B and CHORUS A/B, when the accompaniment variation switches between VERSE 1/2 and CHORUS 1/2.



SUPER STYLE PLAY cannot be used with accompaniment styles created using the Custom Accompaniment feature described on page 15 of the Advanced Features manual.



Super Style Play setup data can be saved to floppy disk. See page 46 of the Advanced Features manual for details.

# Using the Pads

The PSR-5700 features 8 “PADs” above the keyboard that can be used in a variety of ways:

- **MULTI:** When the MULTI mode is selected, the 4 pads marked “PHRASE” and the 4 pads marked “CHORD” can be used to record and play back short sequences of notes and chords, respectively.
- **PERC:** In the PERC mode the pads can be used to play 8 different drum and percussion instruments selected from the PSR-5700’s drum voices — 98 DRUM KIT and 99 POP DRUM KIT.
- **TEMPO:** In the TEMPO mode the pads are used to vary tempo in a number of ways, giving the PSR-5700 unprecedented capability for creative tempo variations while playing.

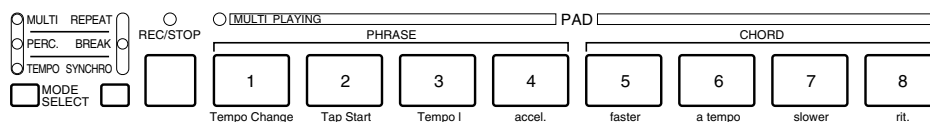

Pad data can be saved to floppy disk. See page 46 of the Advanced Features manual for details.

## The MULTI Mode

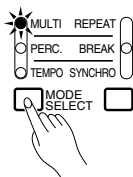

To engage the MULTI mode, press the [MODE SELECT] button a few times until the MULTI indicator lights.



Preset data is initially recorded in pads 1 through 8.

## The PHRASE Pads (pads 1 ... 4)

Each PHRASE pad can record up to approximately 160 notes played using the ORCH. 1 voice (only the ORCH. 1 voice is recorded even if the ORCH. 2+1 orchestration mode is selected). The recorded phrases can then be played back at any time — even while playing on the keyboard, with or without accompaniment. The PHRASE pads record the following data:

- VOICE NUMBER (ORCH. 1)
- NOTE ON/OFF (ORCH. 1)
- MODULATION (when MODULATION is ON for ORCHESTRA 1: see page 39 of the Advanced Features manual)
- ORCHESTRA 1 VOLUME
- SUSTAIN ON/OFF (when SUSTAIN is ON for ORCHESTRA 1: see page 38 of the Advanced Features manual)
- PITCH BEND (when PITCH BEND is ON for ORCHESTRA 1: see page 39 of the Advanced Features manual)
- GLIDE ON/OFF (when GLIDE is ON for ORCHESTRA 1: see page 37 of the Advanced Features manual)
- OCTAVE CHANGE (ORCH. 1)



The data listed above is also recorded if it is received via the PSR-5700 MIDI interface (Advanced Features manual, page 246).

## ■ Recording Phrases

### 1 Select a PHRASE Pad For Recording

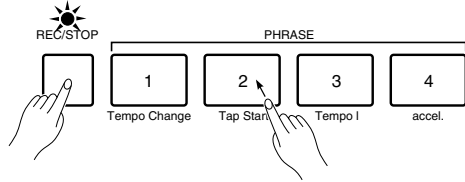

Press the PHRASE pad you intend to record to while holding the [REC/STOP] button. The REC/STOP indicator will flash, indicating that the selected pad is ready to record.

### 2 Play a Phrase

Recording begins automatically as soon as you play on the keyboard using the ORCHESTRA 1 voice (i.e. the right-hand section of the keyboard if the split play mode or AUTO BASS CHORD accompaniment is engaged), and the REC/STOP indicator will light continuously as long as recording continues.



*You can record phrases while AUTO BASS CHORD accompaniment is playing or stopped. In either case the phrase will be recorded in relation to the currently set accompaniment tempo, so it is a good idea to record phrases while monitoring the accompaniment to ensure that they are reproduced at an appropriate tempo when played back with accompaniment.*

### 3 Stop Recording

Press the [REC/STOP] button to stop recording when you've finished playing the phrase. The [REC/STOP] button indicator will go out when recording ends.



*Recording will stop automatically if the PHRASE pad memory becomes full (approximately 160 notes per pad), or if another pad is pressed.*

## ■ Phrase Playback

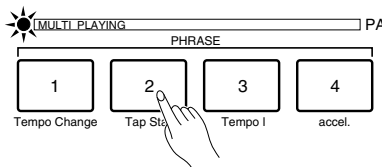

As long as the MULTI mode is selected, any recorded phrase can be played back simply by pressing the corresponding PHRASE pad. The phrase will play back whether the accompaniment is playing or not, but will always play at the currently set tempo. The MULTI PLAYING indicator will light while the phrase plays back, and playback will end automatically as soon as the end of the phrase is reached. A phrase can be stopped while it is playing by pressing either the [REC/STOP] button or the corresponding pad button. It is also possible to play back several phrases at the same time.



*Although the note data played by the phrase pads can not be recorded by the PSR-5700 sequencer (Advanced Features manual, page 3), the phrase pad events (i.e. the fact that a pad has been pressed) can be recorded. Phrase pad data can be saved to and loaded from disk (Advanced Features manual, page 46), but can not be memorized by the Panel Registration feature (page 38).*



*Use the MASTER VOLUME control to adjust the playback volume of the phrase pads.*

# Using the Pads

## The CHORD Pads (pads 5 ... 8)

Each CHORD pad can record up to approximately 80 chords played on the left-hand section of the keyboard when the AUTO BASS CHORD feature is engaged. The recorded chords can then be played back at any time — even while playing on the keyboard, with or without accompaniment.

### ■ Recording Chords

#### 1 Select a CHORD Pad For Recording

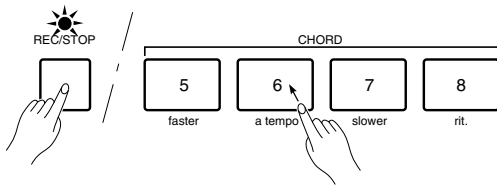

Press the CHORD pad you intend to record to while holding the [REC/STOP] button. The REC/STOP indicator will flash, indicating that the selected pad is ready to record. If the accompaniment is stopped when the CHORD pad is selected for recording, the SYNCHRO START mode will automatically be engaged.



*If AUTO BASS CHORD is OFF when a CHORD pad is selected for recording, it will automatically be turned ON. Further, if the MANUAL BASS mode is selected, the FINGERED CHORD mode will automatically be selected in its place.*

#### 2 Play the Required Chords

Recording begins automatically as soon as you play a chord on the left-hand section of the keyboard, and the REC/STOP indicator will light continuously as long as recording continues.

#### 3 Stop Recording

Press the [REC/STOP] button or the pad being recorded to stop recording when you've finished playing the chords. The [REC/STOP] button indicator will go out when recording ends.



*Recording will stop automatically if the CHORD pad memory becomes full (approximately 80 chords per pad); if another pad is pressed; or if the accompaniment [STOP], [START/RE-START], or [SYNCHRO START] buttons is pressed.*

### ■ Chord Playback

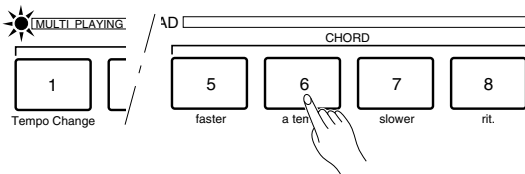

As long as the MULTI mode is selected and an AUTO BASS CHORD accompaniment is playing, any recorded chord sequence can be played back simply by pressing the corresponding CHORD pad. The phrase will play back at the currently set tempo. The MULTI PLAYING indicator will light while the chord sequence plays back, and playback will end automatically as soon as the end of the sequence is reached. Only one chord sequence can be played at a time.

During chord pad playback the ABC indicator will go out and the left-hand section of the keyboard plays in the same way as the right-hand section. To indicate that the end of the chord sequence is approaching, the MULTI PLAYING indicator flashes during the last two measures. A chord sequence that is playing can be stopped by pressing the same chord pad again, or by pressing the [REC/STOP] button.



If you press a CHORD pad while the accompaniment is stopped or while the AUTO BASS CHORD function is off, "Start ABC!" will appear on the display. Also, if AUTO BASS CHORD is on but the Manual Bass mode is selected, "Change to FC or SF mode!" will appear on the display, since chord playback will not function in the Manual Bass mode..



Chord pad playback can be recorded by the PSR-5700 sequencer.



Chord pad data can be saved to and loaded from disk (Advanced Features manual, page 46), but can not be memorized by the Panel Registration feature (page 38).



Playback occurs in measure units. Playback will continue until the end of the measure even if recording was stopped prior to the end of that measure.

## MULTI Pad Repeat Playback

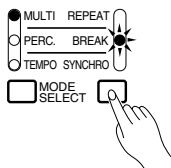

If you press the button immediately to the right of the pad [MODE SELECT] button so that the indicator above it lights while the MULTI mode is engaged, the MULTI REPEAT function is engaged and phrase or chord playback will repeat continuously until the [REC/STOP] button is pressed, the same pad is pressed a second time, or the REPEAT mode is turned off by pressing the button to the right of the [MODE SELECT] button again. In the last case the phrase or chord sequence will play through to the end and then stop.



## The PERC Mode

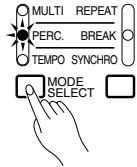

To engage the PERC mode, press the [MODE SELECT] button a few times until the PERC indicator lights.

The 8 pads are initially programmed with the following drum and percussion instruments which can be played via the pads when the PERC mode is selected:

1. Kick 1
2. Snare 3
3. Tom 1 Low
4. Tom 1 Mid
5. Tom 1 Hi
6. Closed Hi-Hat 1
7. Open Hi-Hat 1
8. Clash Cymbal 2

## Assigning Different Instruments To the PERC Pads

### 1 Press [REC/STOP]

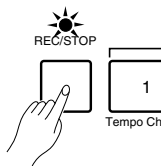

Press the [REC/STOP] button so that its indicator lights (make sure the PERC mode is selected first). You are now ready to assign new instruments to the pads.

### 2 Assign the Instruments

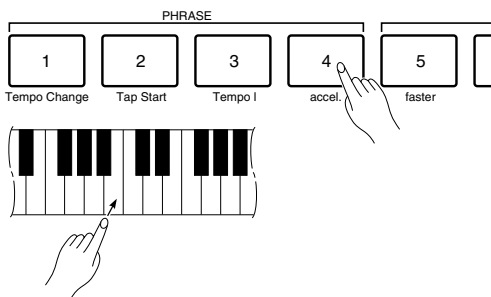

A new drum/percussion instrument is assigned to a pad simply by playing the key corresponding to the desired instrument while holding the drum pad to which it is to be assigned. The reverse also works: press the pad while holding the key. The velocity at which you play the key (how hard you press the key = how loud the note sounds) is also recorded to the specified pad.



*The DRUM KIT voice is automatically selected if you press the [REC/STOP] key while in the PERC mode and a non-drum voice is selected. You can select either voice 98 DRUM KIT or 99 POP DRUM KIT while still in the PERC assignment mode (simply press the NUMBER [8] or [9] button) to access different drum and percussion voices that you want to assign to the pads.*



*Percussion voices created using the CUSTOM VOICE EDIT functions described on page 27 of the Advanced Features manual cannot be assigned to the percussion pads.*

### 3 Press [REC/STOP] To End Assignment

When you're finished making instrument assignments to the PERC pads, press the [REC/STOP] button so that its indicator goes out.



*Percussion pad data can be saved to and loaded from disk (Advanced Features manual, page 45, 46), but can not be memorized by the Panel Registration feature (page 38).*

## Playing the Percussion Pads

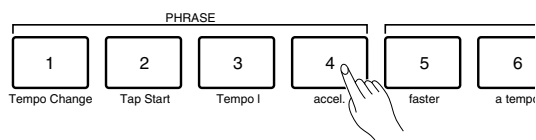

The PERC pads can be played at any time — whether an accompaniment is playing or not — as long as the PERC mode is selected. Depending on the assigned instrument, some pads will play continuously as long as they are held.



*The PERC pad sounds are not affected by the PSR-5700 PITCH BEND wheel or EFFECT settings.*

## The PERC BREAK Function

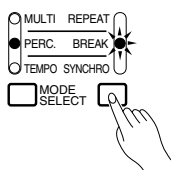

If you press the button immediately to the right of the pad [MODE SELECT] button so that the indicator above it lights while the PERC mode is engaged, the PERC BREAK function is engaged — playing on the PERC pads causes the accompaniment rhythm to stop playing so you can create your own fill-in. The accompaniment rhythm begins playing from the beginning of the next measure when you stop playing the percussion pads.

The BREAK mode is turned off by pressing the button to the right of the [MODE SELECT] button again.

## The TEMPO Mode

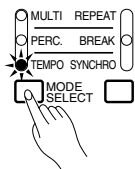

To engage the TEMPO mode, press the [MODE SELECT] button a few times until the TEMPO indicator lights.

The functions of the pads in the TEMPO mode are indicated by labels below each pad:

### ● Tempo Change

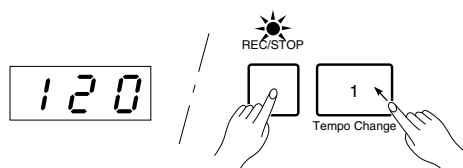

If you press this pad while holding the [REC/STOP] button, the tempo at that instant is registered in memory. The registered tempo can then be recalled at any time, regardless of the current tempo, simply by pressing the [Tempo Change] pad.



*If this pad is used during an accelerando or ritardando (described below), the accelerando or ritardando stops immediately and the [Tempo Change] value takes effect.*

### ● Tap Start



While the accompaniment is stopped, or during the SYNCHRO START mode before the accompaniment is started, the [Tap Start] pad can be used to set any desired tempo (within the PSR-5700's 40 to 280 beats per minute range) by simply tapping on the pad at the required tempo. Tap 4 times for an accompaniment with a 4/4 time signature, 3 times for 3/4, and 5 times for 5/4.



*If the accompaniment is started before the required number of taps has been entered, the Tap Start setting will be ignored. The Tap Start setting will also be ignored if several seconds elapse before the required number of taps have been entered, if a different style is selected, or if the accompaniment [STOP] button is pressed.*

### ● Tempo I (Tempo Primo)



If the [Tempo I] pad is tapped while an accompaniment is playing, the tempo setting that was active when the accompaniment was started is immediately restored, regardless of any tempo changes that occurred after the accompaniment was started.



*If this pad is used during an accelerando or ritardando (described below), the accelerando or ritardando stops immediately and the [Tempo I] value takes effect.*

### ● accel. (Accelerando)



Pressing the [accel.] pad immediately starts a 2-measure accelerando (tempo increase) that is executed by increasing the tempo by a small amount on every 8th beat. The accelerando is stopped if the [accel.] pad is pressed again before the 2 measures are completed.

## ● faster



Tap the [faster] pad to increase the tempo by a fixed amount, whether the accompaniment is playing or not.



*If this pad is used during an accelerando or ritardando, the accelerando or ritardando stops immediately and the [faster] value takes effect.*

## ● a tempo



This pad recalls the tempo prior to the last tempo change — e.g. any change incurred by pressing the [Tempo Change], [accel.], [faster], [slower], or [rit.] pad.



*If this pad is used during an accelerando or ritardando, the accelerando or ritardando stops immediately and the [a tempo] value takes effect.*

## ● slower



Tap the [slower] pad to decrease the tempo by a fixed amount, whether the accompaniment is playing or not.



*If this pad is used during an accelerando or ritardando, the accelerando or ritardando stops immediately and the [slower] value takes effect.*

## ● rit. (Ritardando)



Pressing the [rit.] pad immediately starts a 2-measure ritardando (tempo decrease) that is executed by decreasing the tempo by a small amount on every 8th beat. The ritardando is stopped if the [rit.] pad is pressed again before the 2 measures are completed.



*The [PAD 8/rit.] pad has essentially the same effect on the tempo as the [ENDING/rit.] pad (page 23), except that while the [ENDING/rit.] pad causes the tempo to return to its initial value after the rhythm stops, the tempo does not return to its initial value if the [PAD 8/rit.] pad is used, even after the rhythm is stopped.*



*If a fill-in pattern is selected during a ritardando, the ritardando continues during the fill-in but then original tempo is then restored as soon as the fill-in ends.*

## The TEMPO SYNCHRO Function

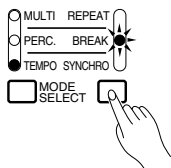

If you press the button immediately to the right of the pad [MODE SELECT] button so that the indicator above it lights while the TEMPO mode is engaged, the TEMPO SYNCHRO function is engaged — any tempo change initiated by a TEMPO pad takes place at the beginning of the next measure instead of immediately when the pad is tapped (TEMPO SYNCHRO has no effect on Tap Start operation).

The SYNCHRO mode is turned off by pressing the button to the right of the [MODE SELECT] button again.

## ■ Sustain

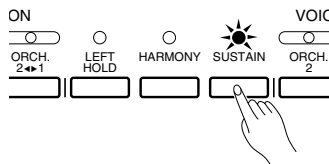

Press the [SUSTAIN] button to turn the sustain effect on or off. When on (indicator lit), extra sustain is applied to the selected voice. If a footswitch connected to the rear-panel SUSTAIN jack is pressed in order to apply sustain, however, the panel SUSTAIN function will be automatically turned off.



*Sustain can be applied to the ORCH. 1 voice only, the ORCH. 2 voice only, or both voices via the SUSTAIN ASSIGN function described on page 38 of the Advanced Features manual.*

## ■ Harmony

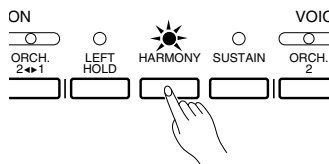

The harmony effect can only be used when the AUTO BASS CHORD accompaniment mode is selected. Press the [HARMONY] button to turn the HARMONY effect on or off. When HARMONY is on (indicator lit), playing single notes or chords\* on the right-hand section of the keyboard produces automatic harmony matched to the accompaniment chords. The type of harmony produced can be selected via the Harmony Type function described below.

\* The harmony is based on the top note of chords.



*Slight tempo delays may occur when harmony is used in conjunction with the ABC Fingered Chord mode.*

## ● Harmony Type Selection

### 1 Press the [HARMONY TYPE] Button

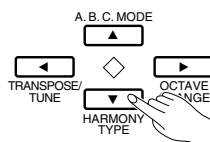
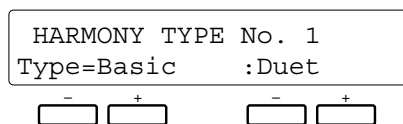

To select one of the 16 different harmony types available for the HARMONY function:

Select the HARMONY TYPE function from the normal play mode by pressing the [HARMONY TYPE] button (this is the same as the [▼] display scroll button to the right of the LCD panel).

### 2 Select a Harmony Type

The right [-] and [+] buttons step through the harmony list one by one. For faster selection you can use the left [-] and [+] buttons to directly select the harmony categories — Basic, Pop, etc. — and then use the right [-] and [+] buttons to select the desired harmony type within that category.

The HARMONY TYPE mode ends automatically if neither of the [-] or [+] buttons are pressed for approximately 10 seconds.

The Harmony Types are:

- |                  |                    |                      |                       |
|------------------|--------------------|----------------------|-----------------------|
| 1. Basic : Duet  | 4. Pop : Octaves   | 10. Jazz : 4WayClose | 15. Jazz : Guitar     |
| 2. Basic : Trio  | 5. Pop : PopRif.   | 11. Jazz : 4WayOpen  | 16. Classic : Strings |
| 3. Basic : 4Part | 6. Pop : Strings1  | 12. Jazz : VibesEns. |                       |
|                  | 7. Pop : Strings2  | 13. Jazz : SaxEns.   |                       |
|                  | 8. Pop : SynthEns. | 14. Jazz : WindEns.  |                       |
|                  | 9. Pop : AddVocal  |                      |                       |

## ■ Left Hold

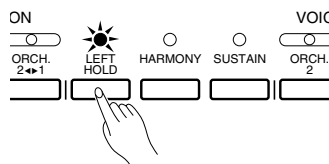

This function causes the left-hand (ORCH. 2) voice to be held even when the keys are released when using the AUTO BASS CHORD and Split modes. Non-decaying voices such as strings are held continuously, while decay-type voices such as piano decay more slowly (as if the sustain pedal has been pressed).



*The LEFT HOLD function works only while AUTO BASS CHORD accompaniment is running. Further, LEFT HOLD is temporarily disengaged during ENDING variations and INTRO or SOLO variations that have their own chord progressions.*



*LEFT HOLD will not function during Multi Pad playback or Sequencer ACCOMP. track playback even if the LEFT HOLD indicator is lit.*

## ■ Pitch Bend/Glissando Wheel

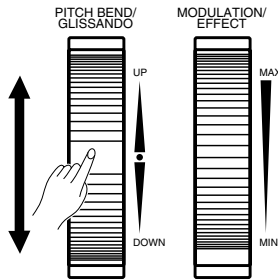

The PITCH BEND/GLISSANDO wheel to the left of the keyboard lets you bend the pitch of notes or “glissando” notes played on the keyboard up or down. Normal pitch is restored when the PITCH BEND/GLISSANDO wheel is released. The maximum pitch bend/glissando range is preset for each voice, but can be set as required for custom voices by using the CUSTOM VOICE EDIT feature described on page 27 of the Advanced Features manual.



*Pitch bend can be applied to the ORCH. 1 voice only, the ORCH. 2 voice only, or both voices via the PITCH BEND ASSIGN function described on page 39 of the Advanced Features manual. Also, pitch bend is applied to harmony notes on the basis of the ORCH. 1 settings.*



*The pitch bend wheel may have no effect when applied to notes at the upper and lower extremes of the keyboard if a CUSTOM VOICE is used. Also, sudden pitch changes may occur.*



*Pitch bend can be applied to notes from C-1 to C7 (i.e. MIDI note numbers 12 through 108). Pitch can not be bent down below the lowest note or up above the highest note in this range.*

## ■ Modulation/Effect Wheel

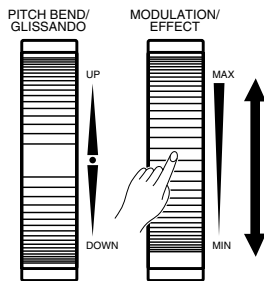

The MODULATION/EFFECT wheel to the left of the keyboard lets you apply effects or amplitude/pitch modulation to notes played on the keyboard. Rolling the MODULATION/EFFECT wheel upward (away from you) increases the effect or modulation depth. Use the WHEEL SELECT function described on page 39 of the Advanced Features manual to select effect or modulation operation. The type of effect applied when effect operation is selected is determined by the EFFECT TYPE function described on page 36 of the Advanced Features manual.

The modulation effect mode is preset for each voice, but can be set for custom voices by using the CUSTOM VOICE EDIT feature described on page 27 of the Advanced Features manual.



*Modulation is automatically applied to some voices, while to some it cannot be applied even if the modulation wheel is operated.*

## ■ Reverb

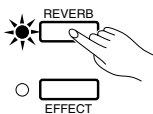

Press the [REVERB] button to apply the reverb effect specified by the REVERB TYPE function described on page 35 of the Advanced features manual to the ORCH. 1 and 2 voices as well as the chord and rhythm accompaniment sound. The [REVERB] button alternately turns the reverb effect on (indicator lit) or off (indicator out).

## ■ Effects

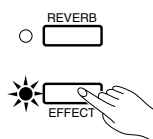

Press the EFFECT button to apply the effect specified by the EFFECT TYPE function described on page 36 of the Advanced features manual to the ORCH. 1 and 2 voices as well as the chord accompaniment sound. The [EFFECT] button alternately turns the effect on (indicator lit) or off (indicator out).

# Panel Registration

The PSR-5700 Panel Registration feature can be used to memorize 16 complete control-panel setups (2 banks, 8 setups each) that you can recall whenever needed.

INITIAL PANEL REGIST A1  
ROMANTIC PIANO



When the PSR-5700 is in its initial factory-preset condition, the panel registration memories contain preset setups. When these are recalled, a descriptive setup name will appear on the LCD for a few seconds (example: A1 ROMANTIC PIANO).

## ● Registering the Panel Settings

### 1 Set Up the Controls as Required

Make the desired control settings. The following settings are memorized by the Panel Registration function:

#### Data Stored By the Panel Registration Memory

- ORCHESTRA 1 VOICE
- ORCHESTRA 2 VOICE
- MANUAL BASS VOICE
- ORCHESTRA 1 VOLUME
- ORCHESTRA 2 VOLUME
- BASS VOLUME
- CHORD 1 VOLUME
- CHORD 2 VOLUME
- RHYTHM VOLUME
- ORCHESTRATION
- ORCHESTRA 1 OCTAVE
- ORCHESTRA 2 OCTAVE
- EFFECT ON/OFF
- EFFECT TYPE & DEPTH
- HARMONY ON/OFF
- HARMONY TYPE
- REVERB ON/OFF
- REVERB TYPE & DEPTH
- SUSTAIN ON/OFF (when external SUSTAIN switch not connected)
- SUSTAIN PART SELECT
- KEY VELOCITY ON/OFF
- STYLE
- AUTO BASS CHORD ON/OFF
- AUTO BASS CHORD MODE
- INTERACTIVE ACCOMPANIMENT ON/OFF
- INTERACTIVE ACCOMPANIMENT MODE 1/2
- INTERACTIVE ACCOMPANIMENT PART
- INTERACTIVE ACCOMPANIMENT SENSITIVITY
- AUTO SOLO ON/OFF
- SUPER STYLE PLAY
- MULTI PAD SELECT
- PAD SYNCHRO/BREAK/REPEAT ON/OFF
- TEMPO
- TRANSPOSE
- SPLIT POINT
- LEFT HOLD ON/OFF
- PITCH BEND SELECT
- WHEEL ON/OFF
- WHEEL TYPE
- ACCOMPANIMENT VARIATION
- FOOT SWITCH SELECT
- FOOT SWITCH PERCUSSION
- EXPRESSION PEDAL SELECT

### 2 Register in Memory

Use the [A/B] button to select memory bank A or B — the A or B indicator will light. Press and hold the MEMORY button, then press one of the PANEL REGISTRATION buttons. Any data that was previously in the selected location is erased and replaced by the new settings.

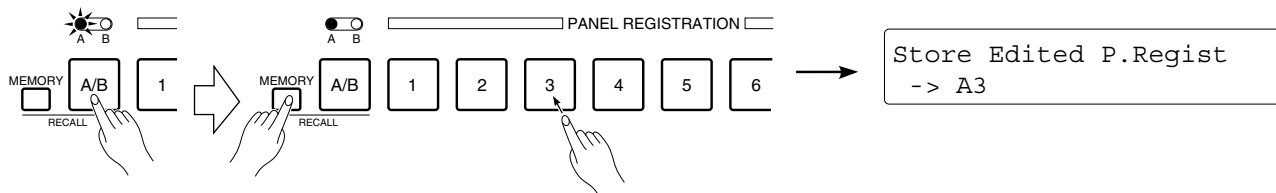

If a panel registration was previously recalled, the corresponding panel registration number will appear in the upper right-hand area of the display.

## ● Recall the Registered Panel Settings

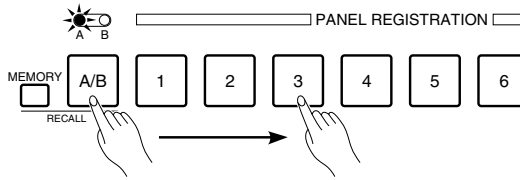

Simply select the appropriate bank using the [A/B] button and press the desired PANEL REGISTRATION button at any time to recall the memorized settings.



*No registration name is displayed when a user registration setup is recalled.*



*The preset registration setups can be recalled by using the initialization procedure described on page 50 of the Advanced Features manual.*

## ● Recall the Previous Panel Settings

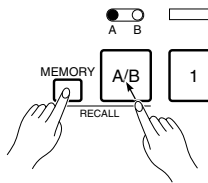

Press the [A/B] button while holding the [MEMORY] button to recall the panel settings prior to the last panel registration recall operation. This provides a handy way to compare different panel setups.



*Panel registration data can be saved to floppy disk. See page 46 of the Advanced Features manual for details.*



# Playing DOC (Disk Orchestra Collection) Disks

Using DISK ORCHESTRA disks (available from Yamaha), the PSR-5700 will let you enjoy listening to automated performances, or function as your “private music tutor,” allowing you to practice various parts of a piece while the others are played automatically.

- PSR-5700 supports General MIDI Level 1 as well as DOC.  
For more information, refer to page 50 of the Advanced Features manual.

## ● Automatic Performance

### 1 Insert the DOC Disk

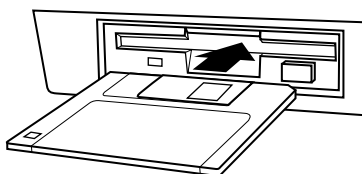

Insert the DISK ORCHESTRA disk into the PSR-5700 disk drive (located below the right end of the keyboard) with the metallic disk door facing the drive slot and the label side facing upward. The disk should click into place and the DISK IN USE lamp will light briefly while the PSR-5700 reads and identifies the disk.



To engage the DOC mode from another mode when the disk is already loaded in the drive, press the [DISK ORCHESTRA/GENERAL MIDI] button. Any rhythm or ABC operation in progress will stop automatically.



You can use the [EXIT] button or [DISK ORCHESTRA/GENERAL MIDI] button to exit from the DOC mode.

### 2 Select a Song Number

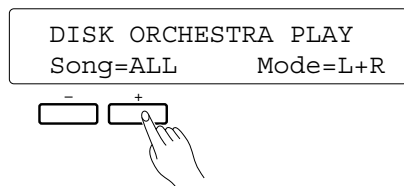

When the disk is inserted and identified the display shown to the left will appear (if this display doesn't appear, press the [DISK ORCHESTRA/GENERAL MIDI] button):

Use the [-] and [+] buttons below “Song=ALL” display to select the desired song number. Select “ALL” if you want all songs on the disk to be played and repeated until playback is stopped.

### 3 Press [START] To Begin Playback

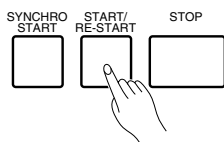

Start playback of the selected song by pressing the [START] button. Unless “ALL” is selected, the selected song will play through to the end and playback will stop automatically. The current measure number will normally be shown on the LCD display during playback.

Playback can be stopped at any time by pressing the [STOP] button.



Please note that playback cannot be started while the PSR-5700 is searching the disk for a selected song — this can take several seconds.



Some Disk Orchestra software does not produce a tempo display (e.g. free-tempo phrases, etc.). In this case, three lit bars appear along the center of the TEMPO display.

### 4 Eject the Disk When Done

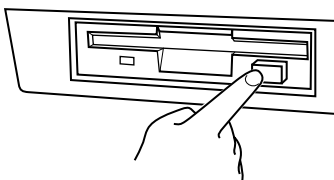

When you've finished with the currently loaded disk, simply press the disk drive EJECT button to remove it. This will automatically exit the DISK ORCHESTRA mode.



NEVER eject a disk or turn the power off while:  
1) the DISK ORCHESTRA function is playing.  
2) the DISK is formatting or recording.

## ● Playing Back only Specific Parts

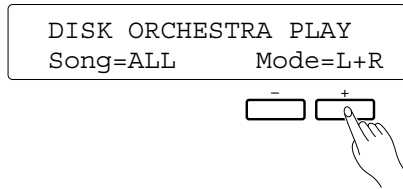

By turning off the left- or right-hand melody part, or both, you can practice playing those parts on the PSR-5700 keyboard. Sheet music is provided with the Disk Orchestra Collection disks.

Use the [-] and [+] buttons under “Mode=L+R” on the display to select the desired mode:

- **Mode=L+R:** Both the left- and right-hand parts are played automatically.
- **Mode=L:** Only the left-hand part is played automatically so you can practice the right-hand part.
- **Mode=R:** Only the right-hand part is played automatically so you can practice the left-hand part.
- **Mode=OFF:** Neither the left- or right-hand part is played, so you can practice playing both parts on the keyboard.



*The left and right-hand parts cannot be played separately on some songs.*



*The appropriate voice for the part you are going to play is automatically selected when you select a song (When “All” is selected, the voice for the first song is automatically selected).*

## ● Volume Control

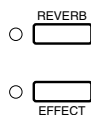
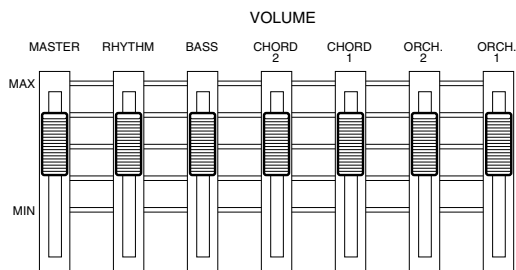

During DISK ORCHESTRA playback use the VOLUME controls to adjust the volume of the corresponding parts, as described below. As always, the MASTER control adjusts the overall volume level.

- ORCH.1:** Adjusts the volume of ORCH.1 played on the keyboard.
- CHORD1:** Adjusts the volume of the disk melody line.
- CHORD2:** Adjusts the volume of the disk backing.
- BASS:** Adjusts the volume of the disk bass part.
- RHYTHM:** Adjusts the volume of the disk rhythm part.



*Operation of the volume controls may be different with some songs. Further, the reverb or other effect can be turned on or off for all parts by using the REVERB or EFFECT button.*



*During DOC playback reverb (type) ON/OFF data may be read from the disk. When OFF data is received, the depth values for all parts other than the part you are playing are set to “0.” This means that unless you change the depth setting, reverb cannot be applied to those parts even if the REVERB indicator is lit. Also, since the effect depth values for all parts other than the part you will be playing are set to “0” before DOC playback is started, you will have to change the depth settings before effects can be applied to those parts, even if the EFFECT indicator is lit.*



*Since only the ORCH.1 voice is used for the part played on the keyboard in the DOC mode, the ORCH.2 volume control has no effect.*

# Troubleshooting

Symptom	Possible Cause	Solution
Noise is heard when the power is turned on or off.	This is a normal result of the power surge that occurs when the unit is turned on or off.	No solution necessary.
No sound.	The volume controls or expression pedal are turned all the way down.	Set the volume controls and expression pedal to a reasonable listening level.
	A pair of headphones is plugged into the HEADPHONES jack.	Unplug the headphones.
	MIDI local control is turned OFF.	Turn MIDI local control ON.
The ABC chord does not change even when a different chord is played.	You have attempted to play a new chord before fully releasing the previous chord in the left-hand section of the keyboard.	Be sure to release each chord completely before playing the next chord.
	You are using single-finger type fingering in the fingered mode, or vice-versa.	Use the correct type of chord fingering for the selected ABC mode.
The disk lamp lights dimly.	The PSR-5700 is constantly checking for the presence of a disk.	This is not a problem.

# Options

- Headphones ..... HPE-5/HPE-3
- Expression Pedal ..... EP-1
- Foot Switch ..... FC5
- Keyboard Stand ..... L-5

This index covers both the PSR-5700 “Getting Started” and “Advanced Features” manuals, so the page numbers include coded prefixes to indicate in which manual the information can be found:

GS = Getting Started  
AF = Advanced Features

- A**
- A tempo ..... GS-35
  - ABC ..... GS-18
  - Accelerando ..... GS-34
  - Accents ..... AF-16
  - Accompaniment ..... GS-18
  - Accompaniment name ..... AF-18, 20
  - Accompaniment style ..... AF-15
  - Accompaniment variation ..... AF-15
  - Attack ..... AF-29
  - Auto solo ..... GS-24
- B**
- Bank buttons ..... GS-13, 20
  - Bass & chord parts ..... AF-16
  - Beat display ..... GS-21
  - Brilliance ..... AF-30
- C**
- Change pattern ..... AF-23
  - Chord pads ..... GS-30
  - Chorus ..... GS-22
  - Cleaning ..... GS-4
  - Clock ..... AF-57
  - Common ..... AF-28
  - Condition/rec type ..... AF-7
  - Controller ..... AF-37
  - Copy ..... AF-22
  - Custom accompaniment edit ..... AF-19
  - Custom accompaniment programmer ..... AF-15
  - Custom number ..... AF-18
  - Custom voice edit ..... AF-27
  - Custom voice name ..... AF-27
- D**
- Data backup ..... GS-5
  - Data transmit ..... AF-58
  - Decay ..... AF-29
  - Delete all tracks ..... AF-11
  - Delete file ..... AF-47
  - Demo ..... GS-10
  - Disk ..... AF-42
  - Disk error messages ..... AF-48
  - Disk free area ..... AF-47
  - Disk functions ..... AF-45
  - Disk orchestra mode voice list ..... AF-253
  - Disk orchestra/general MIDI button ..... AF-50
  - Disk style ..... GS-25
  - DOC disk playback ..... GS-40
  - DOC mode ..... AF-52
  - DOC/GM mode ..... AF-50
  - Drum kits ..... GS-14
  - Drum voice edit ..... AF-33
  - Dual detune ..... AF-32
  - Dual mode ..... GS-12
  - Dual name ..... AF-30
  - Dual octave ..... AF-31
  - Dual pan ..... AF-32
  - Dual voice ..... AF-31
  - Dual voice edit ..... AF-30
  - Dual volume ..... AF-31
- E**
- Editing procedure ..... AF-26
  - Effect depth ..... AF-36
  - Effect type ..... AF-36
  - Effect wheel ..... GS-37
  - EG rate ..... AF-29
  - Electrical interference ..... GS-5
  - Erase ..... AF-12
  - Event abbreviations ..... AF-13
  - Exit button ..... AF-26
  - Exp. pedal select ..... AF-38
  - Expression & effects ..... GS-36
  - Expression pedal jack ..... GS-9

# Index

## F

Fader select .....	AF-20
Faster .....	GS-35
Fill-ins .....	GS-23
Fingered chords .....	GS-18
Fingering chart .....	GS-178
Floppy disks .....	GS-5, 25
Foot switch select .....	AF-37
Footswitch jack .....	GS-8
Format disk .....	AF-47
From disk .....	AF-45
From disk button .....	AF-44

## G

General function selection .....	AF-26
General MIDI .....	AF-51
General MIDI mode .....	AF-53
General MIDI mode voice list .....	AF-254
Glissando .....	GS-37
GM/DOC mode percussion map .....	AF-256

## H

Handling & transport .....	GS-4
Harmony .....	GS-36, AF-7
Headphones .....	GS-8
Hertz .....	GS-15

## I

Icons .....	GS-3
Initialization .....	GS-11
Input jacks .....	GS-8
Insert all tracks .....	AF-12
Interactive accompaniment .....	GS-24, AF-40
Intro, fill-in, ending patterns .....	AF-24
Introduction .....	GS-21

## K

Key velocity .....	AF-37
Keyboard percussion .....	GS-14

## L

Left hold .....	GS-36
Left-hand keyboard section .....	GS-22
Location .....	GS-4

## M

Manual bass .....	GS-19
Manuals, about the .....	GS-3
Measure/beat .....	AF-19
Memory backup .....	AF-49
Metronome .....	AF-7
MIDI .....	AF-49
MIDI bulk dump .....	AF-58
MIDI channel setting .....	AF-54
MIDI connectors .....	GS-9
MIDI function tree .....	AF-242
MIDI switch .....	AF-56
MIDI system .....	AF-57
Modulation .....	GS-37
Modulation depth .....	AF-28
Modulation speed .....	AF-28
Multi pad mode .....	GS-28
Multi pad repeat playback .....	GS-31
Multi part setting .....	AF-56
Music stand .....	GS-9

## N

Note shift .....	AF-14
Number buttons .....	GS-13, 20

## O

Octave .....	AF-28
Octave change .....	GS-16
Orchestra 1 and 2 .....	GS-13
Orchestration .....	GS-12
Output jacks .....	GS-8
Overdub recording .....	AF-8

## P

Pads .....	GS-28
Pan .....	AF-28
Panel registration .....	GS-38
Perc break function .....	GS-33
Perc pad mode .....	GS-32
Perc. name .....	AF-33
Perc. pan .....	AF-34
Perc. pitch .....	AF-33
Perc. tone .....	AF-34

- Percussion instrument cancel ..... AF-16
  - Percussion map ..... AF-255
  - Phrase pads ..... GS-28
  - Pitch bend ..... GS-37
  - Pitch bend range ..... AF-28
  - Pitch bend select ..... AF-39
  - Power supply ..... GS-4
  - Punch recording ..... AF-8
- Q**
- Quantize ..... AF-10, 21
- R**
- Recall initial data ..... AF-50
  - Record track selection ..... AF-4
  - Recordable parameters (sequencer) ..... AF-4
  - Recording type ..... AF-8
  - Release ..... AF-29
  - Remote control mode ..... AF-52
  - Remove event ..... AF-13, 23
  - Rename file ..... AF-46
  - Replace recording ..... AF-8
  - Resonance ..... AF-30
  - Reverb ..... GS-37
  - Reverb depth ..... AF-35
  - Reverb type ..... AF-35
  - Rhythm accompaniment ..... GS-23
  - Rhythm part ..... AF-15
  - Ritardando ..... GS-23, 35
- S**
- Save to accomp. .... AF-20
  - Sequence editing ..... AF-7
  - Sequencer playback ..... AF-6
  - Sequencer record ..... AF-3
  - Single-finger chords ..... GS-19
  - Slower ..... GS-35
  - Solo ..... GS-22
  - Song clear ..... AF-14
  - Song number ..... AF-3
  - Split mode ..... GS-12
  - Split point ..... AF-40
- Style list ..... GS-20
  - Super style play ..... GS-26
  - Super style play mode ..... AF-41
  - Sustain ..... AF-29, GS-36
  - Sustain jack ..... GS-9
  - Sustain part select ..... AF-38
  - Synchronized start ..... GS-21
- T**
- Tap start ..... GS-34
  - Tempo ..... GS-20
  - Tempo change ..... GS-34
  - Tempo I ..... GS-34
  - Tempo pad mode ..... GS-34
  - Tempo synchro function ..... GS-35
  - To disk ..... AF-46
  - To disk button ..... AF-42
  - Tone ..... AF-30
  - Touch sensitivity ..... AF-28
  - Track copy/mix ..... AF-9
  - Track delete ..... AF-5
  - Transposition ..... GS-15
  - Tuning ..... GS-15
- U**
- Utility ..... AF-49
- V**
- Variations ..... GS-22
  - Verse ..... GS-22
  - Voice list ..... GS-12
  - Voice registration ..... GS-17
  - Voice select buttons ..... GS-13
  - Voices, selecting ..... GS-11
  - Volume ..... AF-8, 19
  - Volume settings ..... GS-11, 13
- W**
- Wheel select ..... AF-39

# Fingering Chart/Akkordliste/Tablature/Gráfica de digitación

- Notes in parentheses ( ) can be omitted.
- Chord types marked with an asterisk (\*) can be played in inversion (i.e. the root does not have to be the lowest note in the chord).
- Please determine which chords you are going to use before playing a song. In the case of chords marked with a “●” it may be necessary to shift the split to allow easy fingering.

- Noten in Klammern ( ) können ausgelassen werden.
- Mit einem Sternchenzeichen (\*) versehene Akkorde können in jeder Umkehrung gespielt werden (d.h. der Grundton muß nicht die tiefste angeschlagene Note sein).
- Überlegen Sie sich bitte vor dem Spielen eines Stücks, welche Akkorde gebraucht werden. Bei Akkorden, die mit einem “●” gekennzeichnet sind, ist unter Umständen eine Verlagerung des Splitpunkts vorteilhaft, um das Greifen dieser Akkorde zu erleichtern.

## Major\* Dur\* Majeur\* Mayor\*

## Minor\* Moll\* Mineur\* Menor\*

## Major seventh\* Dur-Akkord mit großer Septime\* Septième majeure\* Séptima mayor\*

## Major sixth Dur-Akkord mit hinzugefügter Sexte Sixte majeure Sexta mayor

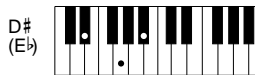
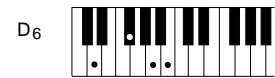
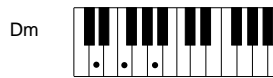
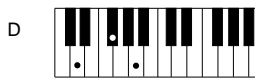
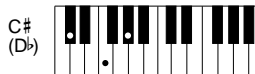

- Les notes entre parenthèses ( ) peuvent être omises.
- Les accords marqués d'un astérisque (\*) peuvent être joués dans n'importe quelle inversion (il n'est pas nécessaire que la note fondamentale de l'accord soit la note la plus basse).
- Veuillez déterminer quels accords que vous allez utiliser avant de commencer l'exécution d'un morceau. Dans le cas des accords marqués par "●", il peut s'avérer nécessaire de déplacer le point de partage pour faciliter l'exécution.

- Las notas entre paréntesis pueden omitirse.
- Los tipos de acorde marcados con un asterisco (\*) pueden tocarse en cualquier inversión (es decir, no es necesario que la raíz sea la nota más baja del acorde).
- Determine los acordes que desea utilizar antes de tocar una canción. En el caso de acordes marcados con "●", será necesario cambiar la división para facilitar el digitado.

**Suspended fourth\***  
**Dur-Akkord mit vorgehaltener Quarte\***  
**Quarte suspendue\***  
**Cuarta suspendida\***

**Minor sixth**  
**Moll-Akkord mit hinzugefügter Sexte**  
**Sixte mineure**  
**Sexta menor**

**Minor seventh**  
**Moll-Septakkord**  
**Septième mineure**  
**Séptima menor**

**Minor seventh flatted fifth**  
**Moll-Septakkord mit verminderter Quinte**  
**Quinte bémol septième mineure**  
**Menor de séptima quinta bemol**

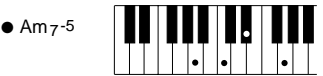
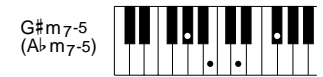



# Fingering Chart/Akkordliste/Tablature/Gráfica de digitación

**Minor major seventh\***  
**Moll mit großer Septime\***  
**Septième majeure mineure\***  
**Séptima mayor menor\***

**Seventh\***  
**Dur-Septakkord\***  
**Septième\***  
**Séptima\***

**Seventh flatted fifth**  
**Dur-Septakkord mit**  
**verminderter Quinte**  
**Quinte bémol septième**  
**Séptima quinta bemol**

**Augmented seventh\***  
**Dur-Septakkord mit**  
**übermäßiger Quinte\***  
**Septième augmentée\***  
**Séptima aumentada\***

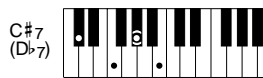

# Fingering Chart/Akkordliste/Tablature/Gráfica de digitación

**Seventh suspended fourth\***  
**Septakkord mit vorgehaltener Quarte\***  
**Quarte suspendue septième\***  
**Séptima cuarta suspendida\***

**Added ninth\***  
**Dur-Akkord mit hinzugefügter None\***  
**Neuvième ajoutée\***  
**Novena añadida\***

**Minor added ninth\***  
**Moll-Akkord mit hinzugefügter None\***  
**Neuvième ajoutée mineure\***  
**Menor de novena añadida\***

**Seventh ninth\***  
**Dur-Septakkord mit hinzugefügter None\***  
**Neuvième septième\***  
**Séptima novena\***

C<sub>7</sub>SUS<sub>4</sub>



Cadd<sub>9</sub>



Cm add<sub>9</sub>



C<sub>7</sub>(<sup>9</sup>)



C#<sub>7</sub>SUS<sub>4</sub>  
(D<sup>b</sup><sub>7</sub>SUS<sub>4</sub>)



C#add<sub>9</sub>  
(D<sup>b</sup>add<sub>9</sub>)



C#m add<sub>9</sub>  
(D<sup>b</sup>m add<sub>9</sub>)



C#<sub>7</sub>(<sup>9</sup>)  
(D<sup>b</sup><sub>7</sub>(<sup>9</sup>))



D<sub>7</sub>SUS<sub>4</sub>



Dadd<sub>9</sub>



Dm add<sub>9</sub>



D<sub>7</sub>(<sup>9</sup>)



D#<sub>7</sub>SUS<sub>4</sub>  
(E<sup>b</sup><sub>7</sub>SUS<sub>4</sub>)



D#add<sub>9</sub>  
(E<sup>b</sup>add<sub>9</sub>)



D#m add<sub>9</sub>  
(E<sup>b</sup>m add<sub>9</sub>)



D#<sub>7</sub>(<sup>9</sup>)  
(E<sup>b</sup><sub>7</sub>(<sup>9</sup>))



E<sub>7</sub>SUS<sub>4</sub>



Eadd<sub>9</sub>



Em add<sub>9</sub>



E<sub>7</sub>(<sup>9</sup>)



F<sub>7</sub>SUS<sub>4</sub>



Fadd<sub>9</sub>



Fm add<sub>9</sub>



F<sub>7</sub>(<sup>9</sup>)



F#<sub>7</sub>SUS<sub>4</sub>  
(G<sup>b</sup><sub>7</sub>SUS<sub>4</sub>)



F#add<sub>9</sub>  
(G<sup>b</sup>add<sub>9</sub>)



F#m add<sub>9</sub>  
(G<sup>b</sup>m add<sub>9</sub>)



F#<sub>7</sub>(<sup>9</sup>)  
(G<sup>b</sup><sub>7</sub>(<sup>9</sup>))



G<sub>7</sub>SUS<sub>4</sub>



Gadd<sub>9</sub>



Gm add<sub>9</sub>



G<sub>7</sub>(<sup>9</sup>)



G#<sub>7</sub>SUS<sub>4</sub>  
(A<sup>b</sup><sub>7</sub>SUS<sub>4</sub>)



G#add<sub>9</sub>  
(A<sup>b</sup>add<sub>9</sub>)



G#m add<sub>9</sub>  
(A<sup>b</sup>m add<sub>9</sub>)



G#<sub>7</sub>(<sup>9</sup>)  
(A<sup>b</sup><sub>7</sub>(<sup>9</sup>))



A<sub>7</sub>SUS<sub>4</sub>



Aadd<sub>9</sub>



Am add<sub>9</sub>



A<sub>7</sub>(<sup>9</sup>)



A#<sub>7</sub>SUS<sub>4</sub>  
(B<sup>b</sup><sub>7</sub>SUS<sub>4</sub>)



A#add<sub>9</sub>  
(B<sup>b</sup>add<sub>9</sub>)



A#add<sub>9</sub>  
(B<sup>b</sup>add<sub>9</sub>)



A#<sub>7</sub>(<sup>9</sup>)  
(B<sup>b</sup><sub>7</sub>(<sup>9</sup>))



B<sub>7</sub>SUS<sub>4</sub>



Badd<sub>9</sub>



Bm add<sub>9</sub>



B<sub>7</sub>(<sup>9</sup>)



# Fingering Chart/Akkordliste/Tablature/Gráfica de digitación

**Minor seventh ninth\***  
**Moll-Septakkord mit**  
**hinzugefügter None\***  
**Neuvième septième mineure\***  
**Manor de séptima novena\***

**Major seventh ninth\***  
**Dur-Akkord mit großer**  
**Septime und hinzugefügter**  
**None\***  
**Neuvième septième majeure\***  
**Mayor de séptima novena\***

**Minor major seventh**  
**ninth\***

**Moll-Akkord mit großer**  
**Septime und**  
**hinzugefügter None\***  
**Neuvième septième**  
**majeure mineure\***  
**Menor de séptima mayor**  
**novena\***

**Seventh flatted ninth\***  
**Dur-Septakkord mit**  
**verminderter None\***  
**Neuvième bémol**  
**septième\***  
**Séptima novena bemol\***



# Fingering Chart/Akkordliste/Tablature/Gráfica de digitación

**Major seventh flatted fifth\***  
**Dur-Akkord mit großer Septime und verminderter Quinte\***  
**Quinte bémol septième majeure\***  
**Mayor de séptima quinta bemol\***

**Augmented**  
**Übermäßig**  
**Augmenté**  
**Aumentada**

**Diminished**  
**Vermindert**  
**Diminué**  
**Disminuida**

CM <sub>7-5</sub>		Caug		Cdim	
C#M <sub>7-5</sub> (D <sup>b</sup> M <sub>7-5</sub> )		C#aug (D <sup>b</sup> aug)		C#dim (D <sup>b</sup> dim)	
DM <sub>7-5</sub>		Daug		Ddim	
D#M <sub>7-5</sub> (E <sup>b</sup> M <sub>7-5</sub> )		D#aug (E <sup>b</sup> aug)		D#dim (E <sup>b</sup> dim)	
EM <sub>7-5</sub>		Eaug		Edim	
FM <sub>7-5</sub>		Faug		Fdim	
F#M <sub>7-5</sub> (G <sup>b</sup> M <sub>7-5</sub> )		F#aug (G <sup>b</sup> aug)		F#dim (G <sup>b</sup> dim)	
GM <sub>7-5</sub>		Gaug		Gdim	
G#M <sub>7-5</sub> (A <sup>b</sup> M <sub>7-5</sub> )		G#aug (A <sup>b</sup> aug)		G#dim (A <sup>b</sup> dim)	
AM <sub>7-5</sub>		Aaug		Adim	
A#M <sub>7-5</sub> (B <sup>b</sup> M <sub>7-5</sub> )		A#aug (B <sup>b</sup> aug)		A#dim (B <sup>b</sup> dim)	
BM <sub>7-5</sub>		• Baug		Bdim	

# IMPORTANT SAFETY INSTRUCTIONS

## INFORMATION RELATING TO PERSONAL INJURY, ELECTRICAL SHOCK, AND FIRE HAZARD POSSIBILITIES HAS BEEN INCLUDED IN THIS LIST.

**WARNING-** When using any electrical or electronic product, basic precautions should always be followed. These precautions include, but are not limited to, the following:

- 1.** Read all Safety Instructions, Installation Instructions, Special Message Section items, and any Assembly Instructions found in this manual **BEFORE** marking any connections, including connection to the main supply.
- 2.** **Main Power Supply Verification:** Yamaha products are manufactured specifically for the supply voltage in the area where they are to be sold. If you should move, or if any doubt exists about the supply voltage in your area, please contact your dealer for supply voltage verification and (if applicable) instructions. The required supply voltage is printed on the name plate. For name plate location, please refer to the graphic found in the Special Message Section of this manual.
- 3.** This product may be equipped with a polarized plug (one blade wider than the other). If you are unable to insert the plug into the outlet, turn the plug over and try again. If the problem persists, contact an electrician to have the obsolete outlet replaced. Do **NOT** defeat the safety purpose of the plug.
- 4.** Some electronic products utilize external power supplies or adapters. Do **NOT** connect this type of product to any power supply or adapter other than one described in the owners manual, on the name plate, or specifically recommended by Yamaha.
- 5.** **WARNING:** Do not place this product or any other objects on the power cord or place it in a position where anyone could walk on, trip over, or roll anything over power or connecting cords of any kind. The use of an extension cord is not recommended! If you must use an extension cord, the minimum wire size for a 25' cord (or less) is 18 AWG. **NOTE:** The smaller the AWG number, the larger the current handling capacity. For longer extension cords, consult a local electrician.
- 6.** **Ventilation:** Electronic products, unless specifically designed for enclosed installations, should be placed in locations that do not interfere with proper ventilation. If instructions for enclosed installations are not provided, it must be assumed that unobstructed ventilation is required.
- 7.** **Temperature considerations:** Electronic products should be installed in locations that do not significantly contribute to their operating temperature. Placement of this product close to heat sources such as; radiators, heat registers and other devices that produce heat should be avoided.
- 8.** This product was **NOT** designed for use in wet/damp locations and should not be used near water or exposed to rain. Examples of wet/damp locations are; near a swimming pool, spa, tub, sink, or wet basement.
- 9.** This product should be used only with the components supplied or; a cart, rack, or stand that is recommended by the manufacturer. If a cart, rack, or stand is used, please observe all safety markings and instructions that accompany the accessory product.
- 10.** The power supply cord (plug) should be disconnected from the outlet when electronic products are to be left unused for extended periods of time. Cords should also be disconnected when there is a high probability of lightning and/or electrical storm activity.
- 11.** Care should be taken that objects do not fall and liquids are not spilled into the enclosure through any openings that may exist.
- 12.** Electrical/electronic products should be serviced by a qualified service person when:
  - a. The power supply cord has been damaged; or
  - b. Objects have fallen, been inserted, or liquids have been spilled into the enclosure through openings; or
  - c. The product has been exposed to rain; or
  - d. The product does not operate, exhibits a marked change in performance; or
  - e. The product has been dropped, or the enclosure of the product has been damaged.
- 13.** Do not attempt to service this product beyond that described in the user-maintenance instructions. All other servicing should be referred to qualified service personnel.
- 14.** This product, either alone or in combination with an amplifier and headphones or speaker/s, may be capable of producing sound levels that could cause permanent hearing loss. **DO NOT** operate for a long period of time at a high volume level or at a level that is uncomfortable. If you experience any hearing loss or ringing in the ears, you should consult an audiologist.  
**IMPORTANT:** The louder the sound, the shorter the time period before damage occurs.
- 15.** Some Yamaha products may have benches and/or accessory mounting fixtures that are either supplied as a part of the product or as optional accessories. Some of these items are designed to be dealer assembled or installed. Please make sure that benches are stable and any optional fixtures (where applicable) are well secured **BEFORE** using. Benches supplied by Yamaha are designed for seating only. No other uses are recommended.

## PLEASE KEEP THIS MANUAL

## FCC INFORMATION (U.S.A.)

**1. IMPORTANT NOTICE: DO NOT MODIFY THIS UNIT!**

This product, when installed as indicated in the instructions contained in this manual, meets FCC requirements. Modifications not expressly approved by Yamaha may void your authority, granted by the FCC, to use the product.

**2. IMPORTANT :** When connecting this product to accessories and/or another product use only high quality shielded cables. Cable/s supplied with this product **MUST** be used. Follow all installation instructions. Failure to follow instructions could void your FCC authorization to use this product in the USA.

**3. NOTE:** This product has been tested and found to comply with the requirements listed in FCC Regulations, Part 15 for Class "B" digital devices. Compliance with these requirements provides a reasonable level of assurance that your use of this product in a residential environment will not result in harmful interference with other electronic devices. This equipment generates/uses radio frequencies and, if not installed and used according to the instructions found in the users manual, may cause interference harmful to the operation of other electronic devices. Compliance with FCC regulations does not guarantee that interference will not occur in all installations. If this product is found to be the source of interference, which can be determined by turning the unit "OFF" and "ON", please try to eliminate the problem by using one of the following measures:

Relocate either this product or the device that is being affected by the interference.

Utilize power outlets that are on different branch (circuit breaker or fuse) circuits or install AC line filter/s.

In the case of radio or TV interference, relocate/reorient the antenna. If the antenna lead-in is 300 ohm ribbon lead, change the lead-in to co-axial type cable.

If these corrective measures do not produce satisfactory results, please contact the local retailer authorized to distribute this type of product. If you can not locate the appropriate retailer, please contact Yamaha Corporation of America, Electronic Service Division, 6600 Orangethorpe Ave, Buena Park, CA90620

The above statements apply **ONLY** to those products distributed by Yamaha Corporation of America or its subsidiaries.

Wichtiger Hinweis für die Benutzung in der Bundesrepublik Deutschland.

### Bescheinigung des Importeurs

Hiermit wird bescheinigt, daß der/die/das  
*Portable Keyboard Typ: PSR-5700*

(Gerät, Typ, Bezeichnung)

in Übereinstimmung mit den Bestimmungen der  
VERFÜGUNG 1046/84

(Amtsblattverfügung)

funk-entstört ist.

Der Deutschen Bundespost wurde das Inverkehrbringen dieses Gerätes angezeigt und die Berechtigung zur Überprüfung der Serie auf Einhaltung der Bestimmungen eingeräumt.

Yamaha Europa GmbH

Name des Importeurs

## IMPORTANT NOTICE FOR THE UNITED KINGDOM

### Connecting the Plug and Cord

IMPORTANT. The wires in this mains lead are coloured in accordance with the following code:

BLUE : NEUTRAL  
BROWN : LIVE

As the colours of the wires in the mains lead of this apparatus may not correspond with the coloured markings identifying the terminals in your plug proceed as follows:

The wire which is coloured BLUE must be connected to the terminal which is marked with the letter N or coloured BLACK.

The wire which is coloured BROWN must be connected to the terminal which is marked with the letter L or coloured RED.

Making sure that neither core is connected to the earth terminal of the three pin plug.

- This applies only to products distributed by Yamaha Europa GmbH.
- Dies bezieht sich nur auf die von der Yamaha Europa GmbH vertriebenen Produkte.
- Ceci ne s'applique qu'aux produits distribués par Yamaha Europa GmbH.
- Esto se aplica solamente a productos distribuidos por Yamaha Europa GmbH.

- This applies only to products distributed by Yamaha-Kemble Music (U.K.) Ltd.

## CANADA

THIS DIGITAL APPARATUS DOES NOT EXCEED THE "CLASS B" LIMITS FOR RADIO NOISE EMISSIONS FROM DIGITAL APPARATUS SET OUT IN THE RADIO INTERFERENCE REGULATION OF THE CANADIAN DEPARTMENT OF COMMUNICATIONS.

LE PRESENT APPAREIL NUMERIQUE N'EMET PAS DE BRUITS RADIOELECTRIQUES DEPASSANT LES LIMITES APPLICABLES AUX APPAREILS NUMERIQUES DE LA "CLASSE B" PRESCRITES DANS LE REGLEMENT SUR LE BROUILLAGE RADIOELECTRIQUE EDICTE PAR LE MINISTERE DES COMMUNICATIONS DU CANADA.

**CAUTION:** TO PREVENT ELECTRIC SHOCK, MATCH WIDE BLADE OF PLUG TO WIDE SLOT, FULLY INSERT.

**ATTENTION:** POUR ÉVITER LES CHOCS ÉLECTRIQUES, INTRODUIRE LA LAME LA PLUS LARGE DE LA FICHE DANS LA BORNE CORRESPONDANTE DE LA PRISE ET POUSSER JUSQU'AU FOND.

Dette apparat overholder det gældende EF-direktiv vedrørende radiostøj.

Cet appareil est conforme aux prescriptions de la directive communautaire 87/308/CEE.

Diese Geräte entsprechen der EG-Richtlinie 82/499/EWG und/oder 87/308/EWG.

This product complies with the radio frequency interference requirements of the Council Directive 82/499/EEC and/or 87/308/EEC.

Questo apparecchio è conforme al D.M.13 aprile 1989 (Direttiva CEE/87/308) sulla soppressione dei radiodisturbi.

Este producto está de acuerdo con los requisitos sobre interferencias de radio frecuencia fijados por el Consejo Directivo 87/308/CEE.

**YAMAHA CORPORATION**

- This applies only to products distributed by Yamaha Canada Music Ltd.
- Dies bezieht sich nur auf die von der Yamaha Canada Music Ltd. vertriebenen Produkte.
- Ceci ne s'applique qu'aux produits distribués par Yamaha Canada Music Ltd.
- Esto se aplica solamente a productos distribuidos por Yamaha Canada Music Ltd.



**YAMAHA**