



HS SERIES

POWERED STUDIO MONITOR

HS4 HS3

Owner's Manual

POWERED SPEAKER SYSTEM



Contents

Introduction.....	3
About this manual	3
NOTICE	4
Included Items	5
Cables	5
Setting Up for Superior Sound	7
Controls and Connectors.....	8
Rear	8
Front.....	10
Connections	11
Connecting the speakers with the included cable	11
Connecting to an Audio Interface	12
Connecting to a Mixer.....	13
Connecting to a Synthesizer or Other Electronic Musical Instrument.....	14
Connecting to a computer.....	15
Connecting to a smartphone	16
Connecting headphones.....	17
Turning on the power and making sound	18
Troubleshooting	20
Specifications.....	21
Dimensions	22
Frequency Response	23
Block Diagram	24

Introduction

Thank you for purchasing this Yamaha product. The HS4 and HS3 are compact, high-quality studio monitors that are designed for use in music and video production.

About this manual

How the manuals are organized

The manuals that cover the HS4 and HS3 are listed below.

- **Safety Guide (included with this product)**

Lists the safety-related points you need to be aware of when using this product. Be sure to read through this information before using the product, so that you use this product correctly and safely.

- **Quick Start Guide (included with this product)**

Explains the steps from setting up this product through playing sound, with illustrations.

- **Owner's Manual (this guide)**

Explains all functions of this product. Refer to this manual if there is something about the installation or operations in the Quick Start Guide that you didn't understand.

The precautions and related points in this manual are categorized as follows.



WARNING

This content indicates "risk of serious injury or death."



CAUTION

This content indicates "risk of injury."

NOTICE

Matters that must be observed to avoid product breakdown, damage or malfunction, as well as to prevent the loss of data and to protect the environment.

NOTE

Points of note when using this product, limitations in functionality, and supplementary information that's useful to know.

Keep the manuals included with this product in a place where you can refer to them whenever needed. You can also download these manuals from the Yamaha website, so please make use of these resources as necessary. <https://download.yamaha.com/>

NOTICE

To avoid the possibility of malfunction/damage to the product or damage to other property, follow the notices below.

■ Handling and maintenance

- **Do not obstruct the hole (bass reflex port) on the back of the speaker unit.**
This reduces the quality of the sound.
- **Do not use the product in the vicinity of a TV, radio, or other electric products.**
Otherwise, the product, TV, or radio may generate noise.
- **Do not expose the product to excessive dust or vibration, or extreme cold or heat, in order to prevent the possibility of unstable operation or damage to the internal components.**
- **Do not install in locations where temperature changes are severe.**
Otherwise, condensation may form on the inside or the surface of the product, causing it to break or deform the wood. Do not leave condensation on the wood; wipe immediately with a soft cloth.
- **If there is reason to believe that condensation might have occurred on the inside, leave the product for several hours without turning on the power until the condensation has completely dried out, in order to prevent possible damage.**
- **Do not touch the speaker driver unit, since it might cause malfunction.**
- **Do not place vinyl, plastic or rubber objects on the product, since this might cause alteration or discoloration.**
- **Clean the product with a dry and soft cloth. Do not use a chemically infused wiping cloth, chemical products or the like to clean this product,**
as these may cause discoloration or deterioration.

Information

■ About functions bundled with the product

XLR-type connectors are wired as follows (IEC60268 standard):

pin 1: ground, pin 2: hot (+), and pin 3: cold (-).

■ About the manuals

The illustrations in the Owner's Manual (this document), the Safety Guide and the Quick Start Guide are used for explanation.

The company names and product names in the Owner's Manual (this document), the Safety Guide and the Quick Start Guide are the trademarks or registered trademarks of their respective companies.

iPhone and Lightning are trademarks of Apple Inc. registered in the United States and other countries.

Android is a trademark of Google LLC.

Included Items

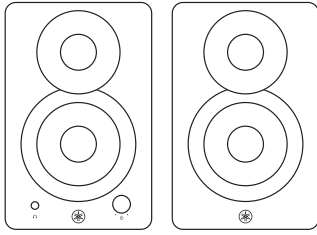

Speaker L x1, R x1

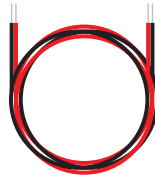

Speaker Cable x1

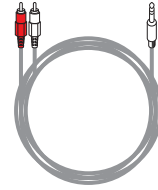

Stereo Mini-to-RCA Cable x1



Quick Start Guide x1



Safety Guide x1

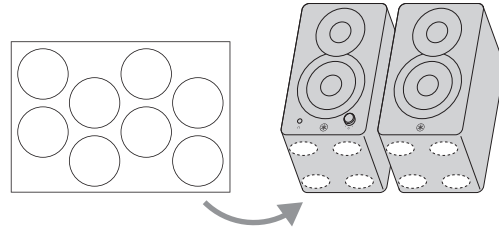

Anti Slip Pad

Paste it on the four corners of the bottom of the speaker.
Please use when placing this product on a slippery table or platform.

Cables

You'll need to acquire appropriate cables to connect the HS series monitor speakers to your audio interface or other source equipment.

- Short, high-quality cables**

Use high-quality cables of the shortest practical length. The longer the cable, the more chance there is that noise will creep in to degrade your sound.

- Balanced cables**

Balanced cables are more resistant to noise than unbalanced cables. If you have to use unbalanced cables because the source equipment only has unbalanced outputs, be sure to use the shortest possible unbalanced cables.

Connectable cables

- XLR type**

XLR type connectors are widely used in professional audio equipment and installations. The XLR type connectors provided on the HS series speakers are primarily intended for use with balanced connections.

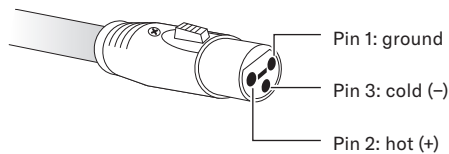
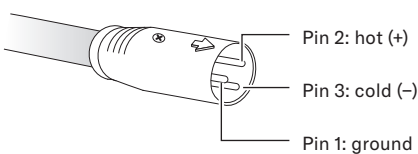

- Phone type**

Phone type connectors can be used for both unbalanced and balanced connections.

Cables fitted with TRS (tip, ring, sleeve) phone plugs are necessary for balanced connections to the HS series speakers. The construction of TRS phone plugs is basically the same as stereo phone plugs.

For unbalanced connections, connect standard mono phone plug cables to the HS speaker phone connectors.

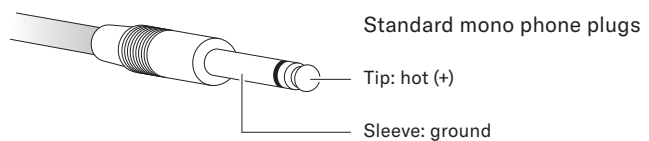
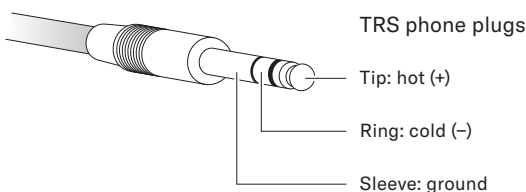

- **RCA plugs**

You can use the included stereo mini-to-RCA cable. This is an unbalanced connection.

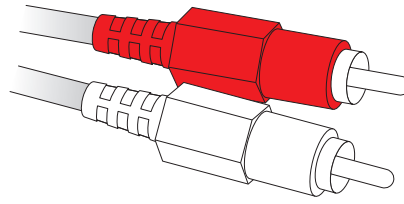

- **Stereo mini plugs**

Use an audio cable with stereo mini plugs.

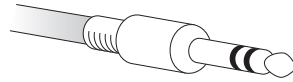

Balanced connections	These effectively cancel noise picked up from external sources. Balanced connections allow for longer cable runs that would probably otherwise result in more noise being picked up.
Unbalanced connections	Commonly used to connect electronic musical instruments and guitars, etc., to amplification equipment. If your cable runs do not extend past one or two meters, unbalanced cables can probably be used without any problems.

Setting Up for Superior Sound

This product features two speakers: an active (with built-in amplifier) speaker L and a passive speaker R. To monitor the sound accurately, position the L speaker angled towards your left side and the R speaker angled towards your right side. Speaker L is marked on the rear panel as "LEFT".

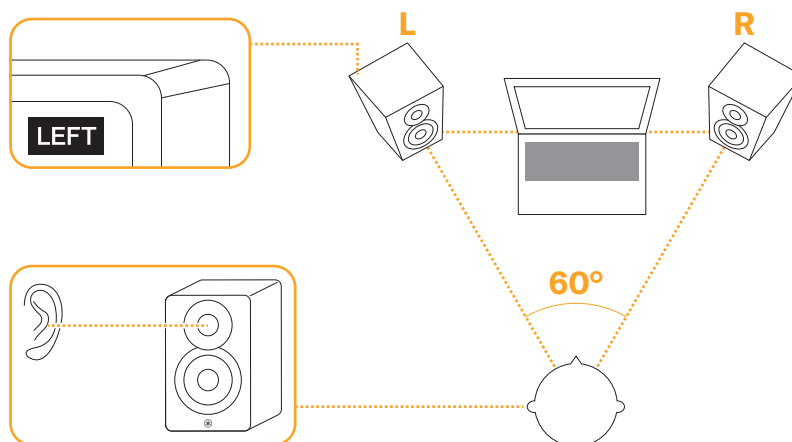

NOTICE

- Do not set the speakers up with the front side of the baffles facing down.

Keep the following points in mind when setting up your monitor speakers.

■ Position the speakers away from walls or corners

Ideally, the speakers should be located away from walls or corners. In situations where it is not possible to position the speakers a sufficient distance from walls or corners, the ROOM CONTROL switch can be used to compensate for excessive bass. As you move the speaker closer to walls or corners, a higher compensation setting may be required to achieve natural sounding response ([0] → [-2] → [-4]).

■ Position the left and right speakers symmetrically.

The left and right speakers should be positioned as symmetrically as possible in relation to the room. In other words, the left and right speakers should be the same distance from the rear wall and the respective left and right walls.

■ The optimum listening position is at the apex of an equilateral triangle.

For the most accurate sound and balance, position yourself at the apex of an equilateral triangle formed by the left and right speakers and yourself, with the speakers angled inward so that they're facing you.

■ Position the tweeters at ear height.

High frequencies are quite directional, so for the most accurate monitoring the speakers should be set up so that the tweeters are at approximately the same height as your ears when you're seated at the listening position.

Controls and Connectors

Rear

Air blowing out of the bass reflex ports is normal, and often occurs when the speaker is handling program material with heavy bass content.

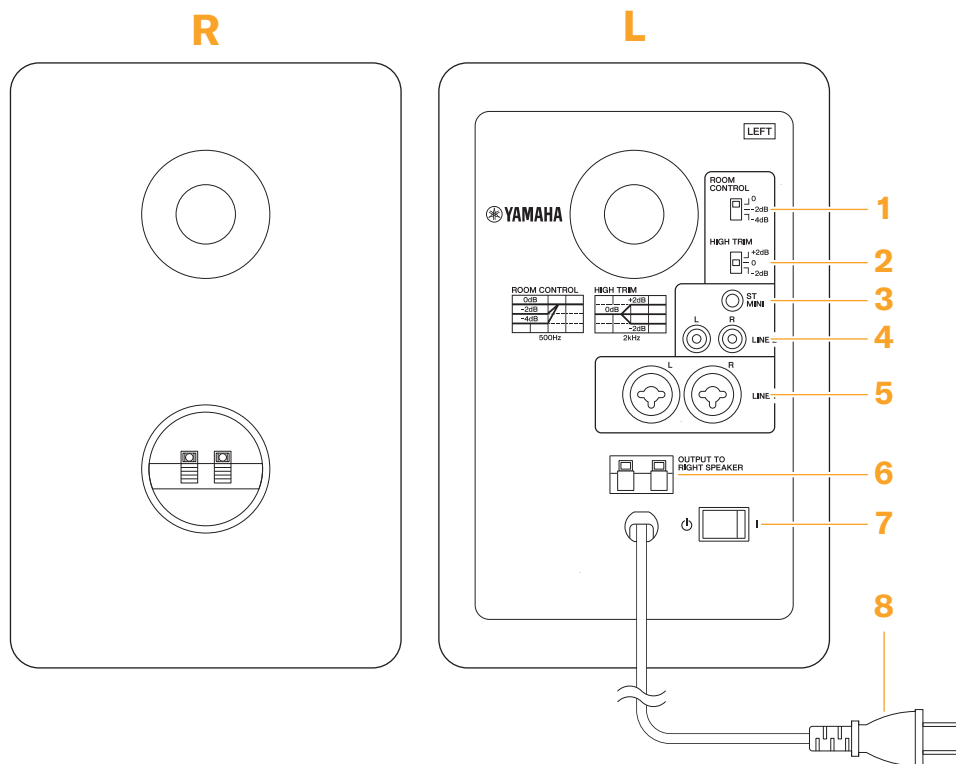

The shape of the plug differs depending on your locale.

Speaker Input and Response Control

1. ROOM CONTROL switch

Adjusts the speaker's low-frequency response. This switch can be used to compensate for exaggerated low-frequency response that can be caused by reflections in some listening environments. Setting the switch to the [0] position produces a flat frequency response. The [-2 dB] setting attenuates the range below 500 Hz by 2 dB, and the [-4 dB] setting attenuates the range below 500 Hz by -4 dB.

2. HIGH TRIM switch

Adjusts the speaker's high-frequency response. Setting the switch to the [0] position produces a flat frequency response. The [+2 dB] setting boosts the range above 2 kHz by 2 dB, while the [-2 dB] setting attenuates the range above 2 kHz by -2 dB.

3. ST MINI chassis connector

This is an unbalanced input connector used to plug in a stereo mini-plug cable. Connect your smartphone or other device here.

4. LINE 2 (L/R) chassis connectors

These sockets are unbalanced RCA input chassis connectors (L/R). Connect devices such as a computer, MP3 player or CD player here. You can use the included stereo mini-to-RCA cable.

5. LINE 1 (L/R) chassis connectors

These balanced input combo connectors are compatible with XLR connectors and phone plugs. Connect a line-level synthesizer, mixer or audio interface here.

6. OUTPUT TO RIGHT SPEAKER

Connect the included speaker cable here to transmit signals from the left speaker to the right speaker.

7. [⏻ / ⏻] (standby/on) switch

Turns the power of this product standby/on. Flip the switch to the [⏻] side to turn the power on, and flip the switch to the [⏻] side to turn the power standby.

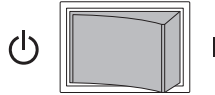

NOTICE

- Flipping the [⏻/⏻] switch to standby/on repeatedly in quick succession may cause the product to malfunction. Wait at least five seconds after turning the switch to standby before you turn it on again.
- This product features a built-in protective circuit. Excessive input signals will activate the protective circuit and shut down the power. If this happens, turn this switch to standby and wait at least three seconds before turning it on again.
- A small amount of electrical current still flows through this product's circuitry even after you've turned the [⏻/⏻] switch to standby (the switch being in the [⏻] position). If you are not going to use this product for a long time, make sure to unplug the power cord from the AC outlet.

NOTE

- There is a [⏻]/volume knob on the front panel of speaker L, which you must also turn on when you want to use the speakers.

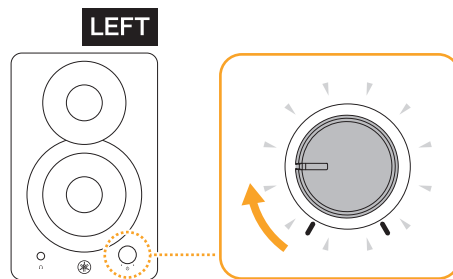

8. Power cord

Connect this cord to an AC outlet.

Front

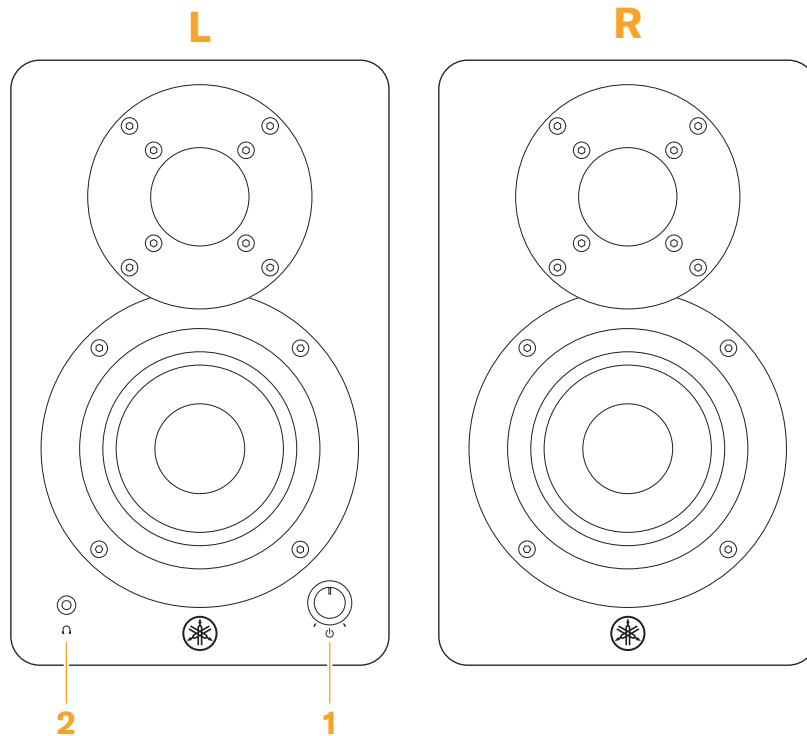

1. [⏻]/volume knob

This knob combines the features of a power and volume adjustment knob. Slightly turn the knob clockwise to turn the power on.

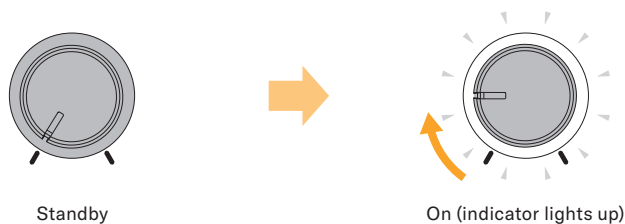

Volume adjustment

When the power is on, turn the knob clockwise to increase the volume, and turn the knob counterclockwise to decrease the volume.

Power standby

When you want to turn the power to standby, turn the knob all the way counterclockwise to its original position (the indicator goes dark).

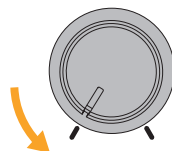

NOTICE

- Turning the [⏻]/volume knob to standby/on repeatedly in quick succession may cause the product to malfunction. Wait at least five seconds after turning the power/volume knob to standby before you turn it on again.
- This product features a built-in protective circuit. Excessive input signals will activate the protective circuit and shut down the power. If this happens, turn the power switch on the rear panel of this product off and wait at least three seconds before turning it on again.
- A small amount of electrical current still flows through this product's circuitry, even after you've turned the [⏻]/volume knob to standby and the indicator goes dark. If you are not going to use this product for a long time, make sure to unplug the power cord from the AC outlet.

2. Headphones socket

Connect a pair of headphones here. No sound comes out of the speakers while headphones are connected.

Connections

WARNING

- Before connecting the product to other devices, turn off the power for all devices. Also, before turning the power of all devices on or off, make sure that all volume levels are set to the minimum. Failing to do so may result in hearing loss, electric shock, or device damage.
- When turning on the AC power in your audio system, always turn on the product LAST, to avoid hearing loss and speaker damage. When turning the power off, the product should be turned off FIRST for the same reason.

Connecting the speakers with the included cable

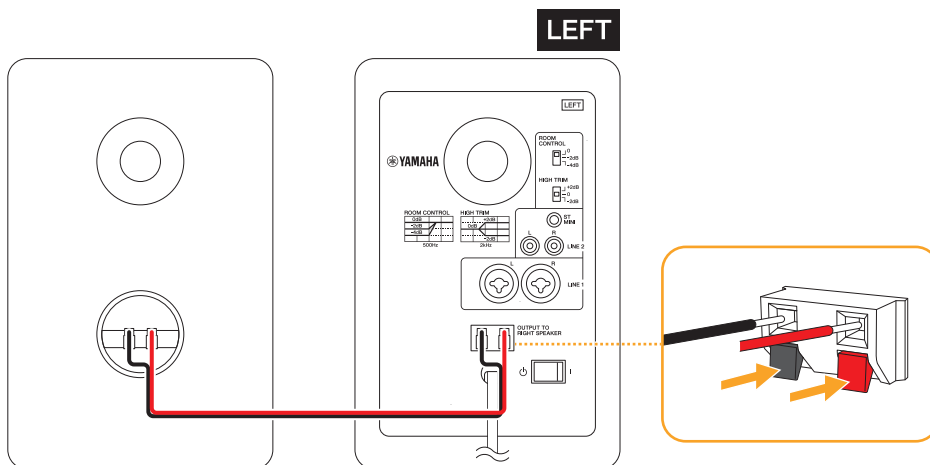

Connect the red lead to the red terminal and the black lead to the black terminal.

Connecting to an Audio Interface

When connecting an audio interface to HS series speakers, connect the audio interface output connectors directly to the speakers' input connectors. Normally you'll connect to the LINE OUT 1 and 2 (1L and 2R outputs), although that might depend on the specific audio interface and DAW (Digital Audio Workstation) settings used.

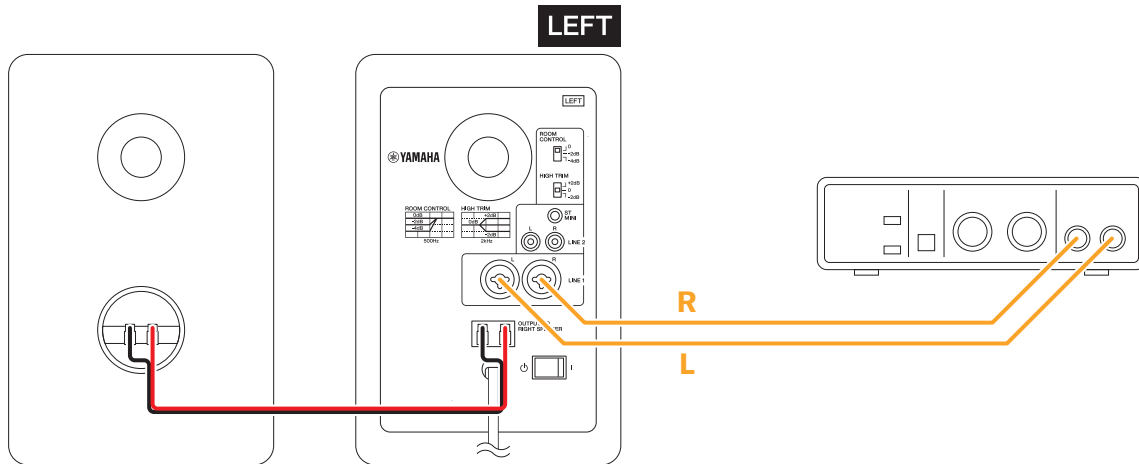

Recommended cables

● For connection to a balanced phone chassis connector



1/4" TRS phone cables
or



XLR-to-1/4" TRS phone cables

● For connection to an unbalanced phone chassis connector



1/4" Standard mono phone cables

NOTE

- Refer to **“Connectable cables”** for more connector details. The configurations of the balanced and unbalanced phone chassis connectors are different.

Connecting to a Mixer

When connecting a mixer to HS series speakers, connect the mixer's MONITOR OUT or C-R OUT (Control Room) connectors directly to the speakers' input connectors. This makes it possible to control the monitor level independently from the mixer's main bus level.

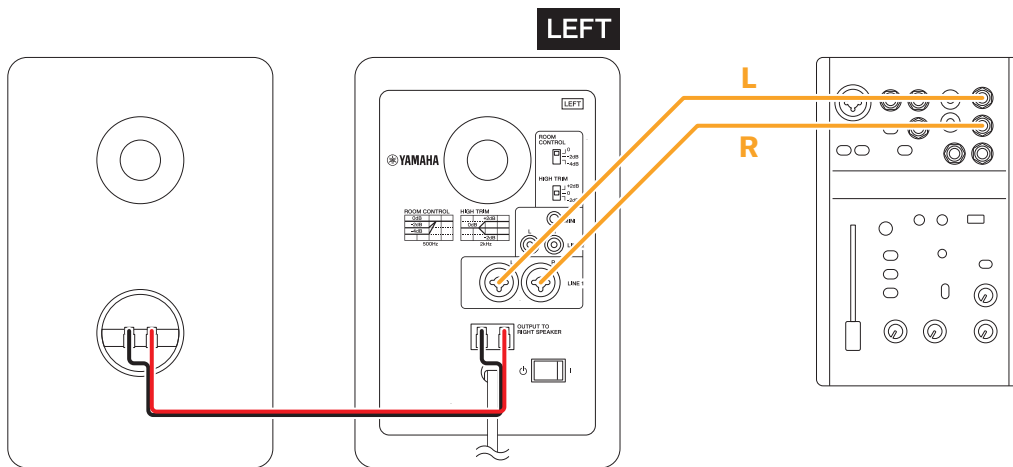

Recommended cables

- For connection to a balanced XLR chassis connector



XLR cables

- For connection to a balanced phone chassis connector



1/4" TRS phone cables

- For connection to an unbalanced phone chassis connector



1/4" Standard mono phone cables

NOTE

- Refer to **“Connectable cables”** for more connector details. The configurations of the balanced and unbalanced phone chassis connectors are different.

Connecting to a Synthesizer or Other Electronic Musical Instrument

When connecting an electronic musical instrument to the HS series speakers, connect the instrument's L/MONO and R outputs to the HS speaker inputs.

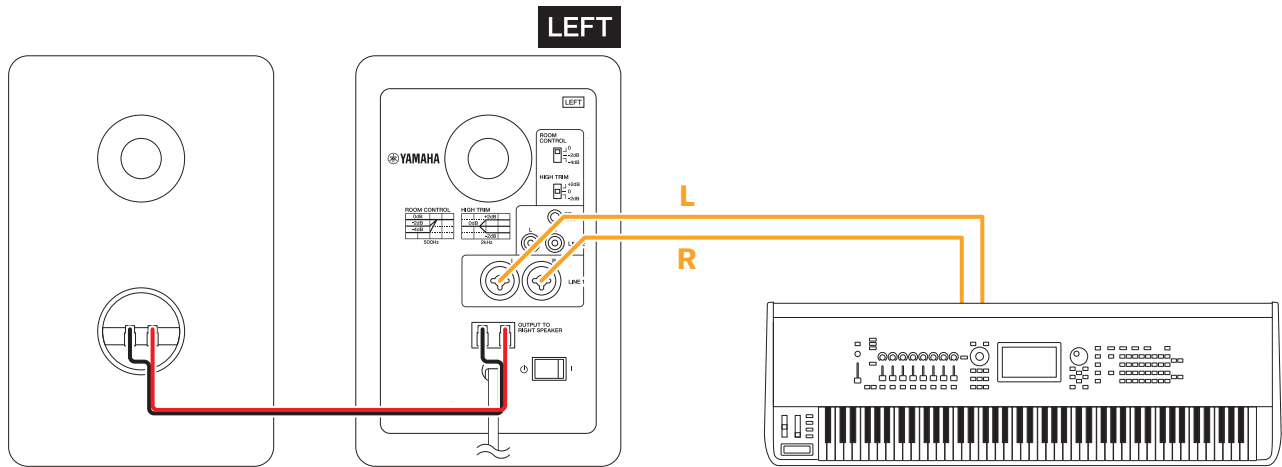

Recommended cables

- For connection to an unbalanced phone chassis connector



1/4" Standard mono phone cables

NOTE

- Refer to **“Connectable cables”** for more connector details. The configurations of the balanced and unbalanced phone chassis connectors are different.

Connecting to a computer

Use the included stereo mini-to-RCA cable to connect the headphones output connector on your computer to the RCA connectors on this product.

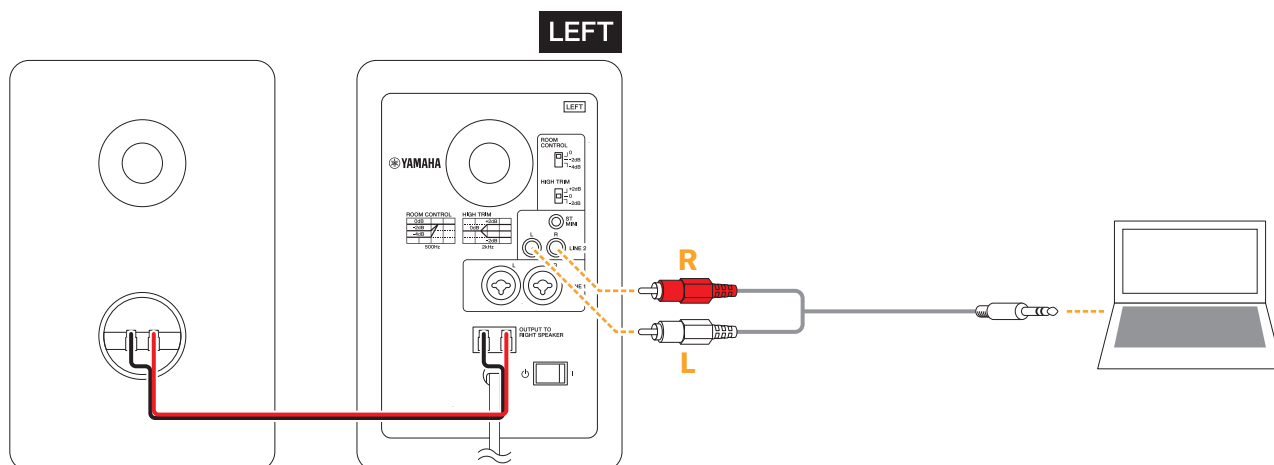

Use a commercially available stereo mini-plug cable to connect the headphones output connector on your computer to the ST MINI connector on this product.

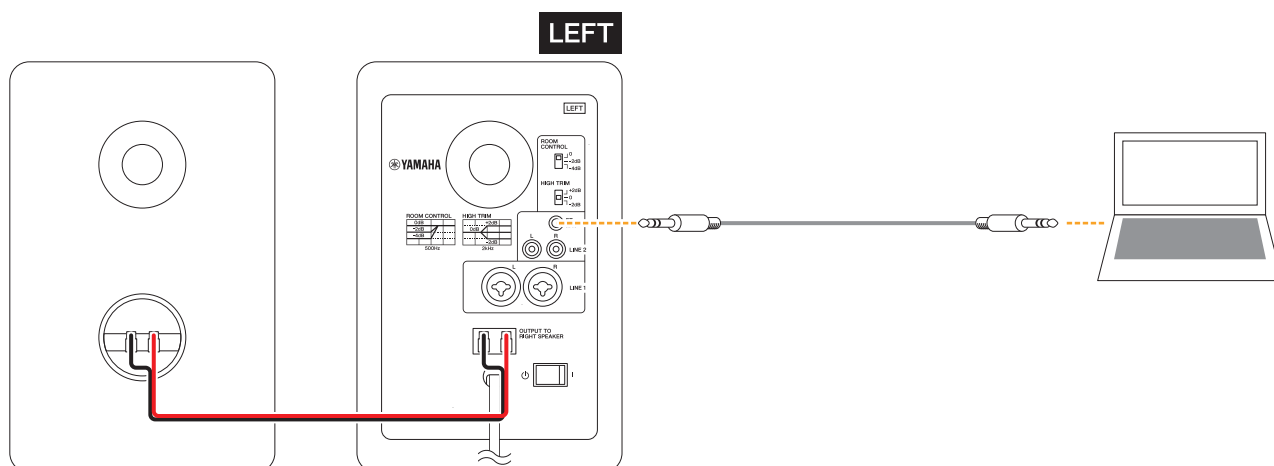

Connecting to a smartphone

Use the included stereo mini-to-RCA cable to connect the earphone connector on your smartphone to the RCA connectors on this product.

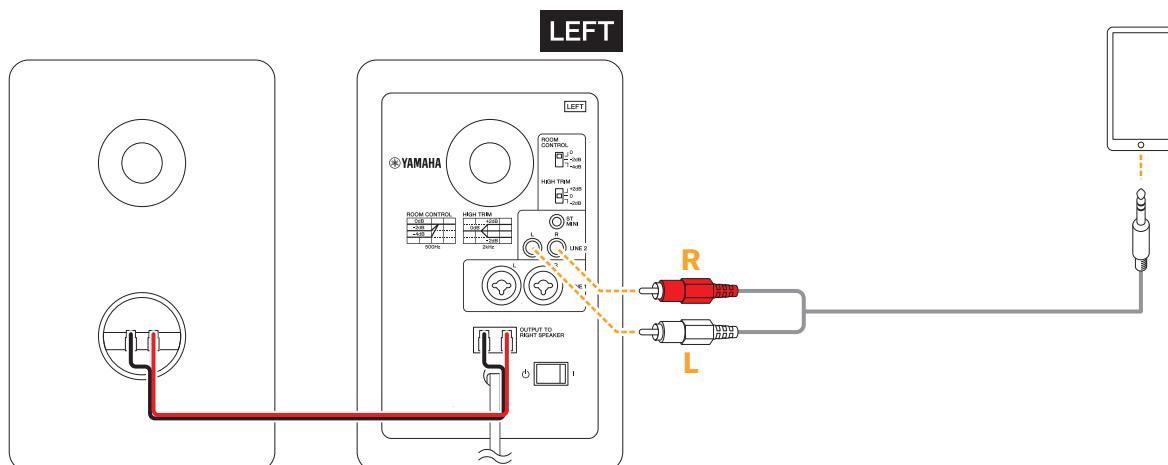

Use a commercially available stereo mini-plug cable to connect the earphone connector on your smartphone to the ST MINI connector on this product.

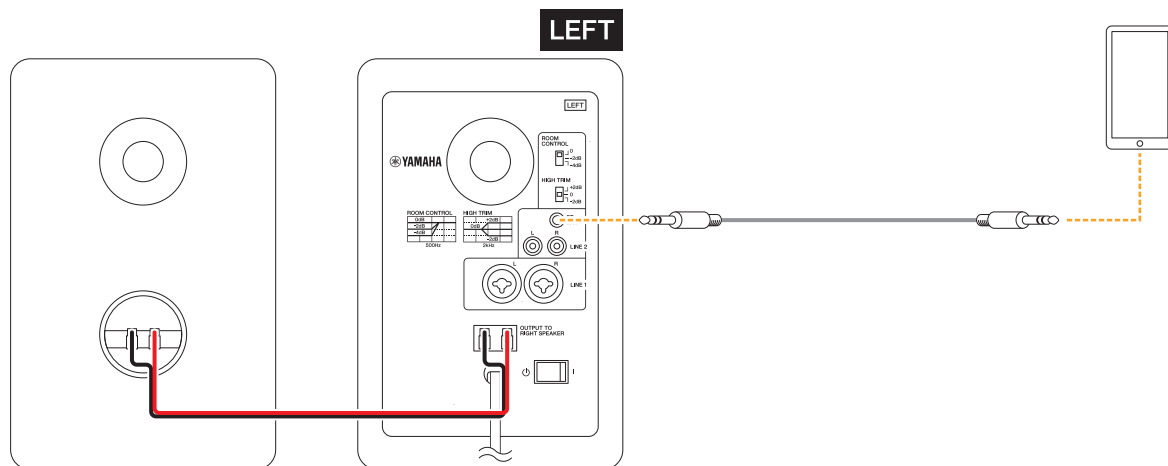

NOTE

- For smartphones running Android with a USB-C port for audio input/output, use a USB-C to 3.5 mm four-conductor earphone jack adapter cable. For iPhones with a Lightning connector, use a Lightning-3.5 mm headphone jack adapter.

Connecting headphones

Connect a pair of headphones features a stereo mini-plug cable.

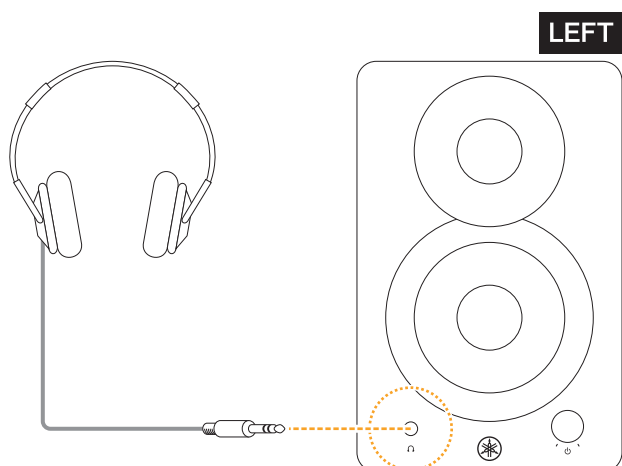

Turning on the power and making sound

Once you've set up the speakers, make the settings by following the steps below.

1. Before connecting this product, make sure that all the devices connected to this product are turned off.

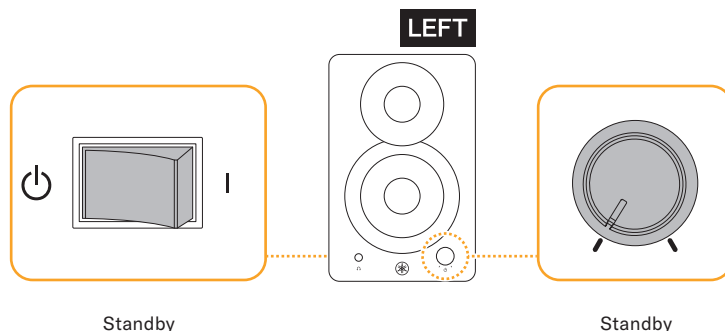

2. Turn the output level of the connected devices (such as audio interfaces) down to minimum.

3. Connect speakers L and R with the included speaker cable.

⚠ CAUTION

- You can also use a commercially available speaker cable, but make sure that the cable is designed only for use with speakers. Using other kinds of cables may cause a fire.

4. Connect any external devices, and plug in the power cord of this product.

5. Set the ROOM CONTROL and HIGH TRIM switches on this product to 0 db.

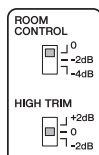

6. Turn on the power of your connected devices, and then turn this product on (first the rear switch and then the front knob).

The power/volume knob on the front panel turns the speakers on when you slightly turn the knob clockwise, and the indicator lights up.



⚠ WARNING

- When turning the power off, turn off the power of this product (first the front knob and then the rear switch), and then turn off any connected devices.

7. Adjust the volume.

The [⏻]/volume knob on the front panel is also used to adjust the volume. Turn this knob in either direction while the indicator is lit to adjust the volume. In this example, turn the knob to the 12-o'clock position.

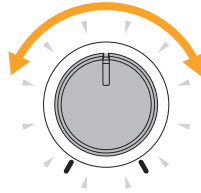

8. Output a signal from the connected device and gradually increase the level.

NOTICE

- Be careful not to suddenly apply an excessively loud signal to the system. Excessive level can damage the speakers.

9. Set the knob to a level that's comfortable to listen at for an extended period of time.

NOTE

- Change the ROOM CONTROL and HIGH TRIM switch settings as necessary.

Troubleshooting

Symptom	Possible Cause	Solution
The speakers do not turn on, or the front panel indicator does not light up.	The power cord might not be connected properly.	Connect the power cord properly.
	The power switch might not be turned on.	Turn the power switch and knob on (first the rear switch and then the front knob). If the power still does not turn on, contact your Yamaha dealer.
No sound.	One or more cables might not be connected properly.	Connect the cables properly.
	No signal output is received from external devices.	Make sure that the external devices are outputting signals.
	The level setting might be too low.	Raise the output level from the external devices.
The sound is noisy or distorted.	One or more cables might be corroded, shorted or otherwise broken.	Replace any faulty cables.
	The speakers might be picking up external noise.	Try changing the position or layout of the cables.
		Try changing the location of other devices near the speakers.

Specifications

0dBu is referenced to 0.775Vrms

		HS4	HS3
General Specifications			
System Type		2-way Powered speaker	
Frequency Response (-3 dB)		83 Hz - 20 kHz	85 Hz - 20 kHz
Frequency Response (-10 dB)		60 Hz - 22 kHz	70 Hz - 22 kHz
Crossover Frequency		2.3 kHz	3.2 kHz
Maximum Output Level (Measured peak, IEC noise@1m)		102 dB SPL	100 dB SPL
Dimensions (W×H×D)	L Side	150×240×213 mm	132×223×189 mm
	R Side	150×240×203 mm	132×223×177 mm
Weight	L Side	3.7 kg	2.8 kg
	R Side	3.1 kg	2.1 kg
Input Connector	L Side	COMBO (XLR/TRS Phone) ×2	
		RCA ×2	
	R Side	Stereo Mini	
		Speaker Input	
Output Connector	L Side	Headphone	
		Speaker Output	
Speaker section			
Enclosure		Bass-reflex type, Material: MDF	
Speaker Components		HF: 1" Dome	HF: 0.75" Dome
		LF: 4.5" Cone	LF: 3.5" Cone
Nominal Impedance		6 Ω	
Amplifier section			
Maximum Output	Dynamic, RL=6 Ω	26 W + 26 W	
	THD 0.1%, 1kHz, RL=6 Ω	20 W + 20 W	
Input Impedance		LINE 1 (COMBO): 20 kΩ, LINE 2 (RCA, ST Mini): 10 kΩ	
Input Sensitivity (Volume: Maximum)		LINE 1 (COMBO): +4 dBu, LINE 2 (RCA, ST Mini): -10 dBu	
Maximum Input		LINE 1 (COMBO): +20 dBu, LINE 2 (RCA, ST Mini): +6 dBu	
Input Connectors		LINE 1: COMBO (XLR/TRS PHONE)	
		LINE 2: RCA, Stereo Mini	
Controls		Front: Volume	
		ROOM CONTROL SWITCH	
		HIGH TRIM SWITCH	
Indicator		Power ON (White LED)	
Power Requirements (*)		Depending on area of purchase; 100-240 V, 50/60 Hz	
Power Consumption		15 W	
Accessories			
Included in the package		Stereo Mini - RCA Cable 1.5 m	
		Speaker Cable 2.5 m	
		Anti Slip Pad	
		Quick Start Guide	
		Safety Guide	

* While this product will work at a voltage of between 100 V to 240 V, as limiter settings vary depending on the supply voltage, make sure to use this product at the supply voltage indicated on the rear panel of this product.

The contents of this manual apply to the latest specifications as of the publishing date.

Dimensions

HS4 Left

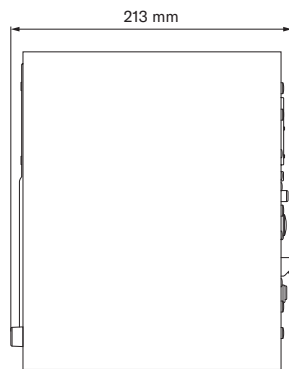
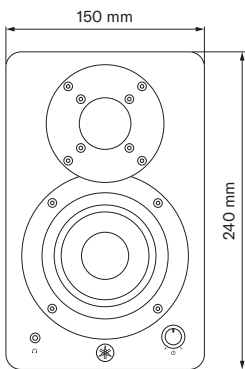
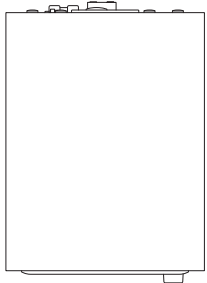

HS4 Right

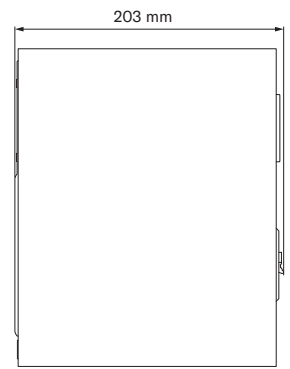
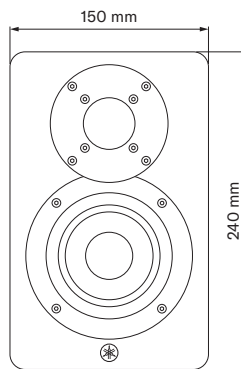

HS3 Left

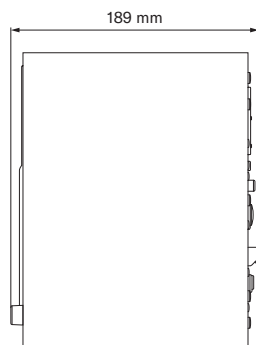
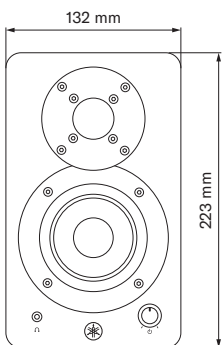
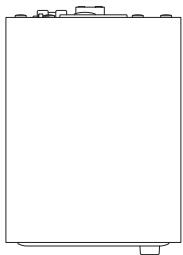

HS3 Right

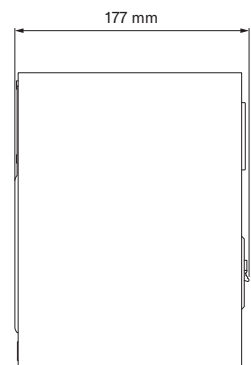
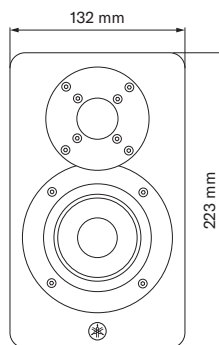

Frequency Response

HS4

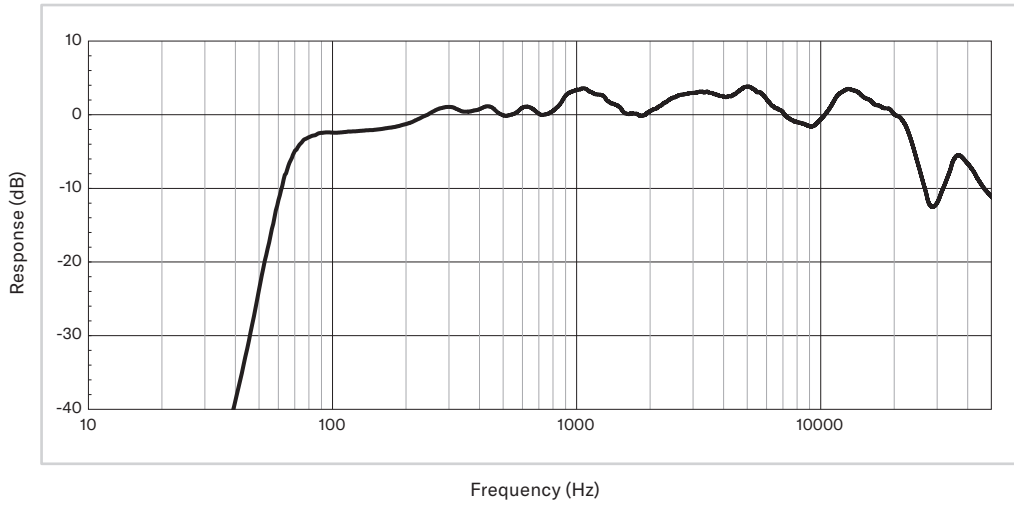

HS3

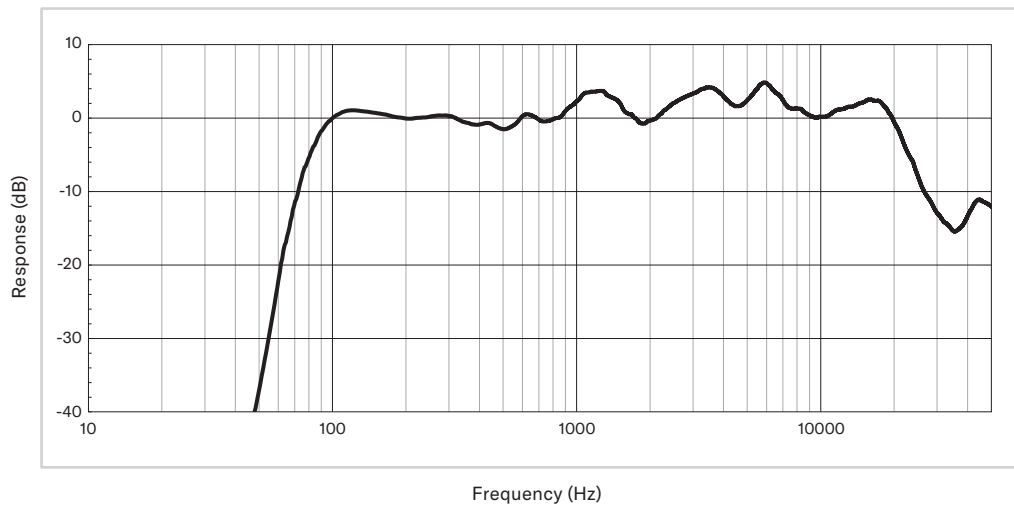

Block Diagram

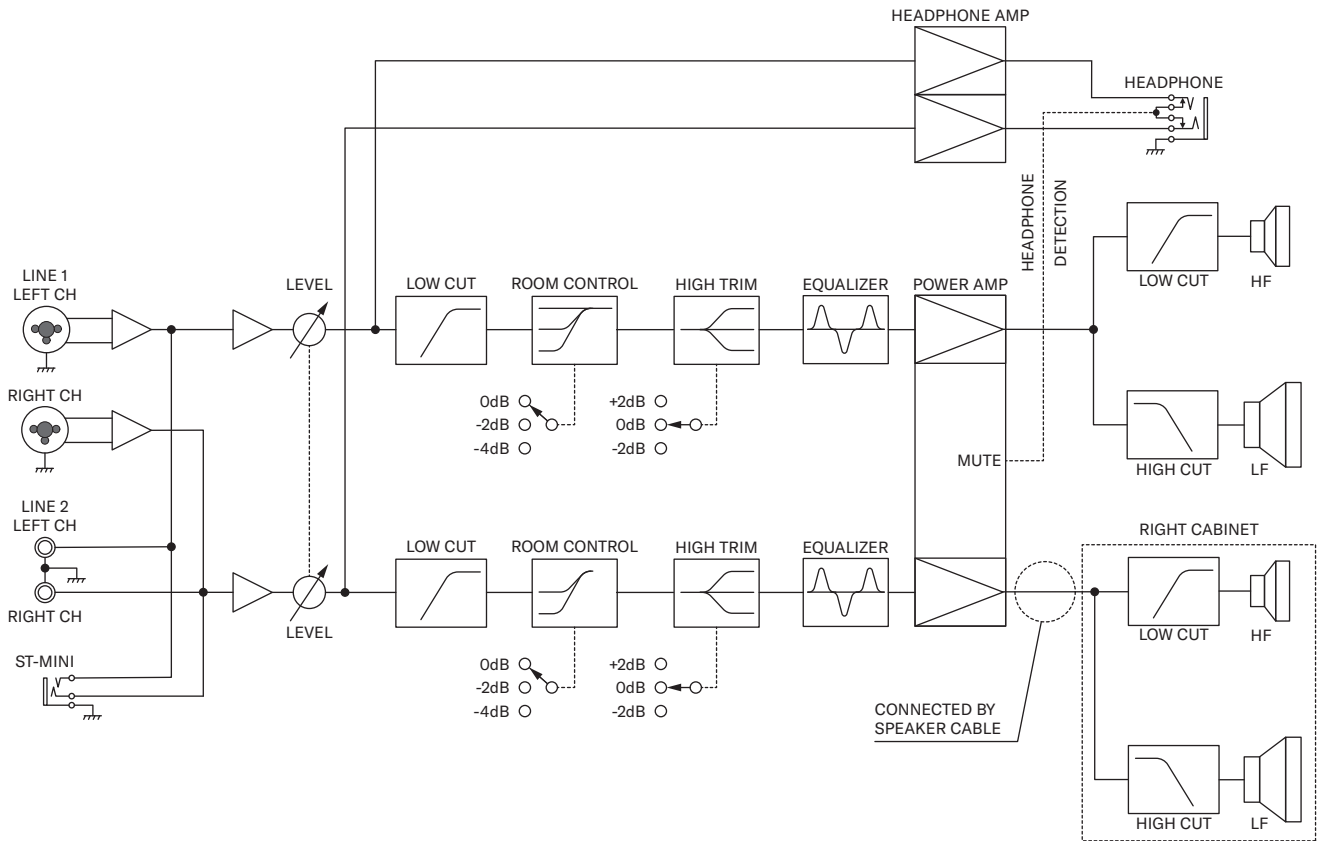

Yamaha Pro Audio global website

<https://www.yamahaproaudio.com/>

Yamaha Downloads

<https://download.yamaha.com/>