

# ProVisionaire Design

## V1.2 User Guide

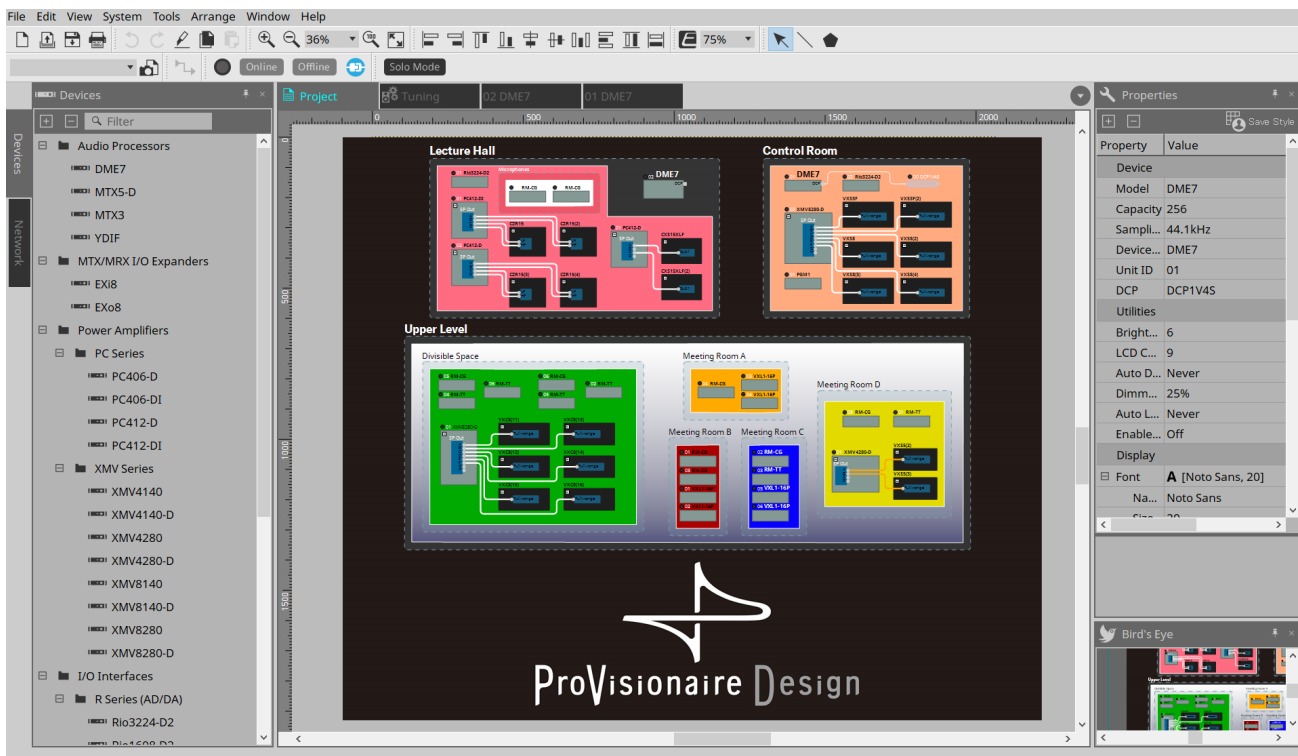

# Contents

1. Introduction . . . . .	9
1.1. Information . . . . .	9
1.2. Terms and concepts to understand . . . . .	10
1.3. Operating requirements and installation . . . . .	11
1.3.1. Operating requirements . . . . .	11
1.3.2. Installation . . . . .	11
1.4. An overview of ProVisionaire Design . . . . .	12
2. Screen structure. . . . .	13
2.1. Common to all sheets . . . . .	15
2.2. "Project" sheet. . . . .	17
2.3. Linked Presets . . . . .	17
2.4. "Tuning" sheet for PC series/XMV series only . . . . .	18
2.5. Device sheet . . . . .	19
3. The basics of using ProVisionaire Design . . . . .	20
3.1. Connecting the devices . . . . .	20
3.2. Procedure . . . . .	20
3.2.1. If you can connect the device(s) to the computer . . . . .	21
3.2.2. If you cannot connect the device(s) to the computer . . . . .	25
4. Menu bars and toolbar . . . . .	29
4.1. [File] menu . . . . .	29
4.2. [Edit] menu. . . . .	30
4.3. [View] menu. . . . .	32
4.4. [System] menu . . . . .	32
4.5. [Tools] menu . . . . .	33
4.6. [Arrange] menu . . . . .	33
4.7. [Window] menu . . . . .	34
4.8. [Help] menu . . . . .	35
4.9. Buttons only on the toolbar . . . . .	35
5. Shortcut keys . . . . .	37
6. List of alerts . . . . .	40
6.1. Power amplifiers. . . . .	40
6.2. Processor . . . . .	40
7. "Project" sheet . . . . .	41
7.1. "Project" sheet. . . . .	41
7.2. "Devices" area . . . . .	41
7.3. "Network" area . . . . .	42
7.3.1. "Change Unit ID" dialog box . . . . .	42
7.4. "Properties" area . . . . .	45
7.5. Placing devices . . . . .	47
7.6. Selecting multiple objects . . . . .	48
7.7. Connecting ports . . . . .	49
7.8. Duplicating devices . . . . .	50
7.9. "Group" Editor . . . . .	51
8. "Tuning" sheet . . . . .	52
8.1. "Tuning" sheet . . . . .	53
8.2. "Properties" area . . . . .	53
8.3. "Project Devices" area . . . . .	54
8.3.1. [Amplifiers]. . . . .	54
8.3.2. [Speakers]. . . . .	54
8.4. "Link Groups" area . . . . .	55

---

9. Online and synchronization	56
9.1. Online	56
9.1.1. "Synchronization" dialog box	56
9.1.2. Procedure	57
9.1.3. 「Go Online- From Devices」 dialog box	58
9.2. Offline	60
9.2.1. "Offline" dialog box	60
10. Dialog boxes	61
10.1. Startup dialog box	61
10.2. "Go Online- From Devices" dialog box	62
10.3. "Protect File" dialog box	63
10.4. "Project Information" dialog box	64
10.5. "Print" dialog box	65
10.6. "File Storage" dialog box	67
10.6.1. [File Manager] dialog box	68
10.7. "Network Setup" dialog box	69
10.8. "IP Settings" dialog box	70
10.9. "IP Address" dialog box	72
10.10. "Auto-Assign IP Addresses" dialog box	78
10.11. "Match Devices by IP Address" dialog box	79
10.12. "Device Information" dialog box	82
10.12.1. "Detail>>" area	84
10.13. "Update Firmware" dialog box	85
10.14. "Initialize" dialog box	87
10.15. "Word Clock" dialog box	90
10.16. "Protect Devices" dialog box	92
10.17. "Clock" dialog box	94
10.17.1. RM Series	94
10.17.2. Non-RM Series	95
10.18. "Daylight Saving Time" dialog box	97
10.19. "GPI Calibration" dialog box	99
10.20. "Get Log from Devices" dialog box	101
10.21. "RM Series Settings" > "Sign up" dialog box	102
10.22. "RM Series Settings" > "Login" dialog box	103
10.23. "RM Series Settings" > "Password Settings" dialog box	104
10.24. "RM Series Settings" > "Enable SCP remote control access" dialog box	105
10.25. "Linked Presets Manager" dialog box	106
10.26. "Store Linked Preset" dialog box	108
10.27. Port Label Dialog	109
11. Context menus	110
11.1. Sheet tabs	110
11.2. "Project" sheet	110
11.2.1. Device in the "Project" sheet	110
11.2.2. Speaker in the "Project" sheet	111
11.2.3. Device group in the "Project" sheet	112
11.2.4. Text, Line, or Polygon in the "Project" sheet	112
11.2.5. Wire in the "Project" sheet	113
11.2.6. "Network" area	113
11.3. Device sheet	113
11.3.1. Components and component editors in the device sheet	113
12. Common operations for device sheets	114
12.1. Component editor operations	114

---

12.2. Editing the parameters .....	115
12.3. Registering parameters to ProVisionaire Control.....	117
13. Audio Processors: DME7 .....	118
13.1. Overview .....	118
13.2. "Project" sheet .....	118
13.2.1. Tool bar .....	119
13.2.2. "Properties" area .....	120
13.3. Device sheet screen configuration.....	122
13.4. Basic use of ProVisionaire Designer.....	123
13.5. Tool buttons .....	125
13.6. "Components" area .....	126
13.7. Design sheet .....	127
13.7.1. Placing components.....	127
13.7.2. Selecting multiple components, ports, or wires .....	128
13.7.3. Connecting ports.....	129
13.7.4. Tracing the signal path.....	130
13.7.5. Duplicating an input port name .....	131
13.7.6. About [Unbundle Wires] .....	132
13.7.7. Duplicating components .....	133
13.8. Design sheet: Audio layer .....	134
13.8.1. Audio Component.....	134
13.9. Design sheet: Control layer .....	134
Control Component .....	134
13.9.1. Using the audio component parameters in the Control layer .....	134
13.9.2. Controlling a Snapshot and ParamSet in the control component.....	136
13.10. Components other than audio or control components .....	138
13.10.1. Transmitter/Receiver .....	138
13.10.2. User Defined Block .....	140
13.10.3. Text.....	143
13.11. "Parameter Sets" area .....	144
13.11.1. Parameter Sets .....	145
13.11.2. Snapshot .....	146
13.11.3. Recall .....	146
13.11.4. Related Features.....	147
13.11.5. "Recall Settings" dialog box.....	148
13.12. "Properties" area .....	149
13.13. "Parameters" area .....	150
13.14. Context Menu .....	151
13.14.1. Design sheet .....	151
13.14.2. Components .....	151
13.14.3. Component Ports .....	152
13.14.4. Component editor / Parameter setting window .....	152
13.14.5. Wire.....	152
13.14.6. "Parameter Sets" area .....	154
13.14.7. "Parameters" area.....	154
13.15. Dialog box .....	155
13.15.1. "Compile" dialog box .....	155
13.15.2. "Remote Control Setup List" dialog box .....	158
13.15.3. "SD Card File Manager" dialog box.....	162
13.15.4. "GPI" dialog box.....	165
13.15.5. "MIDI" dialog box.....	174
13.16. Message List .....	177

---

---

14. Audio Processor MRX7-D	183
14.1. Overview	183
14.2. Project Sheet	184
14.2.1. Toolbar	184
14.2.2. Devices Area	185
14.2.3. Properties Area	186
14.3. Device Sheet Screen Configuration	189
14.4. Basic Use	190
14.5. Tool Buttons	191
14.6. Components Area	193
14.7. Design Sheet	193
14.8. Non-Audio Components	193
14.9. Parameter Sets Area	194
14.9.1. Snapshot Group	195
14.9.2. Steps to create a snapshot group	196
14.10. Presets Area	197
14.10.1. Procedure	198
14.11. Parameter Link Group Area	199
14.11.1. Link Control Editor	200
14.12. Gang Edit Group Area	201
14.12.1. Procedure	202
14.13. Properties Area	203
14.14. Parameters Area	204
14.15. Context Menu	204
14.16. Dialog	205
14.16.1. Compile Dialog	205
14.16.2. Remote Control Setup List Dialog	206
14.16.3. File Transfer Application	208
14.16.4. SD Card File Manager Dialog	209
14.16.5. Scheduler Dialog	209
14.16.6. GPI Dialog	209
14.16.7. External Events Dialog	209
14.16.8. Install Speech Privacy File Dialog	210
14.17. Component Editor	211
14.17.1. Acoustic Echo Canceller Component Editor	211
14.17.2. [Effect] Component Editor	213
14.17.3. Analog In Component Editor	214
14.17.4. Slot In Component Editor	215
14.17.5. Analog Out Component Editor	216
14.17.6. Slot Out Component Editor	217
14.17.7. Speech Privacy Component Editor	218
14.18. Alert List	219
14.19. Flow of Paging Configuration	219
15. Audio Processors: MTX5-D/MTX3	220
15.1. Overview	220
15.2. "Project" sheet	220
15.2.1. "Devices" area	220
15.2.2. "Properties" area	221
15.3. Device sheet screen configuration	223
15.4. Tool buttons	224
15.5. "Presets" area	225
15.5.1. Recall	226

---

15.6. Context menus	227
15.6.1. MTX5-D sheet/MTX3 sheet	227
15.6.2. Components/in the MTX/component editor	227
15.7. Dialog box	228
15.7.1. "MTX Configuration" dialog box	228
15.7.2. "SD Card File Manager" dialog box	230
15.7.3. "Scheduler" dialog box	231
15.7.4. "GPI" dialog box	239
15.7.5. "External Events" dialog box	245
15.7.6. "Recall Settings" dialog box	248
15.7.7. "Recall Filter" dialog box	250
15.7.8. "Sampling Rate Converter" dialog box	253
15.8. Alert list	254
15.9. Component editors	257
15.9.1. "Analog In" component editor	260
15.9.2. "MY4-AEC" component editor	261
15.9.3. "Input CH" component editor	266
15.9.4. "Insert" component editor	268
15.9.5. "Zone" component editor	269
15.9.6. "Output CH" component editor	276
15.9.7. "Pilot Tone" component editor	278
15.9.8. "Analog Out" component editor	279
15.9.9. "Slot Out" component editor	280
15.9.10. "DCA Groups"/"Mute Groups" component editor	281
15.10. Workflow for paging settings	283
16. MTX I/O Expanders: EXi8 / Exo8	286
16.1. Overview	286
16.2. "Project" sheet	286
16.3. Editor	287
17. Power Amplifiers: PC-series	289
17.1. Overview	289
17.2. "Project" sheet	289
17.2.1. PC-D and speaker connections	290
17.2.2. "Properties" area	290
17.2.3. Speaker Editor / Multiple Speaker Editor	291
17.3. "Tuning" sheet	292
17.3.1. Link group editor	292
17.3.2. [User EQ/Volume] tab	293
17.3.3. [User Delay] tab	295
17.4. Device sheet screen configuration	297
17.5. "Presets" area	298
17.5.1. "Store Preset" dialog box	299
17.6. Context Menu	300
17.6.1. "Tuning" sheet	300
17.6.2. Link group in the "Tuning" sheet	300
17.6.3. "Project Devices" area	300
17.6.4. "Link Groups" area	301
17.6.5. Device sheet	301
17.6.6. Components in the device sheet/component editor	301
17.6.7. "Presets" area	301
17.7. Alert list	302
17.8. Component editors	306

---

---

17.8.1. "Power" component editor	308
17.8.2. "Input Alignment" component editor	309
17.8.3. "User EQ/User Delay" component editor	310
17.8.4. "Speaker Processor" component editor	311
17.8.5. "Amplifier" component editor	313
17.8.6. "Speaker Out" component editor	315
18. Power Amplifiers: XMV-series	316
18.1. Overview	316
18.2. "Project" sheet	316
18.2.1. "Properties" area	317
18.3. Tuning Sheet	319
18.3.1. Link group editor	319
18.3.2. "ATT"	319
18.3.3. "LINK MAIN"	319
18.4. Device sheet screen configuration	321
18.5. Context Menu	322
18.5.1. "Tuning" sheet	322
18.5.2. Link group in the "Tuning" sheet	322
18.5.3. "Project Devices" area	322
18.5.4. "Link Groups" area	323
18.6. Alert list	324
18.7. Component editors	328
18.7.1. "Power/ATT/Polarity" component editor	330
18.7.2. "Redundancy" component editor	331
18.7.3. "Speaker Out" component editor	332
18.7.4. "YDIF Patch" component editor	333
19. I/O Interface: Rio3224-D2 / Rio1608-D2	334
19.1. Overview	334
19.2. "Project" sheet	334
19.3. Editor	335
19.4. Context menu	335
20. I/O Interface: Tio1608-D / Tio1608-D2	336
20.1. Overview	336
20.2. "Project" sheet	336
20.3. Editor	337
21. I/O Interface: RSio64-D	338
21.1. Overview	338
21.2. "Project" sheet	338
21.3. Editor	339
22. Powered Speakers: VXL1-16P	343
22.1. Overview	343
22.2. "Project" sheet	343
22.3. Device sheet screen configuration	344
22.4. Component editors	345
23. Microphones: PGM1	347
23.1. Overview	347
23.2. "Project" sheet	347
23.3. "Properties" area	348
24. Microphones: RM-CG	349
24.1. Overview	349
24.2. "Project" sheet	349
24.3. [System] menu	350

24.4. "Network" area	350
24.5. "Properties" area	351
24.6. Device sheet screen configuration	352
24.7. Tool buttons	352
24.8. Component editors	353
24.8.1. "Microphone Settings" component editor	354
24.8.2. "DSP Settings" component editor	356
24.8.3. "Mute Settings" component editor	358
25. Microphones: RM-TT	359
25.1. Overview	359
25.2. "Project" sheet	359
25.3. [System] menu	360
25.4. "Network" area	360
25.5. "Properties" area	361
25.6. Device sheet screen configuration	362
25.7. Tool buttons	362
25.8. Component editors	363
25.8.1. "Microphone Settings" component editor	364
26. External Device: Speakers	366
26.1. Overview	366
26.2. "Project" sheet	366
26.3. "Properties" area	367
26.4. "Recall Speaker Preset(s)" dialog box	368
27. DCP	369
27.1. Overview	369
27.2. How to select the DCP to be connected	369
27.3. Setting method for DME7	371
27.3.1. DCP component setting	371
27.3.2. [Parameter Assign] tab	371
27.3.3. [Dimmer & Lock] tab	376
27.4. Setting method for MTX5-D/MTX3	377
27.4.1. DCP component settings	377
27.4.2. DCP component: Settings dialog (switch)	379
27.4.3. DCP component: Settings dialog (knob)	384
27.5. MRX7-D Setting Method	388
27.5.1. DCP Component Settings	388
27.5.2. [Parameter Assign] Tab	389
27.5.3. [Dimmer & Lock] Tab	393
27.5.4. [Source Select] Tab	393
28. Wall-mount Controller: MCP1	394
28.1. Overview	394
28.2. Project Sheet	394
28.2.1. Properties Area	395
28.3. Setting Method	396
28.4. Component Editor	399
28.4.1. [Dimmer & Lock] Tab	400
28.4.2. Controlled Devices Dialog	401
28.4.3. Preset List Dialog	403
28.4.4. Label Dialog	404
28.4.5. Settings dialog	406
28.5. Alert List	413
29. YDIF	414



29.1. YDIF .....	414
29.2. YDIF setting method (Project sheet) .....	414
29.3. YDIF setting method (device sheets).....	416
30. Settings for controlling devices across subnets .....	417

---

# 1. Introduction

Thank you for downloading Yamaha ProVisionaire Design.

ProVisionaire Design is a software application for Windows that enables you to design and configure an integrated audio system consisting of Yamaha products. You can configure audio processing settings that will optimize various situations and applications by designing audio routings and adjusting parameters for each component.

For details on the models that are supported, refer to the relevant manuals on the Yamaha Pro Audio website.

Download the manuals that you need.

<https://www.yamahaproaudio.com/>

## 1.1. Information

- All copyrights for this software and user guide are the property of Yamaha Corporation.
- Unauthorized copying or modification of this software or user guide in part or in whole is prohibited.
- Please be aware that Yamaha Corporation accepts no responsibility for any results or consequences that may follow from the use of this software and user guide.
- All of the illustrations and screen shots in this user guide are provided for the purpose of explaining operations. For this reason, they may differ from the actual specifications.
- Windows is a registered trademark of Microsoft Corporation USA in the United States and in other countries.
- iPad is a trademark of Apple Inc. registered in the United States and in other countries.
- Please be aware of copyright when using audio sources for a commercial purpose. Infringement of copyright is prohibited by law.
- Company names and product names appearing in this document are the trademarks or registered trademarks of their respective owners.
- The application software may be updated without notice for improvement. The latest application software can be downloaded from the Yamaha Pro Audio website.  
<https://www.yamahaproaudio.com/>

## 1.2. Terms and concepts to understand

### Software

The following software related to ProVisionaire Design is available.

Software	Summary
ProVisionaire Control	Software for designing remote controllers that operate on a Windows PC or on iPad.
ProVisionaire Edge	Software used to monitor devices on a local network.
ProVisionaire Control KIOSK	Software optimized for remote control operating on a Windows PC.
ProVisionaire Touch KIOSK	Software optimized for remote control operating on iPad.
ProVisionaire Portal	Software used to activate a Device License.
ProVisionaire Cloud	Cloud service used to manage Device Licenses.

### Terms

In ProVisionaire Design, the following terms are used when discussing the structure of a system.

Term	Summary
Project	A group of devices handled by ProVisionaire Design.
Object	A general term for devices, images, components, or other things placed on a sheet.
Style	Default values for each object, such as the color and shape, and the device settings. These user styles can be customized and stored on the computer.
Link group	A group for editing multiple channels of the same series in tandem.

### Files

ProVisionaire Design uses the following files.

File type	Summary
Project file (extension .pvd)	This file contains all the settings of ProVisionaire Design. Style information is also contained in project files that were saved by [Save with Style]. While ProVisionaire Design is running, backup files are saved as *.pvd in the following folder every 5 minutes. The backup file is automatically deleted when the application is closed normally. C:/Users/(user name)/Documents/Yamaha/ProVisionaire Design/Backup
Style file (extension .pvds)	This file saves styles for use with ProVisionaire Design. It contains style information that was created in another project.

In this users guide, < > indicates a key on the computer keyboard. < Shift > indicates the Shift key.

## 1.3. Operating requirements and installation

In order to connect devices to the computer and use them, download ProVisionaire Design from the "download" page of the Yamaha Pro Audio website.

<https://www.yamahaproaudio.com/>

### 1.3.1. Operating requirements

OS	Windows 11 (64bit) / Windows 10 (64bit)
CPU	Core i or better
Memory	8 GB or more
Available hard disk capacity	At least 700 MB
Display	1280×1024 (SXGA) or better
Other	Install Bonjour Print Service (Windows) when updating the PGM1 firmware or configuring the IP settings. Ethernet support is required (1000BASE-T or better).



The above operating requirements are for ProVisionaire Design version 1.1.0. The following URL provides the latest information on the current version of the software and its operating requirements.

<https://www.yamahaproaudio.com/>

Depending on the computer that you're using, the requirements might exceed those that are listed above.

### 1.3.2. Installation

Download the installers for ProVisionaire Design from the Yamaha Pro Audio website.

On the website, the links are provided in the [Product information] → [Applications] page.

<https://www.yamahaproaudio.com/>

Decompress the compressed file that you downloaded, double-click Install\_PVDesign.exe, and install the software as directed by the installer.

## 1.4. An overview of ProVisionaire Design

- Broadly speaking, ProVisionaire Design is divided into a "Project" sheet, "Tuning" sheet, and device sheet. The "Project" sheet registers devices and makes settings for them. The "Tuning" sheet enables you to set up a link group to control multiple amp channels collectively. A link group that you specify can be operated using the [Link Group Editor](#). The device sheet specifies detailed settings and control of each device.
- Parameters for the entire project can be recalled using the "[Linked Presets Manager](#)" dialog box. For details on how to store/recall for each device, refer to the page for each device.
- Default values (other than position information) for the [Properties](#) can be stored on the computer as a user style. By saving a user style, you can avoid having to change the settings each time you add a device to the project. User styles can also be transferred to another computer.
- Devices can be grouped as a [Device Group](#). Grouping multiple devices together allows unified management of their power, etc.
- By using the SOLO function in the "Tuning" sheet, you can control the audio output for each [link group](#) separately.
- When speakers are placed in the "Project" sheet and connected to a PC-series device, you can open the "[Speaker Editor](#)" to adjust the response for individual speakers, or the "[Multiple Speaker Editor](#)" to adjust the speaker parameter response for multiple speakers connected to the same power amplifier.
- When speakers are placed in the "Project" sheet and connected with a power amplifier, you can register individual speakers in a [link group](#).

## 2. Screen structure

ProVisionaire Design consists of a "menu bar," "tool bar," "Project sheet," "Tuning sheet," and "device sheet."

The "Project sheet" is a sheet for placing devices. The devices placed here are registered in the project.

The "Tuning sheet" is a sheet where you specify the EQ or levels of a device. The "Tuning" sheet is where you specify the EQ and levels for the PC series and XMV series units. Power amp channels can be grouped across multiple devices of the same series, allowing linked operation of the same types of parameters using either relative values or absolute values.

The "Device sheet" is where you can make detailed settings for each device.

Each sheet has the following areas.

Sheet		Area
"Project" sheet		"Devices" area "Network" area "Properties" area "Bird's Eye" view
"Tuning" sheet		"Components" area "Properties" area "Project Devices" area "Link Group" area "Bird's Eye" view
"Device sheet": Audio Processors	DME7	"Components" area "Parameter Sets" area "Properties" area "Parameters" area "Bird's Eye" view
	MRX7-D	"Components" area "Parameter Sets" area "Presets" area "Parameter Link Group" area "Gang Edit Group" area "Properties" area "Parameters" area "Bird's Eye" view
	MTX5-D	"Presets" area "Bird's Eye" view
	MTX3	"Presets" area "Bird's Eye" view
"Device sheet": Power Amplifiers	PC Series	"Presets" area "Bird's Eye" view
	XMV Series	"Bird's Eye" view
"Device sheet": Powered Speakers	VXL1-16P	"Bird's Eye" view

Sheet		Area
"Device sheet": Microphones	RM-CG	"Bird's Eye" view
	RM-TT	"Bird's Eye" view

## 2.1. Common to all sheets

Here we explain items that are common to all sheets.

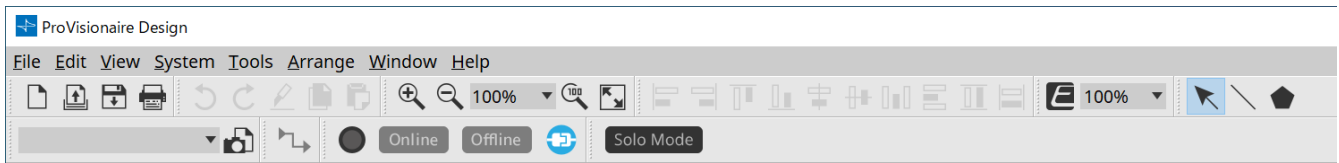

### Menu bar

File Edit View System Tools Arrange Window Help

The commands that can be executed by ProVisionaire Design can be found here, grouped by category. Click here to see a list of commands. ([Menu bars and tool bar](#))

### Tool bar

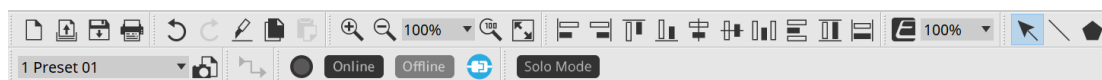

Frequently-used functions are provided here as buttons. ([Menu bars and tool bar](#))

### Bird's Eye view

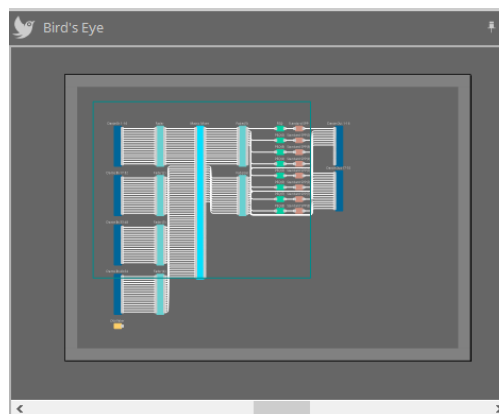

This shows an overview of the sheet. The area surrounded by a green frame is shown in the sheet. Drag the frame to move the area shown in the sheet. When the ← → icon is shown at the four corners, you can drag it to make the frame larger or smaller, and the sheet display area will change accordingly.

To zoom-in/out the Bird's Eye view itself, hold down < Ctrl > and turn the mouse wheel.

When the cursor is located at the border between the Bird's Eye view and the area above, the cursor changes shape, letting you drag to change the height of the view.







## Area





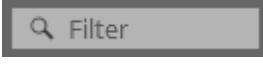

In the upper right of the area is a "☰" symbol; when you click this, the area becomes an icon and is placed at the left or right side of the screen, allowing the sheet to occupy more of the screen. When you place the cursor on the icon, the area is temporarily expanded. If you want to once again view an iconized area in its fixed position, move the cursor over the icon and click the "☰" symbol that appears.

The area contains the following buttons and edit boxes.

Button or edit box	Summary
	Expands the entire tree.
	Collapses the entire tree.
	Finds and displays the objects that meet the conditions that you entered.
	Registers the style of the selected object in the computer as a style.

## Sheet

Use the  button of the sheet to access the sheet list, and select the sheet to which you want to move. When the number of sheets increases, the   buttons appear. The  button moves one sheet to the left. The  button moves one sheet to the right. You can also use the [Close] menu, which you can access by right-clicking the sheet to close it.

When the cursor is located at the border between a sheet and the area, the cursor changes shape, letting you drag to change the width of the area.

## 2.2. "Project" sheet

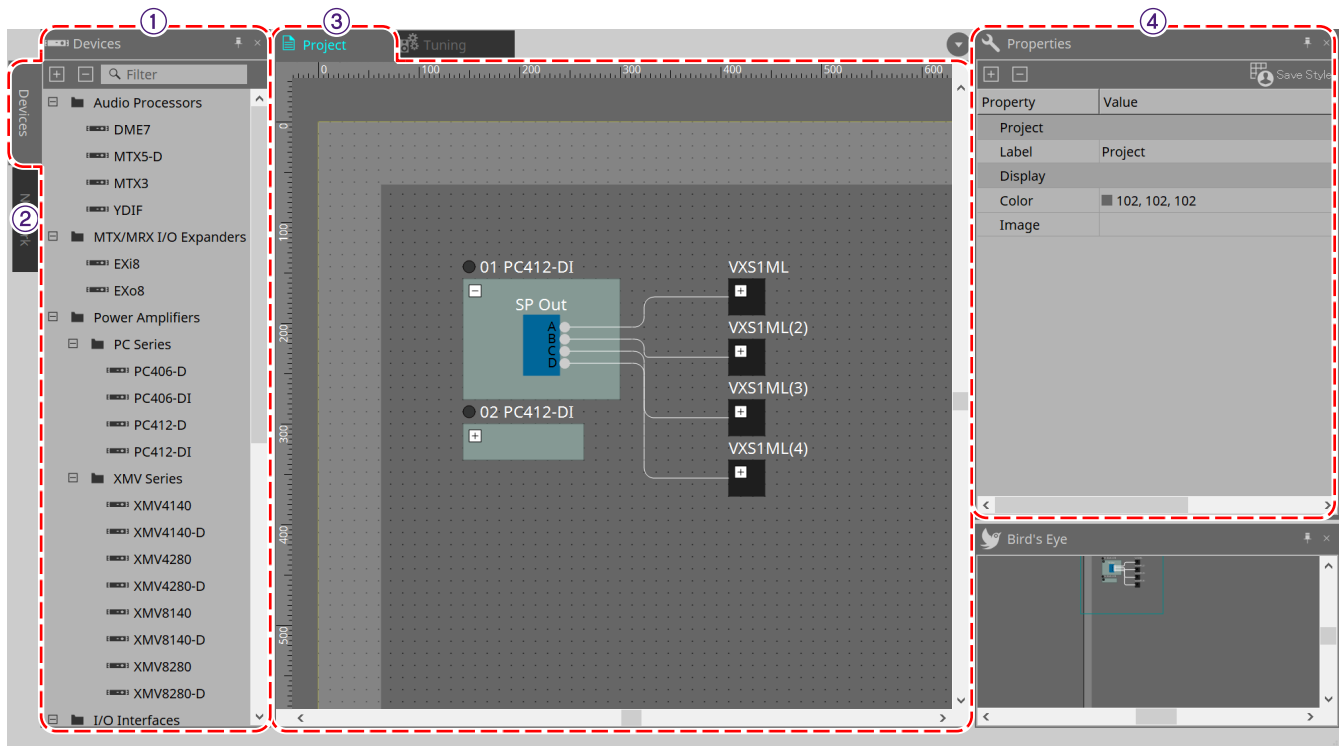

### ① "Devices" area

This lists the devices that are placed in the "Project" sheet. To register a device in the project, drag and drop the device into the "Project" sheet. ("[Devices](#)" area)

### ② "Network" area

This lists the devices detected by the computer. To register a device in the project, drag and drop the device into the "Project" sheet. ("[Network](#)" area)

### ③ "Project" sheet

In this sheet you can place devices to register them in the project, or create a connection diagram. ("[Project](#)" sheet)

Double-click a device to open the device sheet.

### ④ "Properties" area

Here you can view and edit information about the selected object. ("[Properties](#)" area)

## 2.3. Linked Presets

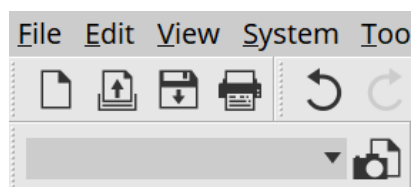

This function enables you to recall all devices added to the project collectively.

Use the "Linked Presets Manager" dialog box that appears when you click the  button. ("[Linked Presets Manager](#)" dialog box)

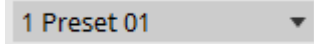
Presets for the entire project can also be recalled from the  .

## 2.4. "Tuning" sheet for PC series/XMV series only

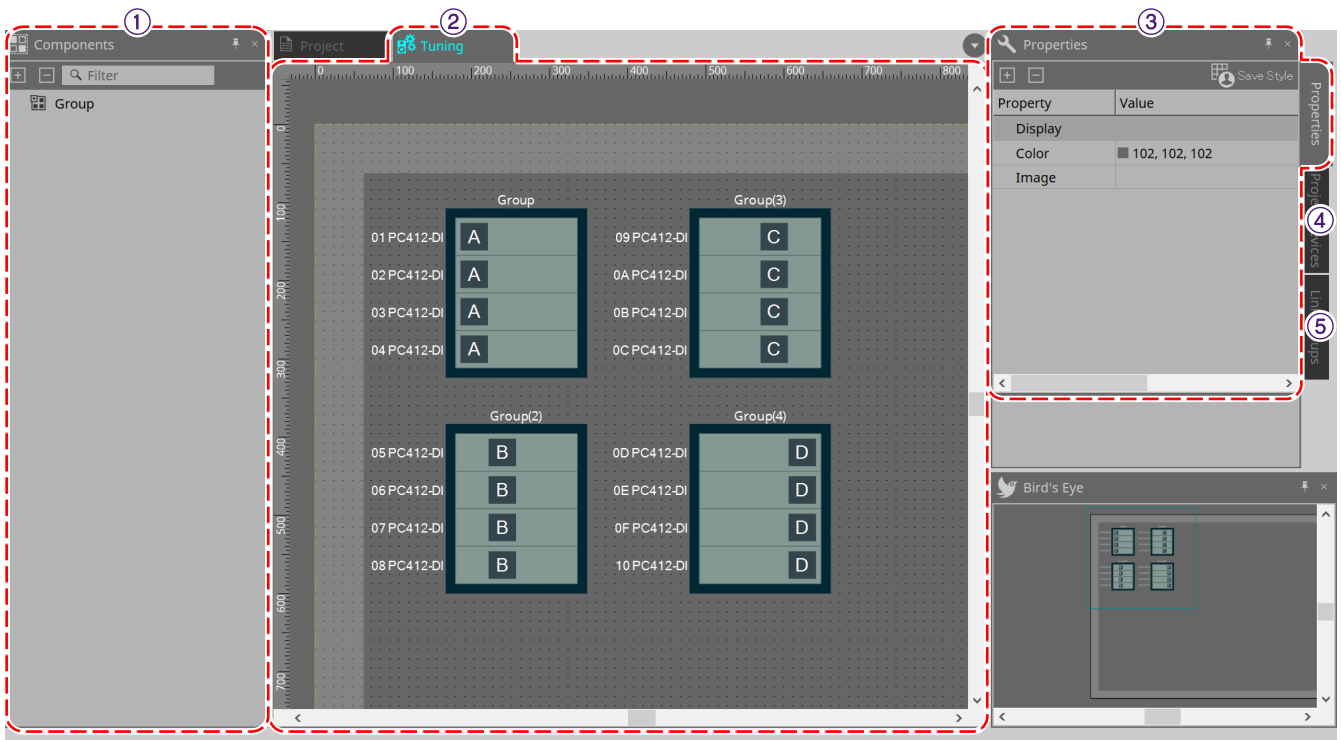

### ① "Components" area

Register a link group by dragging and dropping a "Group" component into the "Tuning" sheet.

### ② "Tuning" sheet

In this sheet you can create and edit a link group.

A link group is a function that lets you link individual channels between devices. (["Tuning" sheet](#))

### ③ "Properties" area

Here you can view and edit information about the selected object. (["Properties" area](#))

### ④ "Project Devices" area

Of the devices placed in the "Project" sheet, the devices to which link grouping is applicable are shown in the tree.

Register a device in a link group by dragging and dropping it onto the "Group" component. (["Project Devices" area](#))

### ⑤ "Link Groups" area

This shows the state of link group assignments as a tree. (["Link Groups" area](#))

## 2.5. Device sheet

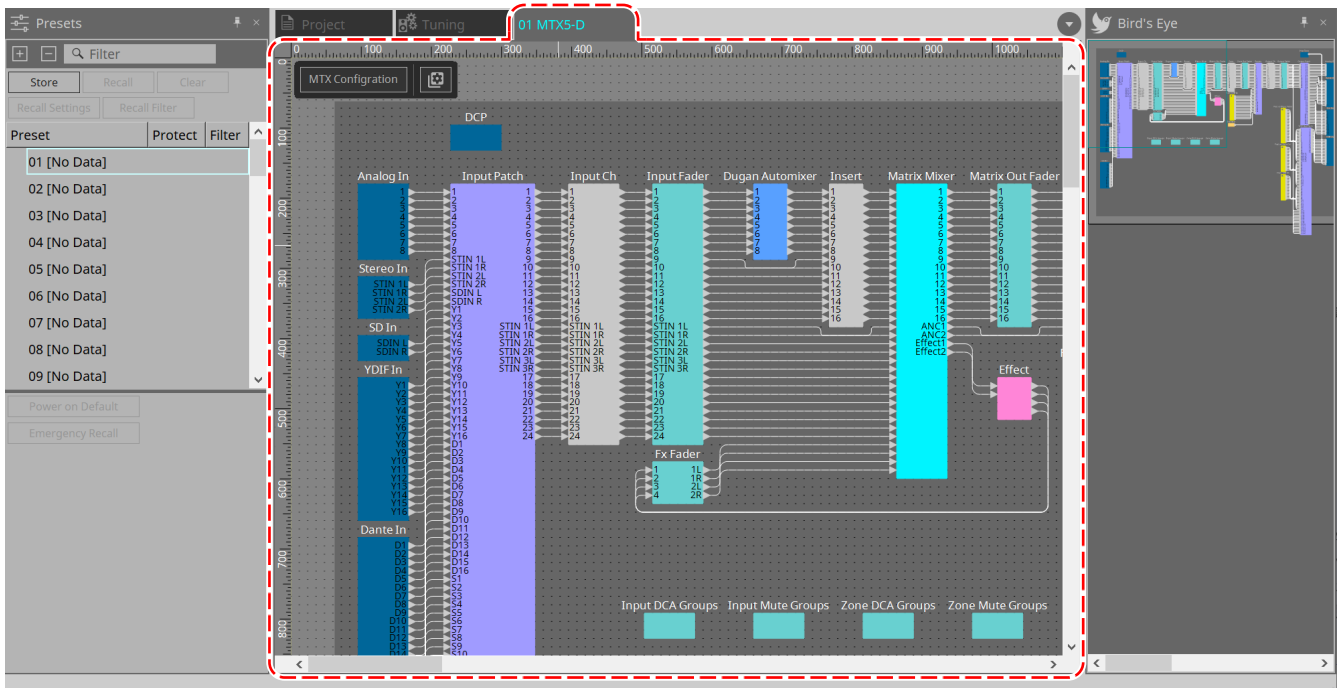

This sheet opens when you double-click a device that has been placed in the "Project" sheet. Components for the various devices are placed here. When you double-click a component, the component editor appears, allowing you to edit the parameters of the device.

For more information, refer to the section for the corresponding device.

## 3. The basics of using ProVisionaire Design

### 3.1. Connecting the devices

The connector on the device that will be used to connect to ProVisionaire Design varies depending on the device model. Refer to the connectors listed in the following table.

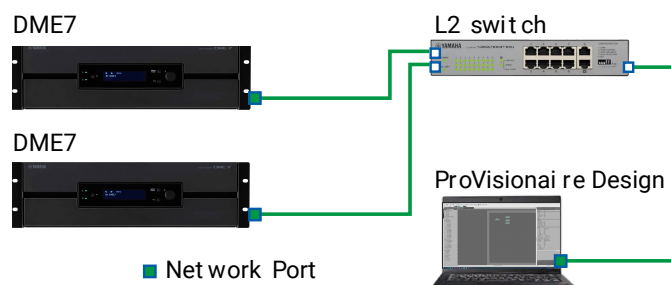

Model	Connector
DME7	Network connector
MRX7-D/MTX5-D	Dante [PRIMARY] connector
MTX3	Network connector
EXi8/EXo8	Network connector
R series/Tio series	Dante [PRIMARY] connector
PC-D/DI series	Network connector
XMV-D series	Dante [PRIMARY] connector
XMV series	Network connector
RM-CG/RM-TT	Dante/PoE connector
VXL1-16P	Dante/NETWORK connector

### 3.2. Procedure

To use ProVisionaire Design, proceed as described below, depending on whether the power amp is accessible nearby.

If you are constructing a Dante network, also install Dante Controller, and do the patching in Dante Controller.

For more about Dante Controller, refer to the links on the Yamaha Pro Audio website.

<https://www.yamahaproaudio.com/>

### 3.2.1. If you can connect the device(s) to the computer

If you are near the power amp(s), you'll start by setting up the network before you make settings. The default settings for a PC-series amp are as follows, and assume that you are constructing a redundant network.

Item	Default value
UNIT ID	1
Dante Secondary Port	Redundant *star connection
IP Setting	DHCP (if there is no DHCP server, the IP address 169.254.x.x is specified)

#### 1. Make connections.

Connect the power cords and network cables of the devices.

If you're using a daisy chain connection, change the "Dante Secondary Port" setting to [Daisy Chain].

#### 2. Turn on the power of all connected devices.

Initialize or update the firmware as needed.

If you want to use ProVisionaire Design to initialize or update the firmware, choose [System] menu → [Device Information], and perform these actions in the "Device Information" dialog box that appears.

#### 3. Start ProVisionaire Design.

The "Network Setup" dialog box will appear.

Add a check mark to the check box for the network card that will be used to communicate with the devices, and then click the [OK] button.

You can select up to two network cards at a time. In that case, set a different subnet for each network card.

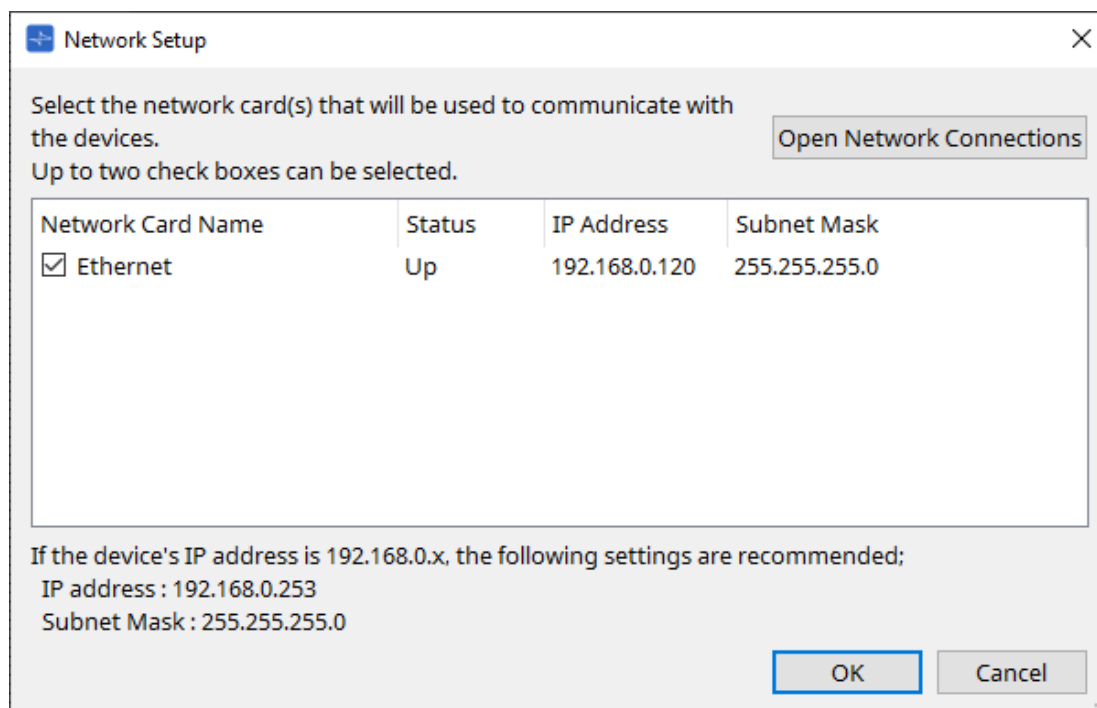

4. When the startup dialog box appears, click the [New] button.

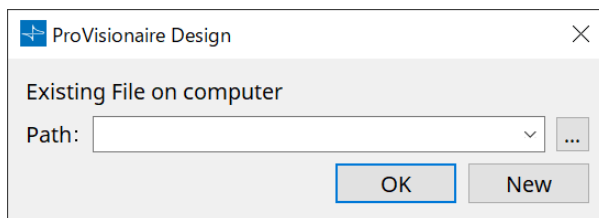

5. Verify that the devices are shown in the "Network" area.

If they are not shown, check the connections with the devices, and use the "Network Setup" dialog box to verify that the correct network card is connected to the devices.

6. In the "Network" area, click the [Unit ID] button.

The "Change Unit ID" dialog box will appear.

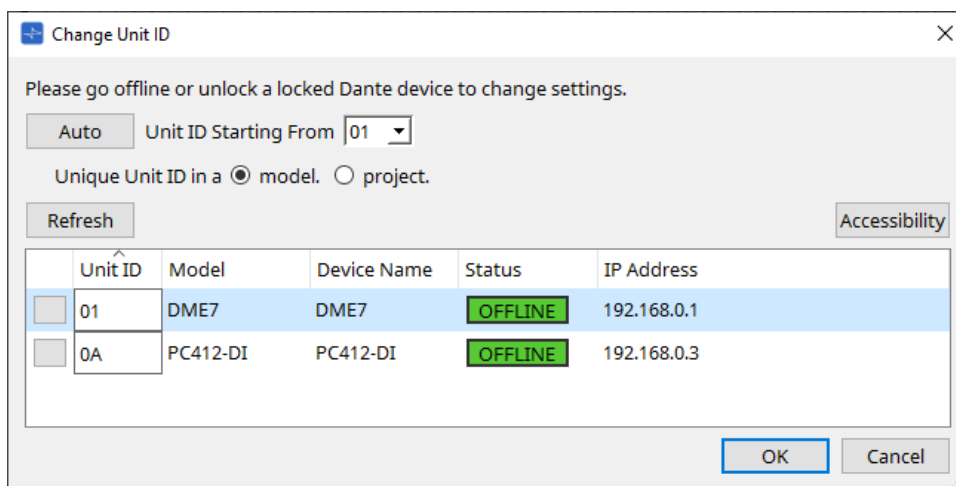

7. Click the [Auto] button.

The UNIT ID of each device is set automatically so that they do not conflict.



This operation does not apply to the MTX series or XMV series units. Use the dip switches on the rear panel to set the Unit ID.

8. Click the [OK] button.

The devices will restart, so wait until the devices amps reappear in the "Network" area.

9. Drag and drop a device from the "Network" area into the "Project" sheet.

The device is registered in the project.

If you hold down < Shift >, click the top device, and then click the bottom device, you can drag and drop all these devices in a single operation.

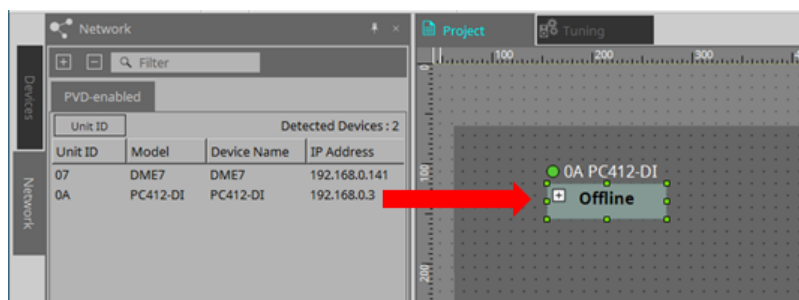

10. On the tool bar, click the [Online] button.



The "Synchronization" dialog box will appear.  
For details on synchronization, refer to "Online and synchronization".

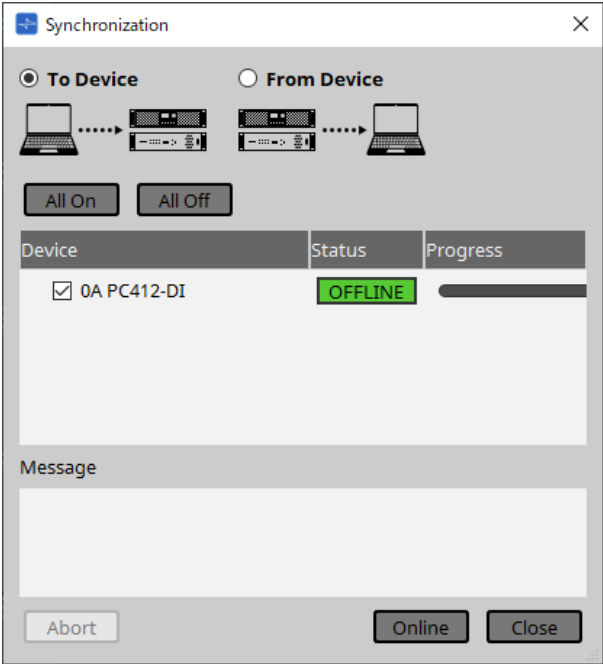

- 11. **Choose [To Device], and then click the [Online] button.**  
ProVisionaire Design's settings are sent to each device.
- 12. **Double-click a device.**  
The device sheet appears.

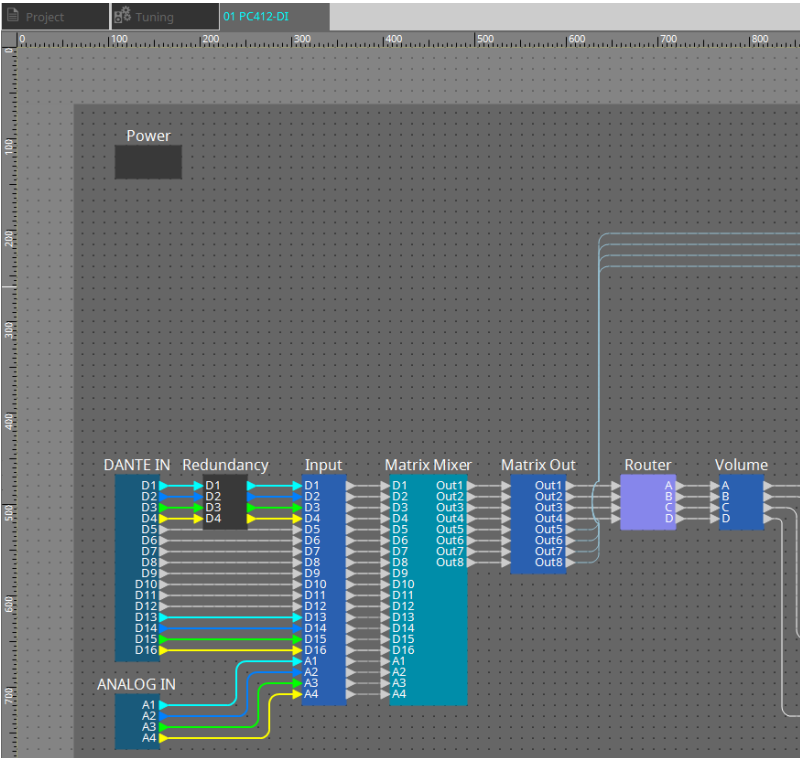



13. **Double-click the component that contains the parameter you want to edit.**  
The component editor appears.

There are two component editors in each device. One is common and the other is unique to the device. For common component editors, refer to "[ProVisionaire Design DME7 Component Guide](#)". For device-specific items, refer to the description of the "Component Editor" for each device.

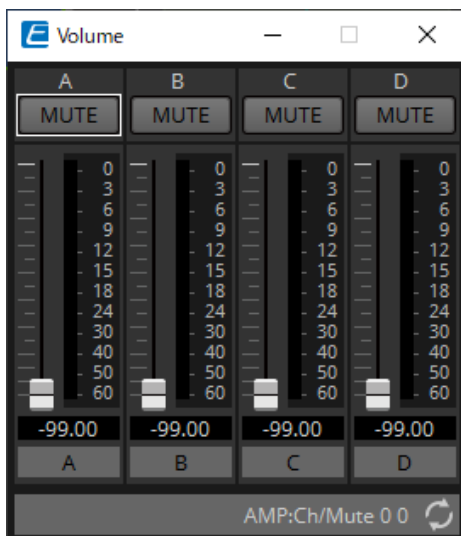

14. **Edit the parameters.**  
If you want to make the same settings multiple times, right-click and choose [Copy] in the "Project" sheet for the device that you've finished editing. On the device to which you want to apply the same settings, choose [Paste Parameters] to apply the copied settings.
15. **When you are finished editing, save the project file.**

You can save by clicking the  button.

If you want to protect the file, you can specify a PIN code in the "[Protect File](#)" dialog box which you can open from the [File] menu.



With the DME7, saving the project file while working online will save the file not only on the computer but also on the device.  
For more information, refer to the "[File Storage](#)" dialog box.

### 3.2.2. If you cannot connect the device(s) to the computer

This method lets you virtually place power amps, and then synchronize with the power amps later.

1. **Start ProVisionaire Design.**

The "Network Setup" dialog box will appear.

Since you will be working offline, click the [Cancel] button in this case.

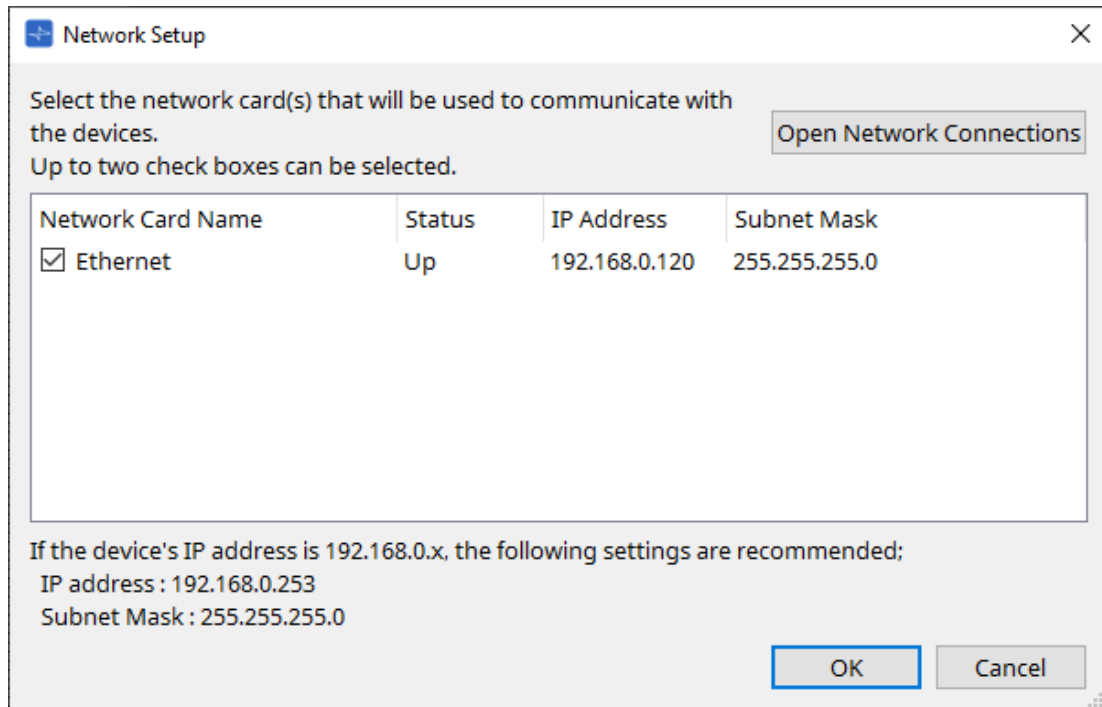

2. **When the startup dialog box appears, click the [New] button to create a new project file.**

If you want to edit a project file, click the [...] button, select the project file, and click the [OK] button.

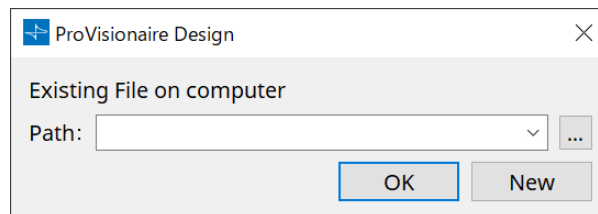

3. **Drag and drop a device from the "Devices" area into the "Project" sheet.**

The device is registered in the project.

Register the number of devices that you require.

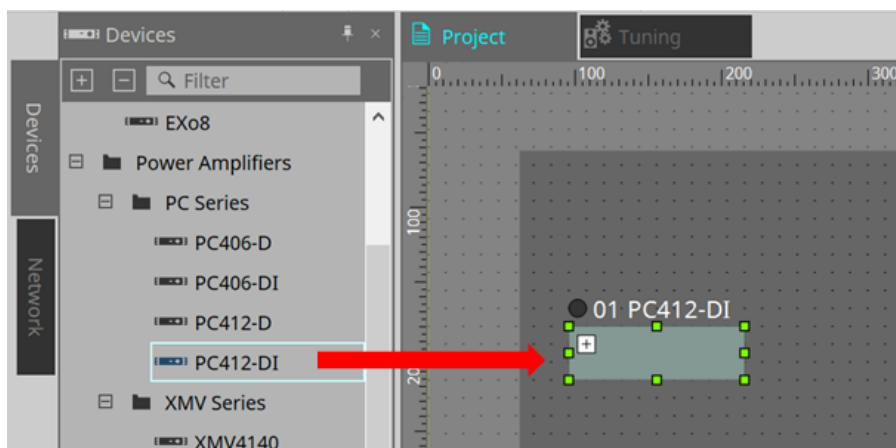

4. **Double-click a device.**  
The device sheet appears.

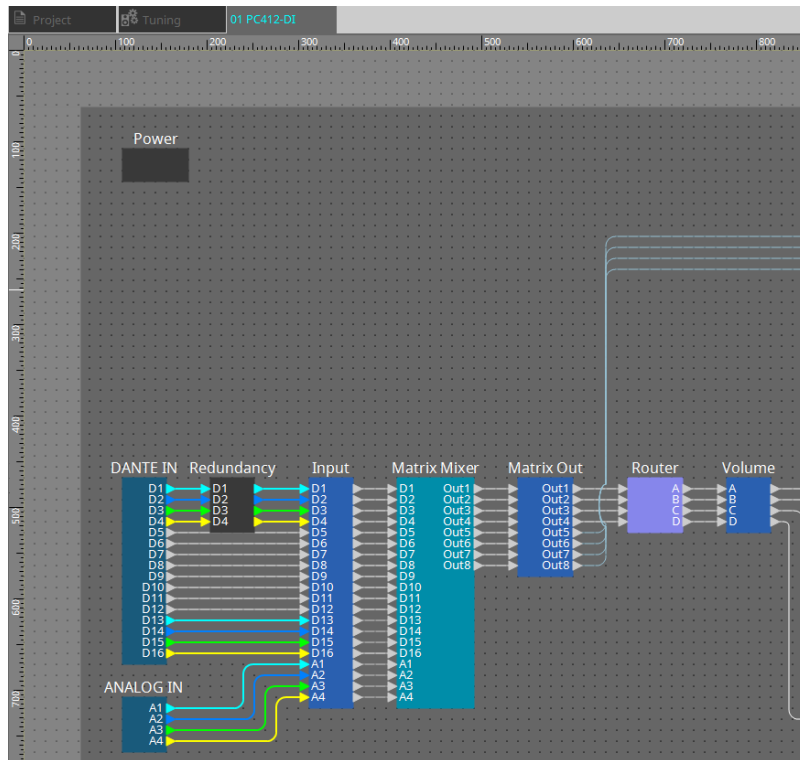

5. **Double-click the component that contains the parameter you want to edit.**  
The component editor appears.  
There are two component editors in each device. One is common and the other is unique to the device.  
For common component editors, refer to "[ProVisionaire Design DME7 Component Guide](#)".  
For device-specific items, refer to the description of the "Component Editor" for each device.

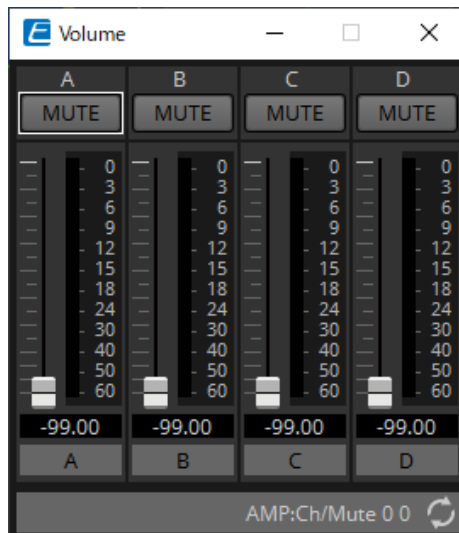

6. **Edit the parameters.**
7. **Save the project.**  
You can save by clicking the  button on the toolbar.
8. **Make settings for the device's UNIT ID and Dante [SECONDARY] port.**  
For details on making these settings, refer to the Owner's Manual of each device.

9. **Make connections.**  
Connect the power cords and network cables of the actual devices.
10. **Turn on the power of all connected devices.**  
Initialize or update the firmware as needed.  
For details on initialization or updating the firmware, refer to the owner's manual of each device.
11. **From the [System] menu on the menu bar, open "Network Setup."**  
The "Network Setup" dialog box will appear.
12. **Select the network card that will be used for communication with the devices, and click the [OK] button.**

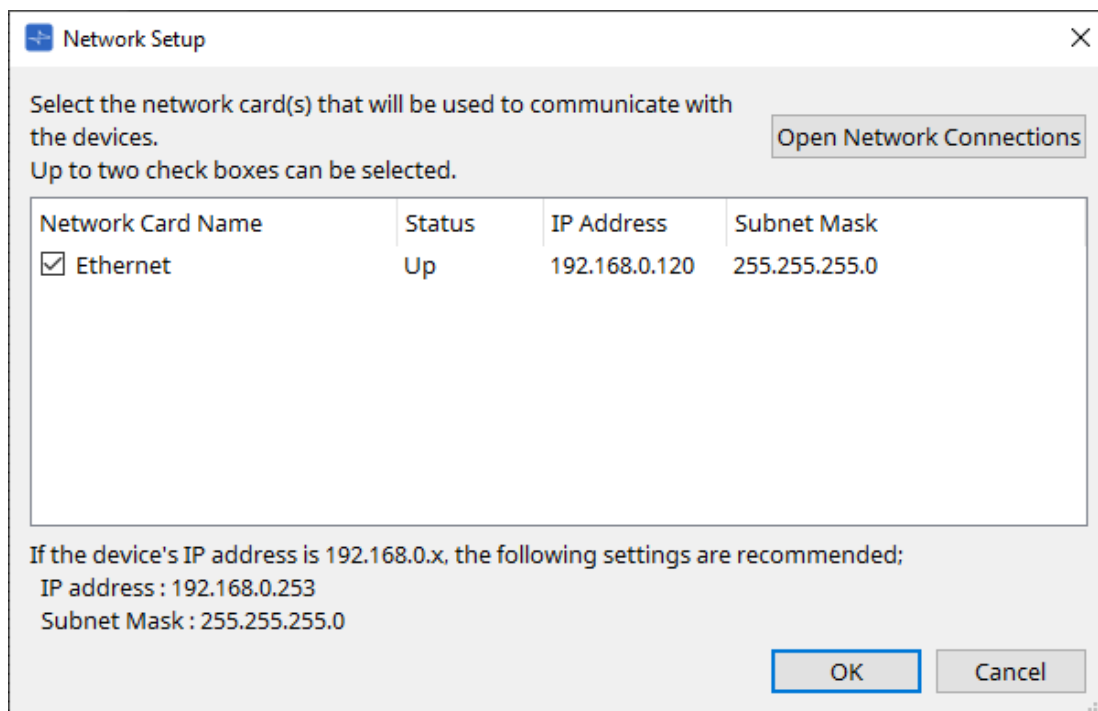

13. **The UNIT ID specified for the devices in the "Project" sheet is applied to the devices.**  
You can use the following methods to change the UNIT ID of a device.
  - Drag and drop a device from the "Network" area onto the "Project" sheet.
  - In the "Network" area, click the [Unit ID] button; then while clicking the Identify button in the "Change Unit ID" dialog box to identify the specific unit, change the UNIT ID manually.
  - Change the Unit ID using the device. Refer to the Owner's Manual for the corresponding device.



When you change the UNIT ID, the device restarts.

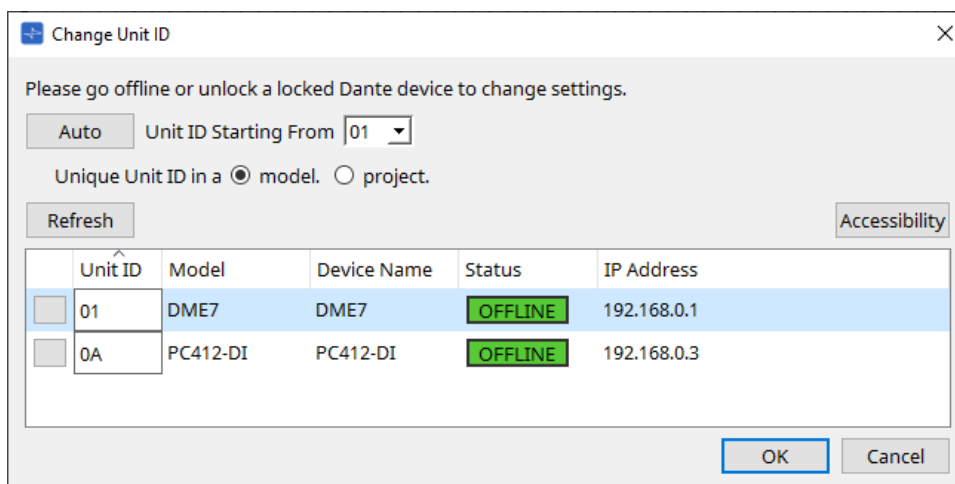

14. **On the tool bar, click the [Online] button.**  
The "Synchronization" dialog box will appear.

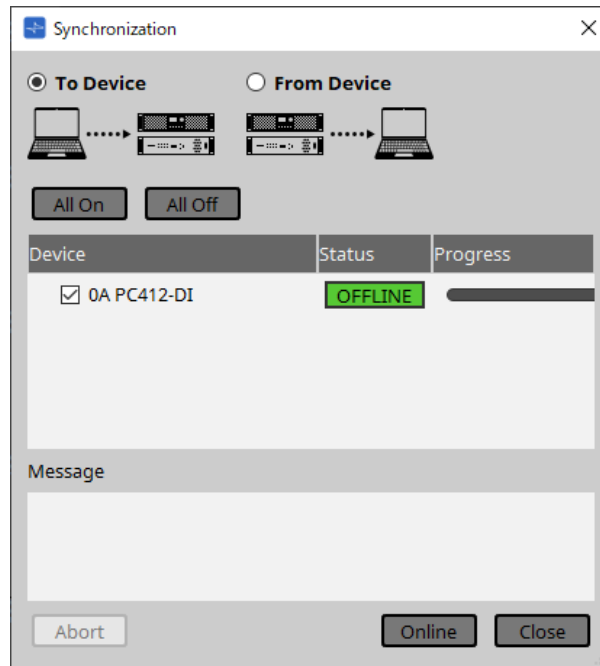

15. **Choose [To Device], and then click the [Online] button.**  
ProVisionaire Design's settings are sent to each device.
16. **Use ProVisionaire Design to edit the parameters.**
17. **When you are finished editing, save the project file by overwriting.**





## 4. Menu bars and toolbar

The menu bar contains the commands that can be executed by ProVisionaire Design, grouped by category.

Click [here](#) to see a list of commands.





Commands frequently used in ProVisionaire Design, such as "Print" and "Align Left Side," are provided as buttons in the toolbar.

### 4.1. [File] menu

Command	Toolbar button	Summary	Dialog box that appears
[New]		Creates a new project file. This command is not available while online.	---
[Open]		Opens a saved project file. This command is not available while online. When you open a project file for which a PIN code has been specified, the "Security" dialog box appears.	---
[Go Online - From Devices]	---	Applies the data from the devices on the network to the project file.	<a href="#">"Go Online - From Devices" dialog box</a>
[Save]		Saves the project file (overwriting the previous version of the file).	---
[Save As]	---	Saves the project file as a different file.	"Save File" dialog box
[Save with Style]	---	Saves the project file including the user style. Even if this project file is opened on another computer, the user style is not automatically imported. If you want to import it, open the project file and then execute [Import Style from Project File].	"Save File" dialog box
[Export Style]	---	Allows a user style saved on the computer to be exported as a file (filename extension .pvds).	"Export Style" dialog box
[Import Style]	---	Imports an exported user style back into the computer.	"Import Style" dialog box
[Import Style from Project File]	---	From a project file that includes the user style, imports the user style into the computer.	---
[Reset Style to Default]	---	Initializes the user style to the state immediately after installation.	---
[Protect File]	---	Protects the project file by assigning it a PIN code. When you open a protected file, you will be asked to enter the PIN code.	<a href="#">"Protect File" dialog box</a>
[Project Information]	---	Allows you to include a memo in the project file to record inventory information or contact information.	<a href="#">"Project Information" dialog box</a>
[Print]		Prints a scene and makes print-related settings.	<a href="#">"Print" dialog box</a>

Command	Toolbar button	Summary	Dialog box that appears
[File Storage]	---	Allows you to specify the DME7 storage to which the project file will automatically be saved.	"File Storage" dialog box
[Recent Open File]	---	Lists up to five recently used project files, allowing you to open them. This command is not available while online.	---
[Exit]	---	Exits ProVisionaire Design. This command is not available while online.	---

## 4.2. [Edit] menu





Command	Toolbar button	Summary	Dialog box that appears
[Undo]		Cancels the preceding operation. *1	---
[Redo]		Re-executes the operation that was canceled by [Undo]. *1	---
[Cut]		Moves the selected item to the copy buffer.	---
[Copy]		Copies the selected item to the copy buffer.	---
[Paste]		Pastes the item from the copy buffer to the selected location.	---
[Paste Parameters]	---	Overwrites (copies) the parameters of the component in the copy buffer to the selected component. You can also copy and paste parameters between devices.	---
[Paste to Device Group]	---	Copies the device from the copy buffer to a device group.	---
[Delete]	---	Deletes the selected object.	---
[Duplicate]	---	Duplicates the selected object.	---

Command	Toolbar button	Summary	Dialog box that appears
[Select All]	---	[All] Selects all objects in the "Project" sheet. If you want to select the contents of a device group, select the device group and then choose [All].	---
	---	[All Components] Selects all components in the "Device" sheet.	---
	---	[All Devices] Selects all devices in the "Project" sheet. If you want to select the devices in a device group, select the device group and then choose [All Devices].	---
	---	[All Wires] Selects all wires in the "Project" sheet. If you want to select the wires in a device group, select the device group and then choose [All Wires].	---
	---	[All Graphics] Selects all graphics in the "Project" sheet. If you want to select the graphics in a device group, select the device group and then choose [All Graphics].	---
	---	[All Link Groups] Selects all link groups in the "Tuning" sheet.	---
[Create Device Group]	---	Groups the selected objects in the "Project" sheet as a device group.	---
[Unpack Device Group]	---	Unpacks the objects in the selected device group onto the "Project" sheet.	---
[Unbundle Wires]	---	Displays the wires connected to the selected component or User Defined Block spaced apart at equal intervals.	For more information, refer to the section for the DME7.
[Bundle Wires]	---	Displays the wires connected to the selected component or User Defined Block overlaid together.	For more information, refer to the section for the DME7.

\*1. In the [Properties] area, you can specify the operation that the [Undo]/[Redo] command will affect: either placing/moving/deleting an object, or creating/deleting a wire between devices.



### 4.3. [View] menu

Command	Toolbar button	Summary	Dialog box that appears
Area display switch check box	---	Add a check mark to the check box to display the corresponding area. The contents of the displayed area vary depending on the sheet and device.	---
[Zoom In]		Magnifies the display within the sheet.	---
[Zoom Out]		Shrinks the display within the sheet.	---
[Zoom to 100%]		Sets the display zoom within the sheet to 100%.	---
[Zoom to Fit]		Adjusts the magnification so that all placed objects are visible in the sheet.	---
[Editor Magnification]		Adjusts the magnification ratio for Component Editor.	---
[Print Area]	---	On the sheet, shows the paper size specified in the "Print" dialog box. The (x,y) = (0,0) of the sheet is the top left of the paper.	---

### 4.4. [System] menu



Command	Toolbar button	Summary	Dialog box that appears
[Network Setup]	---	Selects the computer's network adapter that will be used to communicate with the devices. You can also change the IP address of the network adapter.	<a href="#">"Network Setup" dialog box</a>
[IP Settings]	---	Lists the devices on the network, allowing you to change their IP address.	<a href="#">"IP Settings" dialog box</a>
[Match Device by IP Address]	---	Makes settings so that ProVisionaire Design searches for devices by their IP address. Make this setting if the computer is on a different subnet than the devices.	<a href="#">"Match Devices by IP Address" dialog box</a>
[Device Information]	---	Lists the devices on the network, allowing you to update their firmware, or initialize or restart them.	<a href="#">"Device Information" dialog box</a>
[Word Clock]	---	Specifies the word clock for the device.	<a href="#">"Word Clock" dialog box</a>
[Protect Devices]	---	Specifies the Administrator PIN for the device to prevent unintended modifications.	<a href="#">"Protect Devices" dialog box</a>
[Clock]	---	Regardless of the online/offline state, the time and date will be updated for all devices connected to the same network.	<a href="#">"Clock" dialog box</a>
[Daylight Saving Time]	---	Regardless of the online/offline state, the daylight saving time setting is specified for all devices connected to the same network.	<a href="#">"Daylight Saving Time" dialog box</a>







Command	Toolbar button	Summary	Dialog box that appears
[GPI Calibration]	---	Calibrates the input voltage detection range for the [GPI] connector of the devices. (Available only when online.)	"GPI Calibration" dialog box
[Get Log from Devices]	---	Obtains the log from the MTX series or XMV series units.	"Get Log from Devices" dialog box
[Show Alert Popup]	---	Specifies whether or not the popup window will appear in ProVisionaire Design when an alert appears on the device.	---
[RM Series Settings]	---	<p>[Sign up] Specifies the initial password for the RM-CG or RM-TT.</p> <p>[Login] Logs in to the RM-CG or RM-TT for which the password has already been specified. You need to log in to configure the devices in ProVisionaire Design.</p> <p>[Password Settings] Enables you to change the password for the RM-CG or RM-TT.</p> <p>[Enable SCP remote control access] Enables or disables control of the RM-CG or RM-TT via the external SCP controller.</p>	<p>"Sign up" dialog box</p> <p>"Log In" dialog box</p> <p>"Password Settings" dialog box</p> <p>"Enable SCP remote control access" dialog box</p>

## 4.5. [Tools] menu

Command	Toolbar button	Summary	Dialog box that appears
[Trace Signal Path]		If you select a port or wire while this command is turned on (checked), the signal path will be traced starting from the selected point toward the output and input.	---
[Duplicate Port Label]	---	If you create a wire connection between ports while this command is turned on (checked), the name of the originating port will be copied to the destination port.	---

## 4.6. [Arrange] menu

Command	Toolbar button	Summary	Dialog box that appears
[Align Left Sides]		Aligns the left edge to the left-most of the multiple selected objects.	---
[Align Right Sides]		Aligns the right edge to the right-most of the multiple selected objects.	---
[Align Tops]		Aligns the top edge to the highest of the multiple selected objects.	---

Command	Toolbar button	Summary	Dialog box that appears
[Align Bottoms]		Aligns the bottom edge to the lowest of the multiple selected objects.	---
[Align Horizontal Centers]		Aligns the center of the object to the horizontal mid-point of the multiple selected objects.	---
[Align Vertical Centers]		Aligns the center of the object to the vertical mid-point of the multiple selected objects.	---
[Distribute Horizontally]		Spaces the selected objects evenly in the horizontal direction.	---
[Distribute Vertically]		Spaces the selected objects evenly in the vertical direction.	---
[Same Horizontally]		Aligns the height of the selected objects.	---
[Same Widths]		Aligns the width of the selected objects.	---
[Bring to Front]	---	Moves the selected object to the foreground.	---
[Send to Back]	---	Moves the selected object to the farthest background.	---

## 4.7. [Window] menu









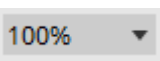

Command	Toolbar button	Summary	Dialog box that appears
[Close All Editor Windows]	---	Closes all component editor and parameter setting windows.	---
[Show All Editor Windows]	---	Shows all component editor and parameter setting windows in the foreground.	---
[Hide All Editor Windows]	---	Hides all component editor and parameter setting windows.	---



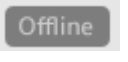

## 4.8. [Help] menu

Command	Toolbar button	Summary	Dialog box that appears
[Shortcut Keys]	---	Shows a list of shortcut keys.	"Shortcut Keys" window

## 4.9. Buttons only on the toolbar

The following buttons do not have corresponding menu commands.

Button	Summary
	Indicates the current magnification within the sheet. Click ▼ to change the magnification. You can click the numerical indication and directly enter a value. Shrinks the display within the sheet.
	Puts the mouse cursor in a mode for selecting or editing an object.
	Puts the mouse cursor in a mode for drawing lines in the "Project" sheet.
	Puts the mouse cursor in a mode for drawing polygons in the "Project" sheet. When drawing a polygon, click to specify each corner. Double-click when you are finished drawing.
	The stored Linked Presets are displayed as shown at left. (Empty Linked Presets device presets are not shown.) The Linked Presets you select here will be recalled. When you click the ▼ at the right, a pulldown menu appears, allowing you to recall the selected Linked Presets.
	Opens the <a href="#">"Linked Presets Manager" dialog box</a> .
	This is lit if the devices and the computer are online. The color of the indicator will change according to the status. Blue: When all placed devices are offline Yellow: When at least one of the placed devices is offline Unlit: When all devices are offline
	When you click this, the <a href="#">"Synchronization" dialog box</a> (synchronization method selection) appears, allowing you to synchronize the device with ProVisionaire Design.   If the placed device is not actually connected to the network, the [Online] button will not be available.
	Click this to open the <a href="#">"Offline" dialog box</a> .   If the placed device is not actually connected to the network, the [Offline] button will not be available.

Button	Summary
	<p>Switches the status of the connection between ProVisionaire Design and the network. Even in the offline state, if this status is connected, ProVisionaire Design will send data to the network, for example to search for devices. Set this to the unconnected status if you don't want unnecessary data to be transmitted, for example if you're connected to an office LAN.</p> <p> Connected.</p> <p> Disconnected.</p>
	<p>When online with the device, the link group editor's [SOLO] button is enabled.</p>

## 5. Shortcut keys

Here are the shortcut keys that you can use in ProVisionaire Design.

### Designs

Key combinations	Operation
< F5 >key	Execute [ Online ].
< Ctrl >key + < F5 >key	Execute [ Offline ].
Mouse wheel	Modify the value of a fader, knob, or numeric box.
Whilst holding down < Alt >key + click a parameter in Component Editor.	Set the parameter to nominal value.
< Alt >key + < F4 >key	Opens the component editor that is in the foreground.

### Sheet Operations

Key combinations	Operation
< ↑ >key/< Ctrl >key + < ↑ >key	Scrolls the sheet upward. If an object is selected, this moves the selected object upward. Components of a device whose configuration is fixed cannot be moved.
< ↓ >key/< Ctrl >key + < ↓ >key	Scrolls the sheet downward. If an object is selected, this moves the selected object downward. Components of a device whose configuration is fixed cannot be moved.
< ← >key/< Ctrl key> + < ← >key	Scrolls the sheet to the left. If an object is selected, this moves the selected object to the left. Components of a device whose configuration is fixed cannot be moved.
< → >key/< Ctrl >key + < → >key	Scrolls the sheet to the right. If an object is selected, this moves the selected object to the right. Components of a device whose configuration is fixed cannot be moved.
< Page Up >key	Scrolls the sheet upward.
< Page Down >key	Scrolls the sheet downward.
< Home >key	Moves to the left-most object.
< End >key	Moves to the right-most object.
< Ctrl >key + < Home >key	Moves to the object in the upper left corner.
< Ctrl >key + < End >key	Moves to the object in the lower right corner.
Mouse wheel	Scrolls the sheet upward or downward.
< Shift >key + mouse wheel	Scrolls the sheet to the left or right.
< Ctrl >key + mouse wheel	Zooms the sheet in/out.
< Alt >key + < F3 >key	Shows a list of sheets.

## Editing

Key combinations	Operation
Double-click on any object in "Components".	Initiates Stamp mode. Stamp mode is a function that places a component on the sheet each time you click.
< Esc >key	Discontinue Stamp Mode and in-progress edits.
Click on existing object in Design Sheet whilst holding down < Ctrl > key, then drag and drop from that item.	Duplicate a object.
Whilst holding down < Ctrl > key, drag and drop component(s) from Design Sheet or parameter from component editor window.	Assign item(s) to the following windows -Parameter sets -GPI dialog box -Remote Control Setup List dialog box -DCP Components
Drag and drop component(s) or parameter(s) from "Parameters".	Assign item(s) to the following windows -Parameter sets -GPI dialog box -Remote Control Setup List dialog box -DCP Components
Alphanumeric keys	-Design Sheet Select the component(s) with label beginning with matching character. If more than one component, step through them.  -Components, Parameter Sets, Parameters Select the componenUParameter/Group with labelb eginning with matching character. If more than one component, step through them
< Ctrl > key+ click	Simultaneously select or deselect multiple objects.
< Shift > key+ click	Simultaneously select or deselect multiple objects.
Drag the mouse cursor.	Select objects that are fully contained inside the rectangular area.
While holding down the < Ctrl > key, drag the mouse cursor.	Select objects that are partially contained inside the rectangular target area.
While holding down the < Shift > key, drag the mouse cursor.	Select component input ports that are fully inside the rectangular target area.
While holding down the < Alt > key, drag the mouse cursor.	Select component output ports that are fuly inside the rectangular target area.
While holding down the < Shift > key+ < Alt > key, drag the mouse cursor.	Select the component input and output ports that are fully inside the rectangular target area.
Select and drag from the origin port on a component to destination port on another component.	Create a wire connection between component ports. Pressing the space key while dragging opens the Transmitter or Reciever Form dialog window.

Key combinations	Operation
Select wires and press < Space > key.	Connect the wires to the Transmitter and Reciever components.
Select and drag from multiple origin ports of a component to destination port on another component.	Create multiple wire connections between component port
Select output ports of audio components when the Probe Monitor component is ON.	Sets Monitor Probe 1.
Hold down the < Shift > key and select the output port of the audio component when the Probe Monitor component is On.	Sets Monitor Probe 2.
Select the input port of the audio component when the Probe Monitor component is On.	Sets the oscillator probe.



## 6. List of alerts

If the devices malfunction, an alert message will appear on the display. If an alert is already displayed when a higher level malfunction occurs, the alert for the higher level malfunction will appear. For details on each alert, please refer to the links below.

### 6.1. Power amplifiers

[PC series](#)

[XMV series](#)

### 6.2. Processor

[DME7](#)

[MRX7-D](#)

[MTX5-D,MTX3](#)

## 7. "Project" sheet

When you open the "Project" sheet, the "Devices" area, "Network" area, "Project" sheet, "Properties" area, and "Bird's Eye" view appear.

"Bird's Eye" view shows the entirety of the "Project" sheet.

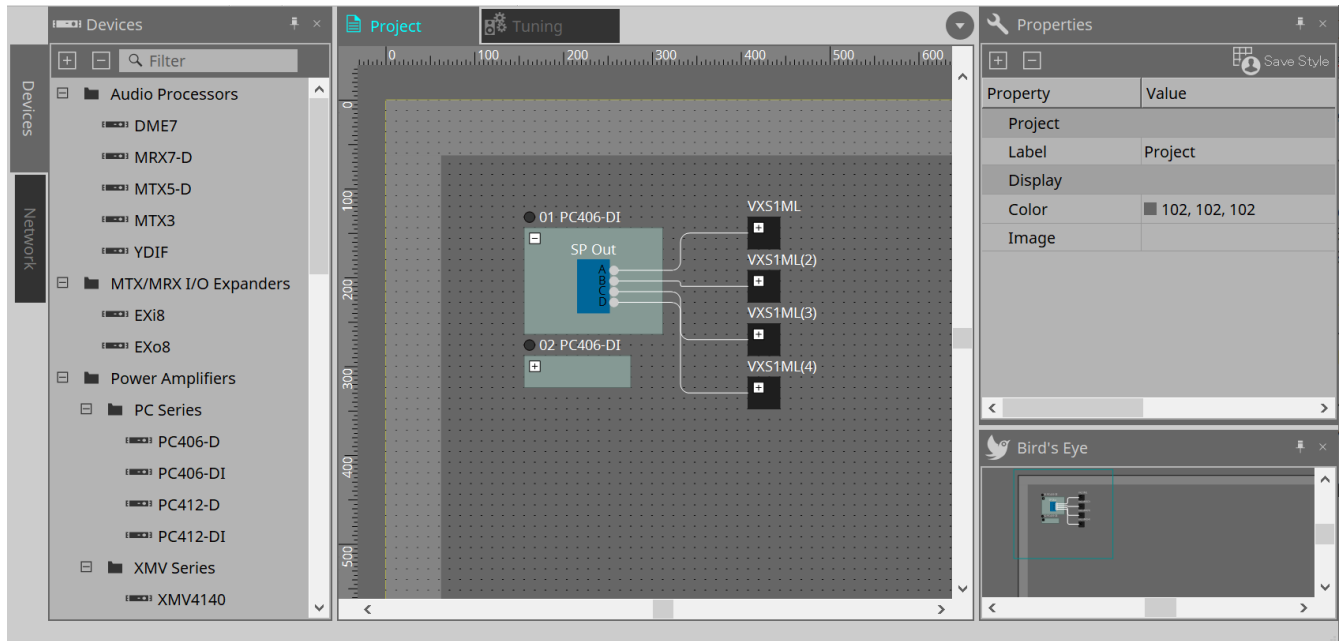

### 7.1. "Project" sheet

You can place devices in this sheet. The devices placed here are registered in the project. Basic settings for a registered device are made in the "Properties" area.

### 7.2. "Devices" area

To place a device in the "Project" sheet as a virtual device, drag and drop the device from this area.

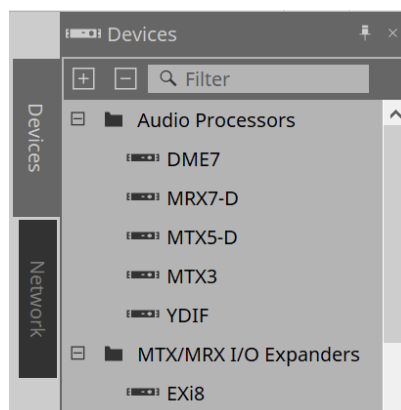

For more information on the YDIF, refer to the section for the "YDIF".

## 7.3. "Network" area

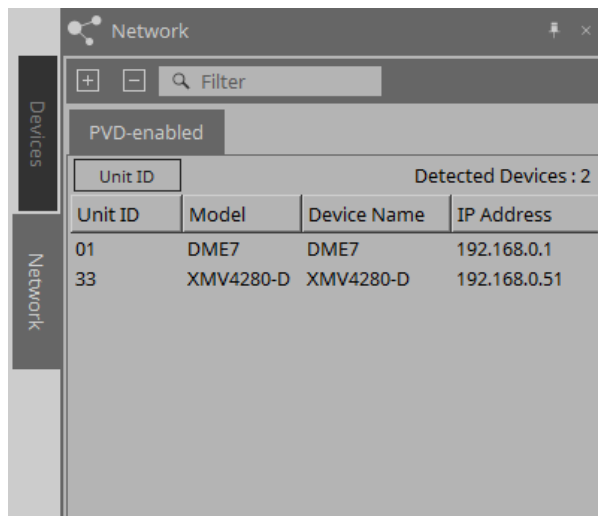

The devices that are on the same network as the computer are detected and shown here.

A device shown here can be registered in the project by dragging and dropping it into the "Project" sheet. When you click the [Unit ID] button, the "Change Unit ID" dialog box appears.



### RM-CG / RM-TT

To control these devices, you must log in to ProVisionaire Design.

If the initial password has not been specified, the  icon will appear. If the initial password has been specified but you have not logged in, the  icon will appear.

You can control these devices via "RM Settings," which you can access from the context menu or [System] menu.

### 7.3.1. "Change Unit ID" dialog box

In this dialog box you can change the UNIT ID of the device. When you change the UNIT ID, that device will restart, so it will temporarily disappear from the "Network" area.

You can't change the UNIT ID of a device that is in the online state.

Supported models: DME7, PC series, RM-CG, RM-TT, VXL1-16P



This operation does not apply to the MTX series or XMV series units. Use the dip switches on the rear panel to set the Unit ID.

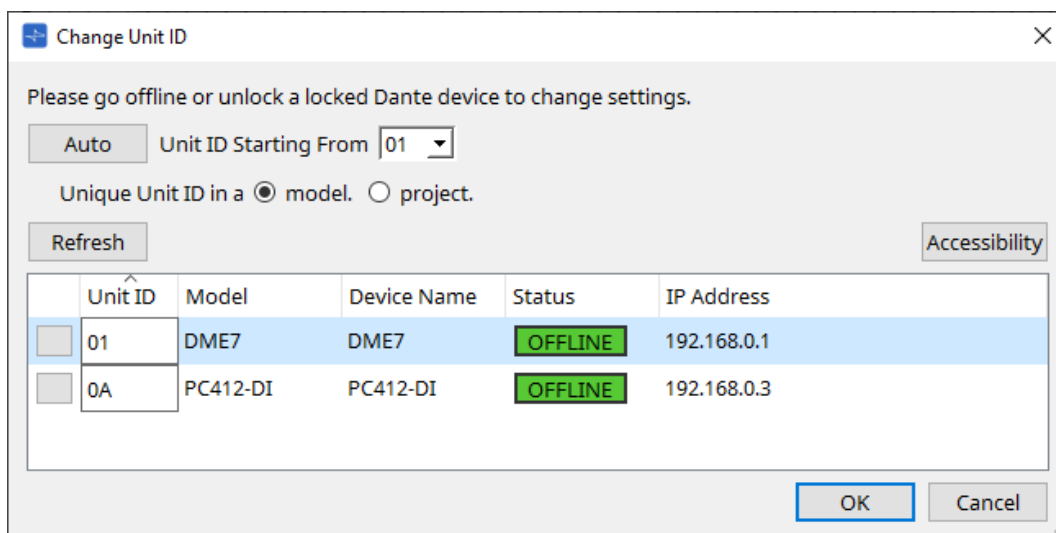

- 
- **[Auto] button**  
Automatically assigns a UNIT ID to each device, starting with the number selected in the [Unit ID Starting From] list box.
  - **[Unique Unit ID in a model/project] option buttons**  
Specify whether the UNIT ID assignments that are made when you press the [Auto] button are unique for each model or unique for each project.
  - **[Refresh] button**  
Updates the device list located below the button.
  - **[Accessibility] button**  
Opens a supplementary "Unit ID" window that lets you change the UNIT ID of the currently selected device. The "Unit ID" window also opens when you right-click somewhere other than the Identify button or the [Unit ID] text box in the device list below.
  - **Device list**  
The devices that are on the same network as the computer are detected and shown here.
    - **Identify button**  
When you press this button located at the left of the UNIT ID, the indicators of the corresponding device will flash for several seconds.
    - **[Unit ID] text box**  
Specifies the UNIT ID of the corresponding device.
    - **[Model]/[Device Name]/[Status]/[IP Address]**  
Show information for the device. You can click to sort the list.

■ "Unit ID" dialog box

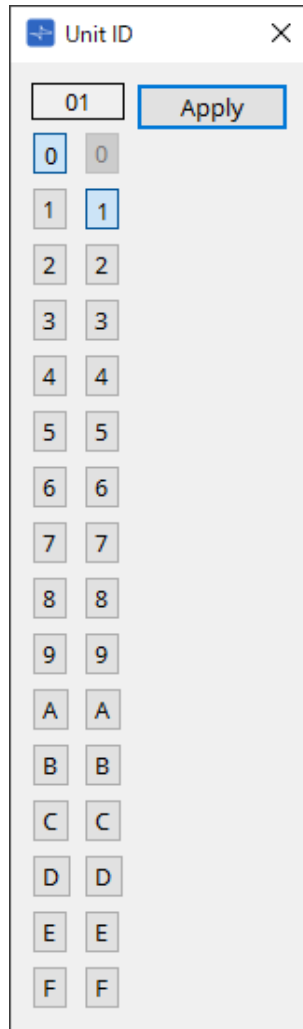

Click the buttons to display the Unit ID at the top.  
You can change the Unit ID for one or more devices.



If you select "0" for the higher digit while the lower digit has been set to "0," the higher digit will automatically be set to "1."

• **[Apply] button**

Applies the Unit ID to the currently-selected device.

## 7.4. "Properties" area

Here you can view and edit information about the sheet or object.

For details on items related to the settings of a device, or on items that appear in the dialog box when you click, refer to the section on each device.

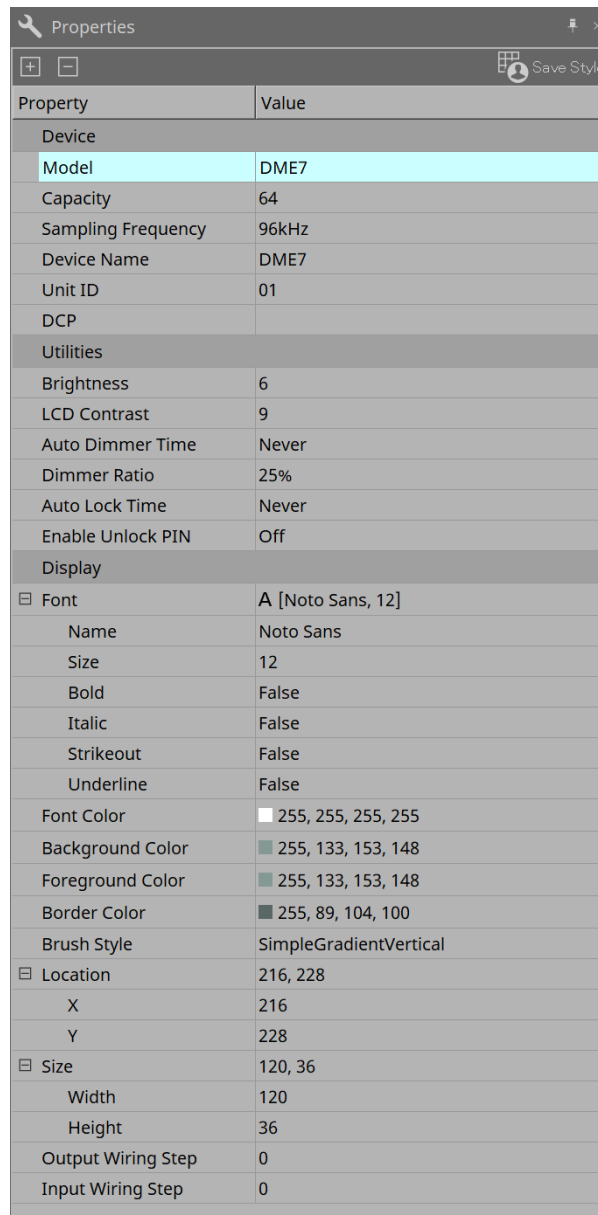

Property	Value
<b>Device</b>	
Model	DME7
Capacity	64
Sampling Frequency	96kHz
Device Name	DME7
Unit ID	01
DCP	
<b>Utilities</b>	
Brightness	6
LCD Contrast	9
Auto Dimmer Time	Never
Dimmer Ratio	25%
Auto Lock Time	Never
Enable Unlock PIN	Off
<b>Display</b>	
Font	A [Noto Sans, 12]
Name	Noto Sans
Size	12
Bold	False
Italic	False
Strikeout	False
Underline	False
Font Color	255, 255, 255, 255
Background Color	255, 133, 153, 148
Foreground Color	255, 133, 153, 148
Border Color	255, 89, 104, 100
Brush Style	SimpleGradientVertical
Location	216, 228
X	216
Y	228
Size	120, 36
Width	120
Height	36
Output Wiring Step	0
Input Wiring Step	0

### • [Save Style] button

Click the [Save Style] button to save the information displayed in the "Properties" area to the computer as the default values. These values will be applied to other newly-created projects.

Components, ports, wires, and the design sheet are saved.

Items specified in the "Properties" area can be saved as a user style, so that the next time you place a new component or connect wires, they will be placed with the same appearance as was saved in the style.

If you want to use the same user style on another computer, execute one of the following procedures.

- Use [File] menu → [Export Style] to save the user style as a file; then use [File] menu → [Import Style] on the other computer to load the file.
- Use [File] menu → [Save with Style] to create a project file that includes the user style; then after loading the file on the other computer, use [File] menu → [Import Style from Project File] to load it.

- **Device**

- **Model**

- Indicates the model name.

- **Device Name**

- Indicates the User Defined Name of the target device. Double-click this field to edit the name.

- **Unit ID**

- Indicates the Unit ID for the device. You cannot edit this field while the device is online.

- **Display**

- **Output Wiring Step**

- Set length of output side wiring step. If equal spacing is desired, please set "Wire Routing" to Automatic and set "Auto Block Avoidance" to False.

- **Input Wiring Step**

- Set length of input side wiring step. If equal spacing is desired, please set "Wire Routing" to Automatic and set "Auto Block Avoidance" to False.

- **Object**

When the port of a device or component on the sheet is selected, click the  that appears when you click on Label to open the [Port Label dialog](#).

## 7.5. Placing devices

Here we explain how to place devices on the "Project" sheet.



- If any object in the "Devices" area or "Network" area is selected, pressing an alphabetical key will select the component of the matching initial letter.

- **Drag and drop a device from the "Devices" area into the "Project" sheet.**

You can select the number of devices and the UNIT ID. The UNIT ID can be changed in the "Properties" area.

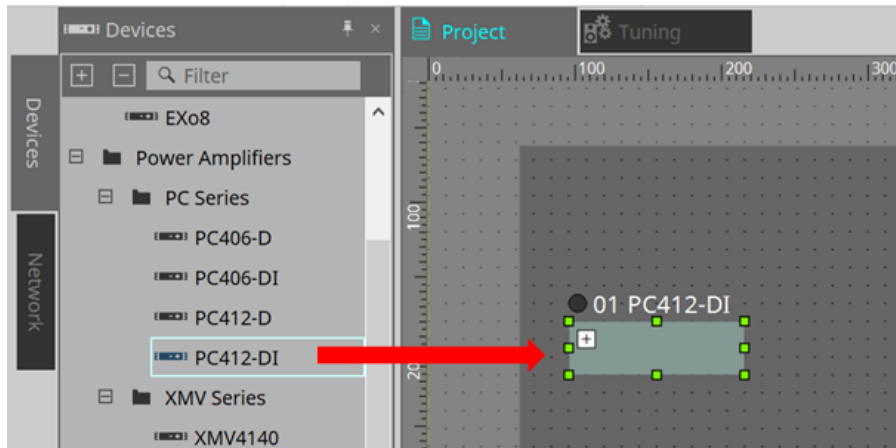

- **Connect the computer to the network of devices, and then drag and drop a device from the "Network" area into the "Project" sheet.**

If a device that you understand to be connected is not shown in the "Network" area, check that the device actually is connected to the network, and that it is powered-on. Speakers are not shown in the "Network" area.

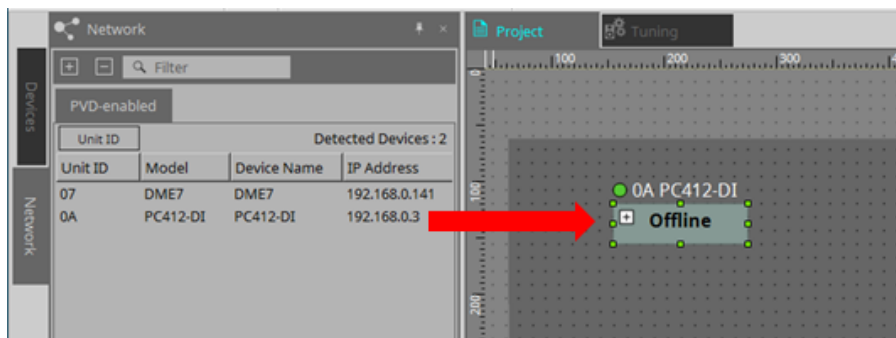

- Double-click [Device Group] to select Stamp mode, and then click the "Project" sheet to place a [Device Group] each time you click the sheet. To exit Stamp mode, press < Esc >.



## 7.6. Selecting multiple objects

Here we explain how to select multiple objects placed in the "Project" sheet.

- **Use the mouse cursor to completely enclose objects**

By dragging the mouse cursor, you can select the objects that are completely enclosed in the rectangular area on the sheet.

- **Hold down < Ctrl > and use the mouse cursor to completely or partially enclose objects**

By dragging the mouse cursor while you hold down < Ctrl >, you can select the objects that are completely or partially enclosed in the rectangular area on the sheet.

To select objects inside a device, start dragging inside that device. Only the objects inside that device are subject to selection.



If the selection encloses a Device Group, and the point at which you start dragging is on the sheet, then the objects on the sheet are selected. If the point at which you start dragging is on a Device Group, then objects inside that Device Group are selected.

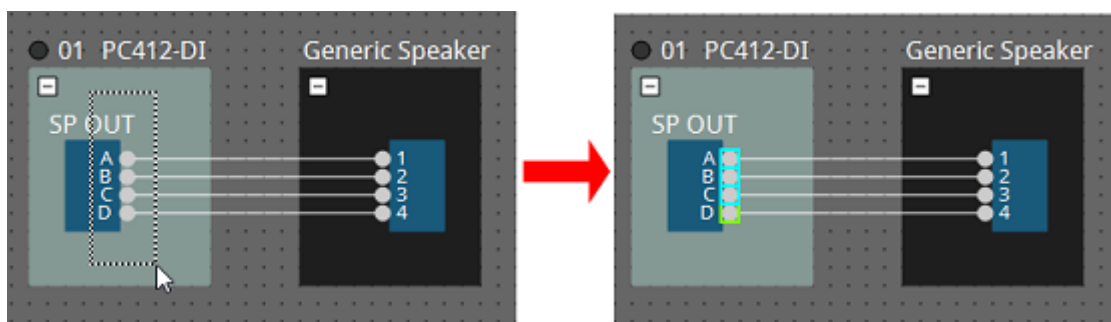

- **Hold down < Ctrl > and click objects**

To select multiple objects, hold down < Ctrl > and click each target that you want to select. If you hold down < Ctrl > and click an object that is already selected, the selection is cleared.

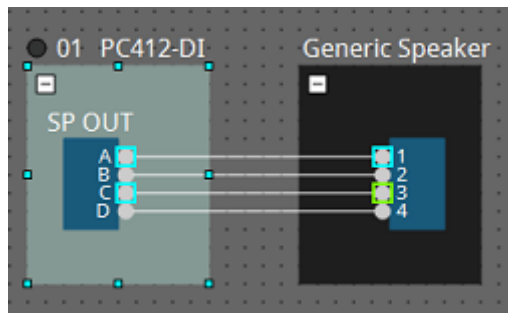

## 7.7. Connecting ports

Here we explain how to make connections between ports of devices by creating a wire between the ports.

- **Make one connection at a time**

Drag one output port to the input port of the destination device.

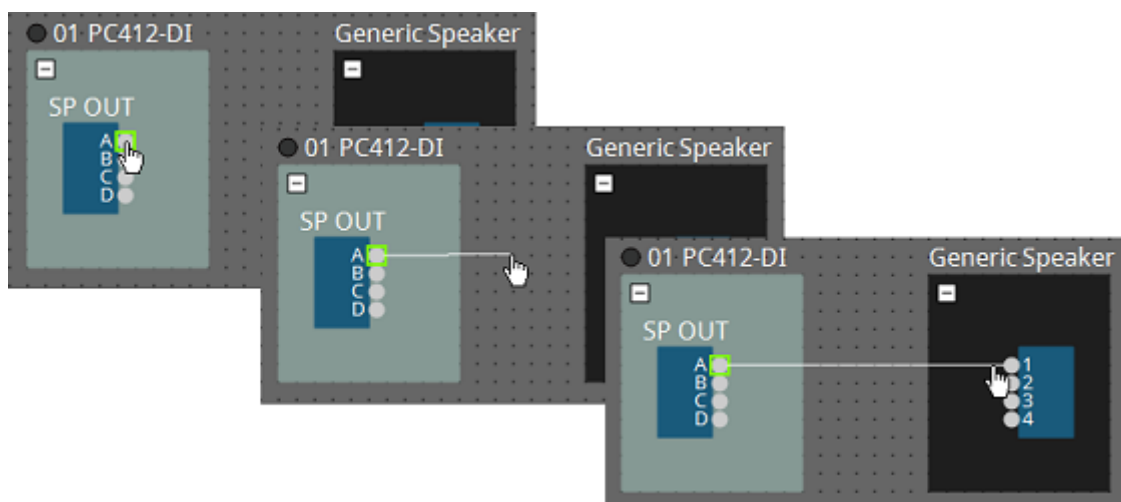

- **Make multiple connections at a time**

Select multiple output ports, and drag one of these ports to an input port of the destination device.

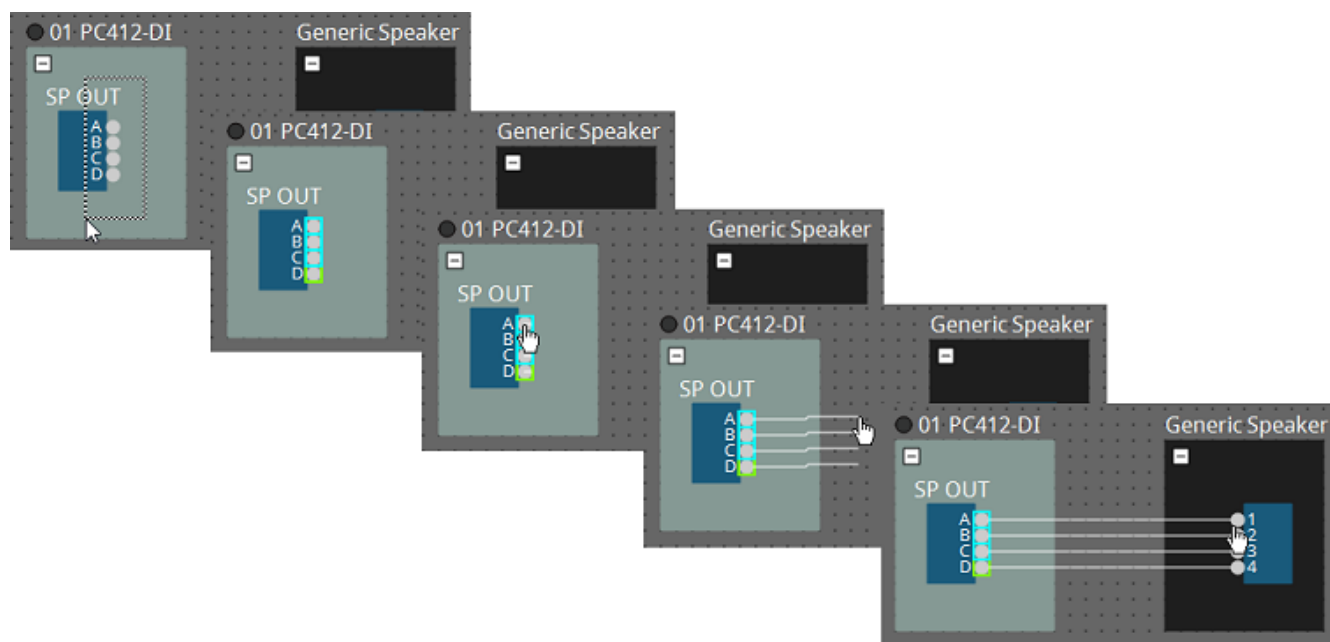

## 7.8. Duplicating devices

Here we explain how to duplicate devices together with their parameters.

- **Right-click an object and choose [Duplicate]**

A duplicate, overlapping object is created. If multiple objects with their wires are selected when you choose [Duplicate], the objects are duplicated together with their wires.

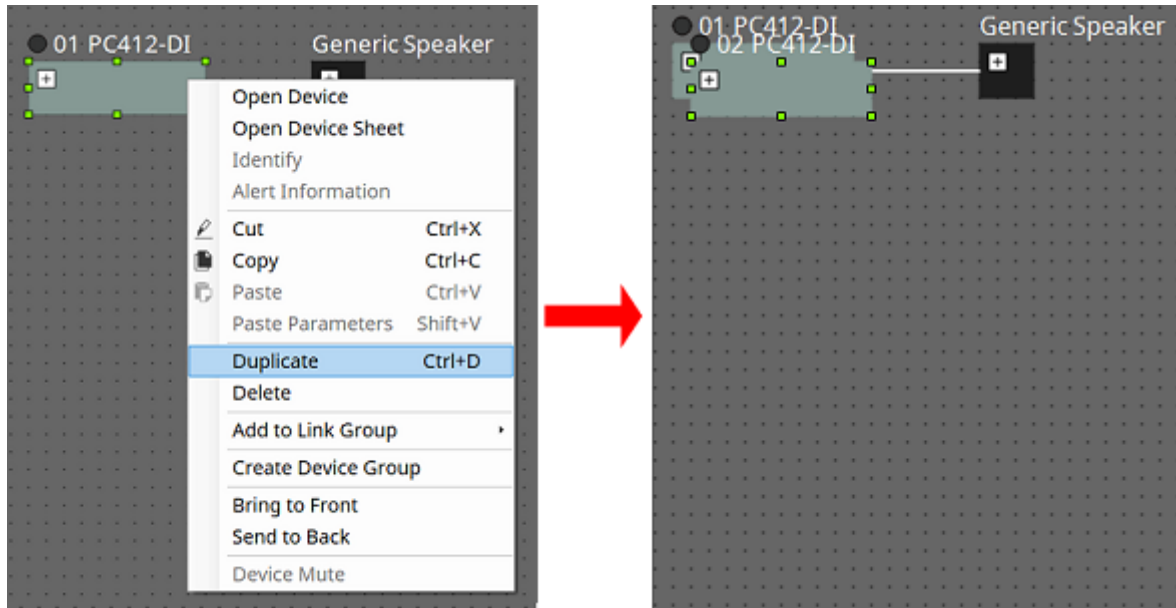

- **Drag and drop an object while holding down < Ctrl >**

A duplicate is created where you drop the object.

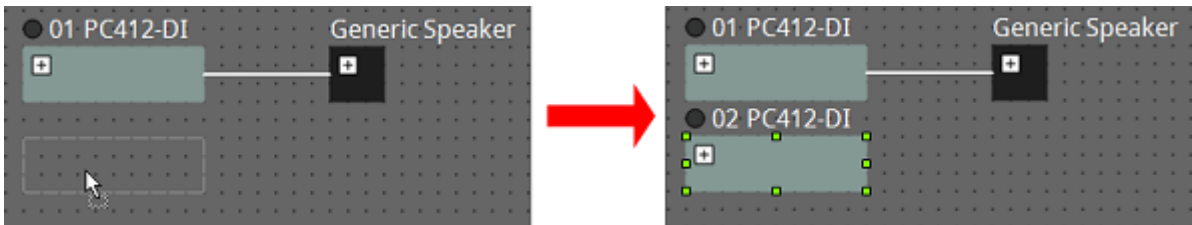

- **Drag and drop objects with their wires while holding down < Ctrl >**

Duplicates of the components together with their wires are created where you drop the component.

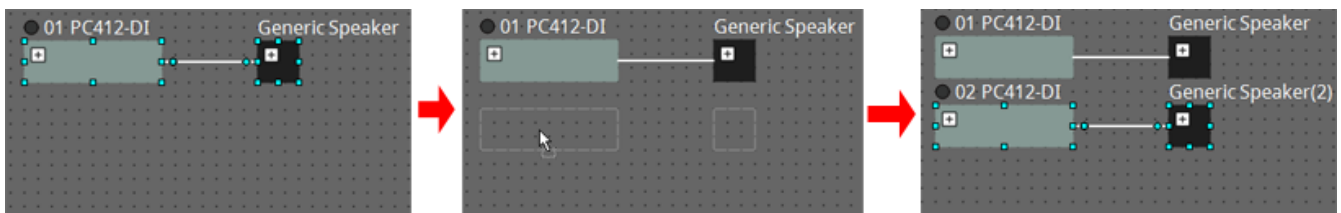

## 7.9. "Group" Editor

The devices in a device group can be powered on/off or muted in a single step.

When you double-click a device group or right-click and choose [Open Group Editor] from the context menu, the "Group Editor" opens.

This is available only when online.

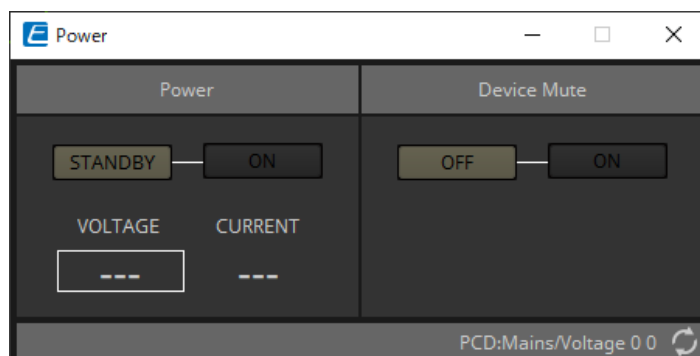

- **"Power" area**

Switches the power of the devices in the device group to standby or on at once.

- **"Device Mute" area**

Enables/disables the mute setting of the devices in the device group at once.

## 8. "Tuning" sheet



The "Tuning" sheet supports only the PC series and XMV series units.

Power amp channels that are grouped across devices of the same series are called a "link group." By using the link group editor, grouped channels can be operated in tandem, as either relative values or absolute values of the same type of parameter.

To create a link group, you can drag and drop a [Group] from the "Components" area of the "Tuning" sheet. In the "Components" area, you can double-click [Group] to enter Stamp mode. A [Group] is placed each time you click the sheet. To exit Stamp mode, press < Esc >.

Registration to a link group can be done in the following ways.

Registration source	Registration method
"Project" sheet	Right-click a device, and use [Add to Link Group] to select the channel and link group that will be registered.
	After selecting multiple devices, right-click a device and use [Add to Link Group] to select the channel and link group that will be registered.
"Tuning" sheet	In the "Project Devices" area, drag and drop a channel from "Amplifiers" or "Speakers" into [Group].
	In the "Project Devices" area, right-click a channel of "Amplifiers" or "Speakers" and use [Add to Link Group] to select the link group to which it will be registered.

When you double-click an object in the "Tuning" sheet, the link group component editor opens. For details on the link group component editor, refer to the component editor of each device.

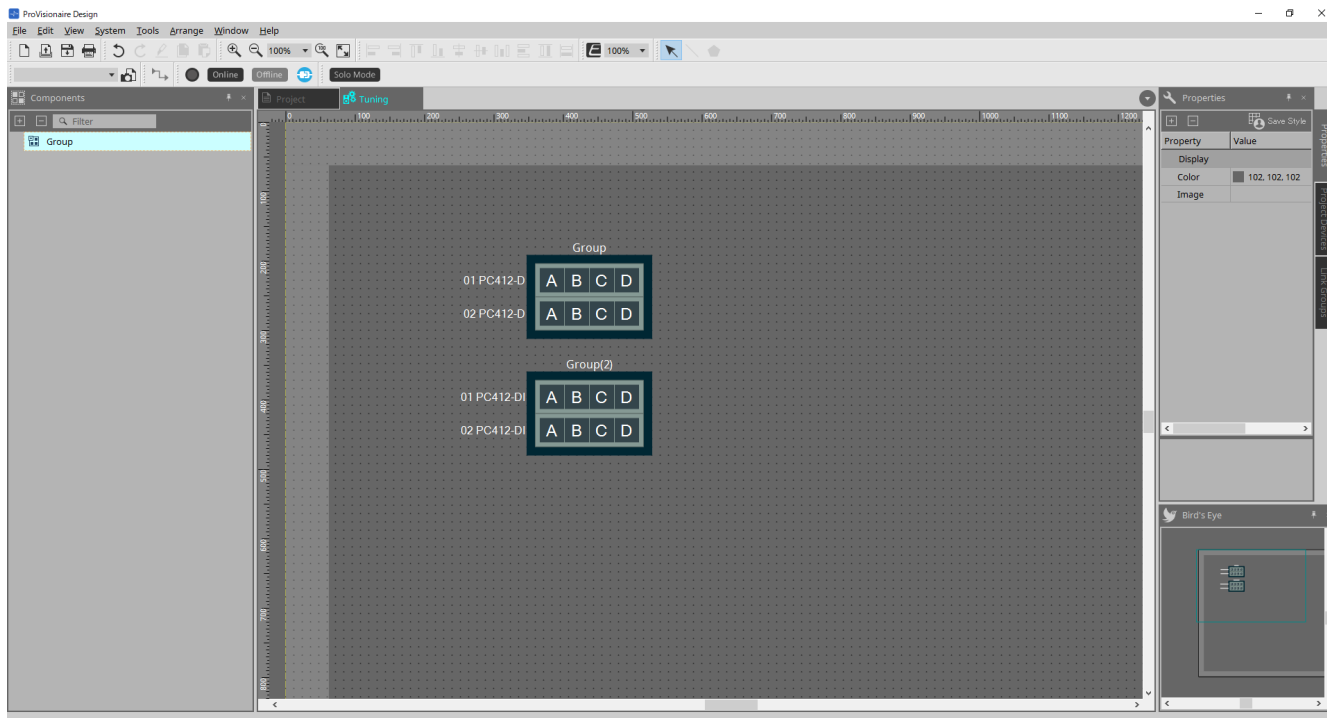

## 8.1. "Tuning" sheet

This visualizes the link groups.

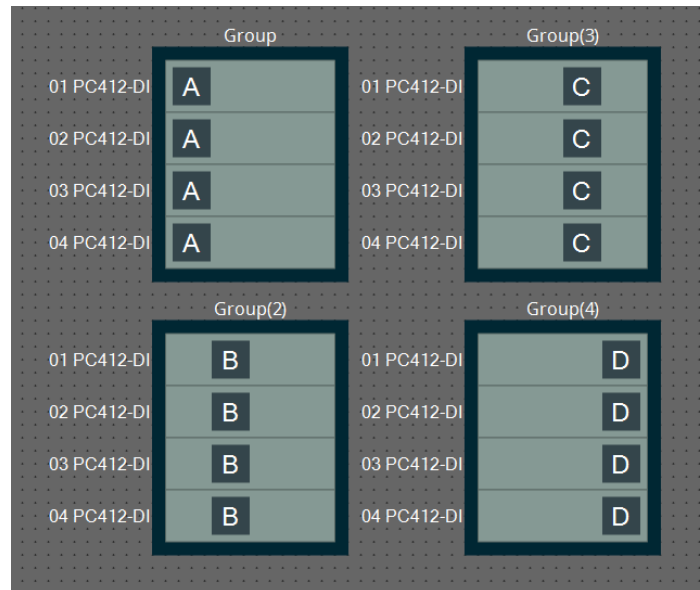

When you right-click a link group and choose [Open Link Group Editor], the link group editor appears. For details on the link group editor, refer to each model of power amp.

## 8.2. "Properties" area

Here you can view and edit information about the sheet or object.

When you click the [Save Style] button, information other than [Location] is saved on the computer, and set as the default settings for that object.

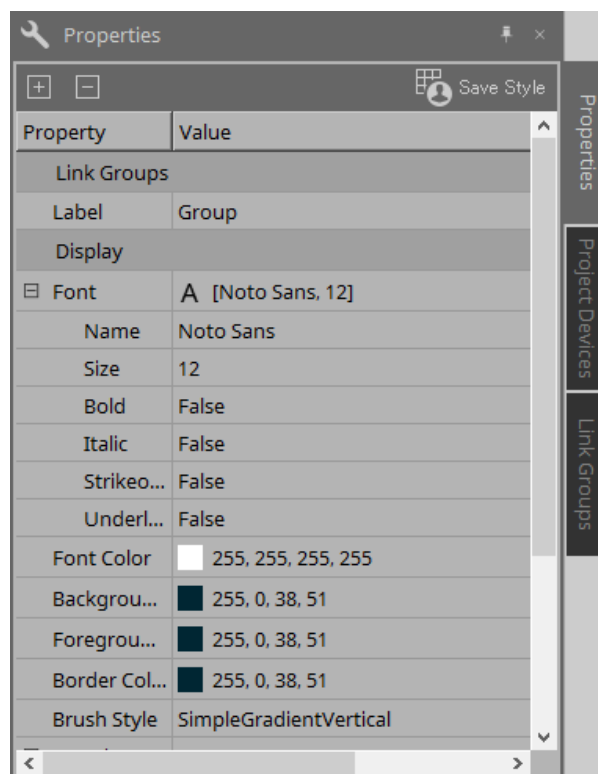

## 8.3. "Project Devices" area

This shows the devices that are registered in the project as a tree.

### 8.3.1. [Amplifiers]

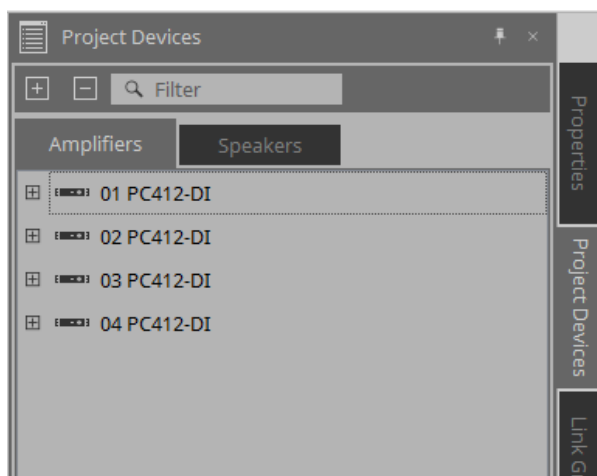

You can expand this to see the channels of the power amp.

Register a channel in a link group by dragging and dropping it onto [Group].

For details on the context menu that appears when you right-click, refer to [Context Menu](#).

### 8.3.2. [Speakers]

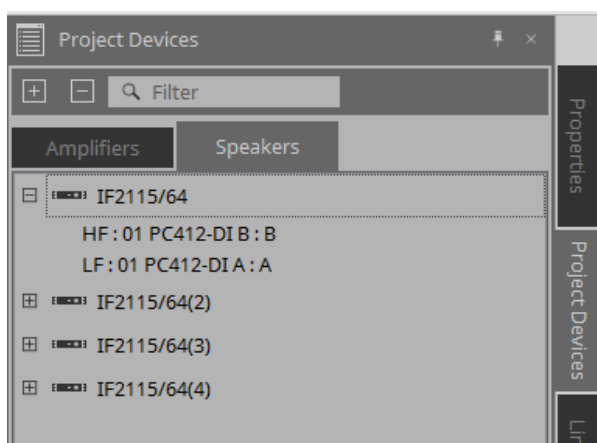

When you expand this, the "Project" sheet shows the channels of the power amps connected to the speaker ports.

Register a channel in a link group by dragging and dropping it onto [Group].

For details on the context menu that appears when you right-click, refer to [Context Menu](#).

## 8.4. "Link Groups" area

This shows a tree view of the link groups and the power amp channels that are registered in the link groups.

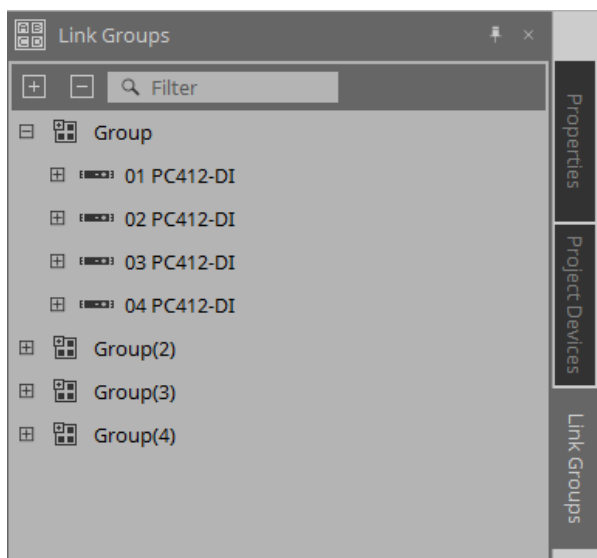

For details on the context menu that appears when you right-click, refer to [Context Menu](#).



## 9. Online and synchronization

You can connect devices to the computer, and send them settings that were created using ProVisionaire Design.

You can also load data from devices into ProVisionaire Design.

The state in which the devices and ProVisionaire Design are operating in synchronization is called the "online state." The action of bringing them into this state is called "Synchronization."

Synchronization will match the settings of ProVisionaire Design and the devices themselves; when the settings of both are in a matching state, they will go online, allowing the devices to be controlled in real time.

### 9.1. Online

To enter the online state in ProVisionaire Design, click the toolbar button [Online] to access the "Synchronization" dialog box.

Alternatively, select "Go Online - From Devices" from the [File] menu.

#### 9.1.1. "Synchronization" dialog box

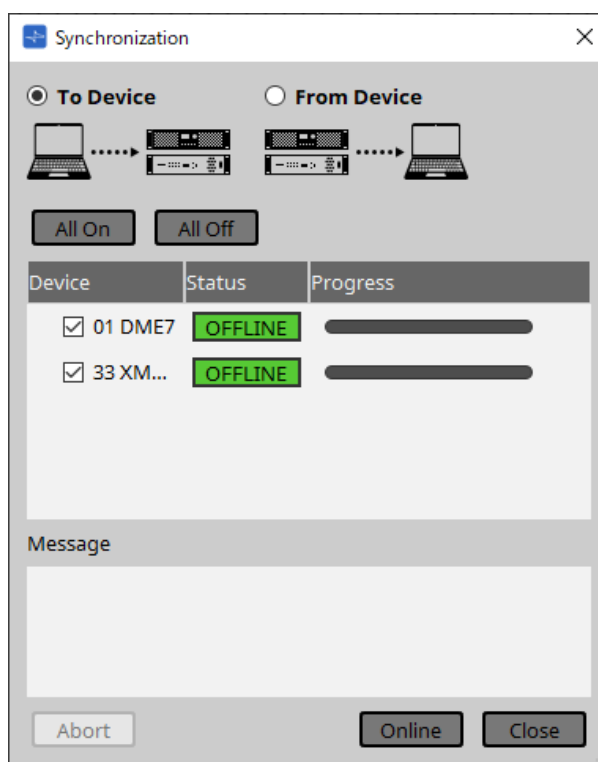

- **[To Device] option button**

Choose this if you want the settings of ProVisionaire Design to be applied to the devices.

- **[From Device] option button**

Choose this if you want the settings of the devices to be reflected in ProVisionaire Design.



The system must have been previously configured using ProVisionaire Design. In addition, you need to use the project file that was created at that time.

- **[All On] button**  
Adds a check mark to the [Device] check boxes of all devices in the device list.
- **[All Off] button**  
Clears the check mark from the [Device] check boxes of all devices in the device list.
- **Device list**  
This shows the devices that are registered in the project.
  - [Device] check box  
Add a check mark to each device that you want to synchronize.
- **Status**  
Indicates the state of synchronization with the device.  
The indication has the following significance.
  - Green: Offline
  - White: Lost  
"Lost" is a state in which ProVisionaire Design cannot find the device, such as because the device is not powered-on.
  - Blue: Online
  - Yellow: Not compatible
- **Progress**  
Shows the progress of synchronization.
- **Message area**  
Details are shown in this area if you click the [Abort] button to stop the process or if an error occurs.
- **[Abort] button**  
Click this to stop synchronization.
- **[Online] button**  
Click this to begin synchronization with the selected devices.
- **[Close] button**  
Cancels synchronization and closes the dialog box.  
This cannot be clicked during synchronization.

### 9.1.2. Procedure

1. In the toolbar, click the [Online] button.  
The "Synchronization" dialog box will appear.
2. Choose either [To Device] or [From Device] to specify the direction in which synchronization will occur.
  - If you choose [To Device]  
The settings of ProVisionaire Design will be transmitted to the devices, overwriting their settings.
  - If you choose [From Device]  
The settings of the devices will be loaded into ProVisionaire Design.
3. Add a check mark for each device that you want to bring online.
4. Click the [Online] button.  
Synchronization will begin.  
The synchronization progress is displayed.  
If you click the [Abort] button, the operation will be halted. This can be a useful way to save time, for example if you've noticed a mistake during synchronization and want to edit a parameter. The settings will have been partially transmitted, so after you've made changes, be sure to complete synchronization to the end.  
When synchronization has ended successfully, the dialog box will close automatically.

### 9.1.3. 「Go Online- From Devices」 dialog box

The settings for the devices found on the network can be applied to the currently-edited project file or to a new file. If the system was previously configured using ProVisionaire Design but no project file from the configuration is available, you can still apply the device settings to the current project file.

To open this dialog box, click [Go Online - From Devices] from the [File] menu on the menu bar.

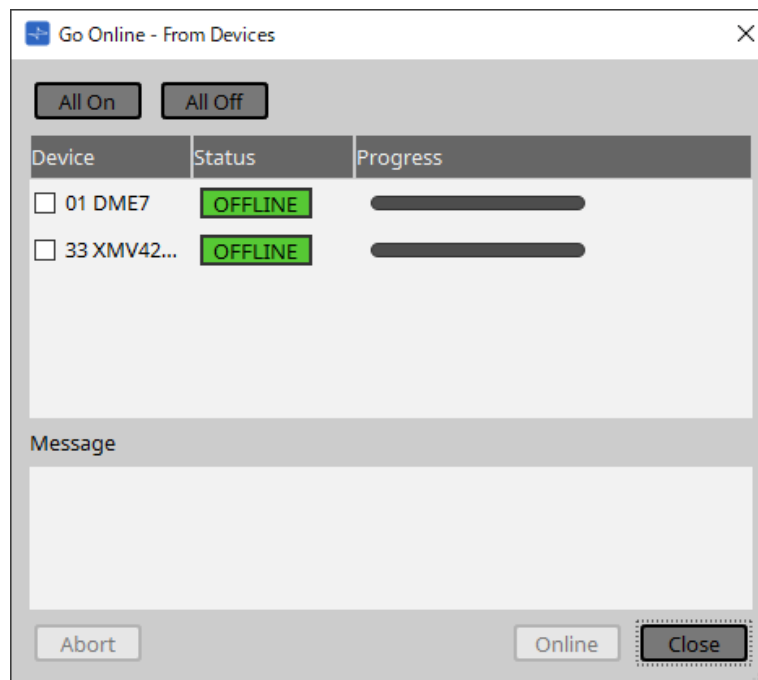

- **[All On] button**

Adds a check mark to the [Device] check boxes of all devices in the device list.

- **[All Off] button**

Clears the check mark from the [Device] check boxes of all devices in the device list.

- **Device list**

This shows the devices that are registered in the project.

- [Device] check box  
Add a check mark to each device that you want to synchronize.

- **Status**

Indicates the state of synchronization with the device.

The indication has the following significance.

- Green: Offline
- White: Lost  
"Lost" is a state in which ProVisionaire Design cannot find the device, such as because the device is not powered-on.
- Blue: Online
- Yellow: Not compatible

- **Progress**

Shows the progress of synchronization.

- **Message area**

Details are shown in this area if you click the [Abort] button to stop the process or if an error occurs.

- **[Abort] button**

Click this to stop synchronization.

- **[Online] button**  
Click this to begin synchronization with the selected devices.
- **[Close] button**  
Cancels synchronization and closes the dialog box.  
This cannot be clicked during synchronization.

## 9.2. Offline

To enter the offline state in ProVisionaire Design, click the toolbar button [Offline] to access the "Offline" dialog box.

### 9.2.1. "Offline" dialog box

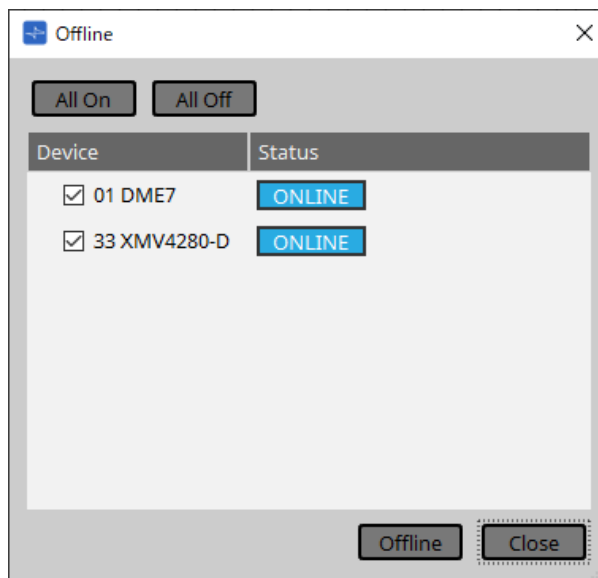

- **[All On] button**

Adds a check mark to the [Device] check boxes of all devices in the device list.

- **[All Off] button**

Clears the check mark from the [Device] check boxes of all devices in the device list.

- **Device list**

This shows the devices that are registered in the project.

- **[Device] check box**

Add a check mark for each device that you want to take offline.

- **Status**

Indicates the state of synchronization with the device.

The indication has the following significance.

- Green: Offline

- White: Lost

"Lost" is a state in which ProVisionaire Design cannot find the device, such as because the device is not powered-on.

- Blue: Online

- Yellow: Not compatible

- **[Offline] button**

When you click this, the selected devices go offline with ProVisionaire Design.

- **[Close] button**

Closes the dialog box.

# 10. Dialog boxes

This chapter explains the dialog boxes and windows that you can open from the menu bar or tool bar.

## 10.1. Startup dialog box

This appears when ProVisionaire Design starts.

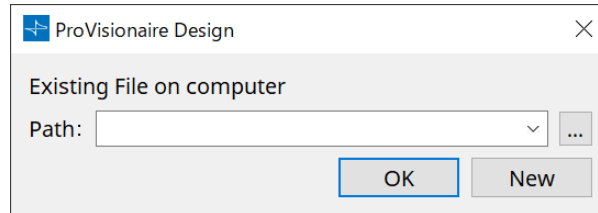

- **[Path] pulldown menu**  
Lets you view and select a recently saved project file.
- **[...] button**  
Opens the "Select File" dialog box. Select the project file that you want to load.
- **[OK] button**  
Loads the project file that is shown in the [Path] pulldown menu.
- **[New] button**  
Starts a new project.

## 10.2. "Go Online- From Devices" dialog box

To open this dialog box, click [Go Online - From Devices] from the [File] menu on the menu bar. For more information on the "Go Online - From Devices" dialog box, refer to the "Online and synchronization" chapter.

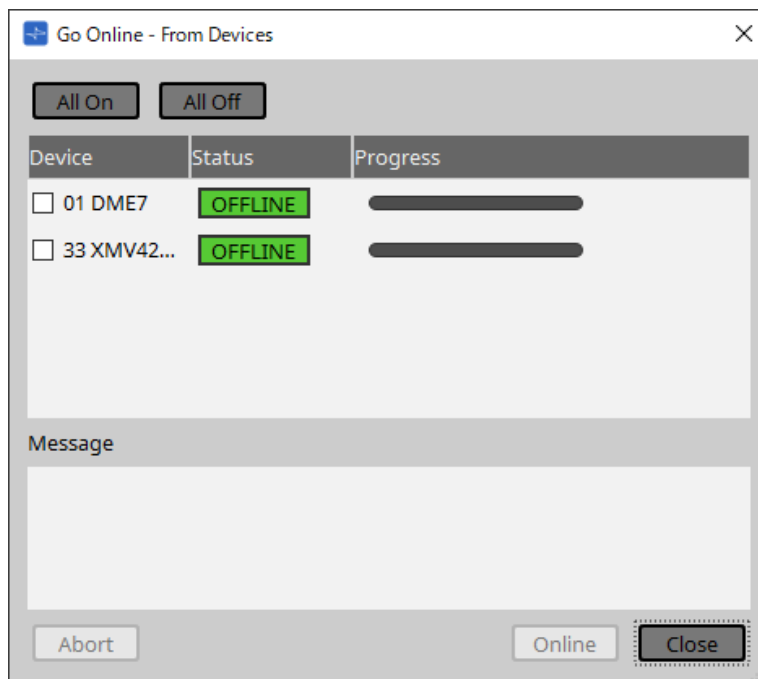

## 10.3. "Protect File" dialog box

To open this dialog box, click [Protect File] from the [File] menu on the menu bar.

In ProVisionaire Design, you can specify a PIN code (secret number) in the project file for security.

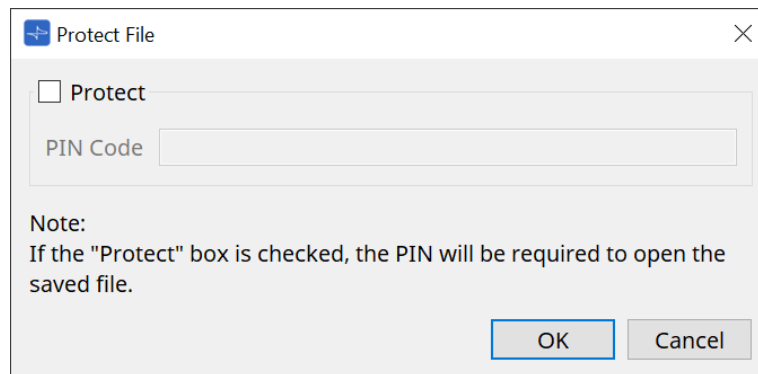

- **[Protect] check box**

If this check box is selected, the "Security" dialog box will appear when the project file starts.

If this check box is cleared, all users will be able to open the project file.

- **[PIN Code]**

If the [Protect] check box is selected, enter the PIN code (secret pass code). (The code should be six alphanumeric characters drawn from numbers 0 through 9 and letters a, b, c, d, e, and f. The code is not case sensitive.)



If you forget the PIN code, you will be unable to open the corresponding project file.

- **[OK] button**

Updates the settings and closes the dialog box.

- **[Cancel] button**

Closes the dialog box without updating the settings.



## 10.4. "Project Information" dialog box

To open this dialog box, click [Project Information] from the [File] menu on the menu bar.  
Allows you to include a memo in the project file to record property information or contact information.

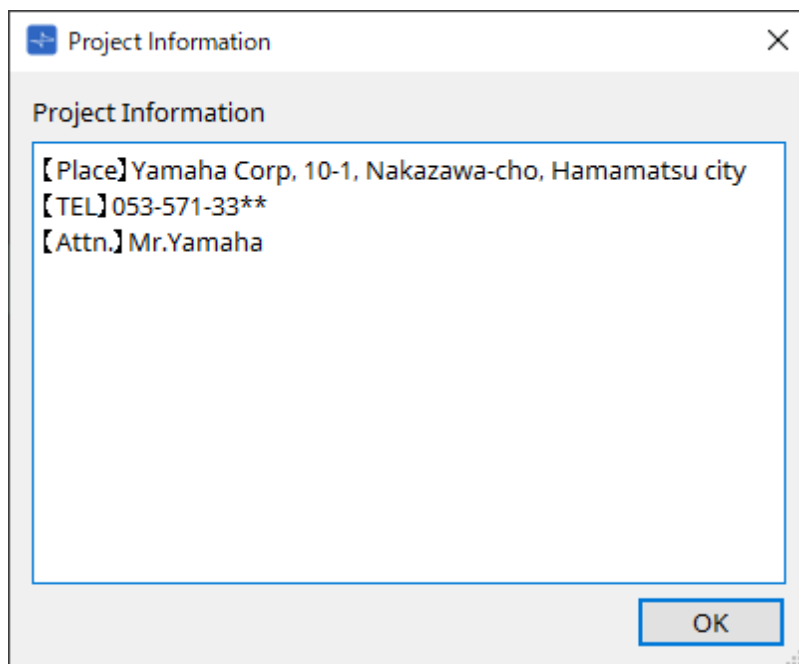

## 10.5. "Print" dialog box

To open this dialog box, click [Print] from the [File] menu on the menu bar.

Here you can make settings related to printing a sheet, specify the size of paper shown on the sheet, and see a print preview.

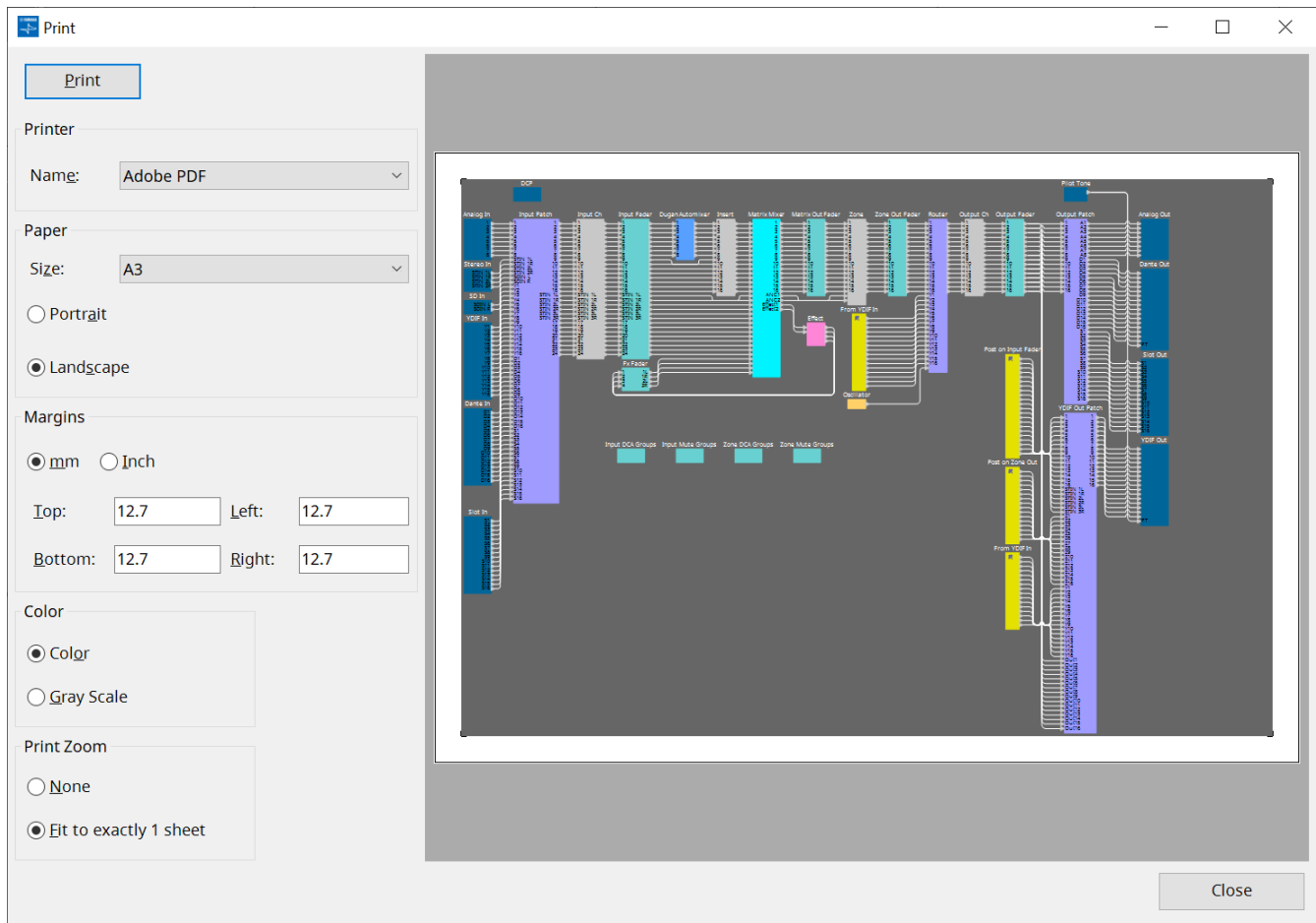

- **[Print] button**

Click this to open the Windows "Print" dialog box.

- **Printer**

- **[Name] list box**  
Specifies the printer to use.

- **Paper**

- **[Size] list box**  
Specifies the size of the paper. If the [View] menu item [Print Area] has a check mark, the size of paper shown on the design sheet follows this setting.
- **[Portrait]/[Landscape] option buttons**  
Specify the orientation of the paper. The orientation of the paper shown on the design sheet follows this setting.

- **Margins**

- **[mm]/[Inch] option buttons**  
Specify the units for the top, bottom, left, and right margins.
- **[Top]/[Bottom]/[Left]/[Right] text boxes**  
Specify the top, bottom, left, and right margins.

- **Color**

- **[Color]/[Gray Scale] option buttons**  
Specify whether to print in color or in gray scale.

- **Print Zoom**

- **[None]/[Fit on one page] option buttons**  
Specify either that the printed content will be the region within the paper shown on the design sheet, or that the entire sheet will be reduced in size to fit on a single page.

- **Preview area**

Shows a print preview.

## 10.6. "File Storage" dialog box

To open this dialog box, click [File Storage] from the [File] menu on the menu bar. You can save the project file from ProVisionaire Design to the DME7 unit. Only one project file can be saved to each DME7 unit.

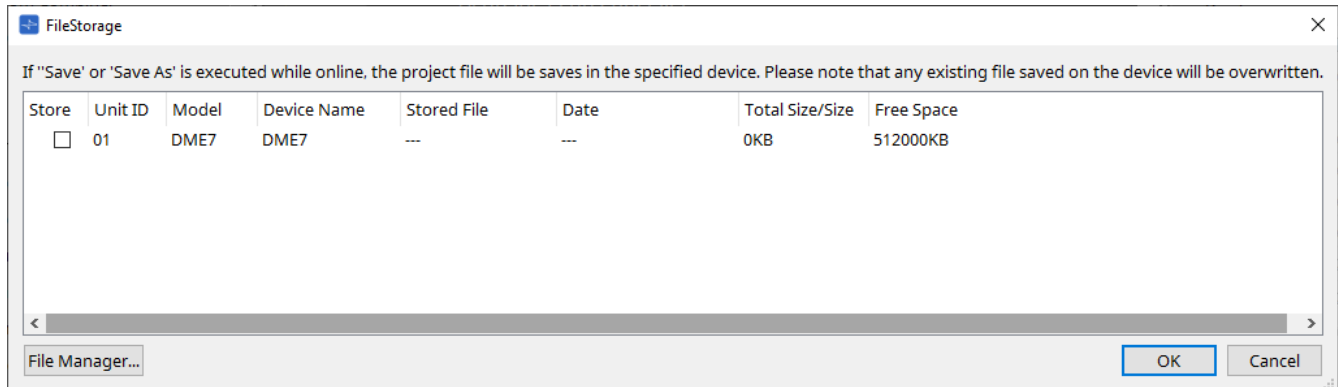

All DME7 units that are detected by ProVisionaire Design will be listed.

- **[Store] check box**

Enables you to select a DME7 unit to which you wish to save the project file. You can select multiple DME7 units.

If you execute the Save, Save As, or Save with Style command while ProVisionaire Design and the devices are connected online, the project file will be automatically transferred and saved not only to the computer but also to currently-selected multiple DME7 units.



Please be aware that at this time, the files that are currently stored on the devices will be overwritten.

- **Unit ID / Model / Device Name**

These columns indicate the device Unit ID, device model name, and device name.

To change the device name, use the [Device Name] field in the "Properties" area of the "Project" sheet.

- **Stored File**

If any file is stored on the device, this field will indicate the name of the file.

If no file is stored on the device, this field will be empty. If no device is detected, this field will indicate "---."

- **Date**

If a file has already been stored on the device, this field will indicate the date and time at which the file was updated.

If no file is stored on the device, this field will be empty. If no device is detected, this field will indicate "---."

- **Total Size/Size**

For a device, this field indicates the size of the save destination. For a file, this field indicates the file size.

If no device is detected, this field will indicate "---."

- **Free Space**

This field applies only to the device, and indicates the available space at the save destination.

If no device is detected, this field will indicate "---."

- **[File Manager] button**

Click this button to open the [File Manager] dialog box.

### 10.6.1. [File Manager] dialog box

To open this dialog box, click the [File Manager] button in the [File Storage] dialog box. You can save any project file to the DME7.

As the save destination, you can specify any DME7 unit that ProVisionaire Design detects on the network.

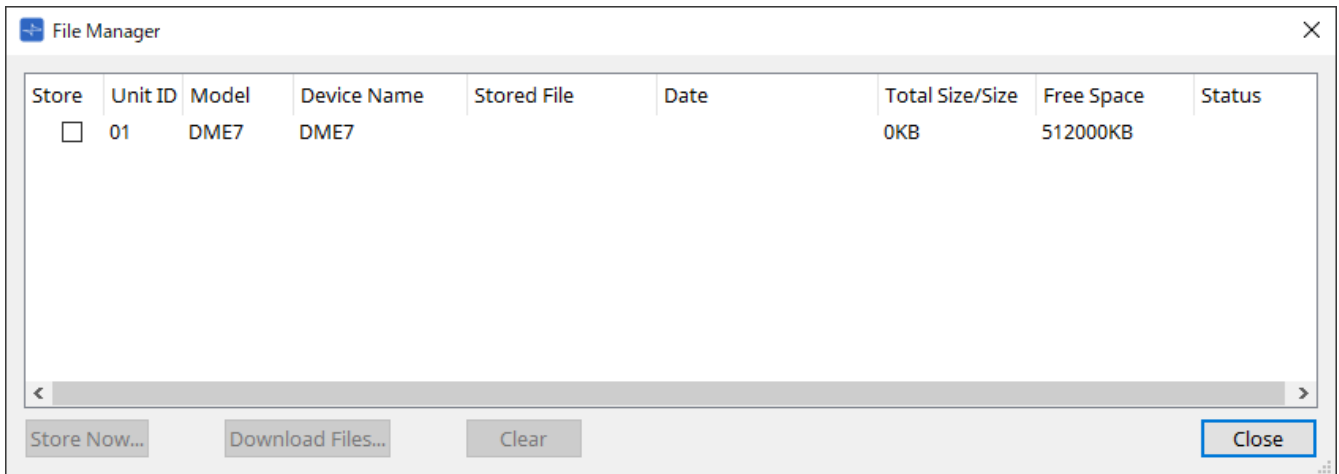

- **[Store] check box**  
Enables you to select the save destination(s) when the “Store Now” command is executed. You can select multiple destinations.
- **Status**  
Indicates the progress status of the save operation when the “Store Now” command is executed.
- **[Store Now] button**  
Transfers the project file to the device(s) for which the check box has been marked.
- **[Download Files] button**  
Downloads the file from a device for which the check box has been marked.
- **[Clear] button**  
Deletes a file that is stored on a device for which the check box has been marked.

## 10.7. "Network Setup" dialog box

To open this dialog box, click [Network Setup] from the [System] menu on the menu bar.

Here you can select the computer's network interface card (subsequently called the "network card") used for communicating with devices.

You can also change the IP address of the network card.



If you're not using a DHCP server, fix the IP address of your computer's network card. We recommend the following settings.

IP address: 192.168.0.253

Subnet mask: 255.255.255.0

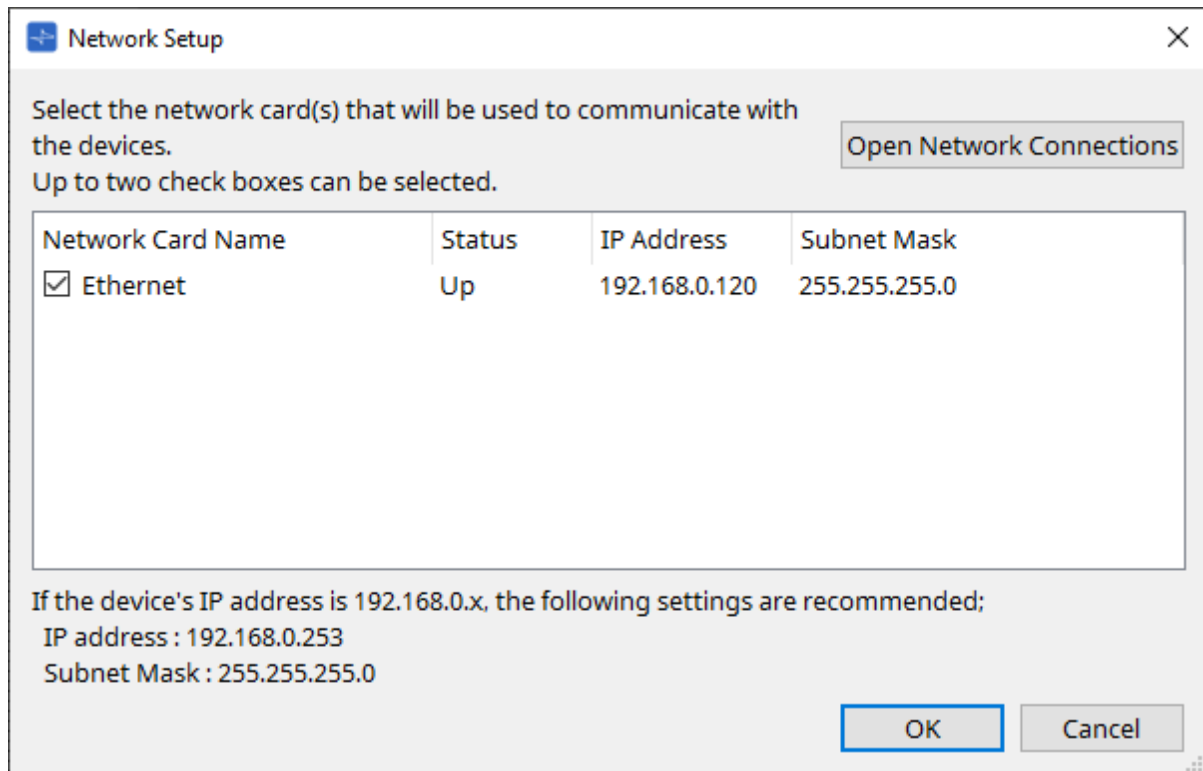

If the computer is not connected to the network, click the [Cancel] button to close the dialog box.

- **Network Card Name**  
Shows the name of the network card.
- **Status**  
Shows the status of the network card (Up or Down).
- **IP Address and Subnet Mask**  
Indicates the IP address and subnet mask that are assigned to the network card.  
Select a network card of the same subnet as the devices.
- **[Open Network Connections] button**  
Opens the control panel "Network Connections." Use this when you want to change the IP address of the network card.
- **[OK] button**  
Updates the settings and closes the dialog box.
- **[Cancel] button**  
Closes the dialog box without updating the settings.

## 10.8. "IP Settings" dialog box

To open this dialog box, click [IP Settings] from the [System] menu on the menu bar.  
Lists the devices found on the network, allowing you to change their IP address.

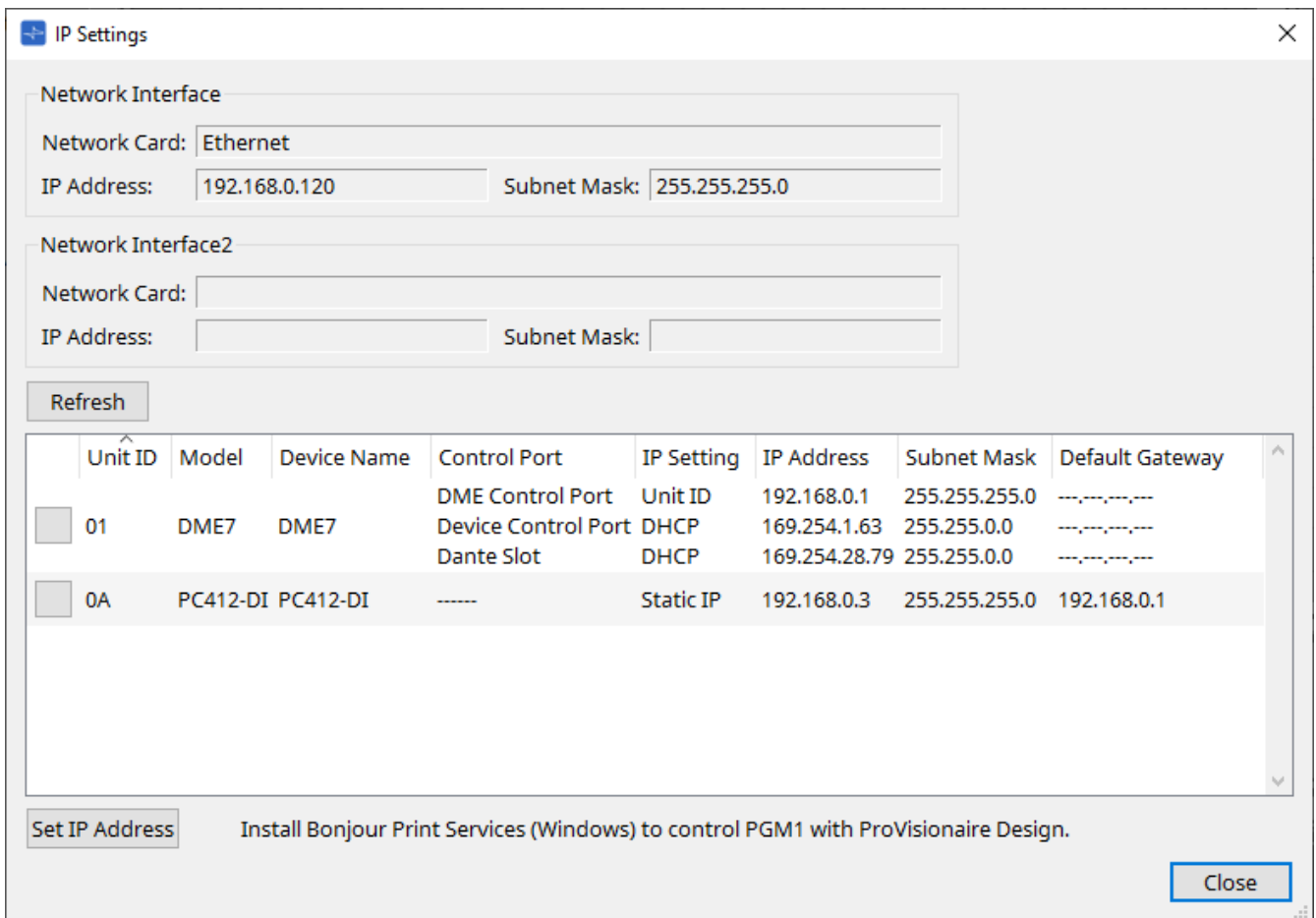

IP Settings

Network Interface

Network Card: Ethernet

IP Address: 192.168.0.120 Subnet Mask: 255.255.255.0

Network Interface2

Network Card:

IP Address: Subnet Mask:

Refresh

Unit ID	Model	Device Name	Control Port	IP Setting	IP Address	Subnet Mask	Default Gateway
01	DME7	DME7	DME Control Port	Unit ID	192.168.0.1	255.255.255.0	---,---,---
			Device Control Port	DHCP	169.254.1.63	255.255.0.0	---,---,---
			Dante Slot	DHCP	169.254.28.79	255.255.0.0	---,---,---
0A	PC412-DI	PC412-DI	-----	Static IP	192.168.0.3	255.255.255.0	192.168.0.1

Set IP Address

Install Bonjour Print Services (Windows) to control PGM1 with ProVisionaire Design.

Close

- **Network Interface**

Shows the name/IP address/subnet mask of the network card currently selected in the "Network Setup" dialog box.

- **[Refresh] button**

Searches again for devices on the network.

- **Device list**

- **Identify button**

When you press this button located at the left of the UNIT ID, the indicators of the corresponding device will flash for several seconds.

- **Unit ID / Model / Device Name**

These columns indicate the device Unit ID, device model name, and device name. If there is a UNIT ID conflict, an ⚠ indication is shown.

To change the device name, use the [Device Name] field in the "Properties" area of the "Project" sheet.

- **Control Port**

Indicates the port name if multiple control ports exist.

- **IP Settings**

Indicates the IP setting type.

- **IP Address/MAC Address/Subnet Mask/Default Gateway**

Indicates the IP address, MAC address, subnet mask, and default gateway that are specified for the device.

- **[Set IP Address] button**  
Opens the "IP Address" dialog box.
- **[Close] button**  
Closes the dialog box.



## 10.9. "IP Address" dialog box

To open this dialog box, click the [Set IP Address] button in the [IP Settings] dialog box. Here you can set the device's IP settings. Set this so that there is no conflict between devices.



Editing is not possible while online.

In order to use ProVisionaire Design to control devices of differing subnets, it is necessary to operate the devices using fixed IP addresses. For details, refer to ["Settings for controlling devices across subnets"](#).

### ■ For the DME7

Specify the parameters on the three tabs: DME Control Port, Device Control Port, and Dante Slot.

Unit ID	Model	Device Name
01	DME7	DME7
0A	PC412-DI	PC412-DI

Unit ID  
 IP Address : 192 . 168 . 0 . 1  
 Subnet Mask : 255 . 255 . 255 . 0  
 DHCP  
 Static IP  
 IP Address : 192 . 168 . 0 . 1  
 Subnet Mask : 255.255.255.0

Default Gateway / DNS Server  
 Default Gateway : [ ] . [ ] . [ ] . [ ]  
 DNS Server : [ ] . [ ] . [ ] . [ ]  
 Obtain Default Gateway and DNS Server addresses automatically  
Only Valid when using 'PC-DHCP' mode.  
 Manually entered 'Default gateway' and 'DNS Server' addresses will be ignored.

Reboot the device when its IP address or UNIT ID has been changed.

### ● DME Control Port and Device Control Port tabs

#### • [Unit ID] radio button (DME Control Port tab only)

Automatically assigns the IP address based on the UNIT ID of the device.

This assigns the IP address as 192.168.0.UNIT ID and the subnet mask as 255.255.255.0.

#### • [DHCP] option button

Click this button to automatically set the IP address, subnet mask, default gateway, and DNS server from the DHCP server.

If there is no DHCP server, the DME Control Port parameters will not be defined. For the Device Control Port, the link local address will be automatically set.

#### • [Static IP] option button

Assigns a fixed IP address for the device.

- **[Default Gateway] text box**

Assigns the IP address of the default gateway.

- **DNS Server**

Enter the DNS server address.

- **[Obtain Default Gateway and DNS Server address automatically] check box**

If this check box is selected, the IP address of the default gateway is obtained automatically. The above IP address setting for the default gateway is ignored.

- **[Apply to all the devices] button**

The status of the default gateway and DNS server will be applied to the DME7 units.



When making settings, be aware that the network for the DME Control Port and the network for the Device Control Port should not overlap (conflict).

- **Dante Slot tab**

Unit ID	Model	Device Name
01	DME7	DME7
0A	PC412-DI	PC412-DI

IP Address dialog box tabs: DME Control Port, Device Control Port, Dante Slot

IP Setting

DHCP

Static IP

IP Address : [ ] . [ ] . [ ] . [ ]

Subnet Mask : [ 255.255.255.0 ]

Apply to all devices

Auto-Assign IP Address

Reboot the device when its IP address or UNIT ID has been changed.

OK Cancel



Use Dante Controller to set the IP address for the Dante Port. When setting this IP address, if you select "Manually Set IP Address," make sure that the Dante Slot is set to the same network.

■ For the Rio3224-D2 / Rio1608-D2

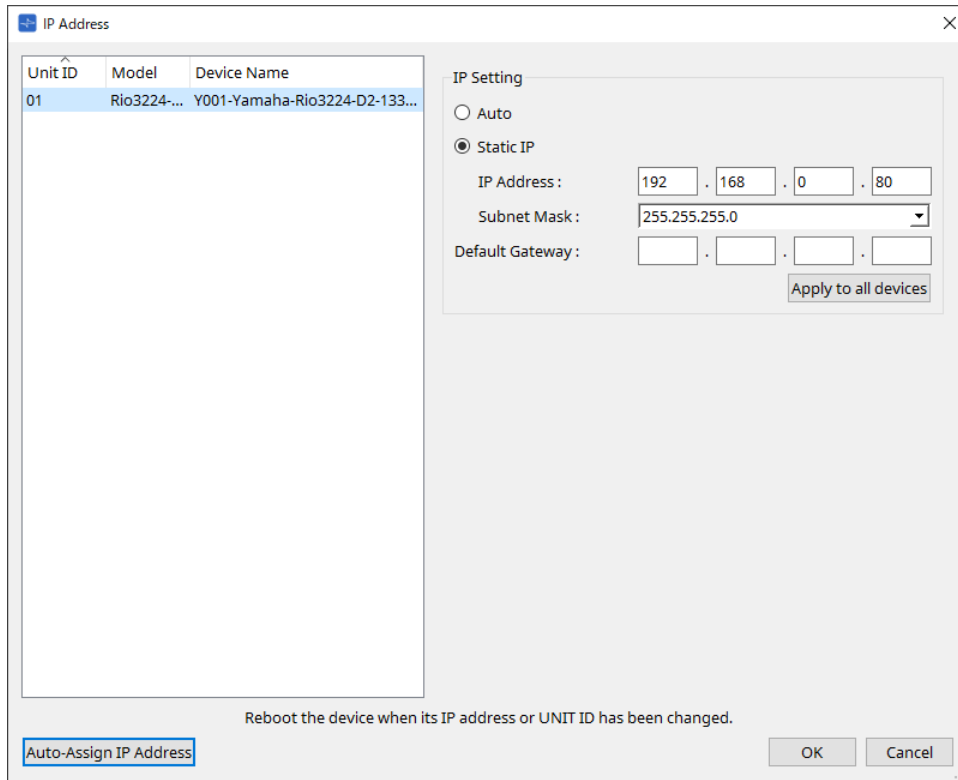

■ For the Tio1608-D / Tio1608-D2

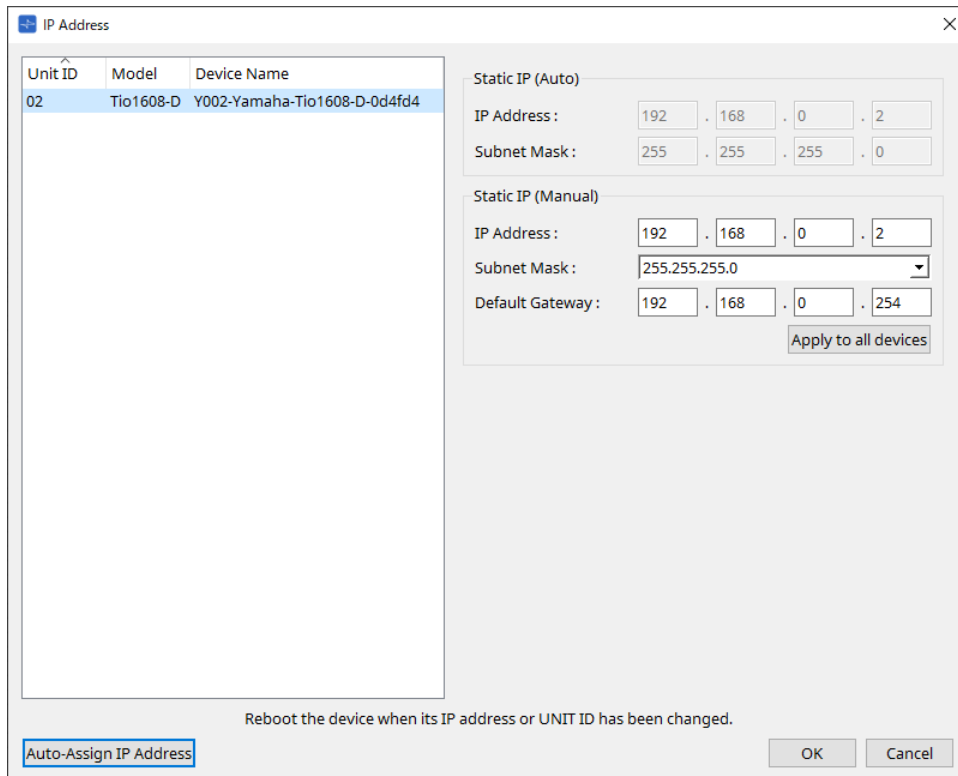

■ For the RSio64-D

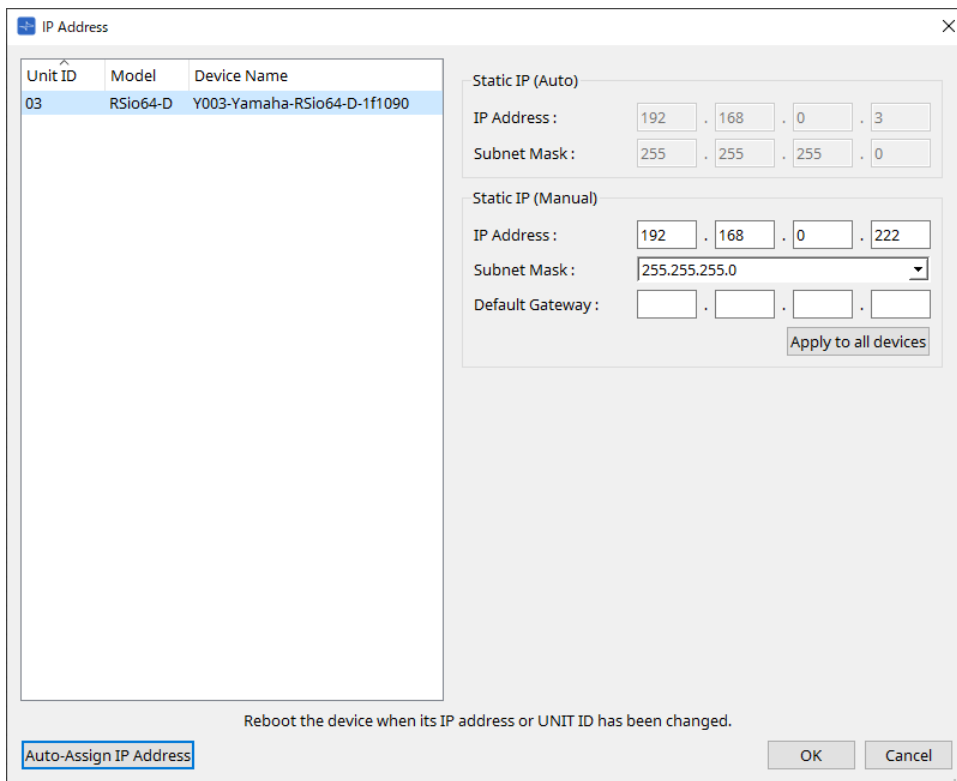

■ For the PC series

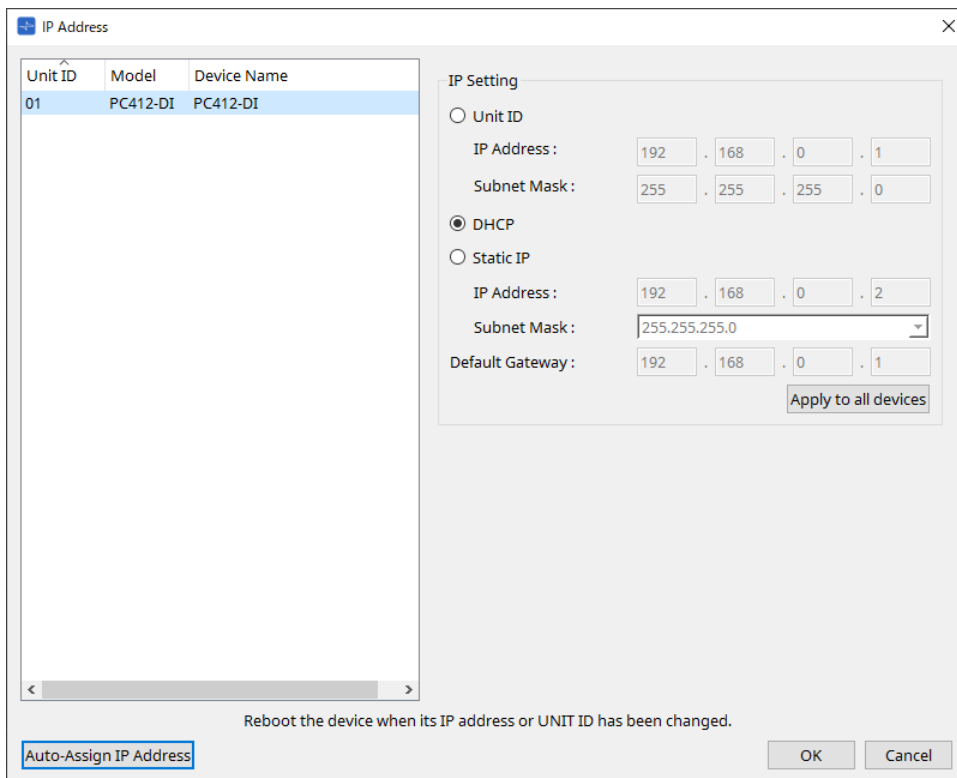

### ■ For the XMV series

Unit ID	Model	Device Name
33	XMV428...	XMV4280-D

IP Setting : Unit ID  
 IP Address : 192 . 168 . 0 . 1  
 Subnet Mask : 255 . 255 . 255 . 0

IP Setting : PC  
 DHCP  
 Static IP  
 IP Address : 192 . 168 . 0 . 2  
 Subnet Mask : 255.255.255.0

Default Gateway / DNS Server  
 Default Gateway : . . . .  
 DNS Server : . . . .  
 Obtain Default Gateway and DNS Server addresses automatically  
 Only Valid when using 'PC-DHCP' mode.  
 Manually entered 'Default gateway' and 'DNS Server' addresses will be ignored.

Reboot the device when its IP address or UNIT ID has been changed.

Auto-Assign IP Address OK Cancel



If you don't know the network address of the unit, we recommend that you use the DIP switch to set IP Setting to [UNIT ID].

### ■ For the MTX series/PGM1/EXi8/EXo8

Unit ID	Model	Device Name
01	MTX3	MTX3

IP Setting : Unit ID  
 IP Address : 192 . 168 . 0 . 1  
 Subnet Mask : 255 . 255 . 255 . 0

IP Setting : PC  
 DHCP  
 Static IP  
 IP Address : 192 . 168 . 0 . 2  
 Subnet Mask : 255.255.255.0

Default Gateway / DNS Server  
 Default Gateway : . . . .  
 DNS Server : . . . .  
 Obtain Default Gateway and DNS Server addresses automatically  
 Only Valid when using 'PC-DHCP' mode.  
 Manually entered 'Default gateway' and 'DNS Server' addresses will be ignored.

Reboot the device when its IP address or UNIT ID has been changed.

Auto-Assign IP Address OK Cancel



If you don't know the network address of the unit, we recommend that you use the DIP switch to set IP Setting to [UNIT ID].

### ■ For the RM-CG/RM-TT

IP Address

Unit ID	Model	Device Name
01	RM-CG	Y001-Yamaha-RM-CG-B49A45

IP Setting

DHCP

Static IP

IP Address : 192 . 168 . 0 . 1

Subnet Mask : 255.255.255.0

Apply to all devices

Default Gateway: [ ] . [ ] . [ ] . [ ]

Primary DNS: [ ] . [ ] . [ ] . [ ]

Secondary DNS: [ ] . [ ] . [ ] . [ ]

Apply to all devices

Reboot the device when its IP address or UNIT ID has been changed.

Auto-Assign IP Address

OK Cancel

### ■ For the VXL1-16P

IP Address

Unit ID	Model	Device Name
65	VXL1-16P	Y065-Yamaha-VXL1-16P

IP Setting : Unit ID

IP Address : 192 . 168 . 0 . 1

Subnet Mask : 255 . 255 . 255 . 0

IP Setting : PC

DHCP

Static IP

IP Address : 192 . 168 . 0 . 2

Subnet Mask : 255.255.255.0

Apply to all devices

Default Gateway / DNS Server

Default Gateway : [ ] . [ ] . [ ] . [ ]

DNS Server : [ ] . [ ] . [ ] . [ ]

Obtain Default Gateway and DNS Server addresses automatically

Only Valid when using 'PC-DHCP' mode.  
Manually entered 'Default gateway' and 'DNS Server' addresses will be ignored.

Apply to all devices

Reboot the device when its IP address or UNIT ID has been changed.

Auto-Assign IP Address

OK Cancel

## 10.10. "Auto-Assign IP Addresses" dialog box

To open this dialog box, click the [Auto-Assign IP Addresses] button in the [IP Address] dialog box. Information such as the IP address assigned to virtual devices specified in the "Match Devices by IP Address" dialog box is applied to the "IP Settings" dialog box in a single operation. For details, refer to "[Settings for controlling devices across subnets](#)".

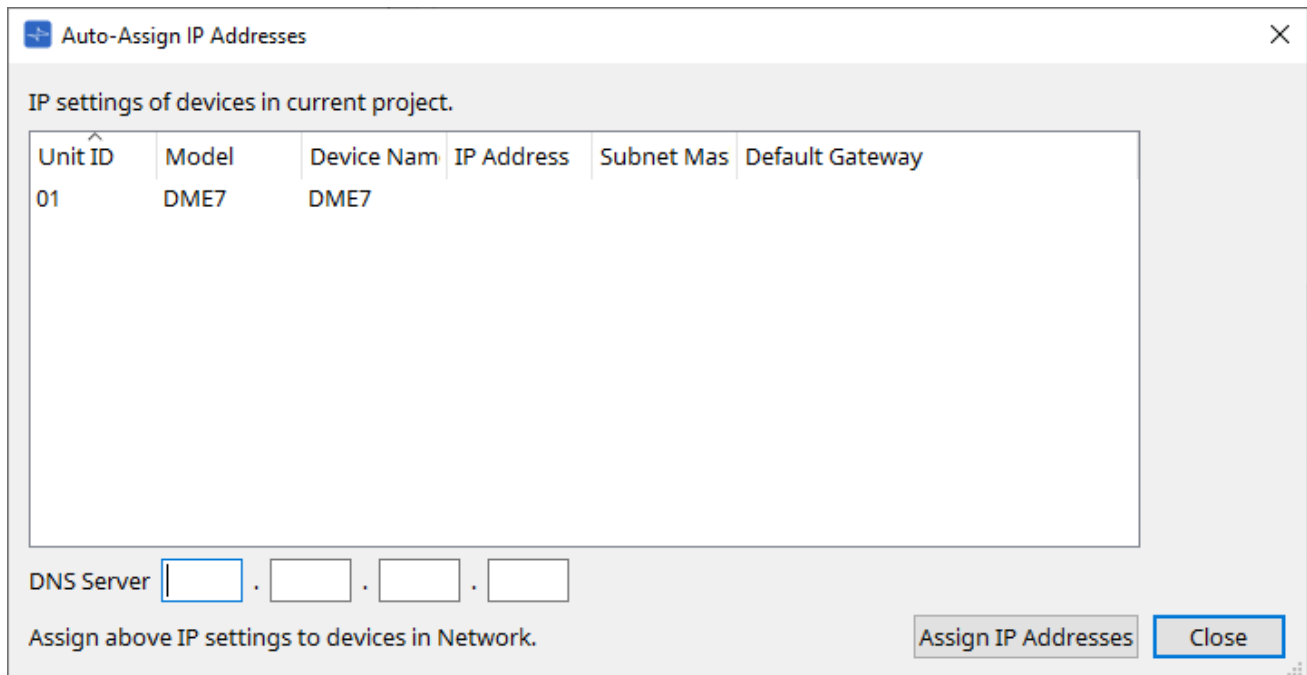

- **Device list**  
Shows the devices for assignment and the IP settings to be assigned.
- **DNS Server (PGM1 only)**  
This field is empty by default. Enter the DNS server address.
- **[Assign IP Addresses] button**  
Applies the information shown in the device list to the "IP Address" dialog box. Even if the [DHCP] option button is selected in the "IP Address" dialog box, the [Static IP] option button is switched to the enabled state.
- **[Close] button**  
Closes the dialog box.

## 10.11. "Match Devices by IP Address" dialog box

When you assign an IP address to a virtual device in this dialog box, ProVisionaire Design searches for devices on the network by IP address.

If you want to control a system that is on a different subnet than ProVisionaire Design, make settings here.

For the procedure, refer to ["Settings for controlling devices across subnets"](#).

Dante audio communication is not possible between devices that are on different subnets.

Set the IP addresses so that they are unique for the entire communication path. If devices of the same IP address exist on the communication path, they might not be distinguishable.

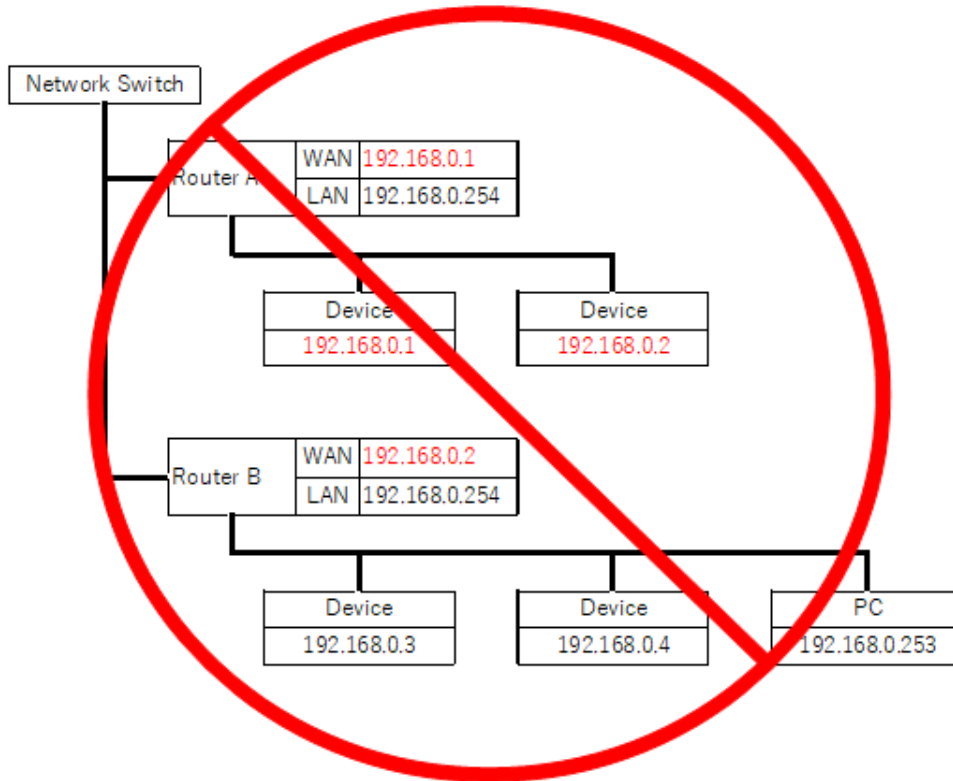



Match Devices by IP Address

Set an IP address for the device (virtual device) added to the project.  
ProVisionaire Design will automatically detect network devices that match the virtual device's IP address.

In the IP Setting dialog window, set the IP address of the network device so that it matches the IP address of the virtual device.  
System Menu> IP Settings> Set IP Address> Auto-Assign IP Address.

IP Address Range Finder

IP Address : 192 . 168 . 10 . 110

Subnet Mask : 255.255.255.0

Find Range

Range : 192.168.10.1 - 192.168.10.254

Default Gateway : 192 . 168 . 10 . 254

Apply IP Address Apply found IP Address Range to the checked devices.

All On All Off All Clear

	Unit ID	Model	Device Name	IP Address	Subnet Mask	Default Gateway
<input type="checkbox"/>	01	DME7	DME7	. . . .	255.255.255.0	. . . .
<input type="checkbox"/>	01	MTX5-D	MTX5-D	. . . .	255.255.255.0	. . . .

OK Cancel

- **IP Address Range Finder**

This section enables you to calculate the range of IP addresses that can be assigned.

- **[IP Address]**  
Enter the IP address that you want to use.
- **[Subnet Mask]**  
Select the subnet mask.
- **[Find Range] button**  
When you click this, the range that can be specified is calculated from the IP address and subnet mask that you input.
- **[Range]**  
Shows the calculated range of IP addresses.
- **[Default Gateway]**  
Shows the calculated default gateway.
- **[Apply IP Address] button**  
When you click this, the IP address calculated in "IP Address Range Finder" and the default gateway are applied to the devices in the device list.
- **[All On] button**  
Selects all devices in the device list to be affected by [Apply IP Address].
- **[All Off] button**  
Deselects all devices in the device list from being affected by [Apply IP Address].
- **[All Clear] button**  
Deletes the IP address information of the devices.
- **Device list**  
Here you can view and edit the settings of the devices in the device list.
  - **Check box**  
If this is selected, [Apply IP Address] will apply to this device.

- **[IP Address]/[Subnet Mask]/[Default Gateway]**

Here you can view and edit the device's IP address, subnet mask, and default gateway.

- **[OK] button**  
Applies the settings and closes the dialog box.
- **[Cancel] button**  
Discards the settings and closes the dialog box.

## 10.12. "Device Information" dialog box

To open this dialog box, click [Device Information] from the [System] menu on the menu bar. This lists information for the devices on the network, allowing you to update their firmware or restart them.

Unit ID	Model	Device Name	MAC Address	Serial No.	Version	Status	Battery
01	DME7	DME7	00:30:64:6A:7C:5C	318	V1.0.0	OFFLINE	---
0A	PC412-DI	PC412-DI	AC:44:F2:6E:AF:07	JEZY01001	V1.0.5	OFFLINE	---

- **Network Interface**

Shows the name/IP address/subnet mask of the network card currently selected in the "Network Setup" dialog box.

- **[Refresh] button**

Searches again for devices on the network. This cannot be clicked while an update is in progress.

- **[Detail>>] button**

Switch this button on to display to the right the information specific to the device that is currently selected on the device list.

- **Device list**

- **Identify button**

When you press this button located at the left of the Unit ID, the indicators of the corresponding device will flash for several seconds.

- **Unit ID / Model / Device Name**

These columns indicate the device Unit ID, device model name, and device name. If there is a UNIT ID conflict, an  indication is shown. To change the device name, use the [Device Name] field in the "Properties" area of the "Project" sheet.



If different types of devices are used, the same Unit ID can be used for them. However, if the MTX series unit is set to Unit ID mode, the IP address will be automatically set to 192.168.0.<Unit ID>.

In this case, you must set unique Unit IDs so that they will not overlap (conflict) among all devices.

- **MAC Address**  
Shows the MAC address that is specified for the device.
- **Serial No.**  
Shows the serial number of the device.
- **Version**  
Shows the firmware version.
- **Status**  
Shows the online or offline status.  
When updating a device, the progress is shown.
- **Battery (MTX series and XMV series units only)**  
Shows the remaining battery capacity of the device.

EMPTY	The remaining amount is 0–0.5V. Immediately stop using the unit, and contact a Yamaha service center.
LOW	The remaining amount is 0.5–2.5V. Contact a Yamaha service center as soon as possible.
OK	The remaining amount is 2.5–3.5V. There is no problem.
N/A	There is no internal battery.

- **[Update Firmware] button**

Updates the firmware. Please note that you can do so only for the online devices. Click this button to open the ["Update Firmware" dialog box](#).

- **[Initialize] button**

Initializes the device. Click this button to open the ["Initialize" dialog box](#).

- **[Reboot] button**

Reboots the device.

- **[Close] button**

Closes the dialog box. This cannot be clicked while an update is in progress.

### 10.12.1. "Detail>>" area

This area displays information specific to the target device.

#### ■ For the DME7

This area displays device information for each Device License that is activated for the device.

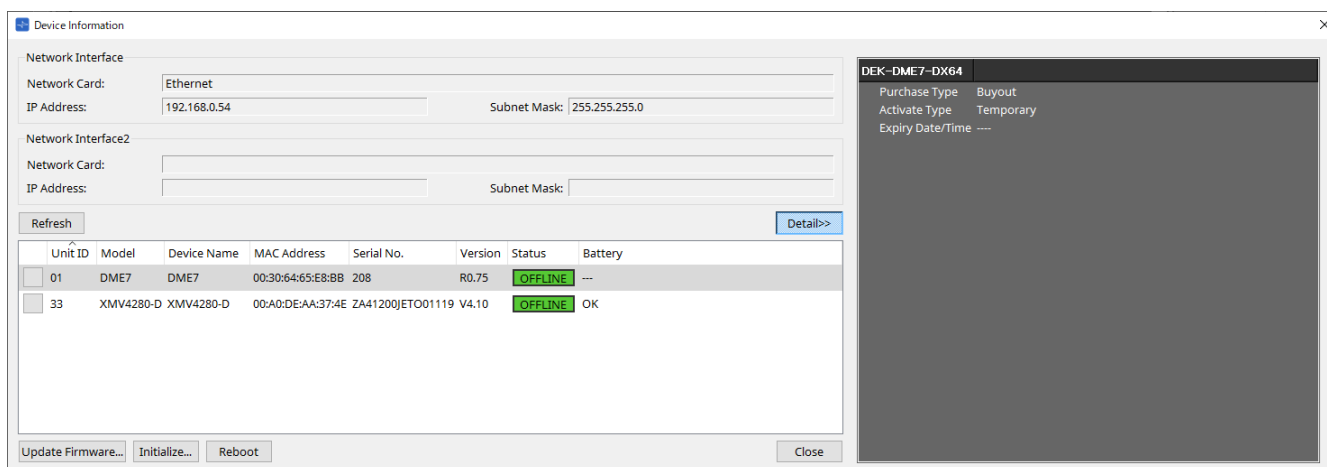

- **Title**

Indicates the license name.

- **Purchase Type**

Indicates "Buyout" or "Trial."

- **Activate Type**

This information appears only if the Purchase Type is "Buyout."

- **Temporary**

With this type, you can activate and deactivate the license.

- **Permanent**

With this type, you cannot deactivate the license.

- **Timed**

With this type, the license features an expiration date.

- **Activate Date/Time**

Indicates the date and time at which you activated the license.

- **Expiry Date/Time**

If the Purchase Type is "Trial" or the Activate Type is "Timed," this field indicates the date and time at which the license expires.

Otherwise, it indicates "---."

For license management, see the "Device License Activation Guide".

## 10.13. "Update Firmware" dialog box

To open this dialog box, click the [Update Firmware] button in the [Device Information] dialog box.

Update the firmware of a supported unit.

For details on how to update the Dante firmware, refer to the "Dante Firmware Update guide" .



The DME7 updates the Dante firmware at the same time as updating the firmware of the unit.

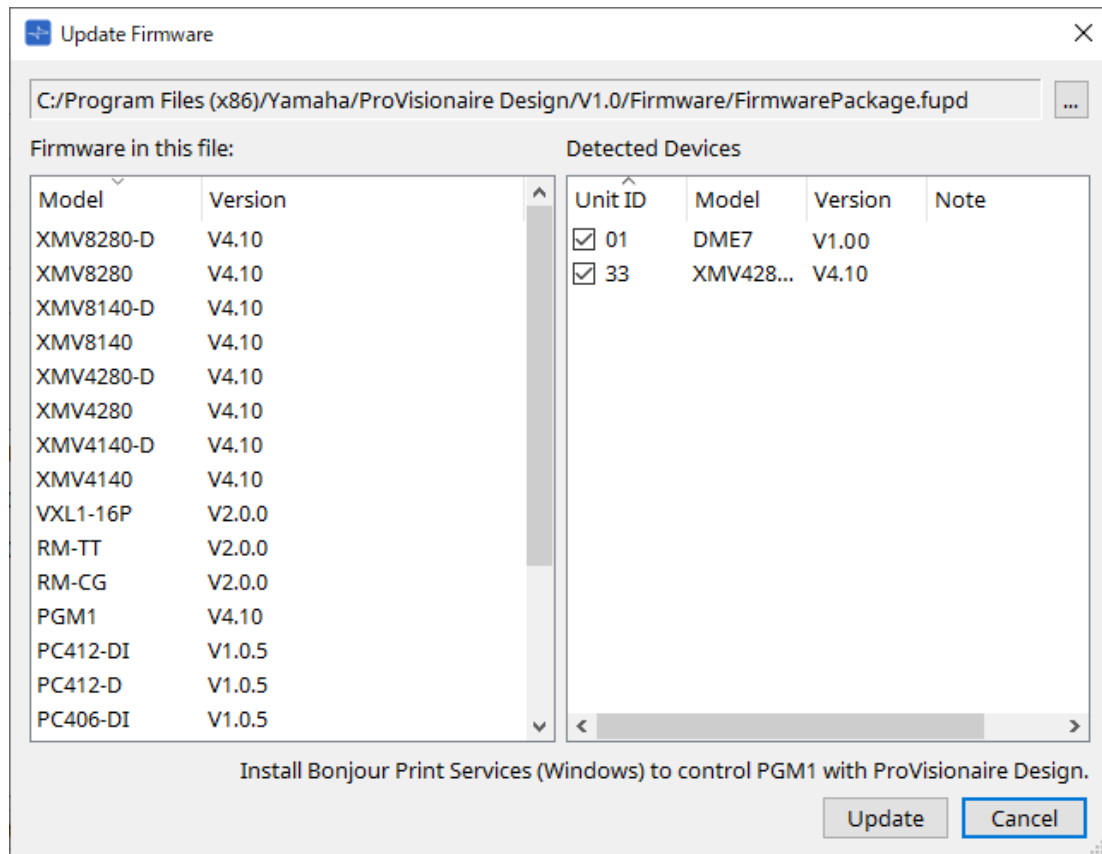

- **Files**

Shows the currently selected update file (.fupd).

- **[...] button**

Click this button to select an update file. Clicking this button opens the "Select Folder" dialog box; select an .fupd file.



When installing ProVisionaire Design, the .fupd file included in the compressed file is also copied to the Program Files (x86) folder. This file is automatically selected when the dialog is opened.

- **Firmware in this file**

Shows the contents of the update file.

- **Detected Devices**

Shows the detected devices.

- **Check boxes**  
Enables you to select a target device to update.
- **Unit ID**  
Indicates the UNIT ID of the device.
- **Type**  
Indicates the model name of the device.

- **Version**

Shows the firmware version of the device.



To control the PGM1 from ProVisionaire Design, you must first install Bonjour Print Services (Windows).

- **[Update] button**

Executes the update.

If a file is not selected, this button will be unavailable and cannot be clicked.

- **[Cancel] button**

Closes the dialog box without updating.



An alert appears if a device incompatible with ProVisionaire Design is detected. Refer to the Yamaha Pro Audio website for information on compatibility between ProVisionaire Design and various devices.

<https://www.yamahaproaudio.com/>



You must be logged in to update your RM series. Please refer to the chapter of RM-CG/RM-TT.

## 10.14. "Initialize" dialog box

To open this dialog box, click the [Initialize] button in the [Device Information] dialog box. This dialog box enables you to initialize the device settings.

Target products include PC series, DME7, RM-CG, and RM-TT.  
Select the tab for the product you wish to initialize.

### ■ For the PC series

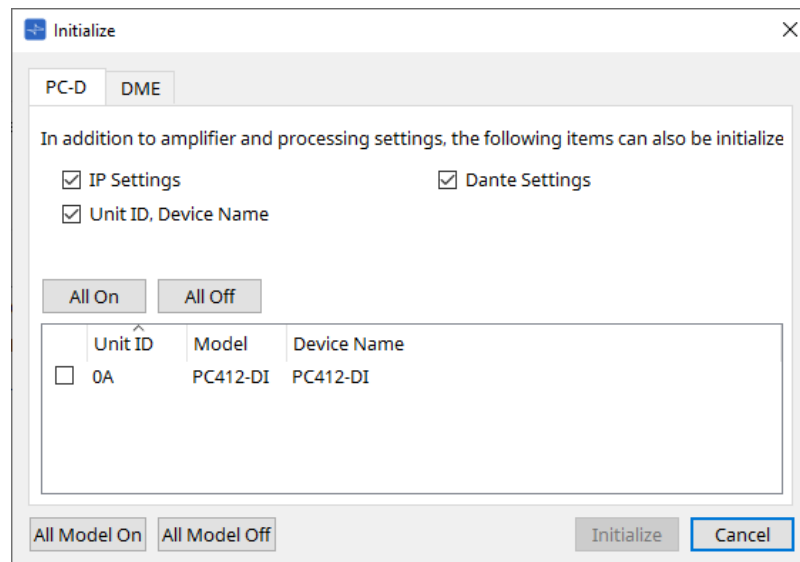

#### • Check boxes

Add a check mark to the check boxes for the items you wish to initialize.

##### ◦ IP Settings

If this item is checked, the device IP settings will also be initialized.

##### ◦ Unit ID, Device Name

If this item is checked, the device's Unit ID and the name will also be initialized.

##### ◦ Dante Settings

If this item is checked, the Dante-related settings for the device will also be initialized.

#### • [All On] button

Adds a check mark to the check boxes for all devices.

#### • [All Off] button

Clears the check mark from the check boxes for all devices.

#### • Check box

Add a check mark to a device that you wish to initialize.

##### ◦ Unit ID / Model / Device Name

These columns indicate the device Unit ID, device model name, and device name.

To change the device name, use the [Device Name] field in the "Properties" area of the "Project" sheet.

#### • [All Model On] button

Adds a check mark to the check boxes for all devices on all tabs.

#### • [All Model Off] button

Clears the check mark from the check boxes for all devices on all tabs.



- **[Initialize] button**

Executes initialization.



The Unit ID and Device Name settings on the Dante device will not be initialized if its “Dante Device Lock” setting is turned on.

- **[Cancel] button**

Closes the dialog box without updating.

- **For the DME7**

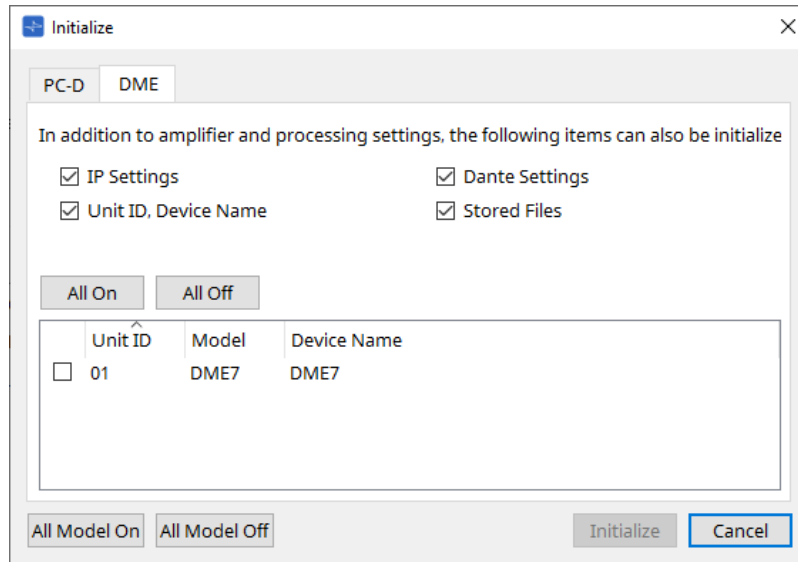

- **Check boxes**

Add a check mark to the check boxes for the items you wish to initialize.

- **IP Settings**

If this item is checked, the device IP settings will also be initialized.

- **Unit ID, Device Name**

If this item is checked, the device’s Unit ID and the name will also be initialized.

- **Dante Settings**

If this item is checked, the Dante-related settings for the device will also be initialized.

- **Stored Files**

If this item is checked, the files saved on the unit using the File Storage function will also be initialized.



Initializing the device does not affect any activated licenses.

## ■ For the RM-CG, RM-TT

The screenshot shows the 'Initialize' dialog box for RM-CG/RM-TT. It features a title bar with a plus icon and a close button. Below the title bar is a tab labeled 'RM-CG/RM-TT'. The main area contains two checked checkboxes: 'Restore all defaults' and 'Network Settings'. Below these are two buttons: 'All On' and 'All Off'. A table with three columns: 'Unit ID', 'Model', and 'Device Name' is shown. The table has one row with a checked checkbox, '01', 'RM-CG', and 'Y001-Yamaha-RM-CG-B49A45'. At the bottom, there are four buttons: 'All Model On', 'All Model Off', 'Initialize', and 'Cancel'.

### • Check boxes

Add a check mark to the check boxes for the items you wish to initialize.

- **Restore all defaults**

If you add a check mark to this check box, all items will be initialized. The “Network Settings” items will also be initialized automatically.

- **Network Settings**

If this item is checked, the network settings for the device will also be initialized.



You must be logged in to initialize the RM series.  
Please refer to the chapter of RM-CG/RM-TT.

## 10.15. "Word Clock" dialog box

To open this dialog box, click [Word Clock] from the [System] menu on the menu bar. This dialog box enables you to modify the word clock settings for the device.

Target models include MTX series, XMV series (excluding Dante models), and DME7 that are added to the project.

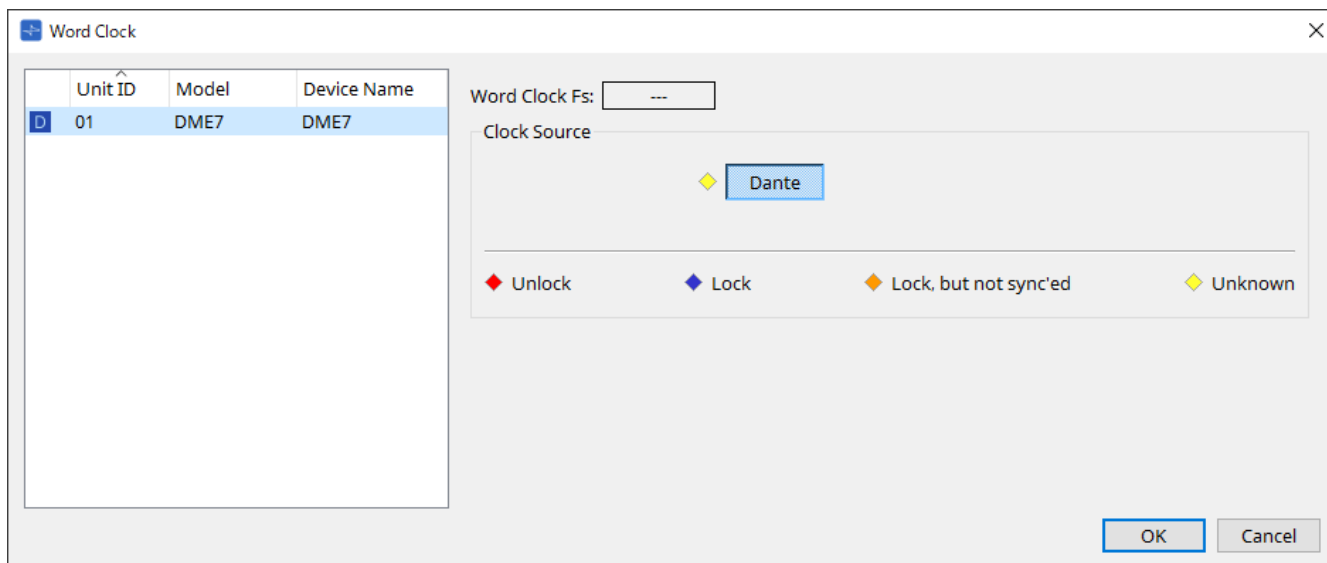

### • [Device] list

This lists the devices whose word clock can be changed. Click the device whose detailed word clock settings you want to edit; the edit screen for that device will appear. The icon at the left of the UNIT ID indicates what is specified as the clock source.

Icon	Clock source
<b>D</b>	Dante
<b>I</b>	Internal
<b>S</b>	Mini-YGDAI card
None	YDIF

### • Word Clock Fs

This indicates the word clock of the device. When online, this indicates the word clock value for the device. When the device is offline, this field indicates "--."

### • Clock Source

Use these buttons to select the word clock source. A indicator showing the status is displayed at the left of buttons that can be selected. When offline the status cannot be detected, so all indicators will be yellow.

- **For the MTX3, XMV**  
You can select one of the internal clocks (44.1 kHz, 48 kHz), or YDIF.
- **For the MRX7-D/MTX5-D**  
You can select Dante, YDIF or Mini-YGDAI Card.
- **For the DME7**  
You can select only Dante.

---

Indicator	Status
◆ Unlock	Unlocked.
◆ Lock	Locked.
◆ Lock, but not sync'ed	Locked but not synchronized.
◆ Unknown	The clock status cannot be detected because an external device is not connected or because there is no valid clock input.

## 10.16. "Protect Devices" dialog box

To open this dialog box, click [Protect Devices] from the [System] menu on the menu bar.

You can specify an Administrator PIN for the device to prevent people other than the administrator from modifying the device settings. If you set an Administrator PIN, you will be required to enter the Administrator PIN when you try to make an online connection between the device and ProVisonaire Design or to specify various device settings. Please be aware that if you forget the Administrator PIN, you will be unable to modify device settings.

Unit ID	Model	Device Name	Administrator PIN

Administrator PIN

Protect device with Administrator PIN.  
Authentication by Administrator PIN required to change device settings.

No PIN required to change device settings.

OK Cancel

- **[Device] list**

This area lists devices for which protection via the Administrator PIN has been canceled or for which an Administrator PIN has not yet been set.

- **Unit ID / Model / Device Name**

These columns indicate the device Unit ID, device model name, and device name.

To change the device name, use the [Device Name] field in the "Properties" area of the "Project" sheet.

- **Administrator PIN**

Indicate the Administrator pin in which devices that have unlocked the PIN.

- **[Administrator PIN] text box**

In this field, enter the Administrator PIN for the device. (The code should be six alphanumeric characters drawn from numbers 0 through 9 and letters a, b, c, d, e, and f. The code is not case sensitive. A blank PIN cannot be specified.)

- **[Protect device with Administrator PIN.] option button**

If you try to change the device settings, you will be required to enter the PIN.

- **[No PIN required to change device settings.] option button**

Cancels device protection via the Administrator PIN.

- **[OK] button**

Sends the protection settings to the device.

- **[Cancel] button**

Discards the settings and closes the dialog box.

## 10.17. "Clock" dialog box

To open this dialog box, click [Clock] from the [System] menu on the menu bar.

The internal clocks for all connected devices are automatically updated to match the date and time on the computer each time the devices come online.

If you transmit the computer's date and time information from this dialog box, the date and time will be updated on any unit that is connected to the same network, regardless of its online/offline status.

### 10.17.1. RM Series

This section applies to the settings for the RM series units.

Unit ID	Model	Device Name	Time Zone	NTP Support	DST Start
01	RM-WAP-8	RM-WAP-8	0:00 GMT	---	off

Time Zone: 0:00 GMT

NTP Support

Network Time Server 1:

Network Time Server 2:

Network Time Server 3:

Network Time Server 4:

Enable Daylight Saving Time

Daylight Saving Time start time

Month: January Week: First Day: Sunday Hour: 00:00

Daylight Saving Time end time

Month: January Week: First Day: Sunday Hour: 00:00

Update Now

Close

- **Device list**  
Displays the current device settings.
- **[Time Zone]**  
Specifies the time zone.
- **[NTP Support] check box**  
If this check box is selected, the NTP server is used.
- **[Enable Daylight Saving Time] check box**  
If this check box is selected, the daylight saving time indication will be enabled.

## 10.17.2. Non-RM Series

This section applies to the settings for units that are not part of the RM series.

Unit ID	Model	Device Name	Current Time	Internet Time Server	Host Name	Time Zone
01	MRX7-D	MRX7-D	2023/09/04 11:38:34	off	---	---
01	DME7	DME7	2023/09/04 11:38:31	off	---	(UTC-08:00) Pacific Time (U ...
02	DME7	DME7	2023/09/04 11:38:31	off	---	(UTC-08:00) Pacific Time (U ...
03	MTX5-D	MTX5-D	2023/09/04 11:38:34	off	---	---
53	XMV828...	XMV8280-D	2023/09/04 11:38:34	---	---	---
57	XMV414...	XMV4140-D	2023/09/04 11:38:34	---	---	---

[Time] is sent to devices that do not support Internet Time Server.

Time Zone: (UTC-08:00) Pacific Time (US & Canada)

Time: 2023/09/04 11:38:34

Synchronize with an Internet time server

Host Name: \_\_\_\_\_

IP Address: \_\_\_\_\_ . \_\_\_\_\_ . \_\_\_\_\_ . \_\_\_\_\_

Update Now

Close

- **Device List**

Displays the current device settings.

The settings are sent when ProVisionaire Design and the device are brought online.

- **[Time zone]**

Sets the time zone. The computer's time zone is set by default.

- **[Time]**

Displays the date and time according to the time zone.

- **[Synchronize with an Internet time server] checkbox**

Acquires the time information from the specified time server and updates the device's internal clock. [Time] is sent to devices that do not support a time server.

- **[Host name]**

Sets the host name of the time server.

- **[IP Address]**

Sets the IP address of the time server.





**Notice**

- If you plan to specify an external time server, configure an Internet connection, and in the IP Address dialog box, specify the [DNS server address] and [Default gateway] as appropriate for the connection environment.  
If you specify an external time server, make sure that the server is reliable. If you specify an unreliable server, you may be exposed to certain risks, such as an infection by a computer virus.
- When using ProVisionaire Edge, we recommend disabling the "Synchronize with an Internet time server" option. If it is enabled, the correct time may not be displayed.

- **[Update Now] Button**

Click to update the device settings at the same time.

- **[Close] button**

Closes the dialog box.

## 10.18. "Daylight Saving Time" dialog box

To open this dialog box, click [Daylight Saving Time] from the [System] menu on the menu bar. This specifies the daylight saving time setting of the devices connected to the same network, regardless of their online/offline state.

The target device is the DME7/MTX series.



For RM series units, use the "Clock" dialog box to make the settings.

- **Device List**

Displays the current device status.

- **[Enable Daylight Saving Time] check box**

Daylight saving time will be enabled if this check box is selected.



If the "Automatically adjust daylight saving time" check box is selected in the computer's "Date and Time" settings, you must also select the [Enable Daylight Saving Time] check box in the "Daylight Saving Time" dialog box.

- **Offset**

Specifies the amount of time by which daylight saving time is earlier than standard time.

- **Start time**

Specifies the time when daylight saving time begins.

For example if you set Offset as 01:00 and Start time as 12:00, the clock will be set to 13:00 when the time reaches 12:00 of the day on which daylight saving time begins.

- **End time**

Specifies the time when daylight saving time ends. If this is the same as the start time, select [Same as Start time].

For example if you set Offset as 01:00 and End time as 12:00, the clock will be set to 11:00 when daylight saving time reaches 12:00 on the last day of daylight saving time. If the [Same as Start time] check box is selected, daylight saving time will automatically be cancelled and revert to standard time on the last day of daylight saving time at the time specified by the Start time.

- **Day of the week**

If this is on, the term of daylight saving time will be specified as a day of the week. Use Start and End to specify which day of which week will be the start and end of daylight saving time. For example to specify the first Sunday in April, choose "First," "Sunday," and "April"; to specify the last Sunday in October, choose "Last," "Sunday," and "October."

- **Day**

If this is on, the term of daylight saving time will be specified as a day of a month. Use Start and End to specify the dates that will be the start and end of daylight saving time.

- **[Update Now] button**

When you click this, the device's internal clock is updated according to the settings.

- **[Close] button**

Closes the dialog box.



Events that are assigned within two hours before or after the beginning or end of daylight saving time in the "Scheduler" dialog box will not be executed correctly.

## 10.19. "GPI Calibration" dialog box

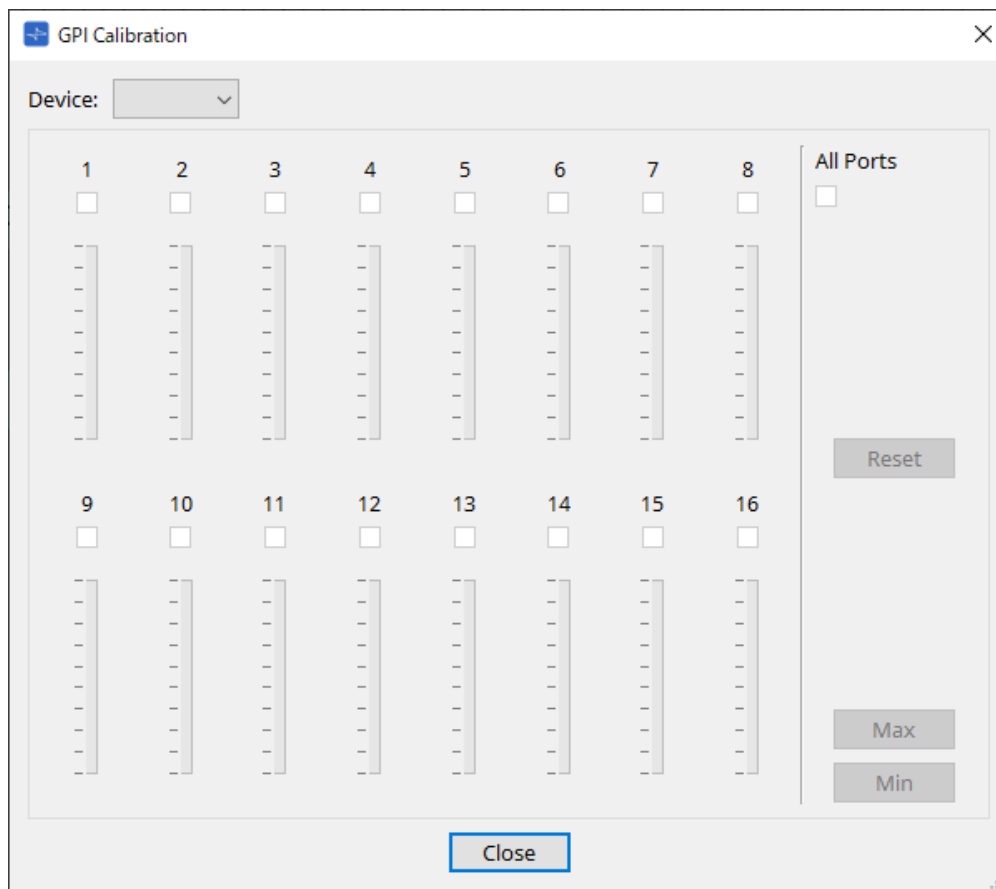

To open this dialog box, click [GPI Calibration] from the [System] menu on the menu bar.

Here you can calibrate the input voltage detection range for the [GPI] connector of the device. Available only when online. These settings adjust the detection range in order to stabilize the input voltage of the [GPI] connector.

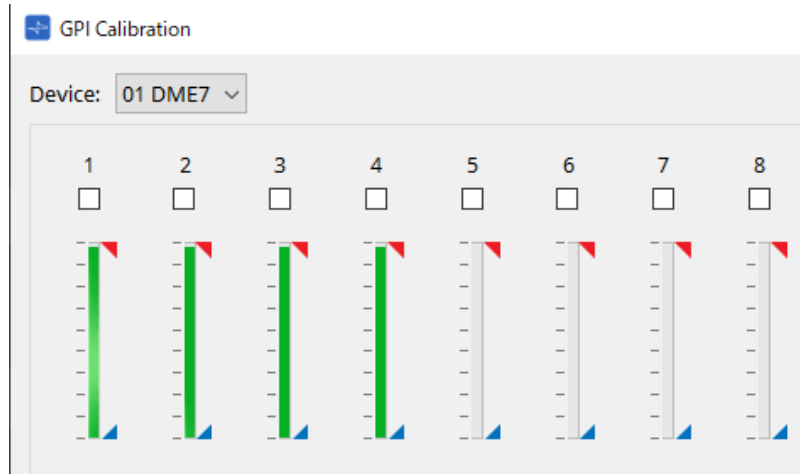

- **[Device:]**  
Enables you to select a target device to calibrate.
- **[All Ports] check box**  
Selects the check boxes of all channels.
- **[Ch] check boxes**  
Calibration will be applied to the channels whose boxes are selected
- **Calibration data**  
The input voltage is shown in real time as a graph.



- **[Reset] button**  
Calibration will be reset for the channels whose boxes are selected.
- **[Max] button**  
Sets the current input voltage of the selected channels to the maximum value. The maximum value you set is shown by .
- **[Min] button**  
Sets the current input voltage of the selected channels to the minimum value. The minimum value you set is shown by .

### Calibration procedure

1. **Connect your external device to the DME7/MTX's [GPI] connector.**
2. **Select the check box of the channel numbers for which you want to perform calibration.**  
If you want to select all channels, select the [All Ports] check box.
3. **To specify the detection range, increase the input from the external device to the maximum and click the [Max] button; then decrease the input to the minimum and click the [Min] button.**  
This lets you specify the optimal detection range as appropriate for voltage drop caused by wiring or due to the specifications of your devices.



- The threshold for on/off switching will be the center value between the maximum and minimum input voltage values (the sum of the maximum value and minimum value, divided by 2). To prevent malfunctions, you should allow plenty of range for detection.
- If the voltage has dropped because of cable length or noise, adjust the maximum and minimum input voltage values. Since voltage may become unstable, configure and set up your external circuit to ensure that there is ample distance between the maximum and minimum values.

## 10.20. "Get Log from Devices" dialog box

To open this dialog box, click [Get Log from Devices] from the [System] menu on the menu bar. A record of the MTX series/XMV system's operation is stored as a "log" in the MTX series/XMV's internal memory. In this dialog box you can output the logs of all MTX series/XMV units existing on the subnet to which your computer is connected, and save them as a file. The log file is in ".csv" format.

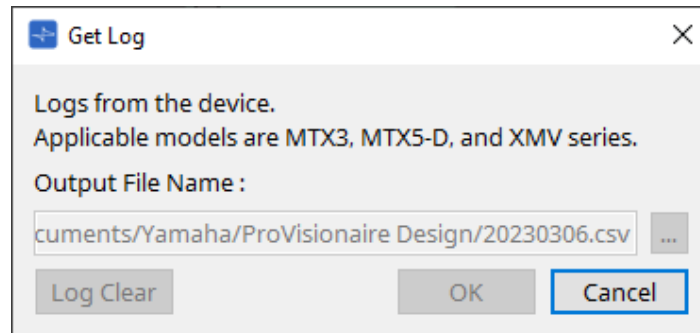

- **[Output File Name:] text box**  
Shows the location (absolute path) in which the log file is saved. You can also enter this directly.
- **[...] button**  
Opens the file browser and selects the file that will be output as the log.
- **[Log Clear] button**  
Deletes the log for all devices existing on the subnet.
- **[OK] button**  
Outputs the log file and closes the dialog box.
- **[Cancel] button**  
Cancels log file output and closes the dialog box.

## 10.21. "RM Series Settings" > "Sign up" dialog box

To open this dialog box, click [RM Series Settings] from the [System] menu on the menu bar, and then click [Sign up...].

This dialog box enables you to set the initial password for an RM series unit.

To control the device from ProVisionaire Design, you must set an initial password.

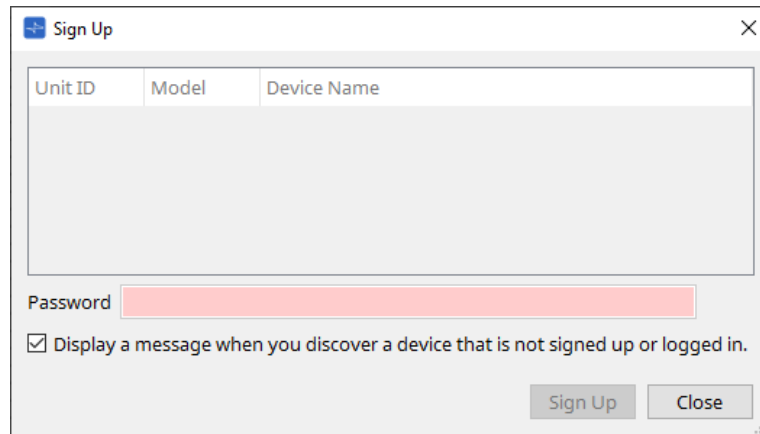

- **Device List**

Displays RM series units on the network for which an initial password has not been set.

- **Unit ID / Model / Device Name**

These columns indicate the device Unit ID, device model name, and device name.

To change the device name, use the [Device Name] field in the "Properties" area of the "Project" sheet.

- **[Password] text box**

Enter a password here (4-16 alphanumeric characters).

- **[Display a message when you discover a device that is not signed up or logged in.] check box**

If this item is checked, and if ProVisionaire Design detects any devices for which the initial password has not been set or any devices that have not signed in, the "Sign Up" or "Login" dialog box will automatically appear.

## 10.22. "RM Series Settings" > "Login" dialog box

To open this dialog box, click [RM Series Settings] from the [System] menu on the menu bar, and then click [Login...].

You must log in to be able to control the devices via ProVisionaire Design.

The screenshot shows a dialog box titled "Login". At the top, there is a "Password" text box. Below it is a table with three columns: "Unit ID", "Model", and "Device Name". Underneath the table, there is a checkbox with the label "Display a message when you discover a device that is not signed up or logged in." At the bottom right, there are two buttons: "Login" and "Close".

- **[Password] text box**  
Enter a password here (4-16 alphanumeric characters).
- **Device List**
  - **Unit ID / Model / Device Name**  
These columns indicate the device Unit ID, device model name, and device name.  
To change the device name, use the [Device Name] field in the "Properties" area of the "Project" sheet.
- **[Display a message when you discover a device that is not signed up or logged in.] check box**  
If this item is checked, and if ProVisionaire Design detects any devices for which the initial password has not been set or any devices that have not signed in, the "Sign Up" or "Login" dialog box will automatically appear.
- **[Login] button**  
Executes log-in and closes the dialog box.
- **[Close] button**  
Cancels log-in and closes the dialog box.



If the "Enable SCP remote control access" setting for a device has been turned off, it will automatically be turned on at the time of log-in.  
To disable this setting, access the [System] menu > RM Series Settings > Enable SCP remote control access.



## 10.23. "RM Series Settings" > "Password Settings" dialog box

To open this dialog box, click [RM Series Settings] from the [System] menu on the menu bar, and then click [Password Settings].

This dialog box enables you to change the password for the devices.

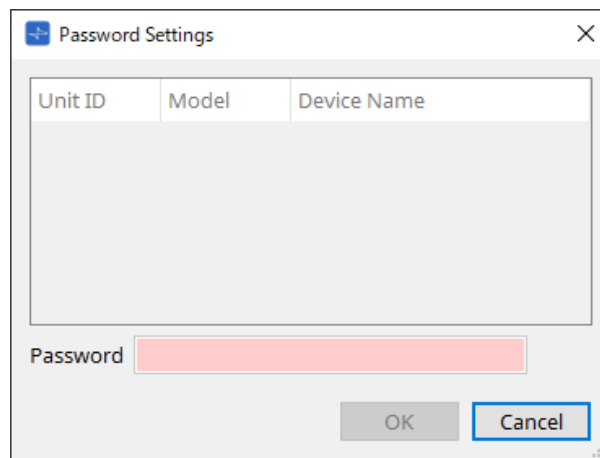

- **Device List**

Displays the logged-in device in the list.

- **Unit ID / Model / Device Name**

These columns indicate the device Unit ID, device model name, and device name.

To change the device name, use the [Device Name] field in the "Properties" area of the "Project" sheet.

- **[Password] text box**

Enter a password here (4-16 alphanumeric characters).

Overwrites the existing password for all the devices with the new password.

- **[OK] button**

Sets the password and closes the dialog box.

- **[Cancel] button**

Discards the modified password and closes the dialog box.

## 10.24. "RM Series Settings" > "Enable SCP remote control access" dialog box

To open this dialog box, click [RM Series Settings] from the [System] menu on the menu bar, and then click [Enable SCP remote control access].

To be able to modify the settings via a controller (such as ProVisionaire Design), you must turn on the "Enable SCP remote control access" setting.

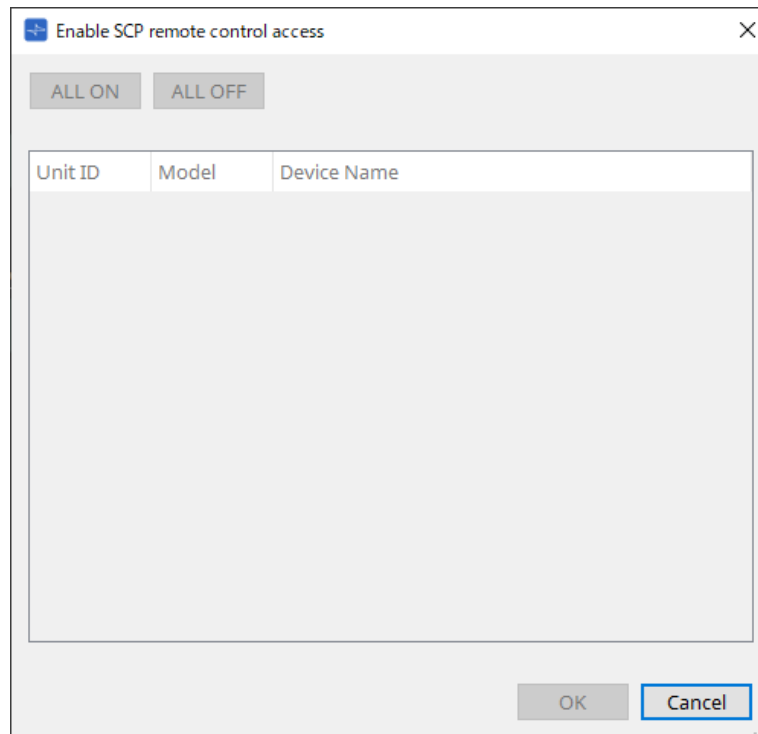

- **Device List**

- **Unit ID / Model / Device Name**

These columns indicate the device Unit ID, device model name, and device name.

To change the device name, use the [Device Name] field in the "Properties" area of the "Project" sheet.

- **[ALL ON] button**

Selects all devices.

- **[ALL OFF] button**

De-selects all devices.

- **Check box**

If you add a check mark to this check box and click the [OK] button, the "Enable SCP remote control access" setting will be enabled.

- **[OK] button**

Enables the setting and closes the dialog box.

- **[Cancel] button**

Discards the setting and closes the dialog box.

## 10.25. "Linked Presets Manager" dialog box

To open this window, click  on the toolbar.

You can store or recall presets and snapshots for each device collectively.

A group of any presets for each device is called a "linked preset."

This dialog box enables you to assign presets on the devices to a linked preset.

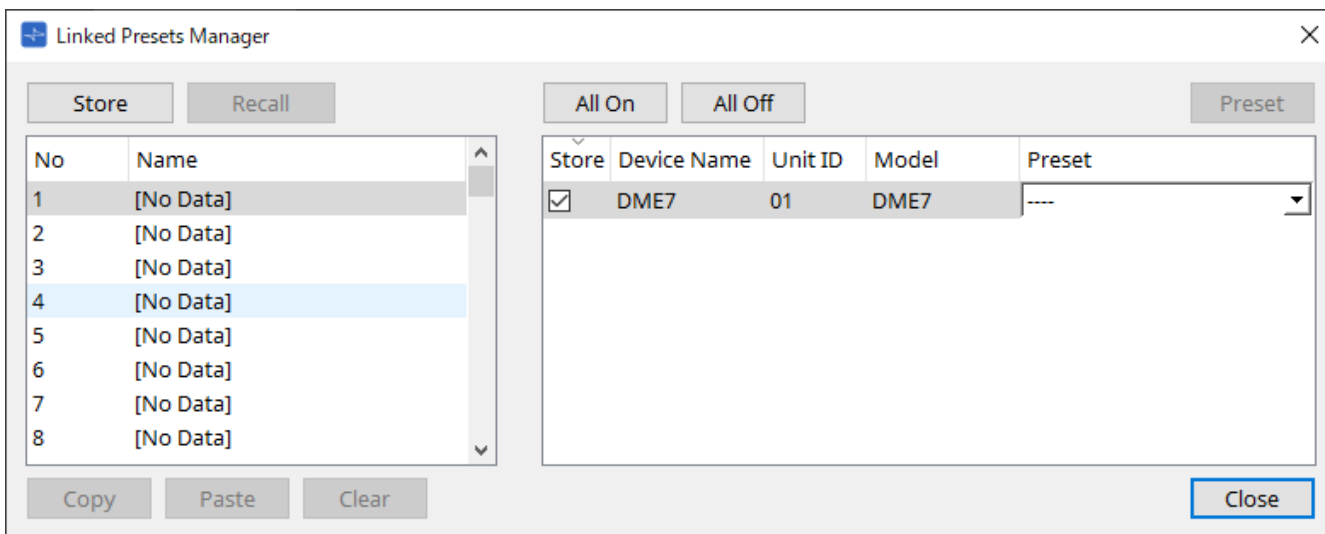

Basic use is as follows.

1. **In the list at left, select the store-destination link preset.**
2. **In the list at right, add a check mark to the devices that you want to store.**
3. **Click the [Store] button.**

The preset is stored in the number you selected in step 1 for each device that you selected in step 2.

To remove a device from being a target of linked presets, select [---] in the [Preset] column of the list at right.

For the DME7, first store a linked preset, and then select a stored snapshot in the "Preset" column.

If you specified presets on each device in advance, use the following procedure.

1. **In the list at left, select the store-destination link preset.**
2. **In the list at right, clear the check box of the device on which a preset has been specified.**
3. **In the list at right, select the [Preset] of the device on which it was already stored.**
4. **Click the [Store] button.**

- **[Store] button**

Store the linked preset. When you store to an empty linked preset, the "Store Linked Preset" dialog box appears.

- **[Recall] button**

Recalls the selected linked preset.

- **Link preset field**

Selects the linked preset to store or recall.

- **[Copy] button**

Copies the selected linked preset.

- **[Paste] button**

Pastes the copied linked preset to the selected linked preset.

- 
- **[Clear] button**  
Erases the selected linked preset.
  - **[All On] button**  
Adds a check mark to the [Store] check box of all devices in the list.
  - **[All Off] button**  
Clears the check mark from the [Store] check box of all devices in the list.
  - **[Preset] button**  
Shows the device sheet of the currently-selected device.
  - **Device list**  
Shows a list of the devices with preset functionality that are registered in the project.
    - **[Store] check box**  
If this check box is selected, the preset selected in the [Preset] list box is overwrite-saved to devices whose [Store] check box is selected in the device list.  
If the [Preset] list box is [---], it is overwrite-saved to the preset of the same number as the linked preset.  
If settings are already stored in the preset number of the device, and that preset number is selected in the [Preset] list box, clear the check mark.
    - **Device Name / Unit ID / Model**  
These columns indicate the device name, device Unit ID, and device model name.  
To change the device name, use the [Device Name] field in the “Properties” area of the “Project” sheet.
    - **[Preset] list box**  
Select the device’s preset that you want to link to the linked preset.  
You can change the preset number after storing. If you want to exclude it from linked preset recall, select [---].
  - **[Close] button**  
Closes the dialog box.
-

## 10.26. "Store Linked Preset" dialog box

In the "Linked Presets Manager" window, click the [Store] button to access this dialog.

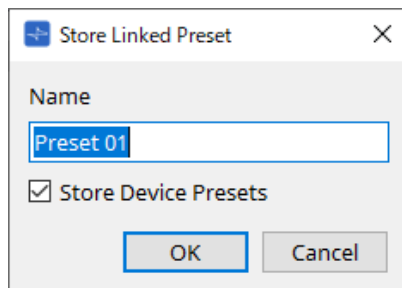

- **[Name] text box**

Enter a name for the linked preset. By default, this will be "Preset + preset number." You can't store if the linked preset name field is empty.

- **[Store Device Presets] check box**

If this check box is cleared, the check box in the list at the right of the "Linked Presets Manager" window is cleared, and the device's preset will not be overwrite-stored.

If you previously stored settings in the device's preset number, clear this check box to prevent overwriting. The settings are stored with the [Store] check box cleared.

- **[OK] button**

Specifies the linked preset and closes the dialog box.

- **[Cancel] button**

Closes the dialog box without specifying the linked preset.

## 10.27. Port Label Dialog

With the port selected, click on the "Label" Value in the Properties area to display it. All port names of the components, including the selected port, can be edited at once.

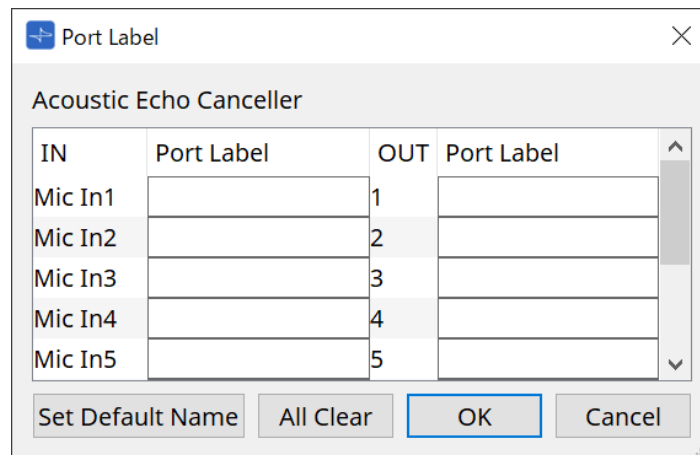

- **Component name**  
The component name containing the selected port is displayed at the top of the list.
- **[IN]/[OUT] Field**  
Displays the default name of the port.
- **[Port Label] Field**  
Displays/edits the port name. Press < Enter > to confirm the input and move the focus to the next port. The focus can also be moved using the cursor keys.
- **[Set Default Name] Button**  
Sets the default name (the name displayed in the [IN]/[OUT] field) in the [Port Label] field.
- **[All Clear] Button**  
Clears all port names.
- **[OK] Button**  
Saves the settings and closes the dialog.
- **[Cancel] Button**  
Closes the dialog without changing the settings.

# 11. Context menus

In some areas, a context menu appears when you right-click.

A context menu does not appear in the "Devices" area, the "Network" area, or the "Bird's Eye" view.

## 11.1. Sheet tabs

The following context menu appears when you right-click a sheet tab.

Menu	Content
[Close]	Closes the sheet.

## 11.2. "Project" sheet

The following context menu appears when you right-click the "Project" sheet.

Menu	Content
[Paste]	Pastes the copied object onto the sheet.
[Select All]	<p>[All] Selects all objects in the sheet. If you want to select the devices in a device group, select the device group and then choose [All].</p> <p>[All Devices] Selects all devices in the sheet. If you want to select the devices in a device group, select the device group and then choose [All Devices].</p> <p>[All Wires] Selects all wires in the sheet. If you want to select the wires in a device group, select the device group and then choose [All Wires].</p> <p>[All Graphics] Selects all graphics in the sheet. If you want to select the graphics in a device group, select the device group and then choose [All Graphics].</p>
[Close All Editor Windows]	Closes all editors.
[Snap to Grid]	If this is checked, objects are placed in alignment with the grid of the sheet.

### 11.2.1. Device in the "Project" sheet

The following context menu appears when you right-click a device in the "Project" sheet.

Menu	Content
[Open Device]	If this item has a check mark, the device's output jacks are shown. This is the same as using the [+] button in the upper left of the device. This menu applies only to power amps.
[Open Device Sheet]	Opens the device sheet of the device. This is the same as double-clicking the device.
[Identify]	Causes the indicators of the device to flash for several seconds.

Menu	Content
[Alert Information]	When executed on a device that is shown in red text, displays the "Alert" dialog box.
[Cut]	Moves the device to the copy buffer.
[Copy]	Copies the amp including its parameter settings.
[Paste]	Duplicates the device in the copy buffer, including its parameter settings.
[Paste Parameters]	If you select an existing device and execute this, the copied device parameters are applied.
[Duplicate]	Duplicates the device including its parameter settings.
[Delete]	Deletes the device.
[Add to Link Group]	Registers the device's channels in a link group.
[Create Device Group]	Registers the selected objects in a device group.
[Bring to Front]	Moves the device display to the foreground.
[Send to Back]	Moves the device display to the background.
[Device Mute]	Mutes the device.

### 11.2.2. Speaker in the "Project" sheet

When you right-click a speaker in the "Project" sheet, the following context menu appears, although menu items may be present or absent depending on the device that is connected.

Menu	Content
[Open Speaker]	If this item has a check mark, the speaker's input jacks are shown. This is the same as using the [+] button in the upper left of the speaker.
[Open Speaker Editor]	Opens the <a href="#">"Speaker Editor"</a> . This is the same as double-clicking the speaker.
[Open Multiple Speaker Editor]	If multiple speakers are selected, this opens the <a href="#">"Multiple Speaker Editor"</a> . If a single speaker is selected, the "Speaker Editor" opens.
[Recall Speaker Preset(s)]	Opens the <a href="#">"Recall Speaker Preset(s)" dialog box</a> .
[Cut]	Moves the speaker to the copy buffer.
[Copy]	Copies the speaker to the copy buffer.
[Paste]	Duplicates the speaker in the copy buffer, including its parameter settings.
[Duplicate]	Duplicates the speaker.
[Delete]	Deletes the speaker.
[Add to Link Group]	If the speaker is connected to an amp, registers the channel of the connected amp.
[Create Device Group]	Registers the selected objects in a device group.
[Bring to Front]	Moves the speaker display to the foreground.



Menu	Content
[Send to Back]	Moves the speaker display to the background.

### 11.2.3. Device group in the "Project" sheet

The following context menu appears when you right-click a device group in the "Project" sheet.

Menu	Content
[Open Group Editor]	Opens the <a href="#">"Group Editor"</a> .
[Cut]	Moves the device group to the copy buffer.
[Copy]	Copies the device group to the copy buffer.
[Paste]	Duplicates the device group in the copy buffer.
[Paste to Device Group]	Duplicates the device group in the copy buffer within the device group.
[Delete]	Deletes the device group.
[Select All]	[All] Selects all objects in the device group.
	[All Devices] Selects all devices in the device group.
	[All Wires] Selects all wires in the device group.
	[All Graphics] Selects all objects in the device group.
[Linked Presets Manager for Group]	Opens the "Linked Presets Manager for Group" window with the devices in the device group as the target. For details, refer to <a href="#">"Linked Presets Manager" dialog box</a> .
[Unpack Device Group]	Cancels the device group.
[Bring to Front]	Moves the device group's display to the foreground.
[Send to Back]	Moves the device group's display to the background.

### 11.2.4. Text, Line, or Polygon in the "Project" sheet

The following context menu appears when you right-click a graphic such as Text, Line, or Polygon in the "Project" sheet.

Menu	Content
[Cut]	Moves the graphic to the copy buffer.
[Copy]	Copies the graphic to the copy buffer.
[Paste]	Duplicates the graphic in the copy buffer.
[Duplicate]	Duplicates the graphic.
[Delete]	Deletes the graphic.

Menu	Content
[Create Device Group]	Registers the selected graphics in a device group.
[Bring to Front]	Moves the graphic display to the foreground.
[Send to Back]	Moves the graphic display to the background.

### 11.2.5. Wire in the "Project" sheet

The following context menu appears when you right-click a wire in the "Project" sheet or a device sheet, although certain menu items may be present or absent.

Menu	Content
[Delete]	Deletes the wire.
[Bring to Front]	Moves the selected wire to the front.
[Send to Back]	Moves the selected wire to the back.
[Insert Node]	Adds a node to the wire.
[Remove Segment]	Deletes the wire segment between nodes.

### 11.2.6. "Network" area

The following context menu appears when you right-click a device.

Menu	Content
[Alert Information]	When executed on a device that is shown in red text, displays the "Alert" dialog box.
[Identify]	Causes the indicators of the device to flash for several seconds.
[Sign Up] (RM series only)	Opens the "RM Series Settings > Sign up" dialog box.
[Login] (RM series only)	Opens the "RM Series Settings > Log In" dialog box.

## 11.3. Device sheet

### 11.3.1. Components and component editors in the device sheet

When you right-click somewhere other than on a component's controller, or on a component, the following context menu appears (not all items are shown for all components).

Menu	Content
[Open Component Editor]	Opens the component editor.
[Copy]	Copies the parameter settings of the component editor.
[Paste Parameters]	Applies the copied parameter settings of the component editor.

## 12. Common operations for device sheets

The following operations are common to device sheets.

### 12.1. Component editor operations

To open the component editor, double-click or right-click a component in the device sheet, and choose [Open Component Editor].

For details on the context menus, refer to "[Context Menus](#)".

If you want to switch between component editors within a single window, click the recycle symbol (🔄) in the lower right of the component editor to make it turn green (🟢). If you open another component editor, the display of the component editor in the foreground will change.

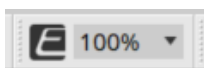

You can adjust the magnification ratio for Editor. Choose from 50, 75, 100, 150, and 200.

If the recycle symbol is gray	If the recycle symbol is green

## 12.2. Editing the parameters

Here we explain how to edit parameters in the component editor.

### • Knobs

There are several ways to edit a knob parameter.

- Select the knob, hold down the left mouse button, and move the mouse cursor up or down.
- Select the knob and turn the mouse wheel.
- Select the numeric display area, hold down the left mouse button, and move the mouse cursor up or down.
- Select the numeric display area and turn the mouse wheel.
- Double-click the numeric display area and directly enter a numeric value.
- Use < Alt >+click to set the nominal value.



### • Sliders

There are several ways to edit slider parameters such as faders.

- Drag the slider's controller.
- Select the slider's controller, and turn the mouse wheel inside the frame.
- Select the numeric display area, hold down the left mouse button, and move the mouse cursor up or down.
- Select the numeric display area and turn the mouse wheel.
- Double-click the numeric display area and directly enter a numeric value.
- Use < Alt >+click to set the nominal value.

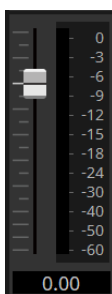

### • Buttons

The parameter of a button changes when you click the button.

There are several types of buttons. The color of the illumination differs depending on the function.

#### Switching a function between enabled and disabled

The button is lit when the function is enabled.



#### Making a mutually exclusive selection

In a set of multiple buttons, enabling one button disables all other buttons.



### Opening a parameter setting window or another component editor

Click the button to open a parameter setting window or another component editor.

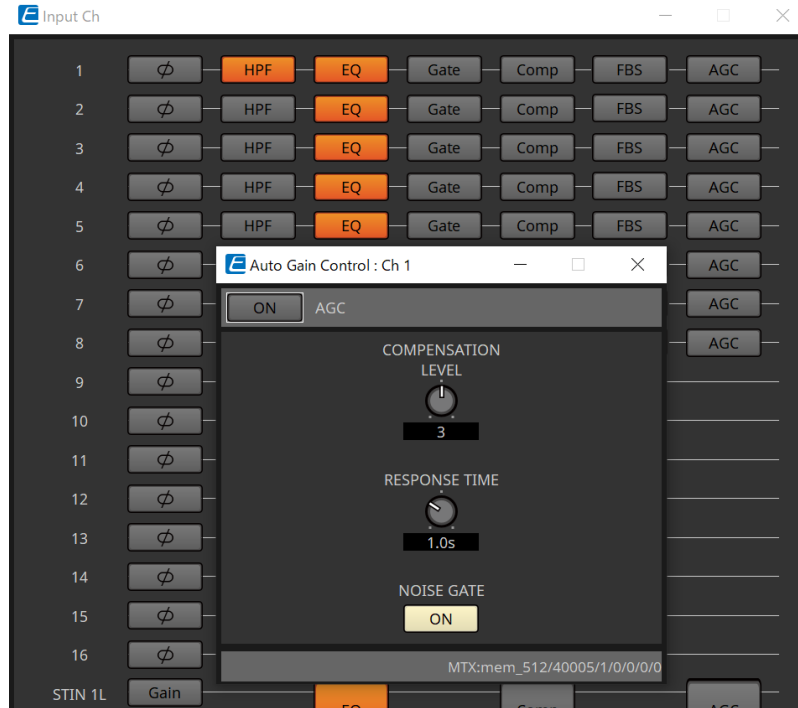

### Displaying a menu

Click the button to access a menu.

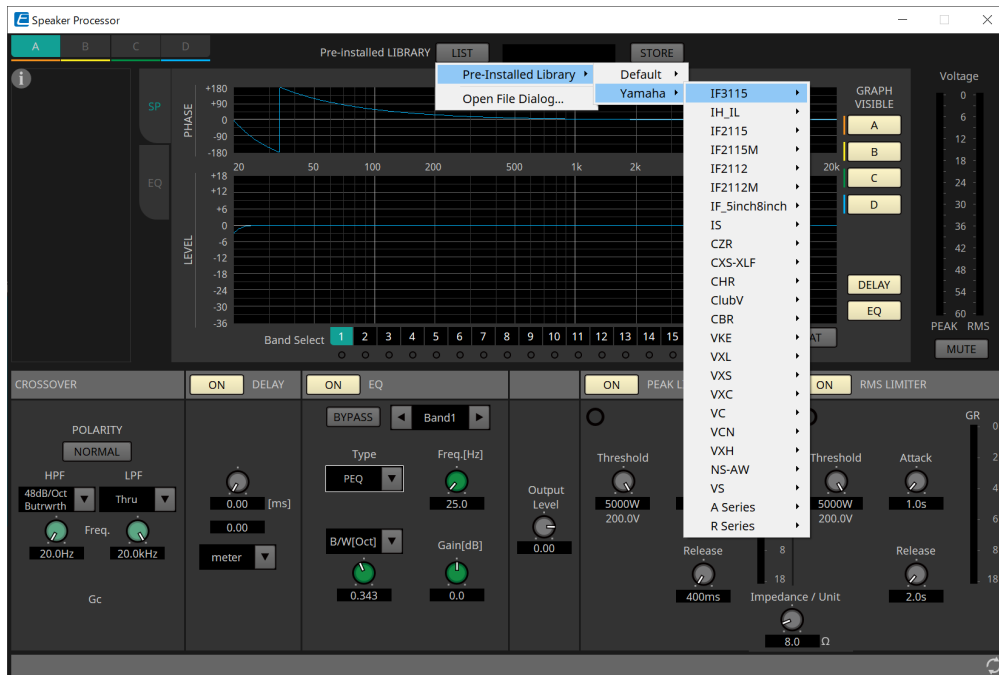

## 12.3. Registering parameters to ProVisionaire Control

You can register the device parameters, snapshots and presets stored in ProVisionaire Design to ProVisionaire Control.

Registration source	Registration method
Component editor	While pressing and holding down < Ctrl >, drag and drop a parameter to a page in ProVisionaire Control.
"Parameters" area	Drag and drop a parameter to a page in ProVisionaire Control.
"Preset" Area/"Parameter Sets" Area	Drag and drop the preset/snapshot/snapshot group* to the ProVisionaire Control page. *Snapshot group is a function of the MRX7-D only.
Link Control editor	While holding the < Ctrl > key down, drag and drop Link Control into the ProVisionaire Control page. *This is a function of the MRX7-D only.

# 13. Audio Processors: DME7

## 13.1. Overview

The DME7 is a freely configurable processor that allows you to place components as desired to freely design a system.

The DME7 can be operated from an external controller such as DCP/MCP1.

In the device sheet of DME7, your workflow consists of freely placing [Components](#) and then [Compile](#) the result. Then, in communication with the DME7 unit, you'll use the [Component editor](#) to edit the parameters.

The Trace Signal Path function allows the signal path to be displayed ([signal path display](#)).

By using the Duplicate Port Label function, you the name of the starting port can be successively duplicated along the signal path ([input port name duplication](#)).

Parameters are stored/recalled in the form of [Snapshot](#).

Multiple parameters that you want to store/recall can be grouped ([Parameter Sets](#)), and 100 sets of parameter values can be stored for each parameter set as snapshots.

Snapshots can also be recalled from a remote controller.

The initial values of a component, together with data that specifies the wiring between components, can be saved on a computer as a [User style](#). By saving a user style, don't have to change the settings each time you place a component. User styles can also be transferred to another computer.

Components and the wires between components can be encapsulated as a [User Defined Block](#). By encapsulating multiple components as a single block, you can make the sheet look cleaner, or copy blocks to easily create the same functionality for other channels. By specifying "View Only" mode or "Protect" mode for individual blocks, you can protect blocks when "[Protect User Defined Block](#)" is executed.

## 13.2. "Project" sheet

You can place devices in this sheet. The following "Settings" dialog box appears when you try to place a device.

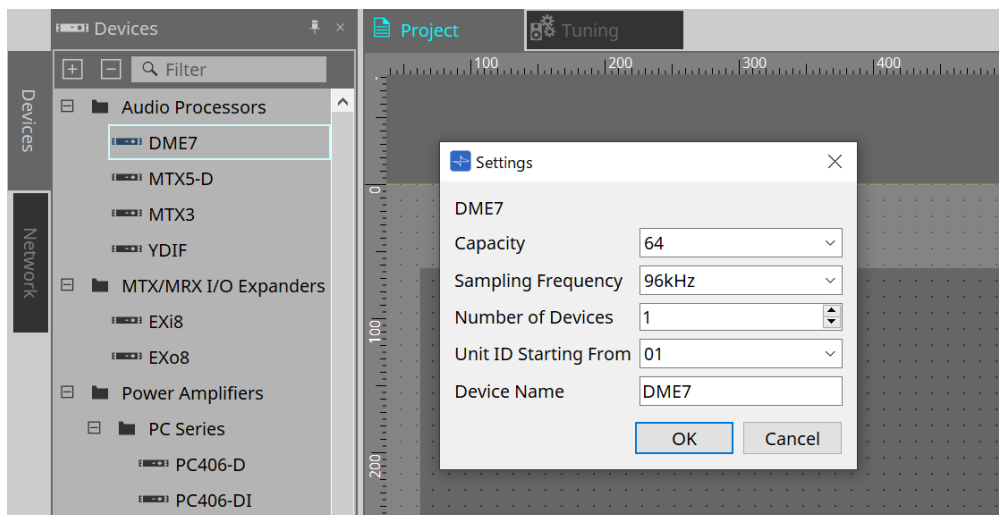

- **Capacity**  
Specifies the signal processing capacity of the DME7. Select from 64, 128, 192, and 256. This capacity must match that of the DME7 unit.
- **Sampling Frequency**  
Specifies the sampling rate for the device. Select from 44.1kHz, 48kHz, 88.2kHz, and 96kHz.
- **Number of Devices**  
Selects the number of DME7 units to be placed in the "Device" sheet.

- **Unit ID Starting From**  
Specifies the device Unit ID number to start with.
- **Device Name**  
Enables you to view and edit the device name.

### 13.2.1. Tool bar

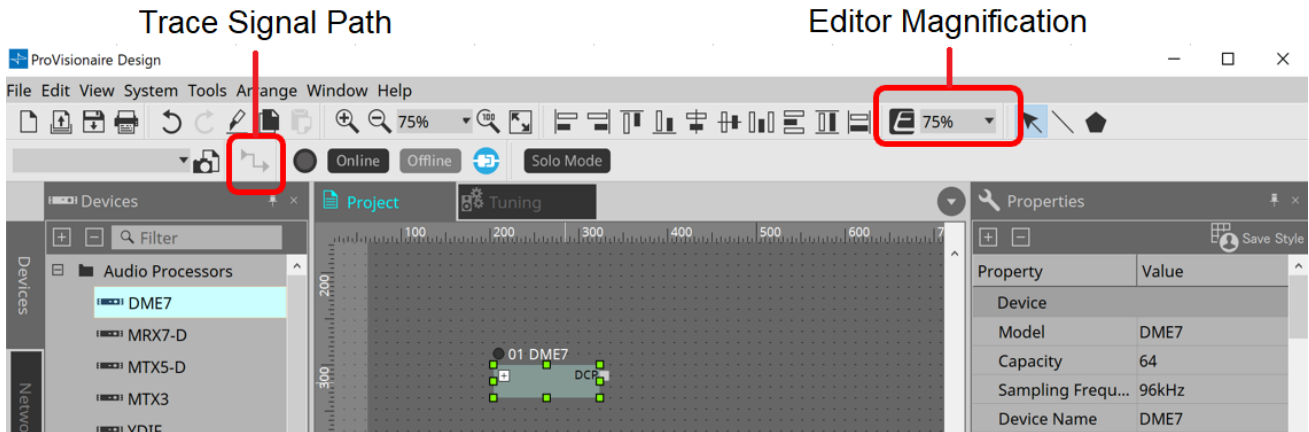

- **Editor Magnification**  
Enables you to modify the magnification ratio for the component editor.
- **Trace Signal Path**  
If you select a port or wire while this command is turned on, the signal path will be traced starting with the selected point as the origin and display flashing lines connecting to the input and output.



## 13.2.2. "Properties" area

This area enables you to view and edit the information on the DME7.

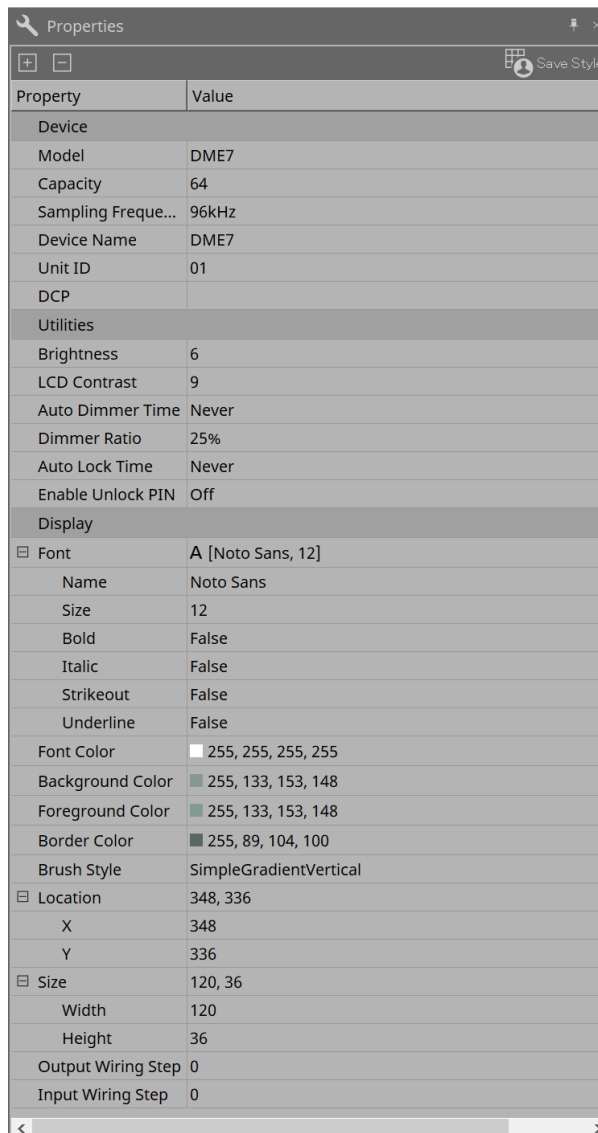

Property	Value
<b>Device</b>	
Model	DME7
Capacity	64
Sampling Freque...	96kHz
Device Name	DME7
Unit ID	01
DCP	
<b>Utilities</b>	
Brightness	6
LCD Contrast	9
Auto Dimmer Time	Never
Dimmer Ratio	25%
Auto Lock Time	Never
Enable Unlock PIN	Off
<b>Display</b>	
Font	A [Noto Sans, 12]
Name	Noto Sans
Size	12
Bold	False
Italic	False
Strikeout	False
Underline	False
Font Color	255, 255, 255, 255
Background Color	255, 133, 153, 148
Foreground Color	255, 133, 153, 148
Border Color	255, 89, 104, 100
Brush Style	SimpleGradientVertical
Location	348, 336
X	348
Y	336
Size	120, 36
Width	120
Height	36
Output Wiring Step	0
Input Wiring Step	0

### • Device

#### ◦ Capacity

Specifies the signal processing capacity of the DME7. Select from 64, 128, 192, and 256.

This capacity must match that of the DME7 unit.

The factory default setting for the capacity of the DME7 unit is 64. If the capacity is 64, the maximum number of available inputs and outputs for Dante, and for Matrix Mixer and Router components, is 64-in/64-out.

Each time you add a license (DEK-DME7-DX64), the number of inputs and outputs for Dante, and for Matrix Mixer and Router components, will increase by 64 channels.

You can add up to three licenses. Refer to the "Device License Activation Guide" for more information on how to add a license to the device.

#### ◦ Sampling Frequency

Specifies the sampling rate for the device. Select from 44.1kHz, 48kHz, 88.2kHz, and 96kHz.

This rate must match the sampling rate for Dante.

#### ◦ Unit ID

This value must match the Unit ID for the DME7 unit. The factory default setting is 1.

- **DCP**

Select a DCP (Digital Control Panel) to connect to the DCP port on the DME7. If you select a DCP, the DCP component will be added to the “Device” sheet.

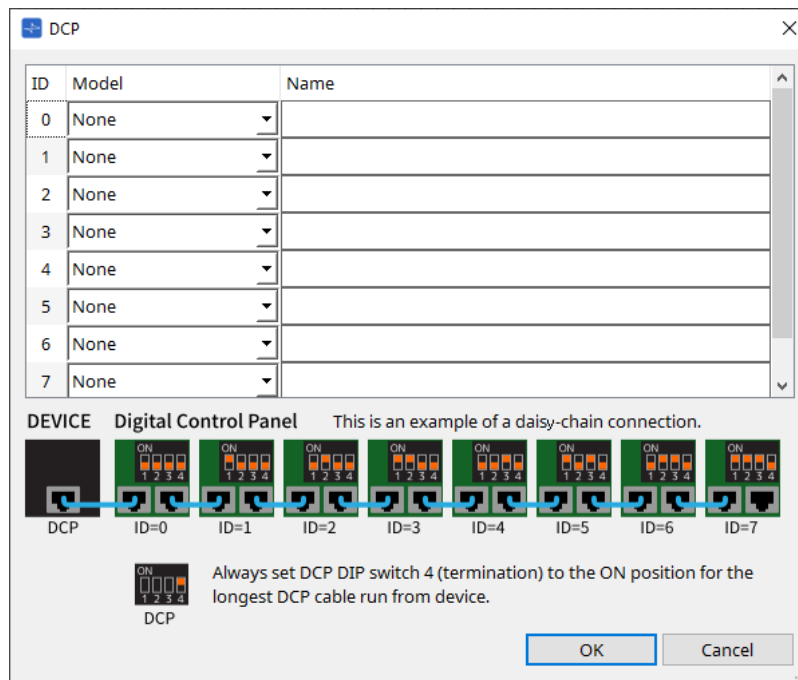

Refer to the [DCP](#) section for details.

For the rest of the items, refer to the description that appears when the corresponding items are selected in the “Properties” area.

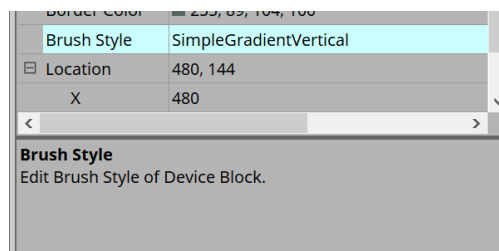

## 13.3. Device sheet screen configuration

Device sheet consists of a menu bar, tool buttons, “Components” area, “Parameter Sets” area, design sheet, “Properties” area, “Parameters” area, and “Bird’s Eye” view.

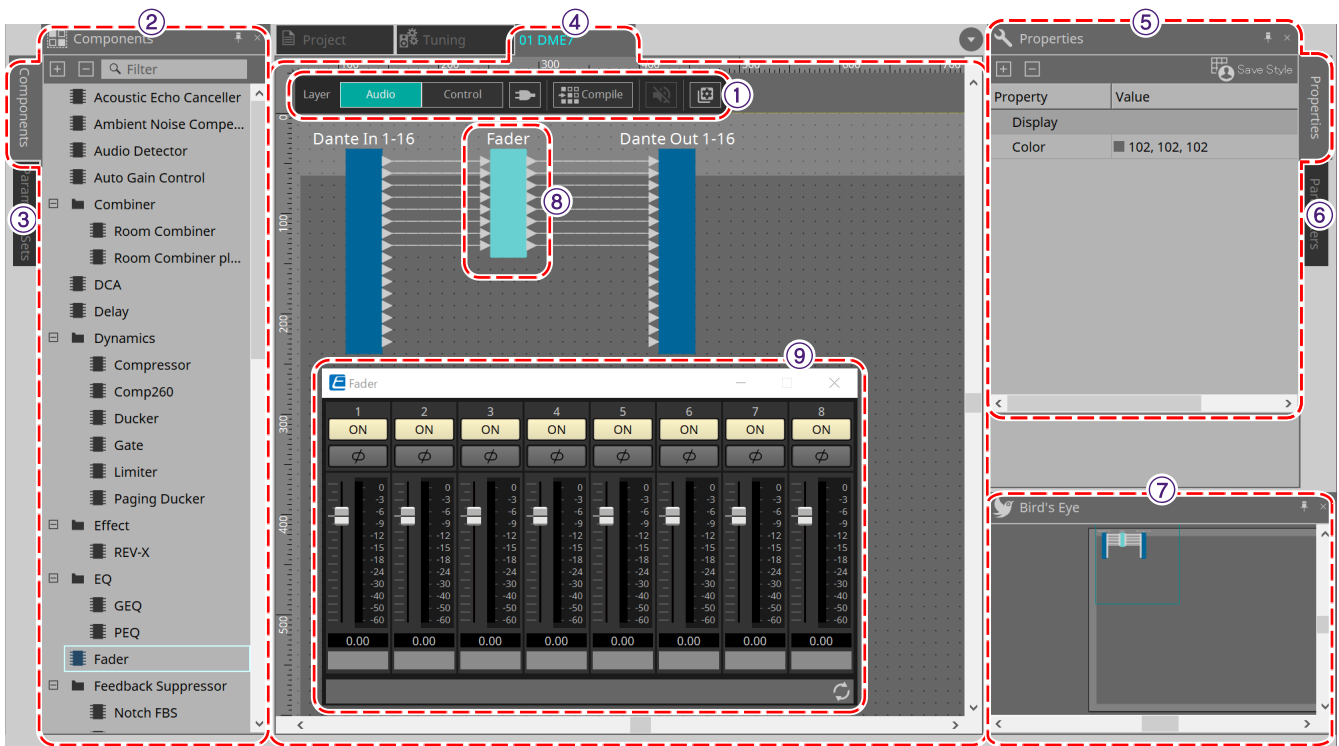

### ① Tool buttons

Frequently-used commands are provided here as buttons ([Tool buttons](#)).

### ② “Components” area

Lists components for the Audio layer and Control layer respectively ([“Components” area](#)).

### ③ “Parameter Sets” area

Enable you to configure parameter sets or snapshots ([“Parameter Sets” area](#)).

### ④ Design sheet

In this sheet you can place and connect components ([Design sheet](#)).

### ⑤ “Properties” area

Enables you to modify the settings for the currently-selected component, port, or wire ([“Properties” area](#)).

### ⑥ “Parameters” area

Lists components that have been placed in the “Design” sheet (Audio layer or Control layer), and their parameters ([“Parameters” area](#)).

### ⑦ “Bird’s Eye” view

This shows an overview of the sheet.

### ⑧ Component

Various signal processing modules, such as an equalizer or compressor, are called “components.”

### ⑨ Component editor

Use the component editor to specify the parameters.

## 13.4. Basic use of ProVisonaire Designer

1. From the “Components” area at the left, drag the component that you want to use and drop it on the design sheet.

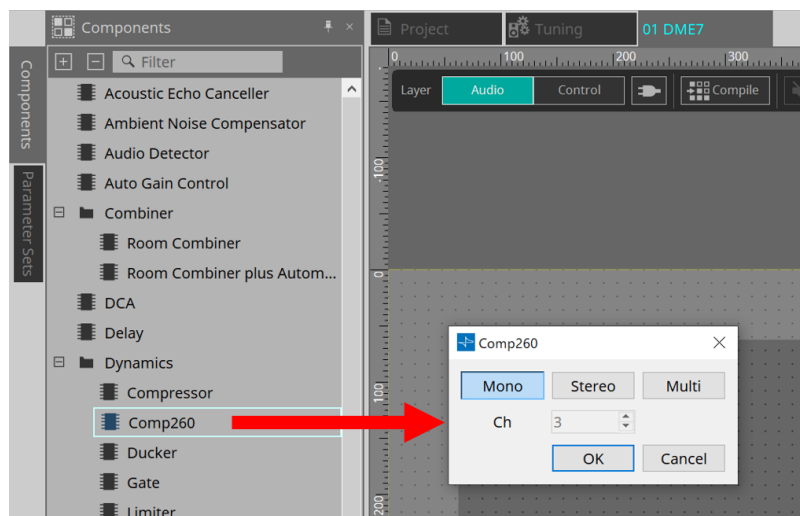

If you drop a component that has multiple candidates such as channels, the candidates are displayed; select the one that you want to use as necessary.



Double-click on a component in the “Components” area to select Stamp mode; in this mode, components are placed successively each time you click the design sheet. To cancel Stamp mode, press < Esc > or click any component in the list.

2. To make a connection, drag the  of a component and drop it on the  of another component. For details, refer to [Connecting ports](#).

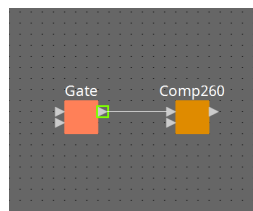

3. Double-click a component or right-click it and choose “Open Component Editor”; the component editor opens, allowing you to operate the parameters.

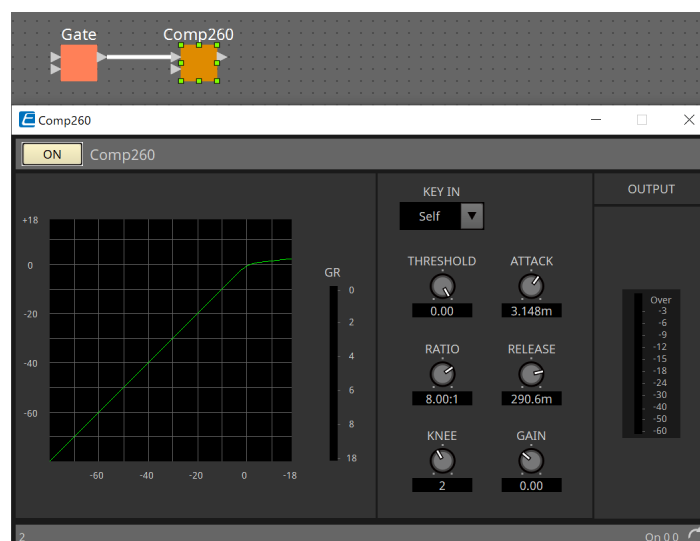

4. **When you have made the necessary settings, click the “Compile” button to check whether there are any problems with the placement and connections of the component.**

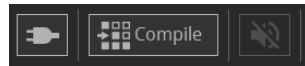

## 13.5. Tool buttons

Commands frequently used in DME7 are provided as buttons.

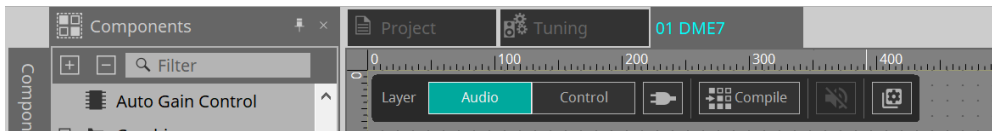

Button	Command	Summary
	[Layer]	Switch between the Audio layer and Control layer. Alternatively, you can do so by using the shortcut keys (Ctrl+page up).
	[Control Function]	Turn this button on to emulate the configuration in the Control layer. While the button is turned on, you cannot modify the configuration.
	[Compile]	Analyzes whether there is any problem with the component placement and wiring.
	[Device Mute]	Mutes the DME7.
	[Tools]	<p><b>[Remote Control Setup List]</b> Enables you to register parameters you wish to control from the remote controller.</p> <p><b>[SD Card File Manager]</b> Enables you to register files you wish to play on the SD Card component.</p> <p><b>[GPI]</b> Using the GPI ins/outs enables you to remotely control the DME7 from a custom-made controller or external device.</p> <p><b>[MIDI]</b> You can remotely control the DME7 via MIDI.</p> <p><b>[MCP1]</b> Opens the MCP1 editor that was placed on the Project sheet.</p> <p><b>[Peak Hold]</b> Select "On" to hold the peak value on the meter for the component placed in the sheet. Select "Reset" to reset the peak hold.</p> <p><b>[Protect User Defined Block]</b> Opens the "Protect User Defined Block" dialog box. For details, refer to the "<a href="#">Protect User Defined Block.</a>"</p> <p><b>[Layer Link]</b> Turn this command on to synchronize (link) the position of the audio component placement between the Audio layer and Control layer.</p>

## 13.6. "Components" area

Components are available for the Audio layer and Control layer respectively.

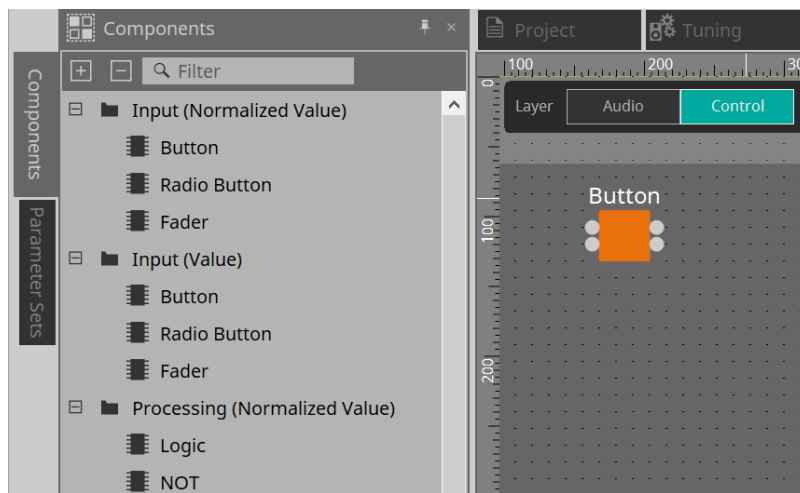
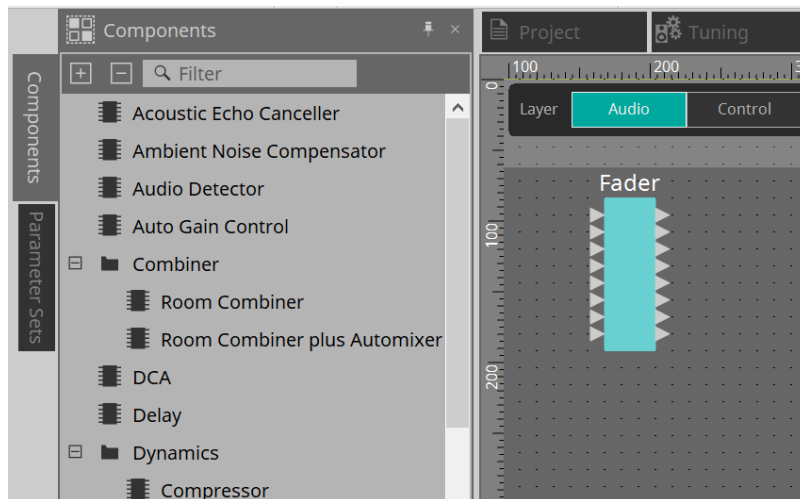

For details on components, refer to the ["ProVisionaire Design DME7 Component Guide"](#).

## 13.7. Design sheet

Here you can place components and connect them.

Parameter settings are the main operations that you can perform while online. Operations such as placing and connecting components can only be done while offline.

### 13.7.1. Placing components

Here we explain how to place components on the design sheet.



If any component in the “Components” area is selected, pressing an alphabetical key will select the component of the matching initial letter.

#### • Placing a single component

Drag a component from the list in the “Components” area and drop it on the design sheet.

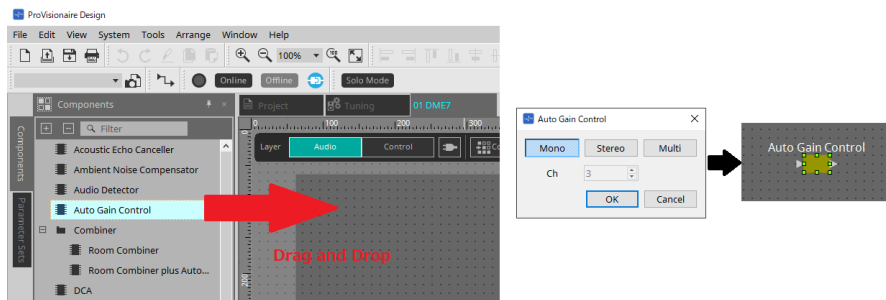

#### • Placing multiple instances of the same component

Double-click on a component in the “Components” area to select Stamp mode; in this mode, the component is placed each time you click the design sheet. To cancel Stamp mode, press < Esc > or click any component in the list.

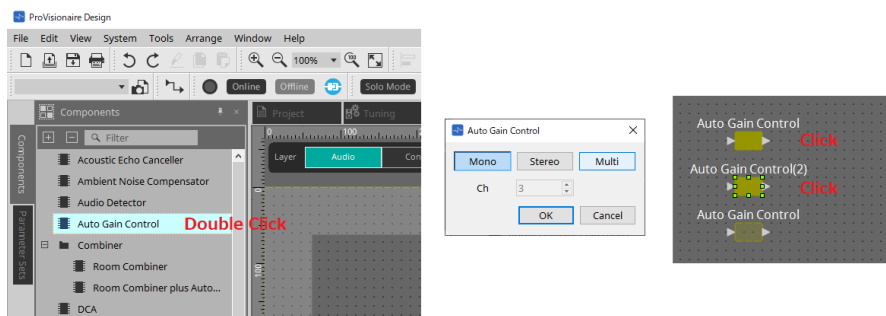

#### • Changing the number of channels for a component you placed

In the “Properties” area, click the property Form field; then click the [...] that appears and select the desired number of channels. This cannot be changed on a component for which [...] is not shown.

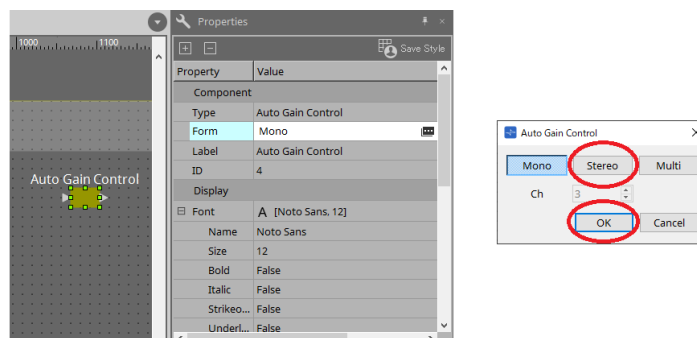



## 13.7.2. Selecting multiple components, ports, or wires

Here's how to select multiple components placed in the design sheet, or multiple wires that connect ports of components.

- **Use the mouse cursor to completely enclose objects**

Drag the mouse cursor to select the components, component ports, wires, and text that are completely enclosed by the rectangular area in the design sheet.



If the selection encloses an expanded User Defined Block, and the point at which you start dragging is on the style sheet, then the objects on the style sheet are selected. If the point at which you start dragging is on a User Defined Block, then objects on the User Defined Block are selected.

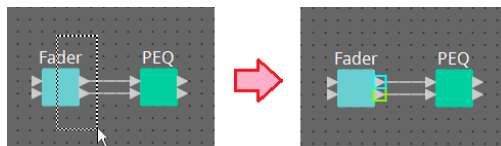

- **Hold down < Ctrl > and use the mouse cursor to completely or partially enclose objects**

Hold down < Ctrl > and drag the mouse cursor to select the components, component ports, wires, and text that are completely or partially enclosed by the rectangular area in the design sheet.



If the selection encloses an expanded User Defined Block, and the point at which you start dragging is on the style sheet, then the objects on the style sheet and the User Defined Block are selected. If the point at which you start dragging is on a User Defined Block, then objects on the User Defined Block are selected.

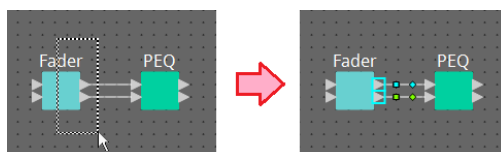

- **Hold down < Ctrl > and click objects**

Hold down < Ctrl > and click the target that you want to select.

If you hold down < Ctrl > and click an object that is already selected, the selection is cleared. This is convenient when you have selected multiple objects by enclosing them, and then want to de-select one of the selected objects.



If objects in a User Defined Block and on the style sheet are simultaneously selected, there are some limitations on operation; for example, you can't move components.

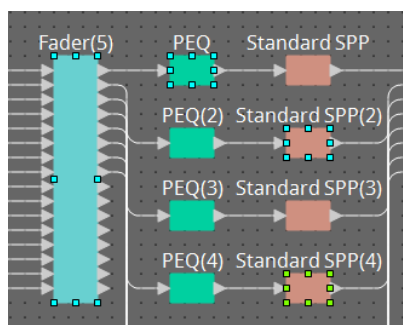

### 13.7.3. Connecting ports

Here we explain how to make connections between ports of components by creating a wire between the ports.

- **Making one connection at a time**

Drag one output port to the input port of the destination component.

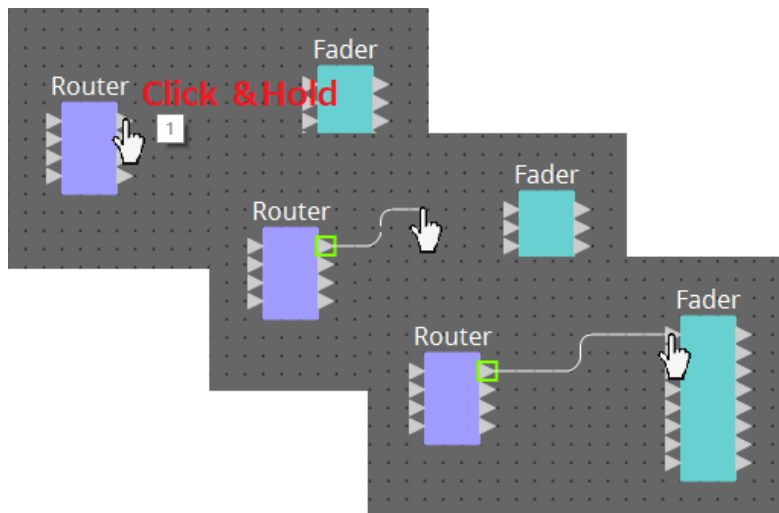

- **Making multiple connections at a time**

Select multiple output ports, and drag one of these ports to an input port of the destination component.

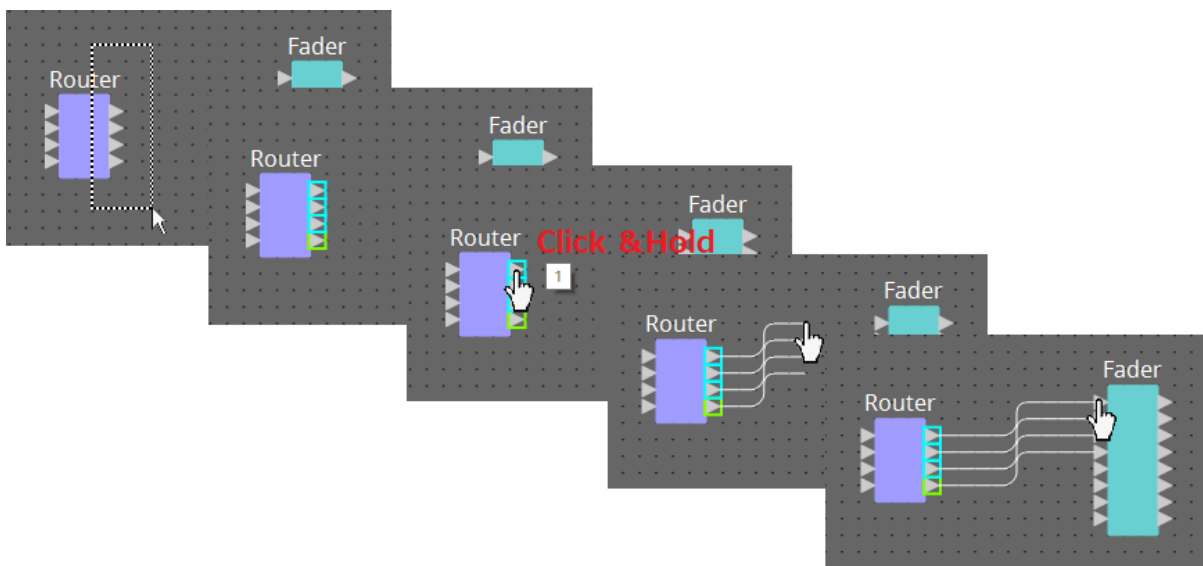

### 13.7.4. Tracing the signal path

Here we explain how to view the signal path.

To view the signal path, click the  Trace Signal Path button on the toolbar or add a check mark to the [Tools] menu → [Trace Signal Path] command.

- **Click a wire**  
The path of the signal flowing through that wire is shown.
- **Click a port**  
The path of the signal flowing through that port is shown.

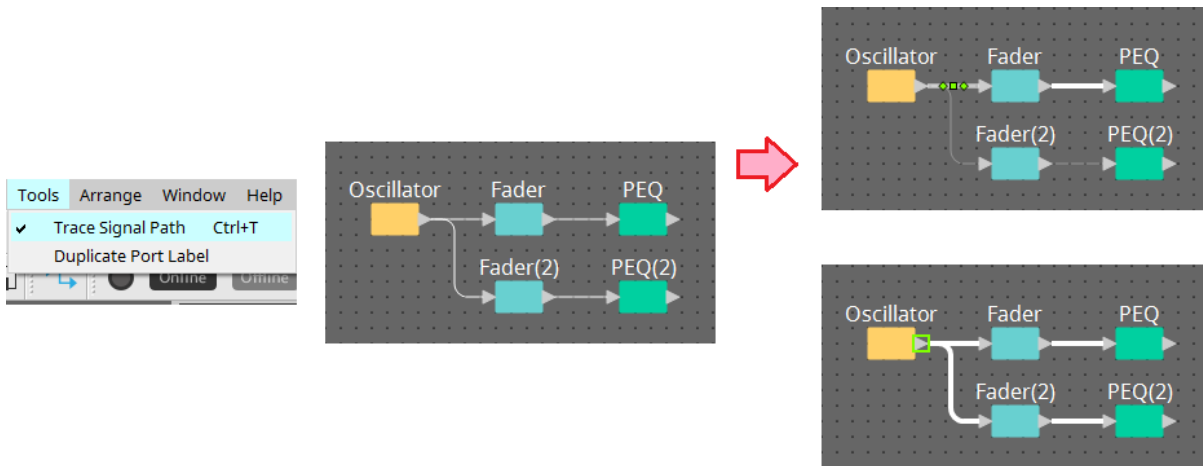

If the signal path is connected but no audio signal flows because it is turned OFF or the level is minimized, the signal path is shown as a dashed line.

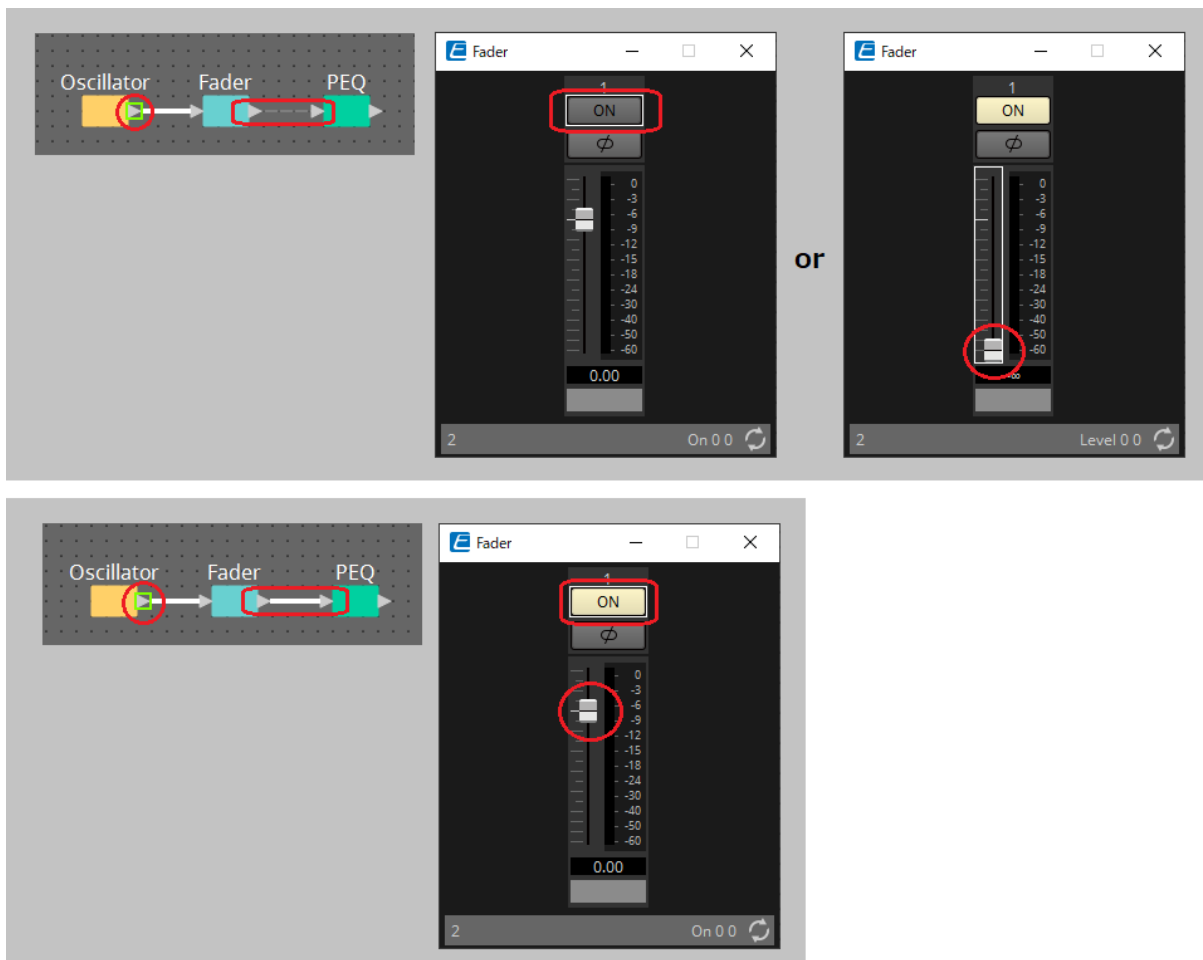

### 13.7.5. Duplicating an input port name

If you want to use the signal name as the port name, it is convenient to duplicate the port name.

Here we explain how to automatically duplicate the input port name.

In general, the input port name is automatically duplicated to the input port of the connection destination component, but the following exceptions apply.

- For a mixer-type component or a component that has only an output, the output port name is duplicated to the input port of the connection-destination.
- If the duplication-source port name is blank, it is not automatically duplicated.



If the port name has already been specified, the port name is overwritten by the automatic duplication.

#### • Automatically duplicating the port name when components are connected

If [Tools] menu → [Duplicate Port Label] has a check mark, the port name is automatically duplicated when you make a connection between components.

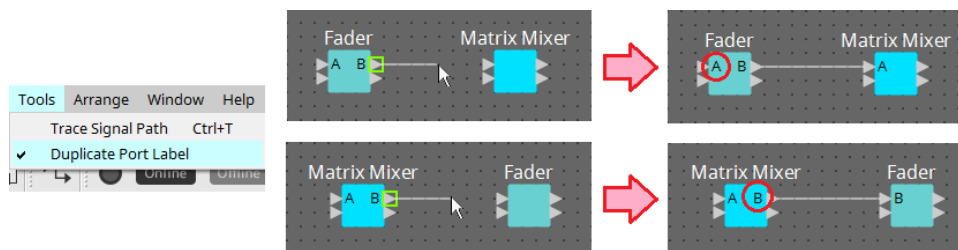

#### • Duplicating the port name of components along the signal path

In the context menu that appears when you right-click a port or component, choose [Duplicate Port Label - to the right] or [Duplicate Port Label - to the left]; the input port name is duplicated to the input port of the following or preceding components.

However if a mixer-type component exists within this path, duplication stops at the mixer-type component.

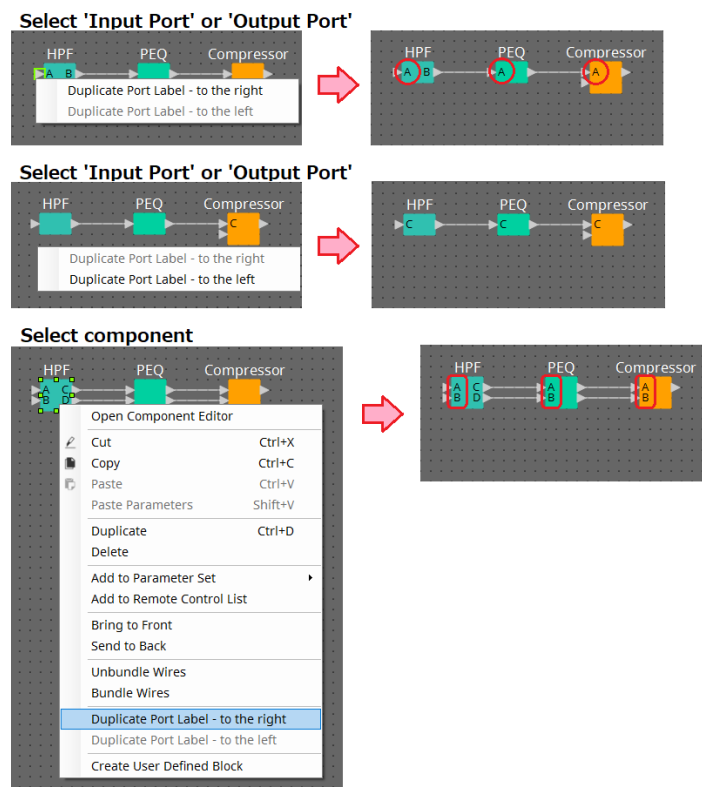

### 13.7.6. About [Unbundle Wires]

After you have placed all of the necessary components and have finished creating wires between them, you can select all components and execute [Unbundle Wires] to prevent the wires from overlapping in the display. When you execute [Unbundle Wires], the items in the “Properties” area for the components and the wires connected to the components are set to the following values.

	Item	Value
Component	Output Wiring Step	An appropriate value will automatically be displayed.
	Input Wiring Step	An appropriate value will automatically be displayed.
Wire	Wire Routing	Automatic
	Auto Block Avoidance	False

If you want to selectively change the spacing between the wires, perform the operation above, and then change the [Output Wiring Step] or [Input Wiring Step] values.

If you don't want wires to overlap when you're making connections, execute the following procedure.

1. Place all components.
2. Select all components, and execute [Unbundle Wires].
3. Make one connection between components, and select the wire.
4. Set the wire's [Wire Routing] to [Automatic], and set [Auto Block Avoidance] to [False].
5. Click the [Save Style] button to save the wire's user style to the computer.

Subsequently when you connect wires, they are shown without overlapping.

**Select All Components**

Edit Menu  
Unbundle Wires

Edit Menu  
Bundle Wires

**Change Wire Style**

Properties

Wire

Label

Style

Wire Routing **Automatic**

Auto Block Avoidance **False**

Orthogonal Wire **True**

Orthogonal Wire **RoundedLineWithJu**

Save Style

**Make Connections**

Properties

Component

Component Type Fader

Form **8Ch**

Label **Fader(3)**

ID 30009

Display

Output Wiring Step **10**

Input Wiring Step **10**

Properties

Component

Component Type Fader

Form **8Ch**

Label **Fader(3)**

ID 30009

Display

Output Wiring Step **2**

Input Wiring Step **2**

### 13.7.7. Duplicating components

Here we explain how to duplicate components together with their parameters.

- **Right-click a component and choose [Duplicate]**

A duplicate, overlapping component is created. If multiple components with their wires are selected when you choose [Duplicate], the components are duplicated together with their wires.

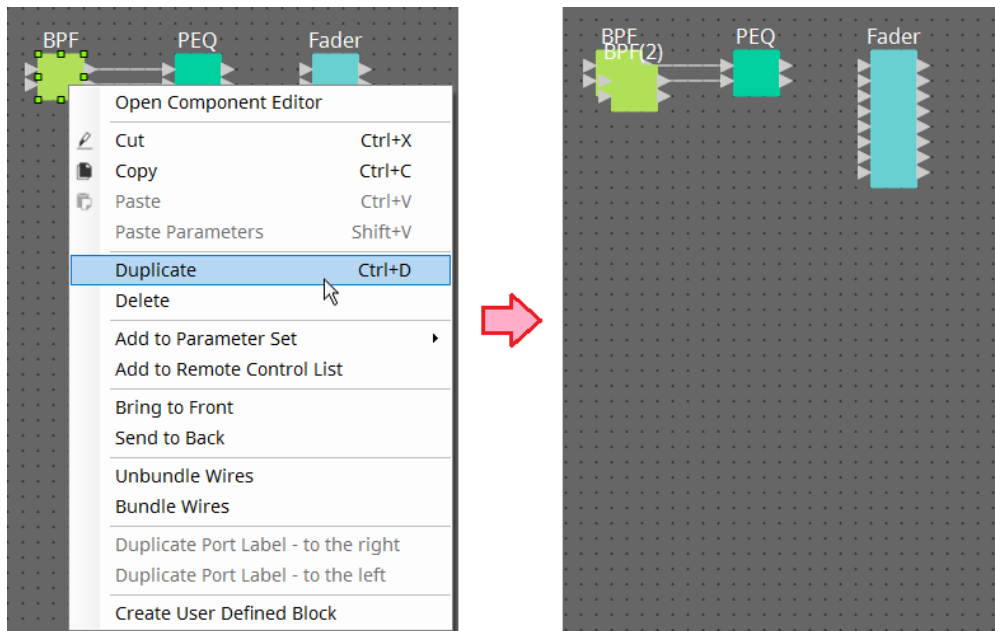

- **Drag and drop a component while holding down < Ctrl >**

A duplicate is created where you drop the component.

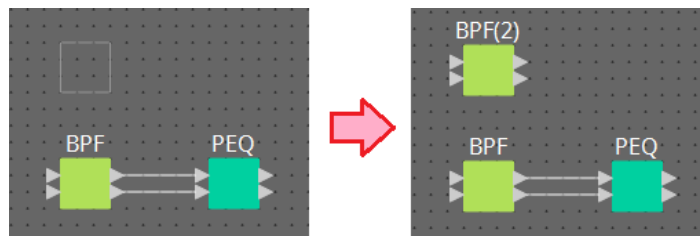

- **Drag and drop multiple components with their wires while holding down < Ctrl >**

Duplicates of the components together with their wires are created where you drop the component.

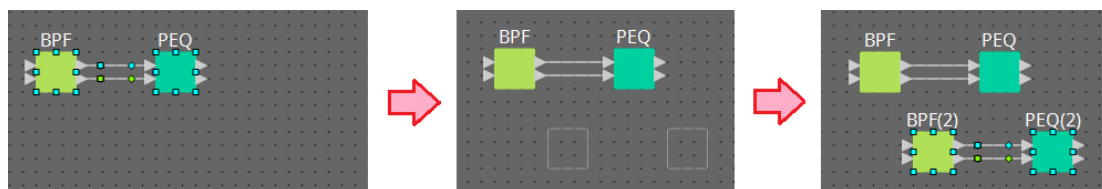

## 13.8. Design sheet: Audio layer

This layer enables you to place audio components to create a configuration. You can control audio signals by wiring between audio components.

### 13.8.1. Audio Component

For more information on how to use the component editor, refer to Chapter 12. For details on components, refer to the ["ProVisionaire Design DME7 Component Guide"](#).

## 13.9. Design sheet: Control layer

This layer handles control signals. You can manipulate control signals by wiring between the control components or audio components.

Control components can be manipulated via changes in parameters or meters for the audio components. Audio components can be manipulated via changes in parameters for the control components. You can also place snapshots in the Control layer, which can be treated as part of the configuration.

### Control Component

For more information on how to use the component editor, refer to Chapter 12. For details on components, refer to the ["ProVisionaire Design DME7 Component Guide"](#).

#### 13.9.1. Using the audio component parameters in the Control layer

1. Select the Audio layer.

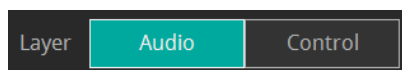

2. Select the "Parameters" area, and then select the audio component in the sheet.

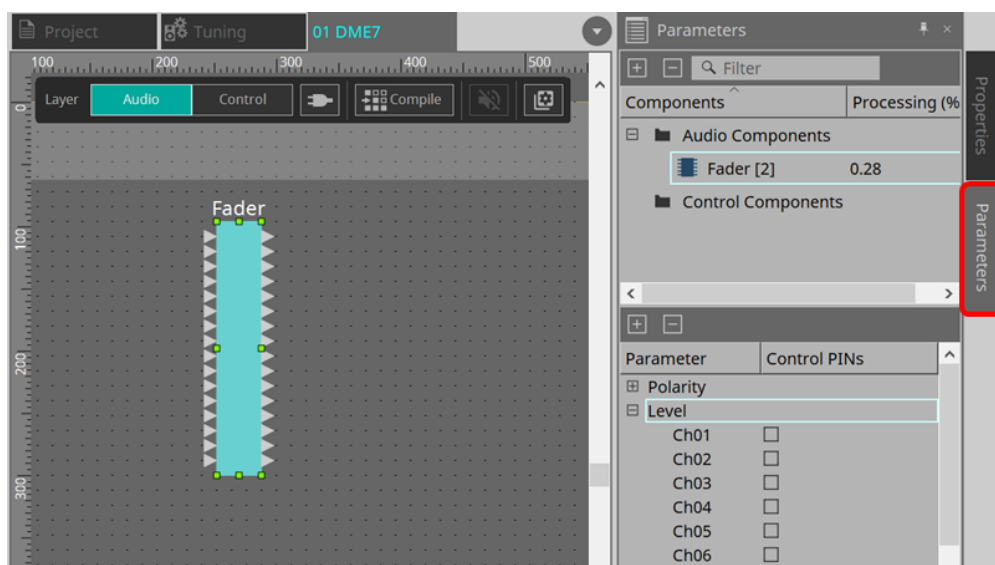

In the Control PINs column, add a check mark to the check box for the desired parameters. The audio component is placed in the Control layer, too.

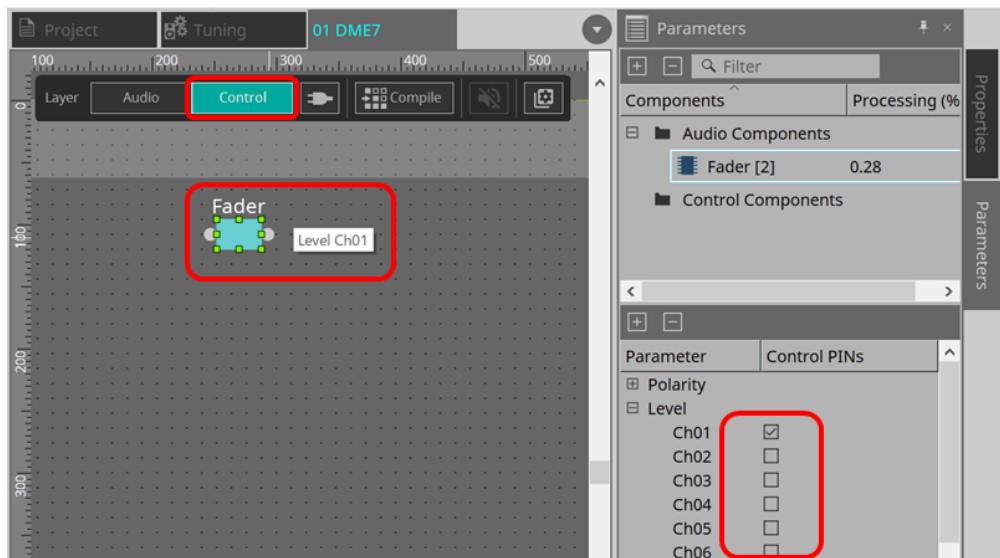

If you turn off the “Layer Link” command (one of the Tools buttons), the position of the audio component placement will be asynchronized (unlinked) between the Audio layer and Control layer.

### 3. Place the control component in the Control layer and do the necessary wiring.

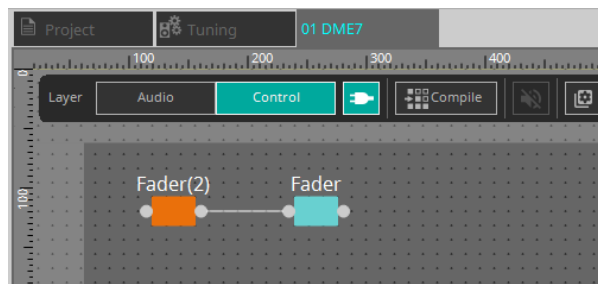

### 4. Turn on the [Control Function] button and manipulate the control component parameters to simulate the operation.

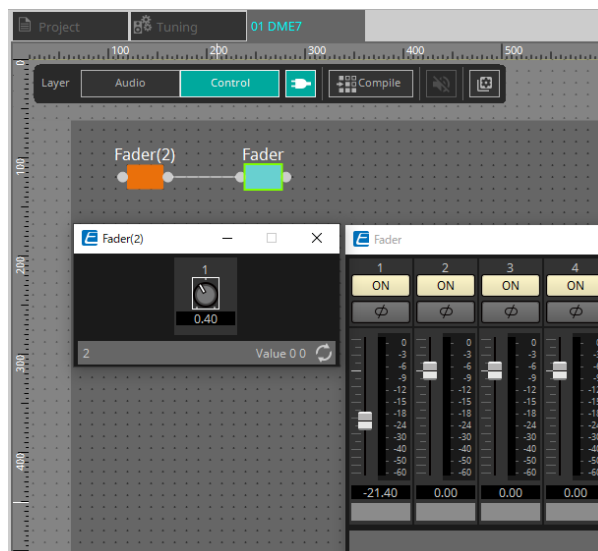

You cannot edit the configuration while the [Control Function] button is turned on.



## 13.9.2. Controlling a Snapshot and ParamSet in the control component

You can control a snapshot and parameter set in the control component.

For more information on the parameter set and snapshot, refer to the “Parameter Sets’ area” section.

### ■ An example of control using the Snapshot component

1. Drag and drop a snapshot from “Snapshot” in the “Parameter Set” area to the Control layer. The Snapshot component appears in the Control layer.

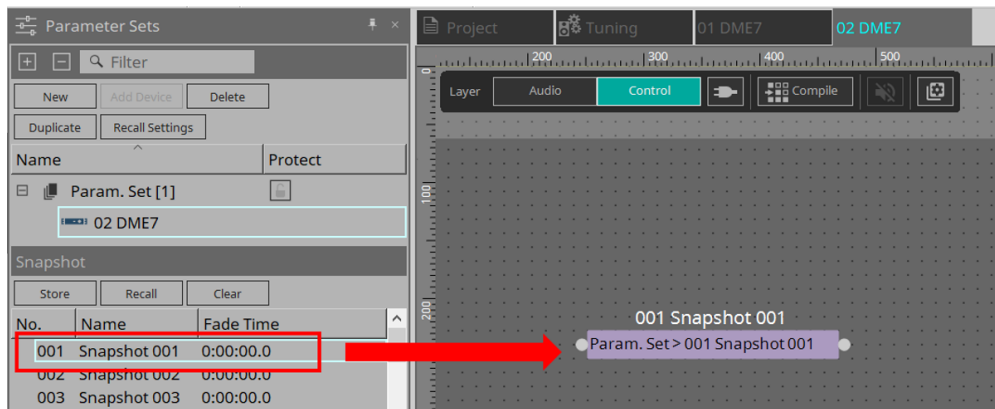

2. Snapshot is recalled when a signal is input to the input port.
3. When the snapshot is recalled, “1” is output from the output port.

### ■ An example of control using the ParamSet component

You can also control a snapshot using the ParamSet component. In this section, two control examples are introduced: using Snapshot pins, and using a Sel pin.

#### [1] An example of control using Snapshot pins

1. Drag and drop the Parameter Set in the “Parameter Sets” area to the Control layer. The Param.Set component that includes multiple Snapshot components appears in the Control layer.

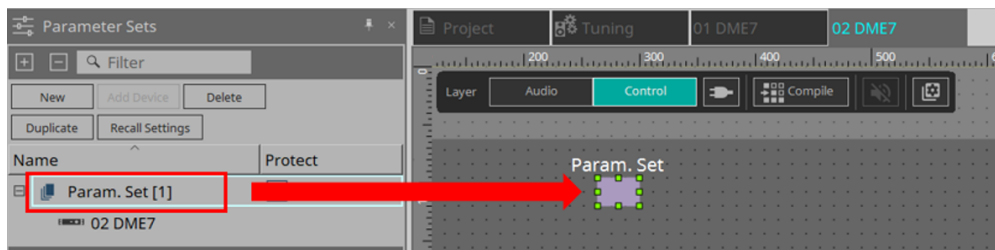

2. Select Parameter Set in the “Parameters” area, and then click the “+” mark next to “Snapshot” to expand the snapshot list.

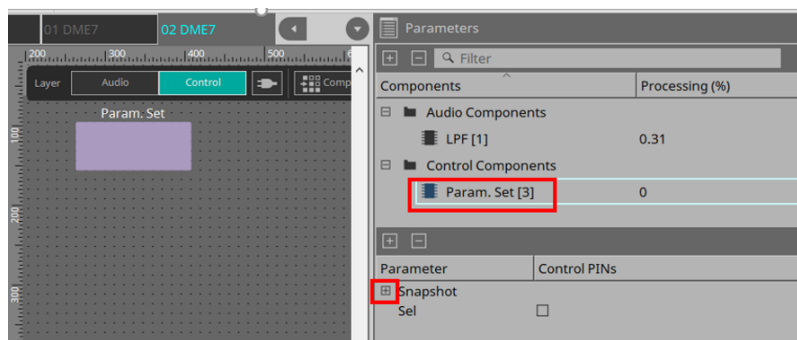

3. Add a check mark to the check box for a desired Snapshot number in the Control PINs column. Input/output ports are added to the components on the sheet. The recall method is the same as the "■ An example of control using the Snapshot component".

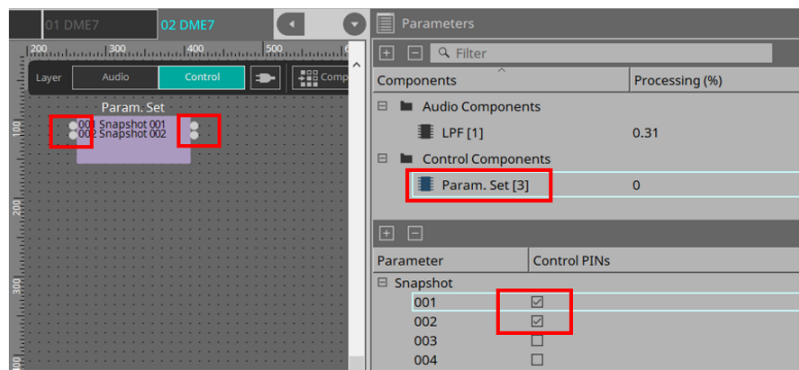

## [2] An example of control using a Sel pin

1. Select Parameter.Set in the "Parameters" area, and then add a check mark to "Sel" in the Control PINs check box, it will be added to the input port of the component on the sheet.

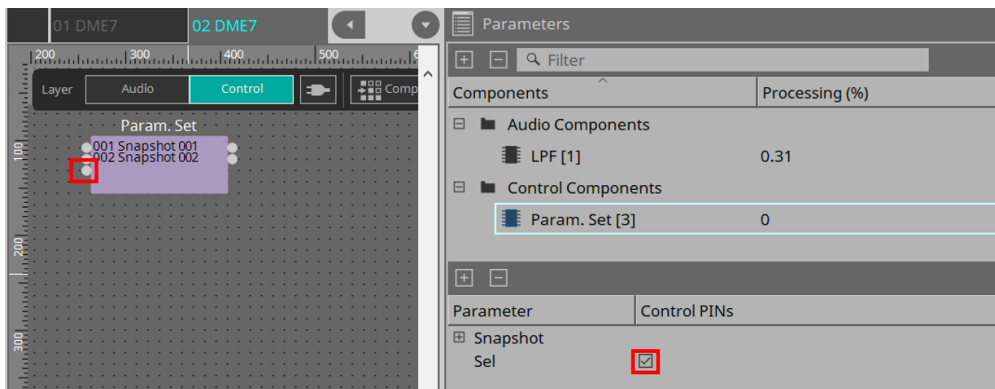

2. Enter a desired number (1 to 100) into the Sel input pin. The Snapshot component corresponding to that number is recalled. (At this time, the output pin for this component outputs "1.")

## 13.10. Components other than audio or control components

### 13.10.1. Transmitter/Receiver

This function wirelessly connects components that are located at a distance from each other on the design sheet.

The Transmitter component and Receiver component of the same component label are connected.

If there are multiple ports, identically-numbered ports are connected to each other. One Transmitter component can be connected to multiple Receiver components.

When placing this component in the design sheet, select the component label and the number of channels. Either enter a new name as the component label, or select a component label with which it will be associated. As the number of channels, select the number of channels that you want to use.

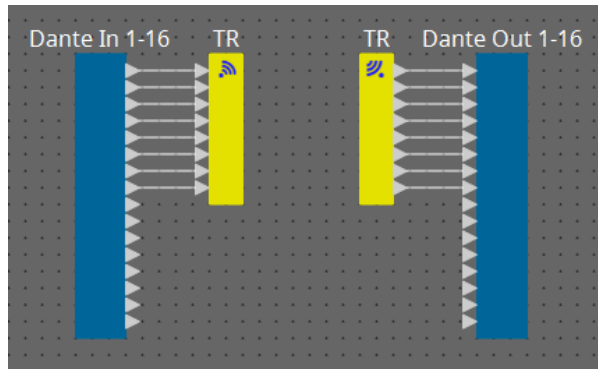

When you select a wire and press < Space >, a Transmitter component and Receiver component are added.

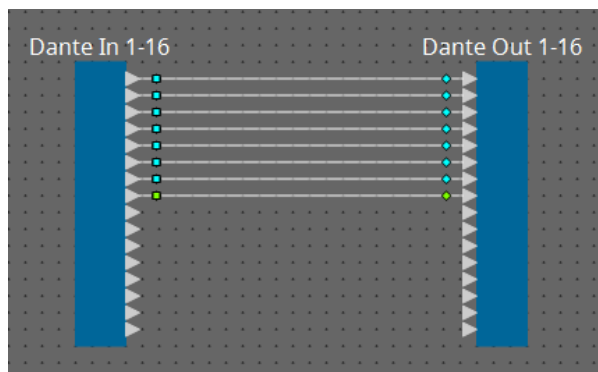

↓ <Space>

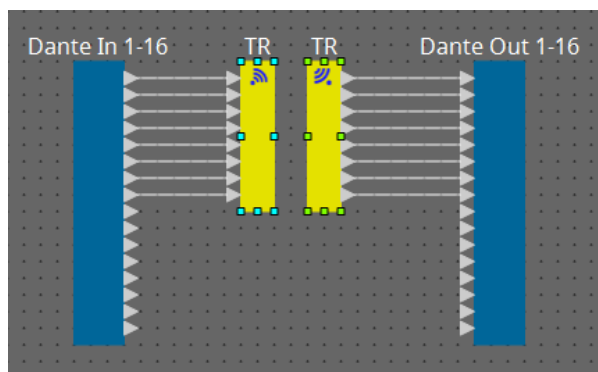

If you hold down the mouse button in the middle of a connection and press < Space >, a Transmitter component or Receiver component is created.

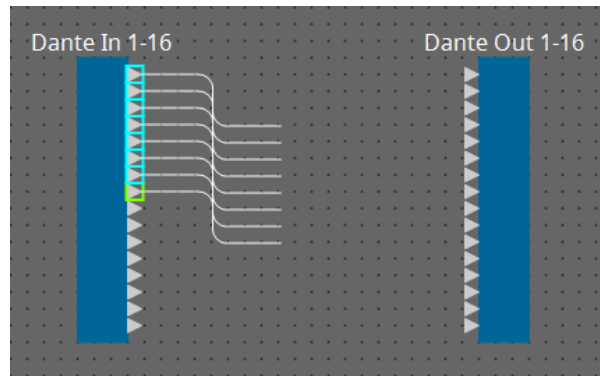

↓ <Space>

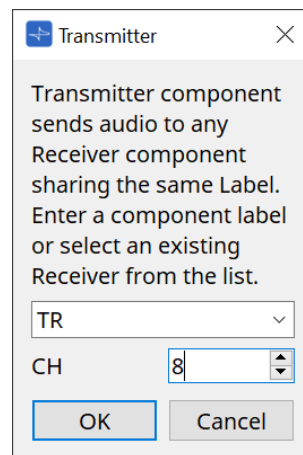

↓ [OK]

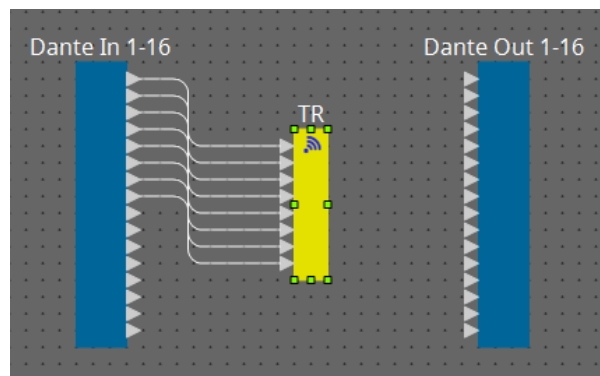

### 13.10.2. User Defined Block

Components and the wires between components can be encapsulated as a User Defined Block. By encapsulating multiple components as a single block, you can make the style sheet look cleaner, or copy blocks to easily create the same functionality for other channels.

A protect function is provided for User Defined Block. By protecting it, you can prevent another person from changing the configuration or parameters, or prevent them from looking inside.

Here's how to place a User Defined Block.

- Drag and drop from the "Component" area. (An empty block is placed.)
- With the components selected, right-click and choose [Create User Defined Block]. (This places a block that contains the selected components.)
- With the components selected, choose [Edit] menu → [Create User Defined Block]. (This places a block that contains the selected components.)

When placing a User Defined Block, specify the number of inputs and outputs as a block. The number of inputs and outputs can be changed later in "Form" of the "Properties" area. The inputs and outputs directly connect components outside the block with components inside the block.

To show or hide the contents of a block, click the [+]/[-] in the upper left of the block, or doubleclick the block.

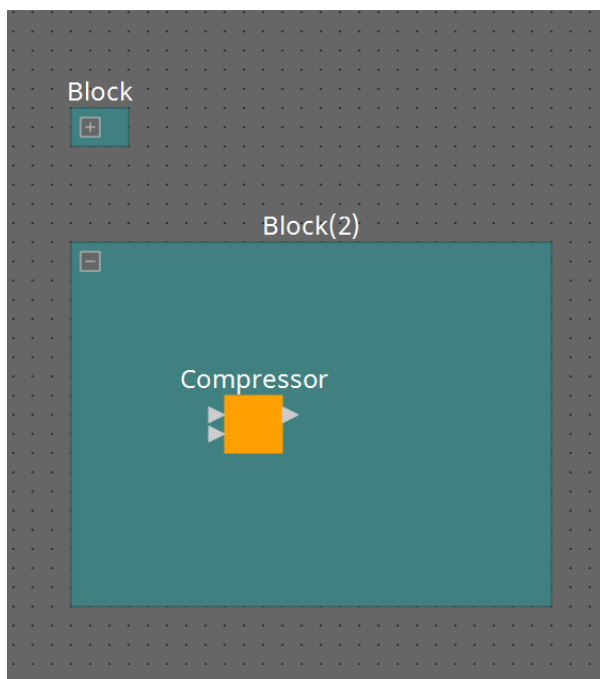

Components in a block can be placed, connected, and edited in the same way as in a design sheet.

With a block selected, you can drag and drop the top, bottom, left, or right corners to expand or shrink the block. With an expanded block selected, you can drag and drop the top, bottom, left, or right edges to move the block on the design sheet.

Here's how to unpack a User Defined Block.

- Right-click the block and choose [Unpack User Defined Block].
- With the block selected, choose [Edit] menu → [Unpack User Defined Block].

There are three User Defined Block protection modes.

- **Off mode**

The unprotected state.

- **View Only mode**

A protected User Defined Block or a component editor inside the block can be opened, but the configuration and parameters cannot be changed. Components in the User Defined Block are not shown in the “Parameters” area.

A lock icon (🔒) is shown at the lower left of the component editor in a protected block.

- **Protect mode**

A protected User Defined Block cannot be opened. Components in the User Defined Block are not shown in the “Parameters” area. Use this when you want to keep the content completely concealed.

A lock icon (🔒) is shown at the upper left of the protected block.

To apply protection, proceed as follows.

1. **Select the User Defined Block that you want to protect.**  
If you select multiple User Defined Blocks, they will be protected in the same mode.
2. **In the “Properties” area, use [Lock Mode] to specify the lock mode that you want to apply.**

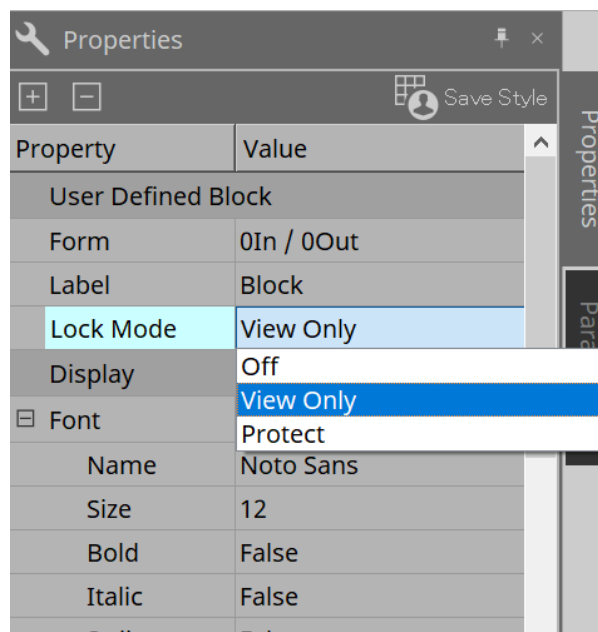

3. **As necessary, repeat steps 1 and 2 to specify the lock mode for other User Defined Blocks.**
4. **Choose [Edit] menu → [Protect User Defined Block] from the [Tools] button in the “Device” sheet.**  
The “Protect User Defined Block” dialog box appears.

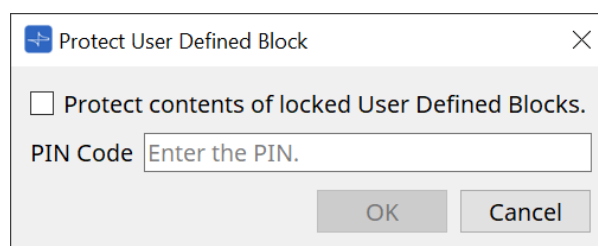

Enter the PIN code and click the OK button to set the same PIN to all User Defined Blocks whose Lock Mode is “Protect”.

To remove protection, proceed as follows.

1. Choose **[Edit] menu** → **[Protect User Defined Block]** from the **[Tools]** button in the “Device” sheet.  
The “Unprotect User Defined Block” dialog box appears.

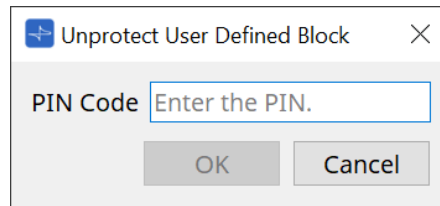

2. Enter the PIN Code that was specified when locking, and click the **[OK]** button.  
The “Protect User Defined Block” dialog box appears.

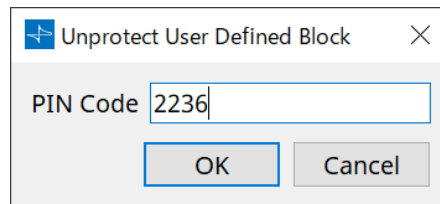

3. Clear the check mark from the “Protect contents of locked User Defined Blocks” check box.

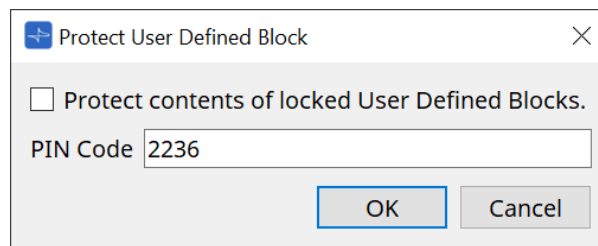

4. Click the **[OK]** button.  
Protection is removed. The [Lock Mode] setting is maintained.

---

### 13.10.3. Text

This is a text box used to place text in the design sheet.  
You can double-click the area displayed as [Text], and enter text.

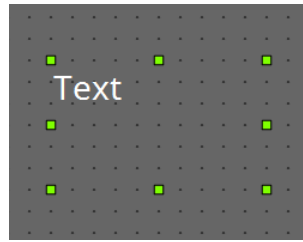



## 13.11. “Parameter Sets” area

A set of parameters stored or recalled as a snapshot is called a “parameter set.” Storing a snapshot saves the current values of the parameter set members. One parameter set can store up to 100 different snapshots. A parameter can be registered in more than one parameter set.

Parameters can be registered in a parameter set in the following ways.

Registration source	Registration method
Design sheet	While holding down < Ctrl >, drag and drop a component onto a parameter set name.
	Right-click a component, and use [Add to Parameter Set] to select the parameter set to which it will be registered.
Component editor	While holding down < Ctrl >, drag and drop a parameter onto a parameter set name.
“Parameters” area*1	Drag and drop the component or parameter onto a parameter set name.
	Right-click the component or parameter, and use [Add to Parameter Set] to select the parameter set to which it will be registered.
“Parameter Sets” area	After selecting the parameter set to register, click the [Add Device] button to register all components placed at that point.

\*1. You can also use < Shift > or < Ctrl > to simultaneously register multiple components or parameters in a parameter set.

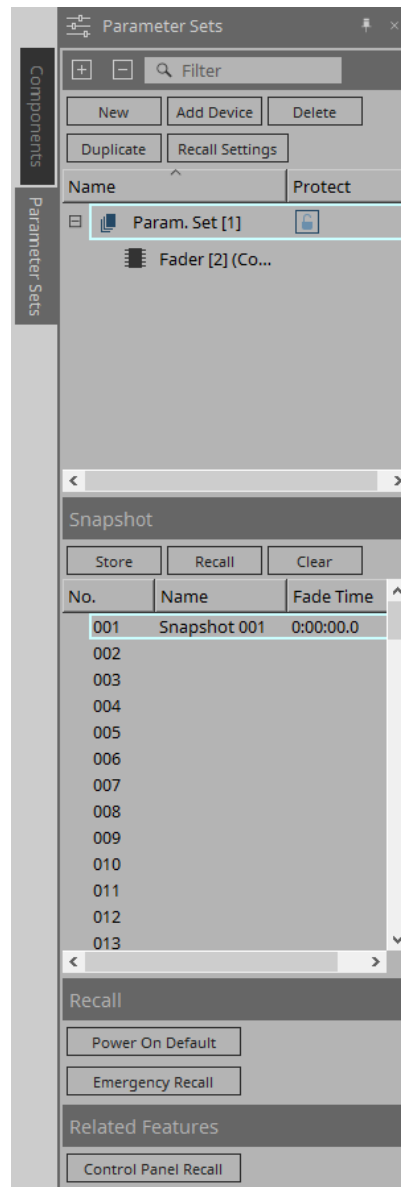

### 13.11.1. Parameter Sets

- **[New] button**  
Creates a new parameter set.
- **[Add Device] button**  
Registers an individual device to the parameter set.
- **[Delete] button**  
Deletes the selected parameter set, DME7, component, or parameter.



If you changed the members that were registered to a parameter set, you must overwrite and save the snapshots again.

- **[Duplicate] button**  
Duplicates the selected parameter set. If you want to duplicate the snapshots as well, add a check mark to [Duplicate Snapshots Also] in the “Duplicate” dialog box that appears.
- **[Recall Settings] button**  
To start or stop file playback via the GPI Out or SD card along with the snapshots, use the “Recall Settings” dialog box to set up.

- **Parameter set name**

Shows the name of the parameter set. You can double-click the parameter set name and edit it.



A number displayed next to the parameter set name is the parameter set ID. You can specify this ID when you recall a snapshot via the remote protocol command. To modify the ID, right-click the parameter set name to display the context menu, and then select [Change ID].



If any parameter set in the “Parameter Sets” area is selected, pressing an alphabetical key will select the parameter set of the matching initial letter.

- **Protect**

If Protect is turned on, you will be unable to change the parameter set or store snapshots.

Click here repeatedly to turn Protect on (🔒) or off (🔓).

Right-click the parameter set name to open the [context menu](#).

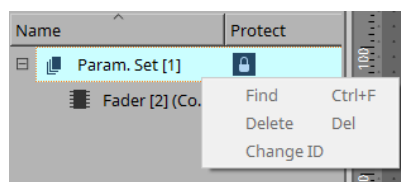

### 13.11.2. Snapshot

- **[Store] button**

Stores (saves) a snapshot.

- **[Recall] button**

Recalls a snapshot.

- **[Clear] button**

Deletes a snapshot.

- **[Fade Time] field**

This shows the time (Fade Time) that is taken to change the level of fader components or the send level of Matrix components that are registered in the parameter set. Doubleclick this to open the “Fade Time” dialog box. In the dialog box that appears, specify the time over which the change will happen. You can specify up to three hours.

### 13.11.3. Recall

- **Power On Default**

You can specify whether a snapshot will be recalled when you turn on the power to the unit. Press the [Set] button in the “Power On Default” dialog box if you want the currently-selected snapshot to be recalled.

If the snapshot is not assigned to be recalled, the unit will start up using the latest setting obtained immediately before the power was turned off. To cancel the assignment, select [Clear] in the “Power on Default” dialog.

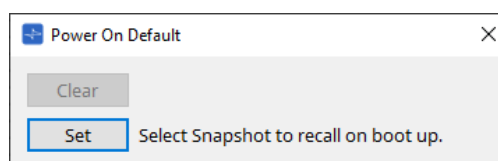

### • Emergency Recall

You can specify whether a snapshot will be recalled if the DME7 receives an EMG (Emergency) signal from an external device, or if the input voltage to the [GPI IN] connector (IN 16) (which supports +24V) falls below 2.5V.

Refer to the “Power On Default” dialog box section for information on how to set or clear the assignment.

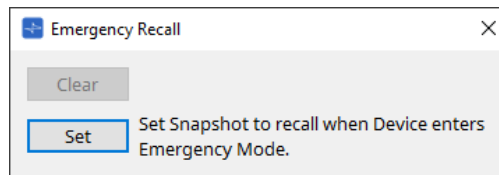

## 13.11.4. Related Features

### • Control Panel Recall

Register the snapshot that will be recalled on the device control panel.

Click the > button to register it.

Click the < button to delete a snapshot from the registration list.

Click the << button to delete all snapshots from the registration list.

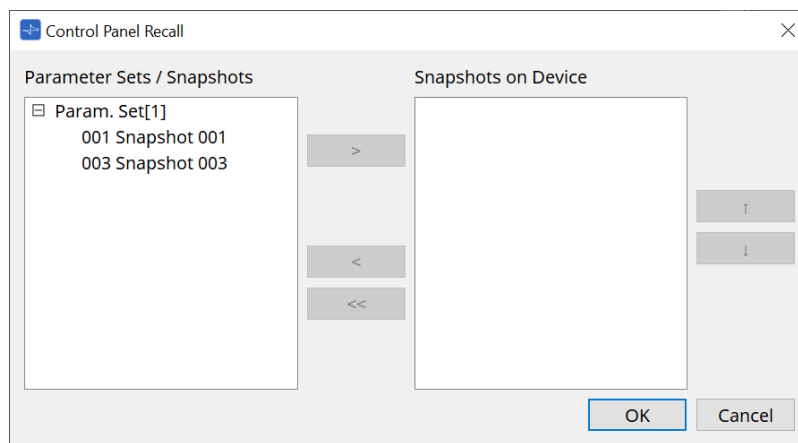

Use the up and down arrow buttons to change the order of the snapshots displayed on the device panel.

### 13.11.5. "Recall Settings" dialog box

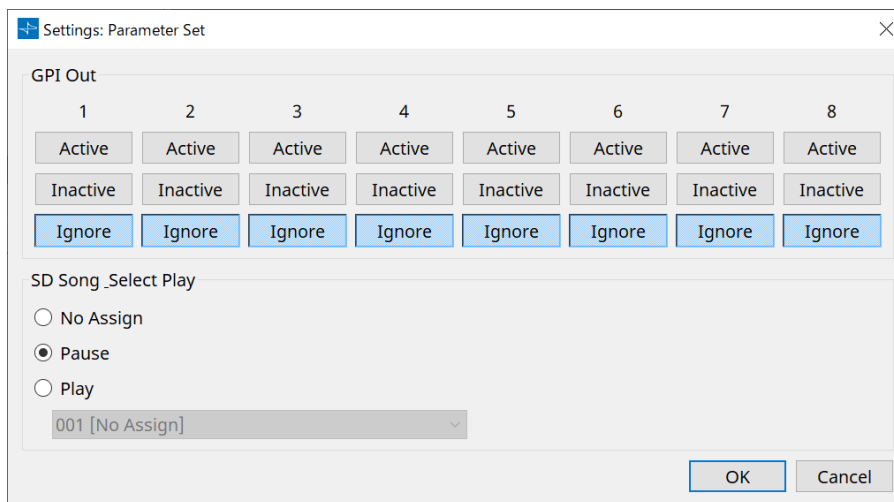

#### • GPI Out

Here you can specify the GPI OUT settings that will be output when the snapshot is recalled.

You can use GPI OUT output to control a device that's connected to this unit's [GPI OUT] connector.

#### **[Active]/[Inactive]/[Ignore] buttons**

Specify whether the GPI OUT connector's output will be enabled (Active), enabled with the OUTPUT TYPE inverted (Inactive), or ignored (Ignore).

If the [OUTPUT TYPE] in the GPI Output dialog box setting is set to [Pulse] or [Pulse Inv.], the only available choices will be [Active] and [Ignore].

##### ◦ If [Active] is specified

When [OUTPUT TYPE] is [Closed], the [GPI OUT] pin will be closed (connected to ground).

When [OUTPUT TYPE] is [Open], the [GPI OUT] pin will be open.

When [OUTPUT TYPE] is [Pulse], the [GPI OUT] pin will be closed (connected to ground) for approximately 250 ms.

When [OUTPUT TYPE] is [Pulse Inv.], the [GPI OUT] pin will be open for approximately 250 ms.

##### ◦ If [Inactive] is specified

When [OUTPUT TYPE] is [Closed], the [GPI OUT] pin will be open.

When [OUTPUT TYPE] is [Open], the [GPI OUT] pin will be closed (connected to ground).

##### ◦ If [Ignore] is specified

There will be no change in the output. Use this setting if a different function is assigned to GPI OUT and you don't want that function to be affected by snapshot recall.

#### • SD Song Play

##### ◦ **Pause**

Stops playing the file immediately when a snapshot is recalled.

##### ◦ **Play**

Plays the specified file immediately when a snapshot is recalled.

You can play files that are stored on the SD card specified in the "SD Card File Manager" dialog box.

## 13.12. "Properties" area

In this area you can edit setting for the currently-selected component or wire.

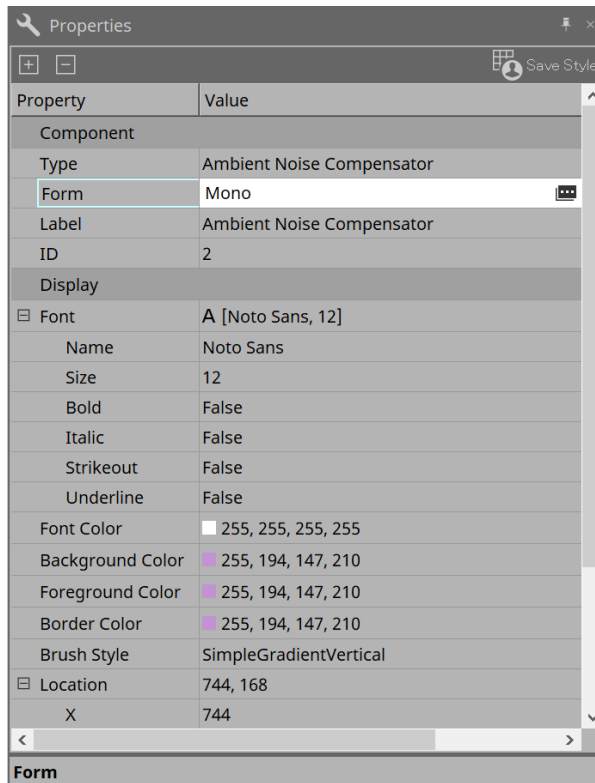

- **Component**

Click the Value field in the "Component"/"Form" to make the  appear, a dialog for changing the number of channels of the component, etc. will be displayed.

This cannot be changed on a component for which  is not shown.

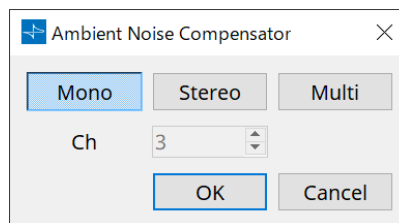

- **Port**

If you click on the  that appears when you click on the "Label" Value, the [Port Label dialog](#) box will be displayed, allowing the labels of all ports of the component to be edited at once.

## 13.13. "Parameters" area

This area displays information about the component that is currently selected in the Design sheet (Audio layer or Control).

The upper part of this area indicates the signal processing capacity of each component as a percentage.

The lower part of this area lists the parameters for the component currently selected in the upper part.

If you add a check mark to the check box in the Control PINs column, you will be able to control the corresponding parameter in the Control layer.

From this area, you can assign components and parameters to a parameter set, Remote Control Setup List, GPI dialog box, MIDI dialog box, and DCP component. For more information on how to assign them, refer to the section for the corresponding dialog box or screen.

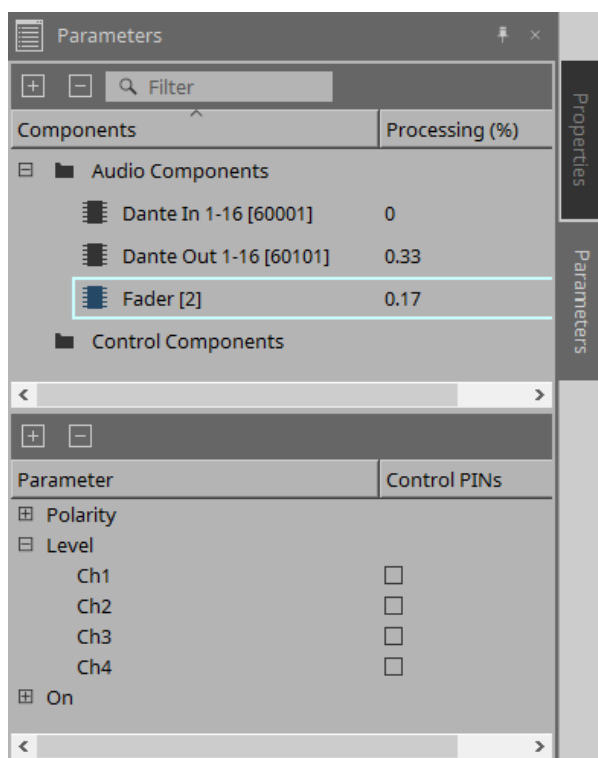

- **Components**

Lists the components currently selected in the sheet.

- **Processing**

Indicates the resources to be processed as a percentage.

- **Parameters**

Lists the parameters for the component currently selected in the upper part.

- **Control PINs**

If you add a check mark to the check box in this column, you will be able to control the corresponding parameter in the Control layer.

Immediately after you add a check mark, the corresponding audio component will be placed in the Control layer.

## 13.14. Context Menu

### 13.14.1. Design sheet

The following context menu appears when you right-click a design sheet that contains no objects.

Menu	Content
[Paste]	Pastes the copied component in the "Design" sheet.
[Select All]	Selects all components and wires in the design sheet.
[Close All Editor Windows]	Closes all component editor and parameter setting windows.
[Snap to Grid]	If this is checked, objects are aligned with the grid of the design sheet.
[Layer Link]	Enable this command to synchronize (link) the position of the audio component placement between the Audio layer and Control layer.

### 13.14.2. Components

When you right-click a component, the following context menu appears (not all items are shown for all components).

Menu	Content
[Open Component Editor]	Opens the component editor.
[Cut]	Moves the selected item to the copy buffer.
[Copy]	Copies the component, including the parameter settings of the component editor.
[Paste]	Paste the copied component onto the design sheet.
[Paste Parameters]	Duplicates the copied component, including the parameter settings of the component editor.
[Duplicate]	Duplicates the copied component, including the parameter settings of the component editor.
[Delete]	Deletes the component.
[Add to Parameter Set]	Registers the component to the parameter set.
[Add to Remote Control List]	Registers all of the component's parameters or the component's meters in the Remote Control Setup List. If multiple components are registered simultaneously, they are registered as meters.
[Bring to Front]	Moves the component display to the foreground.
[Send to Back]	Moves the component display to the background.
[Unbundle Wires]	Displays the wires connected to the selected component or User Defined Block spaced apart at equal intervals.
[Bundle Wires]	Displays the wires connected to the selected component or User Defined Block overlaid together.
[Duplicate Port Label - to the right]	Duplicates the input port name of the selected component to the input ports of the downstream components along the signal path.



Menu	Content
[Duplicate Port Label - to the left]	Duplicates the input port name of the selected component to the input ports of the upstream components along the signal path.
[Create User Defined Block]	Encapsulates the selected components as a User Defined Block.

### 13.14.3. Component Ports

Menu	Content
[Duplicate Port Label - to the right]	Duplicates the port name of the input port corresponding to the selected input or output port to the input ports of the downstream components along the signal path.
[Duplicate Port Label - to the left]	Duplicates the port name of the input port corresponding to the selected input or output port to the input ports of the upstream components along the signal path.

### 13.14.4. Component editor / Parameter setting window

When you right-click a component editor or a parameter setting window, the following context menu appears.

Menu	Content
[Register as default values]	Register the component's current parameter values in a style as the default values. New components will be placed with the registered default values. The registered default values can be imported/exported as a style file.
[Reset default values to Factory Default]	Returns the default value of the component to the values immediately after ProVisionaire Design was installed.
[Copy]	Copies the component, including the parameter settings of the component editor.
[Paste Parameters]	Content If you select an existing component of the same type and execute this, the copied parameters of the component are applied.
[Add to Parameter Set]	If you execute this on a parameter, the parameter is registered in the parameter set. If you execute this elsewhere than on a parameter, the component is registered in the parameter set.
[Add to Remote Control List]	If you execute this on a parameter, the parameter is registered in the Remote Control Setup List. If you execute this elsewhere than on a parameter, all of the component's parameters or the component's meters are registered in the Remote Control Setup List.

### 13.14.5. Wire

Right-click an item to open the subsequent context menu.

Menu	Content
[Delete]	Deletes the wire.

Menu	Content
[Bring to Front]	Moves the selected wire to the front.
[Send to Back]	Moves the selected wire to the back.
[Add to Transmitter & Receiver Space]	Connect wires to the Transmitter and Receiver components.
[Insert Node]	Add nodes to the wire. * A node is a dividing point of a wire.
[Remove Segment]	Removes wires between nodes.

### 13.14.6. "Parameter Sets" area

Right-click an item to open the subsequent context menu.

Menu	Content
[Find]	Searches the "Device" sheet for a component or its parameter.
[Delete]	Deletes the parameter set. Settings in a lower level are also deleted.
[Change ID]	Enables you to change the parameter set ID. The number displayed next to the parameter set name is the parameter set ID. You need to use this ID when you recall a snapshot via the SCP protocol command.

### 13.14.7. "Parameters" area

The following context menu appears when you right-click a parameter.

Menu	Content
[Find]	If you execute this for a component, the corresponding component in the design sheet is selected. If you execute this for a parameter, the component editor that includes the corresponding parameter will open with that parameter selected.
[Add to Parameter Set]	If you execute this on a parameter, the parameter is registered in the parameter set. If you execute this on a component, the component is registered in the parameter set.
[Add to Remove Control List]	If you execute this on a parameter, the parameter is registered in the Remote Control Setup List. If you execute this elsewhere than on a parameter, all of the component's parameters or the component's meters are registered in the Remote Control Setup List. If you try to register a component, a dialog box will appear to enable you to select the registration method.

If you try to add a component to the Remote Control Setup List, the following dialog box will appear.

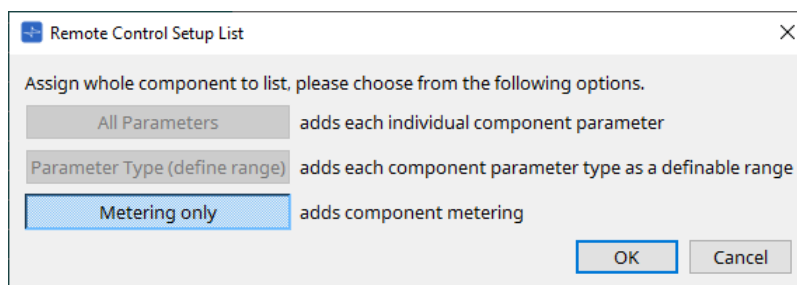

- **[All Parameters] button**  
Enables you to register all of the component's parameters.
- **[Parameter Type (define range)] button**  
Enables you to register the component's parameters by type.
- **[Metering only] button**  
Enables you to register the component's meters by type.

## 13.15. Dialog box

### 13.15.1. "Compile" dialog box

To open this dialog box, click the [Compile] tool button in the "Device" sheet.

Analyzes the placement and wiring of the components in the DME7 system to determine whether there are any problems. Here you can also view statistics such as the resource usage.

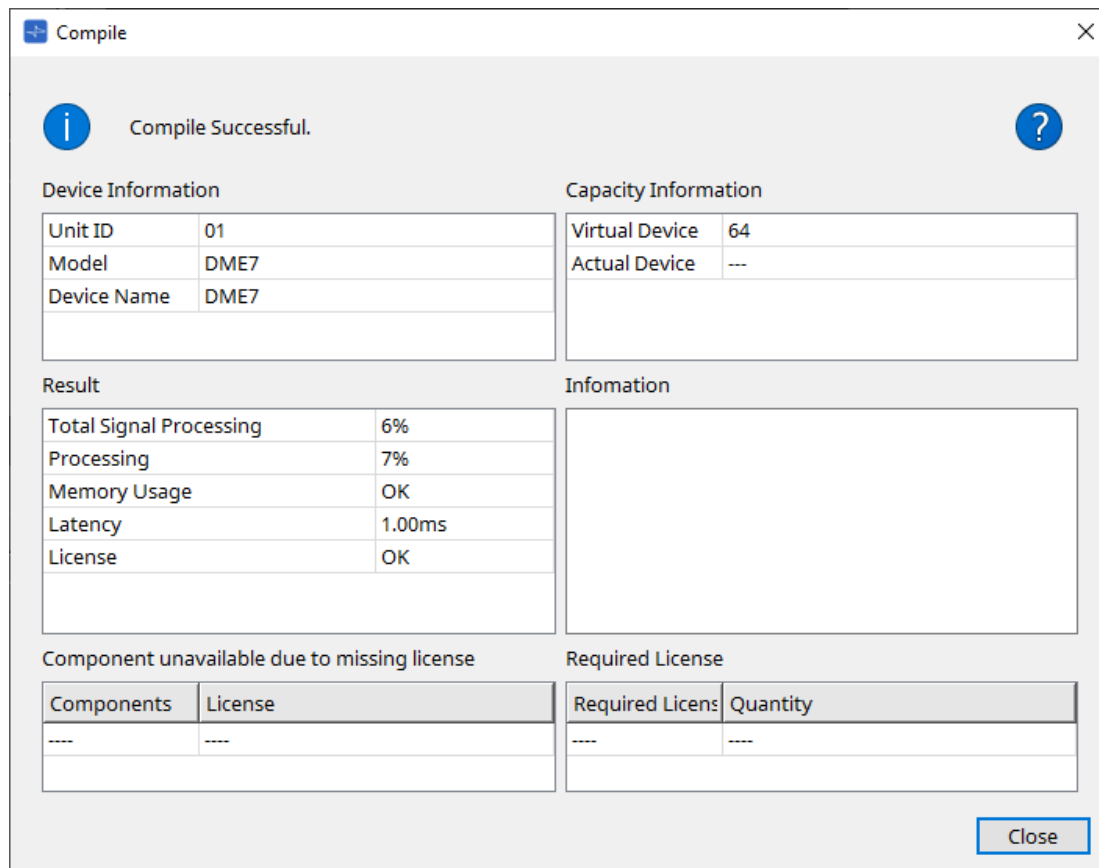

- **?** /Message  
Indicates whether compilation was successful or failed. If it was successful, the message "Compile Successful." will appear. If it failed, the message "Failed to Compile." will appear.
- **?** button  
Click here to view the troubleshooting method.
- **[Device Information]**  
This area displays information about the device.
- **Device list**
  - **Unit ID / Model / Device Name**  
These rows indicate the device Unit ID, device model name, and device name.  
To change the device name, use the [Device Name] field in the "Properties" area of the "Project" sheet.
- **[Capacity Information]**
  - **Virtual Device**  
This field indicates the signal processing capacity that is specified in the Capacity field of the device's "Properties" area.
  - **Actual Device**  
This field indicates the actual signal processing capacity of a device that has been detected by ProVisionaire Design.

If this field indicates a value, compilation will be executed based on this signal processing capacity.

- **[Result]**

This area displays the result of compilation. The DME7 can come online only when compilation is successful.

- **Total Signal Processing**

Indicates the usage rate of all the signal processing units in the device.

(Supplemental information) The device processes signals using its multiple signal processing units.

The "Total Signal Processing" row indicates the percentage of actual capacity being used (usage rate) based on the aggregated maximum signal processing capacity of all signal processing units as 100%.

- **Processing**

Indicates the maximum usage rate of each signal processing unit in the device.

The longer the signal path becomes, or the higher the number of inputs and outputs the component features, the higher the usage rate might become.

- **Memory Usage**

If the device's memory usage exceeds the amount of allowable memory, this field will indicate "NG."

- **Latency**

Indicates the latency of audio signals passing from the Dante input to the Dante output on the DME7 unit.

(Supplementary information) Indicates the maximum latency on the signal path. Latency that occurs inside the component is not taken into consideration.

- **License**

Latency that occurs inside the component is not taken into consideration.

Indicates that there are too many or too few Device Licenses.

If this field indicates "NG," you might be able to resolve the issue by purchasing additional licenses. For more information, refer to the description in the "Required License" area.

- **[Information]**

This area displays detailed information on the compilation.

- **[Component unavailable due to missing license]**

This area displays the names of components that are not working, and the required license for the component.

- **[Required License]**

This area displays the title and the number of required licenses.

- **[Close] button**

Closes the dialog box.

The following is an example of what is displayed if compiling fails.

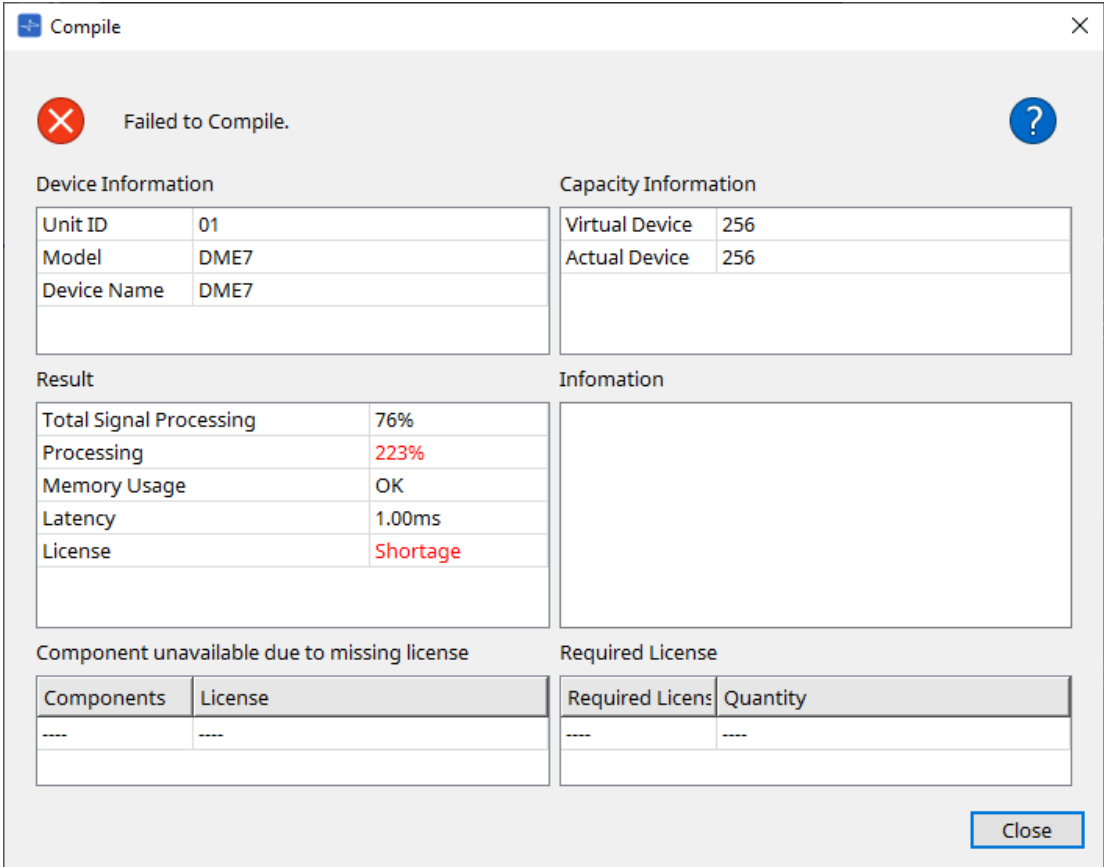

### 13.15.2. "Remote Control Setup List" dialog box

To open this dialog box, click [Remote Control Setup List] from the [Tools] button in the "Device" sheet. To control or monitor the DME7 using the SCP or YOSC communication protocol, you must register the parameters or meters to the Remote Control Setup List.



For more information on communication protocols, refer to the "DME7 Remote Control Protocol Specifications" or "DME7 OSC Specifications" that are posted on the Yamaha Pro Audio website.

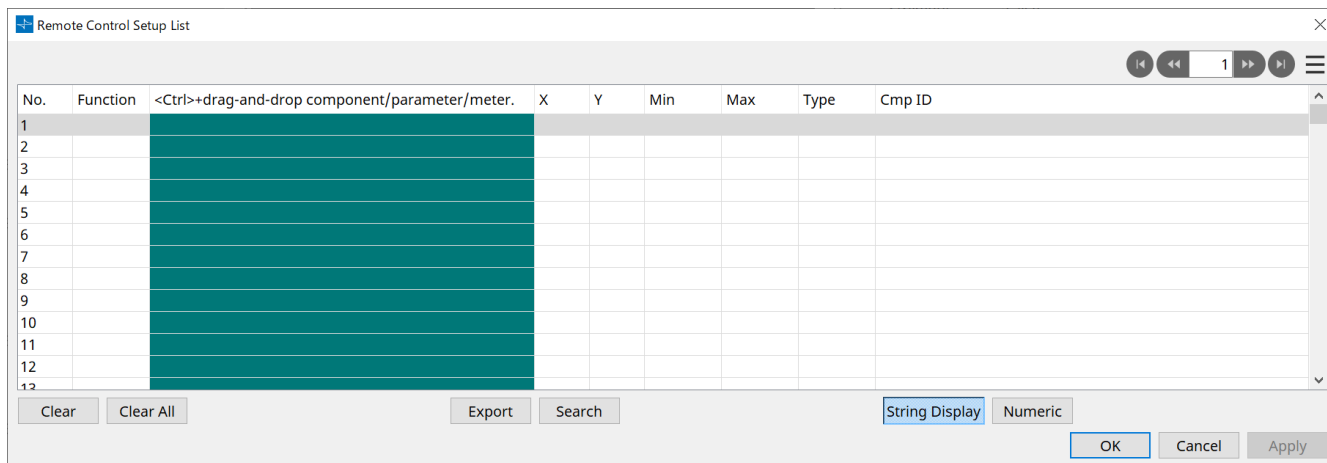

#### ■ Registering parameters or meters to the list

You can register parameters or meters to the lists using one of the following methods:

Registration source	Registration method
Design sheet	While pressing and holding down < Ctrl >, drag and drop a component to the list.
	Right-click a component, and then select [Add to Remote Control List].
Component editor/ Parameter setting window	<b>【Parameter】</b> While pressing and holding down < Ctrl >, drag and drop a parameter to the list. Right-click a parameter, and then select [Add to Remote Control List].
	<b>【Component】</b> Right-click anywhere other than a parameter, and then select [Add to Remote Control List].
"Parameters" area*1	Drag and drop a component or parameter to the list. Right-click a component or parameter, and then select [Add to Remote Control List].

\*1. You can also use < Shift > or < Ctrl > to simultaneously register multiple parameters in a list.

- If you add a component to the list, the following dialog box will appear.

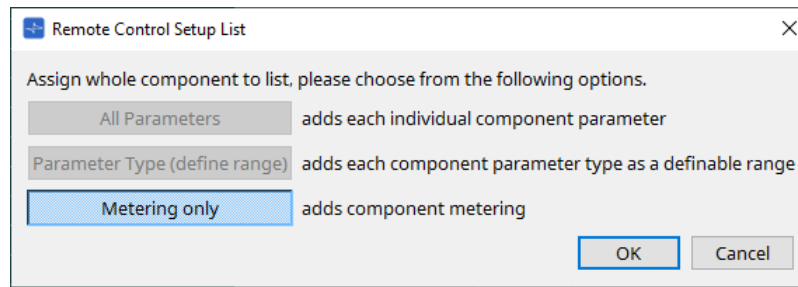

- **[All Parameters] button**  
Enables you to register all of the component's parameters.
  - **[Parameter Type (define range)] button**  
Enables you to register the component's parameters by type.  
Indicate the X value and Y value (such as channels) for the registered parameter.  
Use the external controller to specify channels for "any."  
For more information, refer to the "DME7 Remote Control Protocol Specifications."
  - **[Metering only] button**  
Enables you to register the component's meters by type.
- **[Function]**  
Shows the type of item that is registered in the list.
  - **[< Ctrl >+drag-and-drop component/parameter/meter.]**  
Shows the item that is registered in the list.
  - **[X]/[Y]**  
Indicate the X value and Y value (such as channels) for the registered parameter.  
You can change the channels after the parameter is registered.  
For an adjustable parameter, clicking this column opens a dialog box that enables you to modify the range.

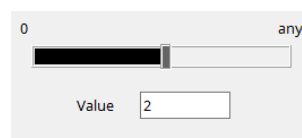

If you select "any," you will be able to specify the value via the controller.  
By specifying channels via the controller, you can reduce the number of parameters to be registered in the list. For more information, refer to the "DME7 Remote Control Protocol Specifications."

- **[Min]/[Max]**  
Enable you to specify the range of parameters that can be manipulated from the controller. In the case of level-type parameters for which a Min/Max value can be specified, clicking this will open a dialog box where you can specify the range.
- **[Type]**  
Shows the type of component that has the parameter registered in the list.
- **[Cmp ID]**  
Indicates the component ID. This ID appears at the end of the component name in the "Parameters" area.



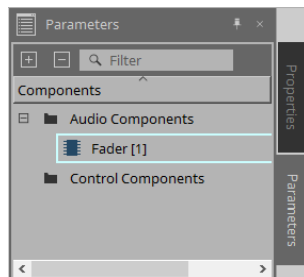

-  **button**  
Enable you to navigate pages back and forth.
- **Menu options that appear when you click the [☰] menu or right-click in the dialog box**
  - **Find**  
Opens the component editor for the parameter or meter on the currently-selected row.
  - **Cut**  
Cuts the currently-selected row.
  - **Copy**  
Copies the currently-selected row.
  - **Paste**  
Pastes the copied row.
  - **Insert**  
Inserts the copied row.
  - **Delete**  
Deletes the currently-selected row.
  - **Swap**  
Swaps the position of the currently-selected row.
- **[Clear] button**  
Clears the currently-selected row. You can use < Ctrl > or < Shift > to select multiple items.
- **[Clear All] button**  
Clears all registered parameters or meters.
- **[Export] button**  
Exports the list in .csv format file.
- **[Search] button**  
Opens the [“Search” dialog box for searching the list](#) in the “Remote Control Setup List” dialog box.
- **[String Display]/[Numeric] button**  
Switch view mode in the [MIN] and [MAX] columns.  
**String Display:** The format used in the component editor is displayed.  
**Numeric:** The internal value is displayed.
- **[OK] button**  
Enables the settings and closes the dialog box.
- **[Cancel] button**  
Closes the dialog box without updating the settings.
- **[Apply] button**  
Updates the new settings.

## ■ “Search” dialog box for searching the list

Use this when you want to search within the list of the “Remote Control Setup List” dialog box.

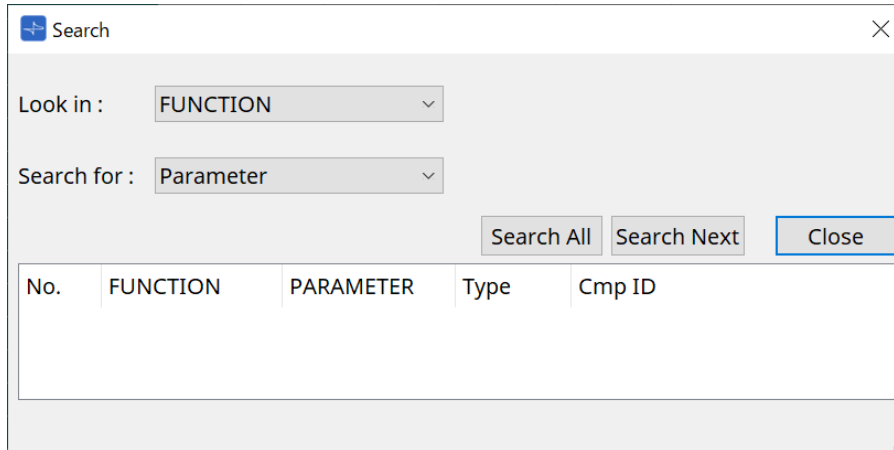

- **[Look In:] list box**  
Selects the location to search.
- **[Search for:] text box / list box**  
A list box appears if you selected [FUNCTION] in the [Look In:] list box; otherwise, a text box appears. Select the item to search, or enter text.
- **[Search All] button**  
Searches the list for the specified conditions, and shows the results below. When you click an item in the displayed search results, the focus moves to the corresponding item in the “Remote Control Setup List” dialog box.
- **[Search Next] button**  
Searches the list for the specified conditions, and moves the focus to the item that was found in the “Remote Control Setup List” dialog box. When you click this button again, the focus moves to the next search result item.
- **[Close] button**  
Closes the dialog box.

### 13.15.3. "SD Card File Manager" dialog box

To open this dialog box, click [SD Card File Manager] from the [Tools] button in the "Device" sheet.

This dialog box enables you to register a file you wish to play with the SD Card component.

The list in this dialog box is also used to play files via the DCP or GPI.

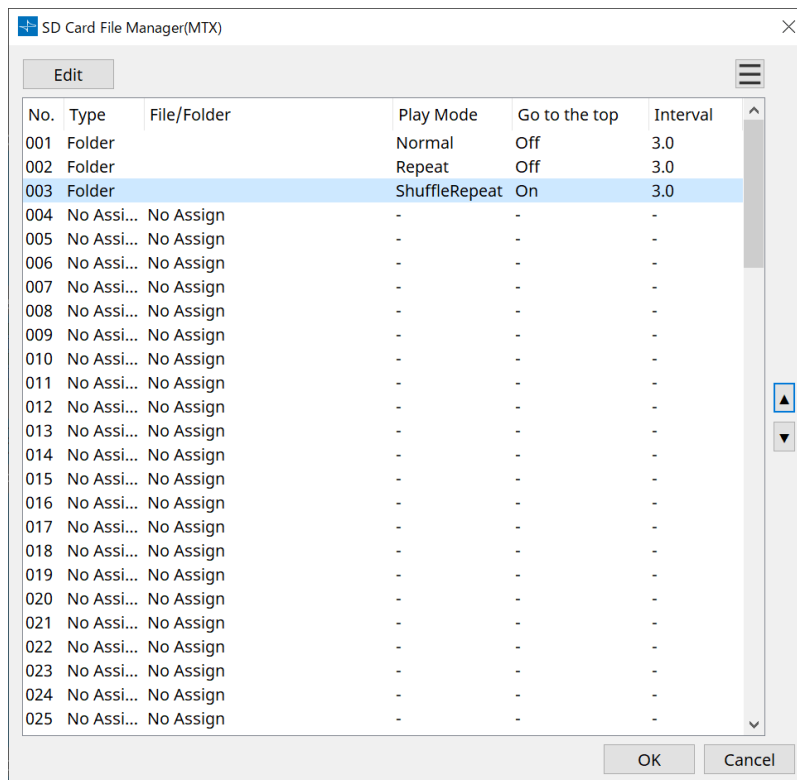

- **[Edit] button**

Click this button to open the "SD Card File Settings" dialog box.

- **Menu  button**

Click this button to open the following context menu.

- **Copy**

Copies the settings for the currently-selected row.

- **Paste**

Pastes the copied contents to the currently-selected row or to the "SD Card File Manager" dialog box for other devices.

- **Clear**

Deletes the settings for the currently-selected row.

- **Copy All**

Copies all settings.

- **Clear All**

Deletes all settings.

- **List**

If no file or folder is specified, "No Assign" appears.

- **No**

You can set from row 001 up to row 100.

- **Type**

If you selected "Play 1 Song" for "File/Folder" in the "SD Card File Settings" dialog box, "1 Song" will appear in this column. If you selected "Play all songs in a folder," "Folder" will appear in this column.

- **File/Folder**  
Indicates the file name or folder name.
- **Play Mode**  
Indicates the specified Play Mode.
- **Go to the top**  
Indicates the setting that was specified in the [Go to the top when playback stops] check box.
- **Interval**  
Indicates the interval time.
- **Up and down arrow  buttons**  
Change the position of the currently-selected row.
- **[OK] button**  
Saves the settings and closes the dialog box.
- **[Cancel] button**  
Closes the dialog box without saving the changes.

### "SD Card File Settings" dialog box

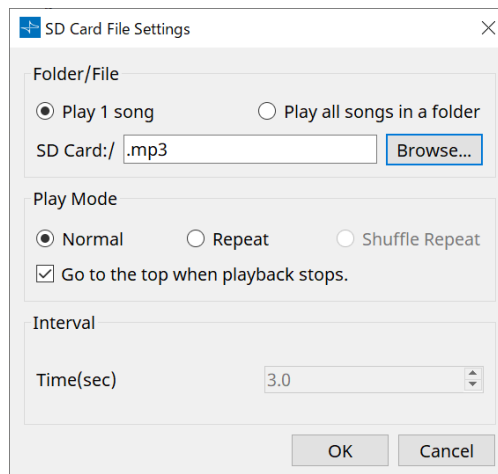

#### **【Folder/File】**

Specifies the file to play.

- **[Play 1 song] / [Play all songs in a folder] option button**  
If you choose [Play 1 song], only the file currently selected in [SD CARD:/] will play.  
If you select [Play all songs in a folder], all files saved in the folder selected by [SD CARD:/] will play.
- **[SD CARD:/]**  
This shows the name of the file or folder that will be played. You can change the name, or enter it directly.  
If [Play 1 song] is selected  
The following file and folder formats can be shown.
  - (folder name)\(file name).mp3
  - (folder name)\(file name).wav
  - (file name).mp3
  - (file name).wav

- **If [Play all songs in a folder] is selected**

The following folder formats can be shown.

- (folder name)
- blank



- Only first-level folders are valid.
- If the folder name is blank, all the files that exist in the root level of the SD memory card will be played (folders below the root level will not be included).

- **[Browse] button**

When you click this, a screen will appear, allowing you to select the file or folder to be played.

If you choose [Play 1 song], select a file.

If you choose [Play all songs in a folder], select a folder.

### **[Play Mode]**

- **[Normal]/[Repeat]/[Shuffle Repeat]**

This specifies the play mode for the file or files.

If you choose [Normal], the specified file or files in the folder will play once.

If you choose [Repeat], the specified file or files in the folder will play repeatedly.

If you choose [Shuffle Repeat], the files in the specified folder will play repeatedly in random order. If you choose [Play 1 song] in [Folder/File], the [Shuffle Repeat] setting will be unavailable.

- **[Go to the top when playback stops.] check box**

When you stop file playback, this specifies whether the file will pause at the location where you stopped or will return to the beginning of the file.

If this is On, playback will begin from the beginning of the file or the first file in the folder the next time you start playback.

If this is Off, playback will begin from the location at which you stopped the next time you start playback.

### **[Interval]**

This specifies the playback spacing when files are played consecutively.

- **Time (sec)**

You can set the time in the range from 0.0 sec to 10.0 sec in 0.1 sec steps.



- If an event to play another file is executed while the current file is still playing, the current playback will stop and the other file will start to play.

- **[OK] button**

Saves the settings and closes the dialog box.

- **[Cancel] button**

Closes the dialog box without saving the changes.

### 13.15.4. "GPI" dialog box

To open this dialog box, click [GPI] from the [Tools] button in the "Device" sheet.

GPI stands for General Purpose Interface. By using the GPI input/output, you can remotely control the DME7 via custom-made controllers or external devices. A controller that is connected to the GPI input connector can be used to switch snapshots on the DME7 or to control the parameters of components.

Display devices such as LEDs and lamps or external control equipment made by other manufacturers can be connected to the GPI output connector, letting you control the external device according to the state of presets or parameters.

For hardware-related details such as how to connect the [GPI] connector, refer to the owner's guide of each unit.

There are two methods to set up the GPI input.

- **Using the "GPI Input" dialog box, which you can access from the [Tools] button in the "Device" sheet.**

Use this method to execute a single function via a single port input.

- **Adding the GPI Input component to the Control layer in the "Device" sheet, and using the editor to set it up.**

Use this method if you wish to control multiple parameters or functions simultaneously via a single input port, or if you wish to manipulate a complex operation by combining multiple control components.

\* For GPI input, both the settings in the dialog box and the settings by the GPI Input component in the Control layer will be executed simultaneously.

There are two methods to set up the GPI output.

- **Using the "GPI Output" dialog box, which you can access from the [Tools] buttons in the "Device" sheet.**

Use this method to output a signal via a single output port based on a single operation as the factor.

- **Adding the GPI Output component to the Control layer in the "Device" sheet, and using the editor to set it up.**

Use this method if you wish to output a signal via a single output port based on multiple operations as the factor, or if you wish to execute a complex operation by combining multiple control components.

\* The Output Port Type setting is linked between this dialog box and the GPI Output component in the Control layer.

#### ■ Operations applied to both the "GPI Input" and "GPI Output" dialog boxes

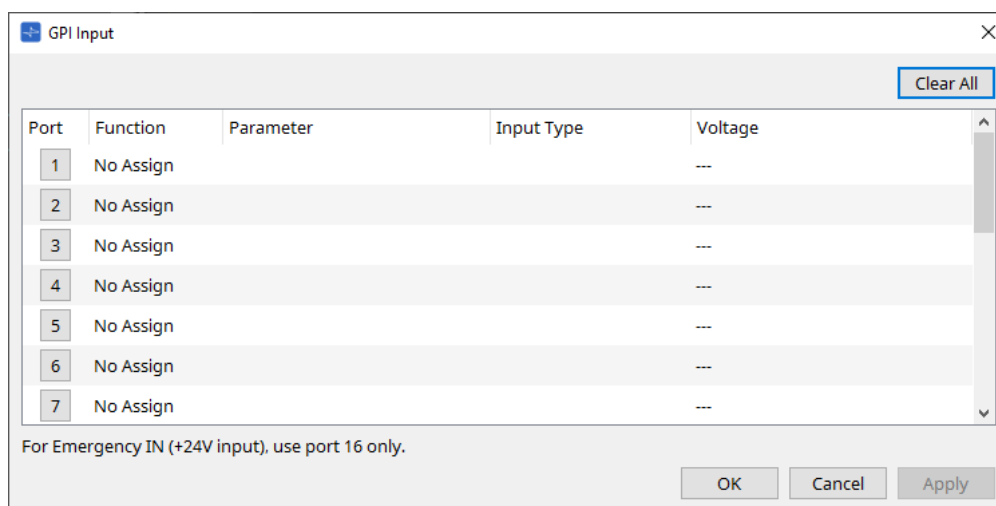

- **[Clear All] button**  
Initializes the settings of all ports.
- **[Port] select buttons**  
Click this button to open the "Settings" dialog box.
- **[OK] button**  
Applies the setting and closes the dialog box.

- **[Cancel] button**  
Discards the setting and closes the dialog box.
- **Function**  
Indicates the function assigned to the corresponding port.
- **Parameter**  
Indicates the parameter assigned to the corresponding port.

■ **Registering a parameter or snapshot**

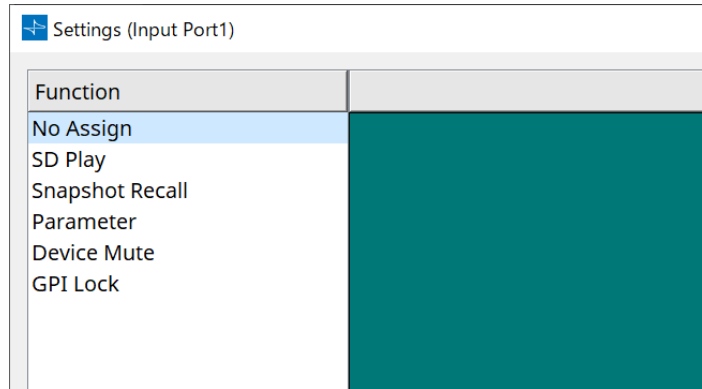

Drag and drop a snapshot or parameter to the green area. The Function column will automatically indicate the name of the corresponding function.

Registration source	Registration method
"Parameter Sets" area	Drag and drop a snapshot to the green area.
Component editor	While pressing and holding down < Ctrl >, drag and drop a parameter to the green area.
"Parameters" area	Drag and drop a parameter in the green area.

■ **[GPI Input] dialog box**

This dialog box explains how the [GPI IN] connectors on the device are configured.

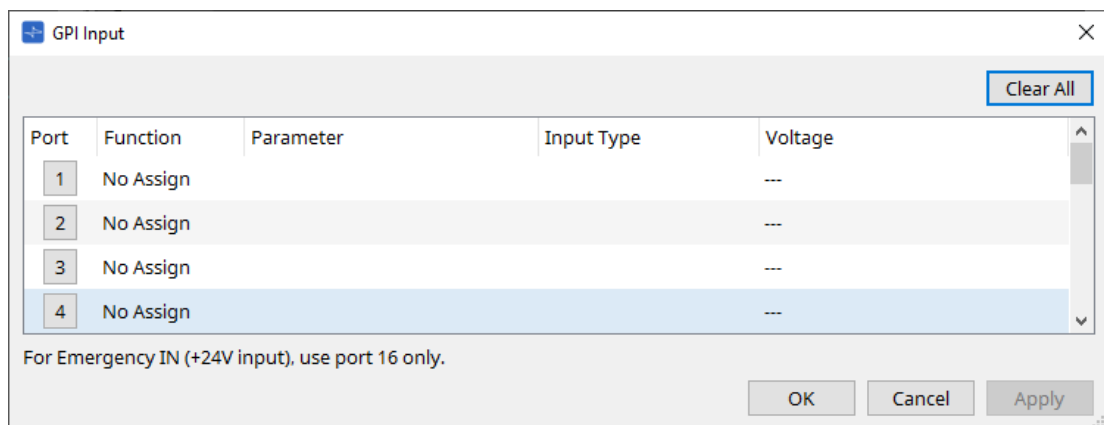

- **[Voltage]**  
Indicates the current input voltage value while the device is online.  
Only [GPI IN] connector #16 supports Emergency In (+24V input).

## Settings dialog box

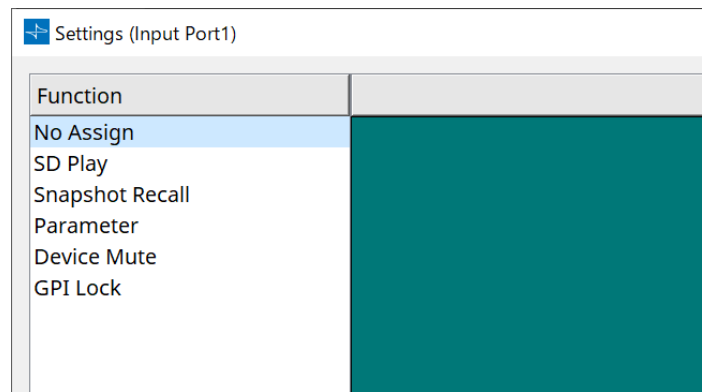

### Function

- **[SD Play]**
  - **SD Song Select & Play**  
Plays the file specified in the “SD Card File Manager” dialog box.
  - **SD Song Pause**  
Stops playing the file.
- **[Snapshot Recall]**  
Recalls the snapshot.
- **[Parameter]**  
Enables you to edit the assigned parameter.

#### When the Control Type is Parameter Value Edit

You can edit the assigned parameter within the specified range. Click the Lower Limit or Upper Limit field to display the operator.

#### When the Control Type is Direct Parameter Value

You can set the assigned parameter to a specified value. Click the Value field to display the operator.

- **[Device Mute]**  
Mutes the device.
- **[GPI Lock]**  
Any inputs from the [GPI IN] ports, other than those for which GPI Lock has been set, will be disabled.
- **[Emergency In]**  
Place the device in Emergency mode. Only port #16 supports Emergency mode.



- **Emergency mode**

The DME7 enters Emergency mode if it receives the SCP devmode emergency command, or when the input at [GPI IN] connector (IN 16) (which supports +24V) falls below 2.5V. In this mode, the unit will operate as follows.

- The unit recalls the snapshot that was specified for [Emergency Recall] which can be accessed from [Parameter Sets]. When Emergency mode is cleared, the device returns to the status obtained prior to recall.
- Operations from an external controller such as a DCP will no longer be received.
- The unit will be taken offline from ProVisionaire Design.

## ■ Input Type

### Connection examples using the [GPI IN] connector

- **Connection example 1:  
Controlling the DME7 with a switch**

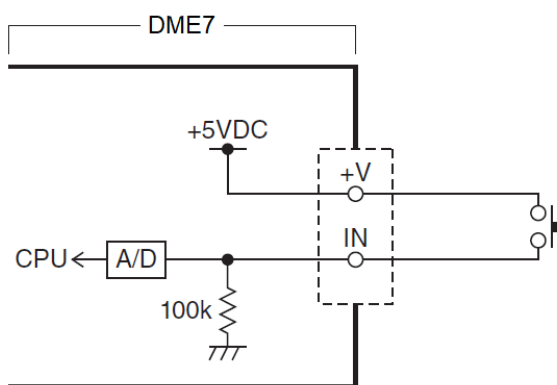

- **Connection example 2:  
Controlling the DME7 with a 10kΩ B-curve variable resistor**

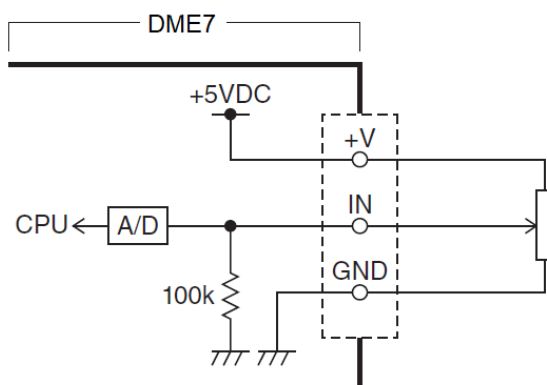

- [INPUT TYPE] allows the following settings.

- ↗ Analog
- ↘ Analog Inv.
- ↗ High Active
- ↘ Low Active
- ↗ Rising Edge
- ↘ Falling Edge



- The threshold value at which on/off switching will occur will be the middle value between the maximum and minimum input voltage values (the value equal to the sum of the maximum and minimum values divided by two). To prevent malfunctions, you should allow plenty of room for detection (see “GPI Calibration” dialog box).
- If the voltage has dropped because of cable length or noise, use the “GPI Calibration” dialog box to adjust the maximum and minimum input voltage values. Since voltage may become unstable, configure and set up your external circuit to ensure that there is ample distance between the maximum and minimum values.

### 【↗ Analog】

You can select this option if you assigned a continuously-changing parameter to the [Parameter Value Edit] category.

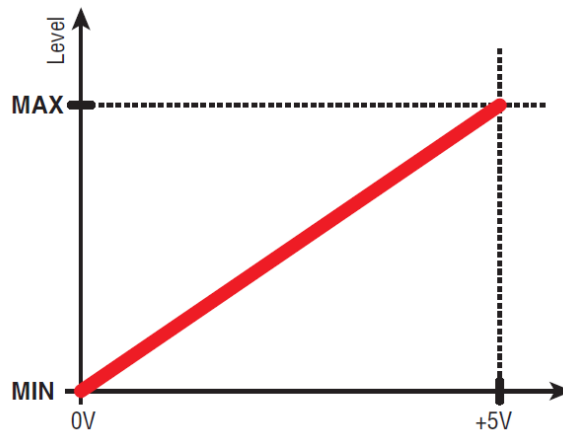

- The level will be at the maximum value when the input voltage to the GPI IN is at maximum (5V), and at the minimum value when the input voltage is at minimum (0V).

### 【↘ Analog Inv.】

You can select this option if you assigned a continuously-changing parameter to the [Parameter Value Edit] category.

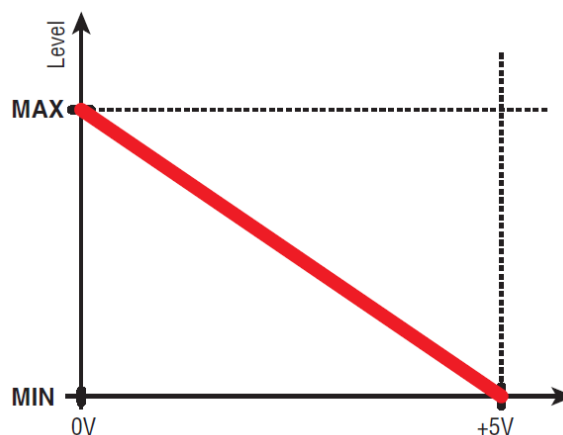

- The level will be at the minimum value when the input voltage to the GPI IN is at maximum (5V), and at the maximum value when the input voltage is at minimum (0V).

### 【↗ High Active】

You can select this option if one of the following functions was assigned.

- Device Mute
- GPI Lock

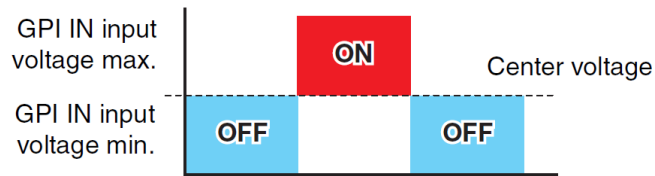

- The function will turn on when the input voltage to GPI IN rises above the center voltage, and will turn off when it falls below the center voltage.

#### 【↵ Low Active】

You can select this option if one of the following functions was assigned.

- Device Mute
- GPI Lock

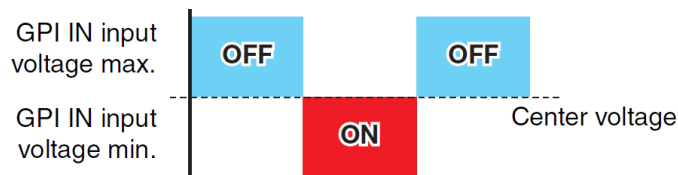

- The function will turn off when the input voltage to GPI IN rises above the center voltage, and will turn on when it falls below the center voltage.

#### 【⬆ Rising Edge】

You can select this option if one of the following functions was assigned.

- On/Off
- SD Song Select & Play/ SD Song Pause
- Snapshot
- Parameter > Direct Parameter Value
- Device Mute
- GPI Lock

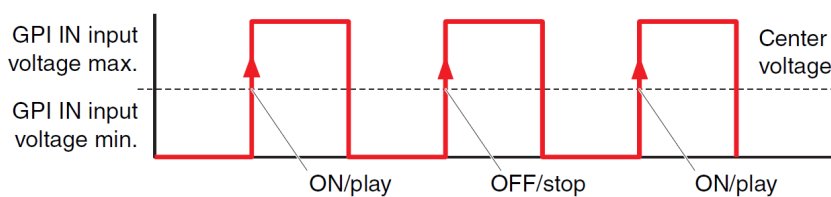

- The assigned function will be executed if the input voltage to the [GPI IN] connector rises from below to above the middle voltage value.

#### 【⬇ Falling Edge】

You can select this option if one of the following functions was assigned.

- On/Off
- SD Song Select & Play/ SD Song Pause
- Snapshot
- Parameter > Direct Parameter Value
- Device Mute
- GPI Lock

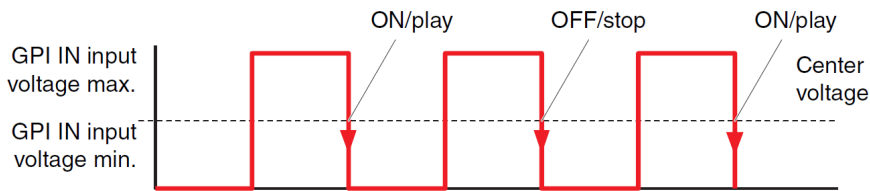

- The assigned function will be executed if the input voltage to the [GPI IN] connector falls from above to below the middle voltage value.

### ■ GPI Output dialog box

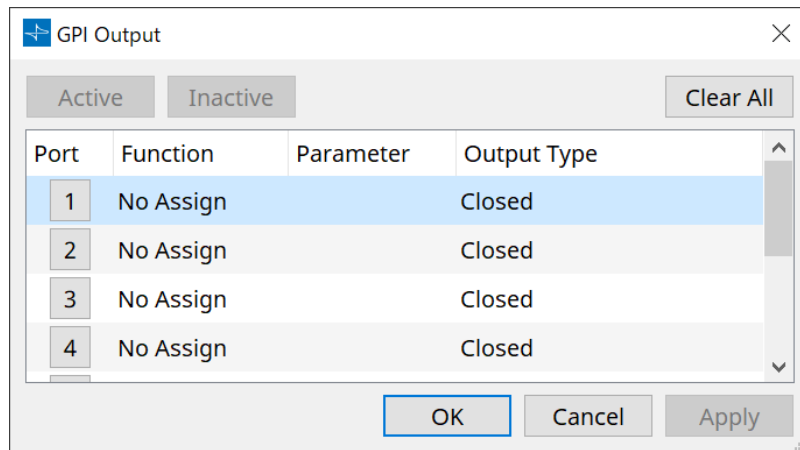

- **[Active] button, [Inactive] button**

Press this button while the device is online to output at the GPI output a test signal according to the Output Type setting.  
For more information, refer to the explanation in the Output Type section.

### Settings dialog box

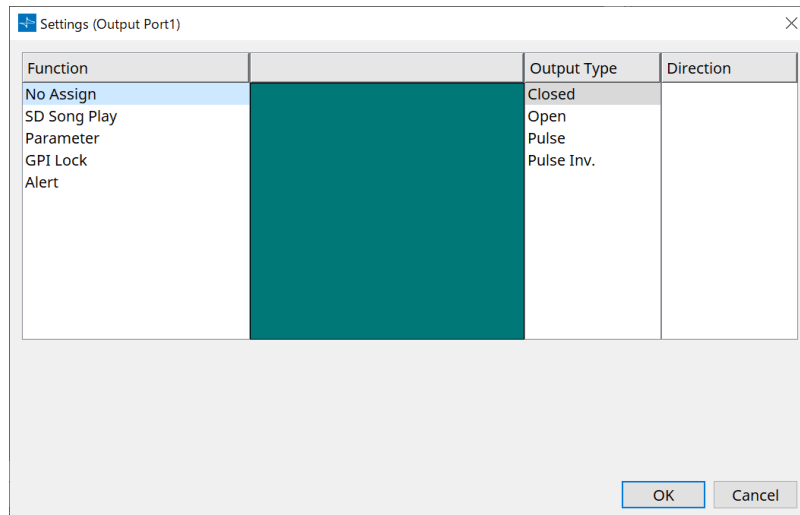

### Function

- **[SD Song Play]**

The command will be output from the [GPI OUT] connector when an SD card file starts to play.

- **[Parameter]**

The command will be output at the [GPI OUT] connector when the parameter value reaches the specified status.

- **[GPI Lock]**

The GPI Lock status will be output at the [GPI OUT] connector.

- **[Alert]**

The command will be output at the [GPI OUT] connector when a specified alert occurs.

## ■ Output Type

### Connection examples using the [GPI OUT] connector

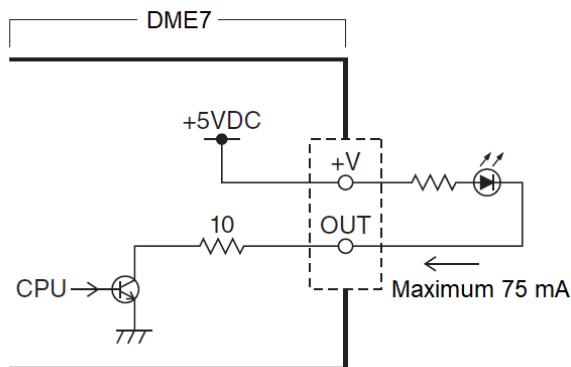

- [OUTPUT TYPE] allows the following settings.

- Closed
- Open
- Pulse
- Pulse Inv.

- **Closed**

When the selected [Function] state occurs, the contact will be closed.

If [Parameter Value Edit] is selected, the contact will be closed when the specified threshold is exceeded.

If [Direct Parameter Value] is selected, the contact will be closed when the specified value is reached.

- Press the [Active] button to close the contact.
- Press the [InActive] button to open the contact.

- **Open**

When the selected [Function] state occurs, the contact will be opened.

If [Parameter Value Edit] is selected, the contact will open when the specified threshold is exceeded.

If [Direct Parameter Value] is selected, the contact will open when the specified value is reached.

- Press the [Active] button to open the contact.
- Press the [InActive] button to close the contact.

- **Pulse**

If the [Direction] is [Upward], the contact will change from closed to open for approximately 250 ms when the selected [Function] state occurs.

If [Parameter Value Edit] is selected, the contact will change from open to closed for approximately 250 ms when the value exceeds the threshold.

If the [Direction] is [Downward], the contact will change from closed to open for approximately 250 ms when the selected [Function] state is cleared.

If [Parameter Value Edit] is selected, the contact will change from open to closed for approximately 250 ms when the value falls below the threshold.

- Press the [Active] button to open the contact for 250 ms.
- The [InActive] button is disabled.

- ** Pulse Inv.**

If the [Direction] is [Upward], the contact will change from closed to open for approximately 250 ms when the selected [Function] state occurs.

If [Parameter Value Edit] is selected, the contact will change from closed to open for approximately 250 ms when the value exceeds the threshold.

If the [Direction] is [Downward], the contact will change from closed to open for approximately 250 ms when the selected [Function] state is cleared.

If [Parameter Value Edit] is selected, the contact will change from closed to open for approximately 250 ms when the value falls below the threshold.

- Press the [Active] button to open the contact for 250 ms.
- The [InActive] button is disabled.

### 13.15.5. "MIDI" dialog box

To open this dialog box, click [MIDI] from the [Tools] button in the "Device" sheet.

You can control the DME7 via MIDI. You can also control the setting from the DME7.

In addition, you can edit the settings while the device is online.

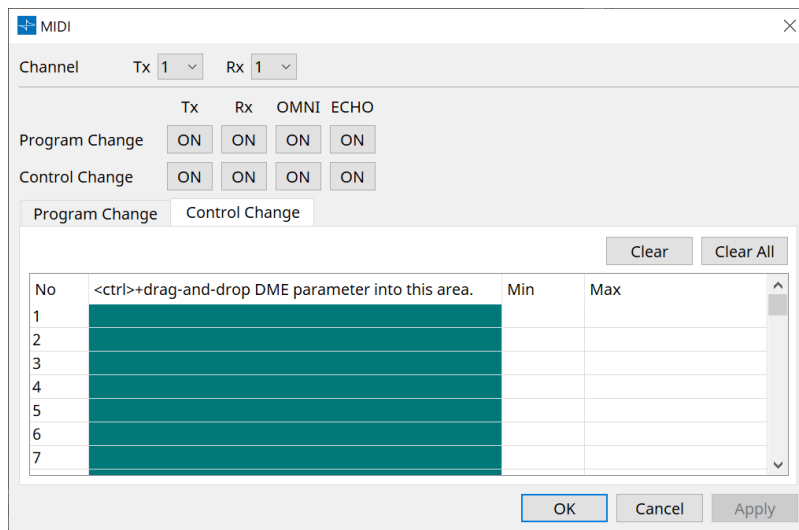

#### ■ Assigning items to the list

You can assign items to the list using one of the following methods.

Registration source	Registration method
"Parameter Sets" area	Drag and drop a snapshot to the green area of the "Program Change" screen.
Component Editor	While pressing and holding down < Ctrl >, drag and drop the parameter to the green area of the "Control Change" screen.
"Parameter Sets" area	Drag and drop the parameter to the green area of the "Control Change" screen.

#### ■ Common MIDI settings

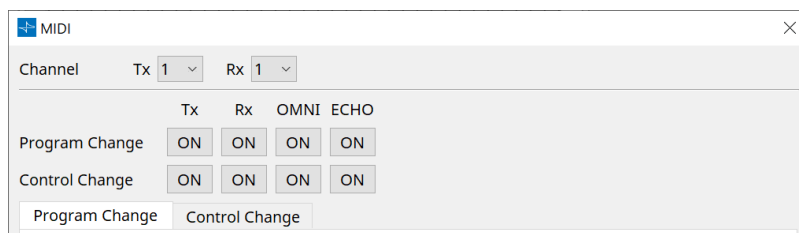

##### • Channel

- **Tx**  
Select from the MIDI transmit channels (1-16).
- **Rx**  
Select from the MIDI receive channels (1-16).
- **Program Change**  
Enables you to turn the Program Change Tx (transmit channel) and Rx (receive channel) on or off. If OMNI is [ON], all Program Change messages will be received regardless of the receive channel setting. (This applies only to the receive channels. A single channel will be used for transmission.)

If ECHO is [ON], any Program Change messages that are received from an external device will be output unchanged.

- **Control Change**

Enables you to turn on or off the Control Change TX (transmit channel) and Rx (receive channel). If OMNI is [ON], all Control Change messages will be received regardless of the receive channel setting. (This applies only to the receive channels. A single channel will be used for transmission.) If ECHO is [ON], any Control Change messages that are received from an external device will be output unchanged.

- **Program Change/Control Change switching tabs**

These tabs switch between the Program Change setting screen and the Control Change setting screen.

- **[Clear] button**

Clears the settings for the currently-selected row.

- **[Clear All] button**

Clears the settings for all rows.

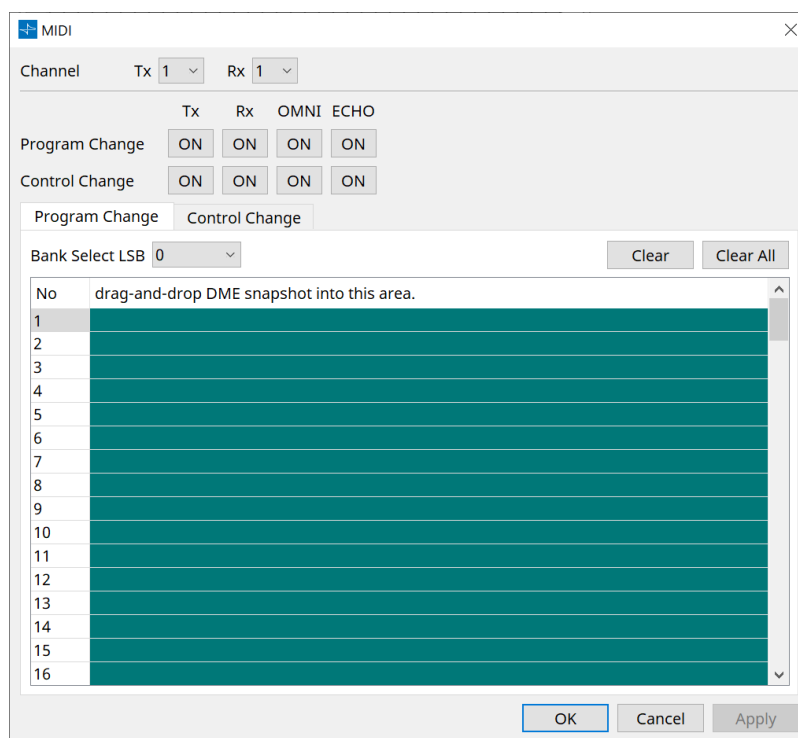

### ■ [Program Change] tab

Assigns snapshots to program control change numbers 1 through 128. Switches scenes when program changes are received. Up to 999 assignments can be made. Snapshots above number 128 are assigned by changing banks.

- **[Bank Select LSB] button**

Banks 0-7 are available. Select from 001 to 128 for each bank.

- **Program Change list**

The list in the middle indicates the Program Change numbers and the current setting.

- **No.**  
Indicates the Program Change number.
- **Drag-and-drop Snapshot into this area.**  
Indicates the name of registered snapshots.



## ■ [Control Change] tab

Assigns components to control change for each DME. You can change DME parameters by sending control change messages from external equipment.

You can assign to control change numbers 1-31, 33-95, and 102-119.



Because control change numbers 0 and 32 are used for bank select MSB, numbers 96-101 are RPN/NRPN related, and 120-127 are used for mode messages, they cannot be used for component assignment.

### • Control Change List

The control change numbers and current settings are displayed in the list in the center.

- **No.**  
Displays the control change numbers.
- **< Ctrl >+drag-and-drop DME parameter into this area.**  
Indicates the name of registered parameters.
- **Min/Max**  
Enables you to specify the editable range of parameters. Click the field to display the operator. You can change the parameter by dragging the slider.

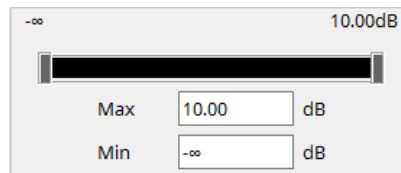

## 13.16. Message List

Messages displayed on the DME7 display and countermeasures are as follows.

Data ID	Data Name	Message [Normal]	Message [Warning]	Message [Error]	Message [Fault]
30002	EXT TEMP Limit	-	Environmental temperature exceeded device upper limit. Please check air flow.	-	-
30009	FAN Rotation Error	-	FAN rotation speed out of control. Please check that fan rotation is not obstructed by some external impediment.	-	FAN stopped. Please contact Yamaha service personnel.
30010	Fan Lifespan Warning	-	FAN will soon reach end of expected lifespan. Please contact Yamaha service personnel.	-	-
30011	Low Battery	-	Remaining battery charge is low. Please replace.	Battery charge will soon be exhausted. Please replace.	No battery charge remaining. Some part of data cannot be preserved correctly.
30022	Leader W/C Unlock	-	-	Wrong word clock detected on leader word clock source.	-
30024	Storage Lifespan Warning	-	Storage device will soon reach end of expected lifespan. Please contact Yamaha service personnel.	-	-
30025	Storage Access Error	-	Error occurred whilst writing data to storage.	-	Error occurred while writing data to storage. Please contact Yamaha service personnel.
30026	IP Address Duplicate	-	-	IP Address collision detected.	-

Data ID	Data Name	Message [Normal]	Message [Warning]	Message [Error]	Message [Fault]
30033	Dante Module Error	-	-	-	Dante module is not responding. Please try to recover Dante firmware or contact Yamaha service personnel.
30034	No Dante Connection	-	No network is connected to the Dante port. Please check the Dante connection.	-	-
30037	Wrong Dante Clock	-	Dante word clock settings are wrong. Please check the settings.	-	-
30038	Muted - Dante Clock Err.	-	-	Muted due to incorrect Dante word clock settings. Please check Dante word clock settings.	-
30039	Dante Clock Offset Err.	-	Dante Clock Frequency Offset is unstable. Please check network configuration including Ethernet switch settings.	-	-
30040	Dante Redundancy Triiggered	-	Dante Audio transmission has switched to Secondary network.	-	-
30041	Dante Secondary Error	-	The Dante secondary port is not functioning.	-	-
30047	Power ON	Power ON	-	-	-
30049	Device Initialized	Memory initialization performed.	-	-	-
30050	Time Synchronized	Date and time is synchronized.	-	-	-
30051	Firmware Updated	Firmware update performed.	-	-	-
30052	Scene/Snapshot Store	Scene/Snapshot store performed.	-	-	-

Data ID	Data Name	Message [Normal]	Message [Warning]	Message [Error]	Message [Fault]
30053	Scene/Snapshot Recall	Scene/Snapshot recall performed.	-	-	-
30056	PSU Switched Over	-	Either Redundant Power Supply "A" or "B" failed. Please check power cables and source.	-	-
30057	Dante Link 100Mbps	-	Dante link speed is less than Gigabit. Try plugging into a different network switch or a different port. Alternatively, try using a different network cable.	-	-
30058	Sub Module Error	-	-	-	Internal sub module is not responding. Please contact Yamaha service personnel.
30059	Sub Module Rebooted	-	-	Internal sub module has rebooted unintentionally.	-
30060	Illegal MAC address	-	-	-	Illegal MAC address has been detected at control ethernet interface. Please contact Yamaha service personnel.
30061	Dante MAC Address Err.	-	-	-	Illegal MAC address has been detected at Dante ethernet interface. Please contact Yamaha service personnel.
30062	IP Address Assigned	IP address is assigned to the network interface.	-	-	-
30063	IP Address Assigned (Auto IP)	IP address is assigned (AutoIP) to the network interface.	-	-	-

Data ID	Data Name	Message [Normal]	Message [Warning]	Message [Error]	Message [Fault]
30064	IP Address Released	IP address assigned by DHCP server is released.	-	-	-
30065	Internal Network Error	-	-	Unable to establish connection with internal sub module due to incorrect network address.	-
30066	Dante (TX) Overflow	-	-	Dante Audio Flow Resource (TX) exceeded. Please re-design Dante patch to match Dante Flow resources.	-
30067	Dante (RX) Overflow	-	-	Dante Audio Flow Resource (RX) exceeded. Please re-design Dante patch to match Dante Flow resources.	-
30068	Dante Settings Locked	-	Unable to apply Dante setting changes to the Dante module due to Dante Device Lock or DDM permission settings.	-	-
30069	DCP Comms Error	-	-	Communication error is detected during the communication sequence between host device and DCPs. Please make sure that the following are within specification: 1) cable length, 2) cable quality, 3) the final DCP in the chain is terminated.	-

Data ID	Data Name	Message [Normal]	Message [Warning]	Message [Error]	Message [Fault]
30070	DCP Configuration Error	-	-	Unable to communicate with connected DCPs correctly. Please check if 1) Panel ID's are correctly set 2) Pre-configured DCP type and real DCP type connected by wire is identical.	-
30071	DSP Resource Overflow	-	-	The resource for audio signal processing is unexpectedly overflowed, which might cause audible noise.	-
30072	Incompatible Data/File	-	-	Unable to Load/Import Data/File due to incompatible data format.	-
30073	Incompatible RC Protocol	-	-	Unable to communicate/respond to external remote control device/software due to incompatible protocol version.	-
30074	DHCP Server No Response	-	-	DHCP server is not responding to the device.	-
30075	NTP Server No Response	-	-	NTP server is not responding to the device.	-
30076	Missing License	-	-	Some or entire functions of this device stop working due to missing or insufficient licenses. Please activate additional licenses or remove corresponding functions.	-

Data ID	Data Name	Message [Normal]	Message [Warning]	Message [Error]	Message [Fault]
30077	Setting Data Corrupted/Lost	-	-	Corrupted data/file is detected.	-
30078	Storage Full	-	-	Storage Full.	-
30079	Unsupported File System	-	-	The storage drive is formatted with unsupported file system type. Please re-format the storage to a supported format.	-
30080	Removable Drive Mounted	Removal drive has been mounted to device.	-	-	-
30081	Removable Drive Unmounted	Removal drive has been unmounted from device.	-	-	-
30082	File Not Found	The file cannot be found.	-	-	-
30083	Authentication Failed	-	Wrong PIN code/Password was entered.	-	-
30084	Panel Locked	The operation panel is locked.	-	-	-
30085	Panel Unlocked	The operation panel is unlocked.	-	-	-
30086	Scene/Snapshot Recall Failed	-	-	Failed to recall the Scene/Snapshot data.	-
30087	Data Sync Failed	-	-	Synchronization sequence has been stopped unexpectedly.	-

---

# 14. Audio Processor MRX7-D

## 14.1. Overview

The MRX7-D is a free-configuration type processor that allows you to easily and freely design your system by arranging the components you want.

The MRX7-D can be operated using an external controller such as the DCP or MCP1. PGM1 can be used to build a paging system.

The MRX7-D device sheet allows you to freely place [components](#), wire the components together, and [compile](#). After that, communicate with the MRX7-D main unit to set parameters using the [component editor](#) or other software.

Parameters are stored and recalled in snapshot format.

The parameters that you want to store and recall can be grouped ([parameter set](#)), and ten parameter value patterns can be stored as snapshots for each parameter set.

Snapshots can be registered to [presets](#) and recalled from the front panel of the main unit along with DCP and other equipment.

Multiple snapshots can be grouped together ([snapshot group](#)) and registered in a single preset. Snapshots and snapshot groups can be recalled from the remote controller.

Multiple parameters can be linked ([parameter link groups](#)).

They can be linked for each component ([gang edit group](#)).

Information such as the initial values of components, components, and wires between components can be stored in the computer in the form of [user styles](#). Remembering user styles frees you from having to change settings each time you place a component. User styles can also be exported to other computers.

The wires between components can be converted to blocks as a [User Defined Block](#). By combining multiple components into a single block, you can clean up the look of the stylesheet and easily create the same functionality for different channels by copying blocks. By setting "View Only" mode or "Protect" mode for each block, you can protect the block when you run "Protect User Defined Block".



## 14.2. Project Sheet

This is the sheet on which devices are placed. When placing devices, the Settings screen shown below is displayed.

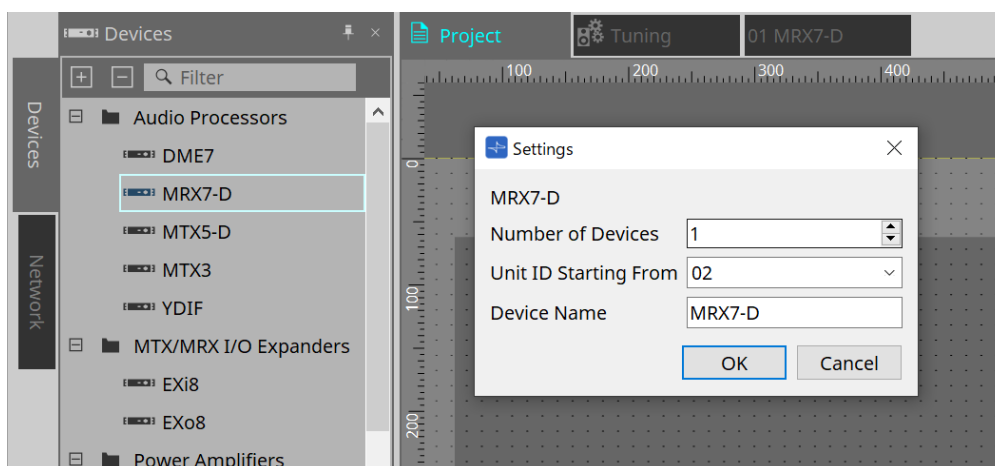

- **Number of Devices**  
Selects the number of MRX7-D units to be placed on the sheet.
- **Unit ID Starting From**  
The starting number for the device Unit IDs can be selected.
- **Device Name**  
The device name can be displayed and edited.

### 14.2.1. Toolbar

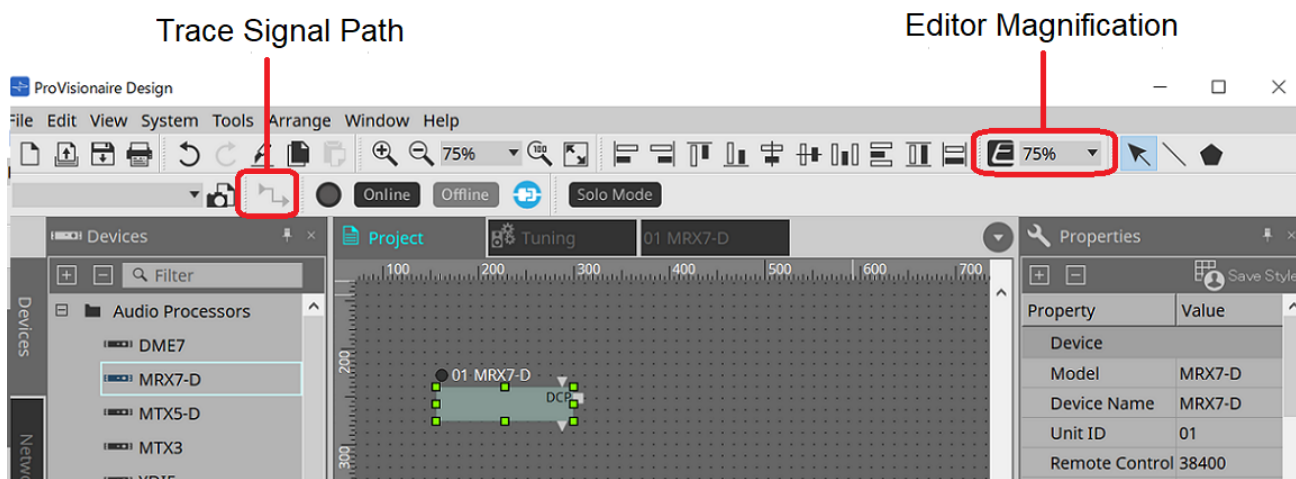

- **Editor Magnification**  
Changes the magnification of the component editor.
- **Trace Signal Path**  
When this is turned on, when a port or wire is selected, the signal path will be searched in the output and input directions starting from the selected point.

## 14.2.2. Devices Area

If "YDIF" is added to the project, an example of connecting multiple devices by YDIF terminals is displayed. The word clock setting is also performed automatically.

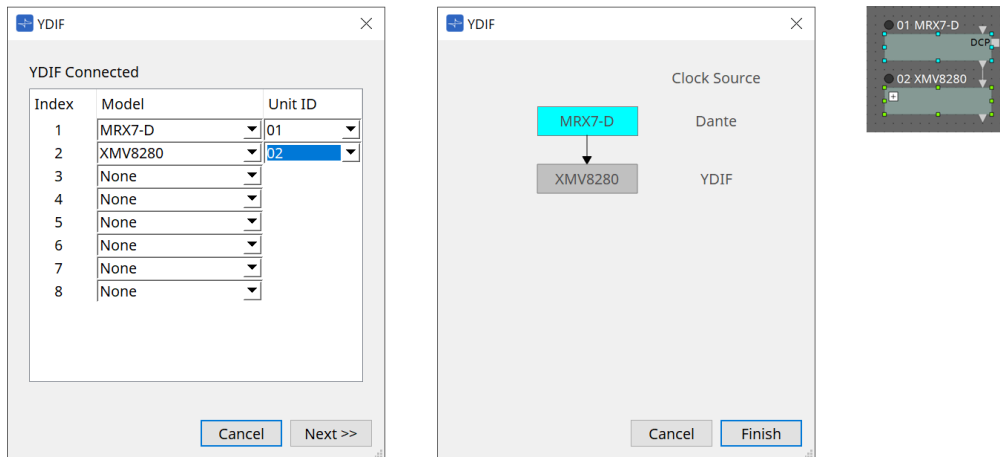

### 14.2.3. Properties Area

Displays/edits the MRX7-D information.

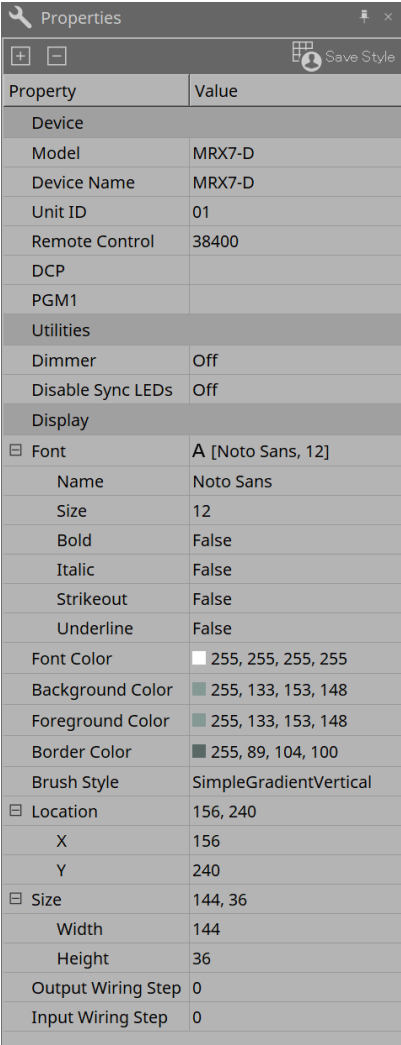

Property	Value
<b>Device</b>	
Model	MRX7-D
Device Name	MRX7-D
Unit ID	01
Remote Control	38400
DCP	
PGM1	
<b>Utilities</b>	
Dimmer	Off
Disable Sync LEDs	Off
<b>Display</b>	
Font	A [Noto Sans, 12]
Name	Noto Sans
Size	12
Bold	False
Italic	False
Strikeout	False
Underline	False
Font Color	255, 255, 255, 255
Background Color	255, 133, 153, 148
Foreground Color	255, 133, 153, 148
Border Color	255, 89, 104, 100
Brush Style	SimpleGradientVertical
Location	156, 240
X	156
Y	240
Size	144, 36
Width	144
Height	36
Output Wiring Step	0
Input Wiring Step	0

#### Device

- **Unit ID**

Match this to the Unit ID of the MRX7-D main unit. The factory default setting is 1.

- **Remote control**

Confirm the port number when connecting an external controller, and configure the settings when connecting an external controller to RS-232C.

The Remote Control dialog is displayed from the  that is displayed when the Value field in Properties is clicked.

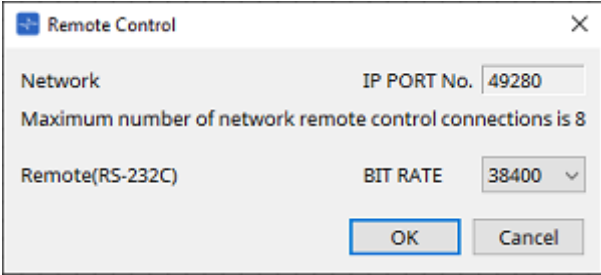

Remote Control	
Network	IP PORT No. 49280
Maximum number of network remote control connections is 8	
Remote(RS-232C)	BIT RATE 38400
<input type="button" value="OK"/> <input type="button" value="Cancel"/>	

- **[Network IP PORT No.]**

Displays the port number of the MRX7-D's NETWORK terminal. Up to 8 external controllers can be connected to the terminals.

- **[Remote (RS-232C) BIT RATE] List Box**

Selects the RS-232C communication speed. 38400 bps or 115200 bps can be selected.  
One external controller can be connected to the RS-232C connector.

- **[OK] Button**

Saves the settings and closes the dialog.

- **[Cancel] Button**

Closes the dialog without changing the settings.

- **DCP**

Selects the DCP to be connected to the MRX7-D DCP port.

When a DCP is selected, that DCP is connected to the MRX7-D and the DCP component is added to the device sheet.

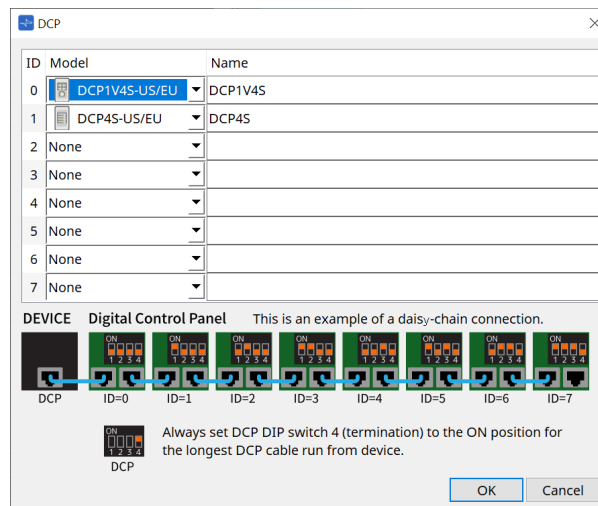

Parameter assignments are performed in the [DCP component editor](#).

- **PGM1**

Specifies the Unit ID for the PGM1 that is controlling the MRX7-D.

The PGM1 dialog is displayed from the  that is displayed when the Value field in Properties is clicked.  
For details, refer to the MTX5-D [Paging setting flow](#).

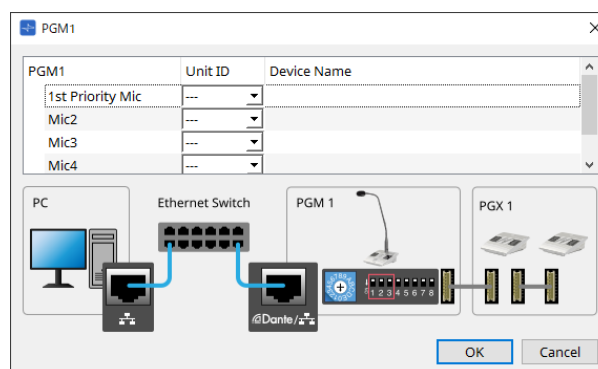

The MRX7-D retains the PGM1 settings data, so there is no problem with the configuration even if PGM1 is not discovered in ProVisionaire Design.

When updating the PGM1's firmware or changing the IP address, please install Bonjour Print Service and allow ProVisionaire Design to discover the device.

For other items, please check the explanation displayed when the Properties item is selected.

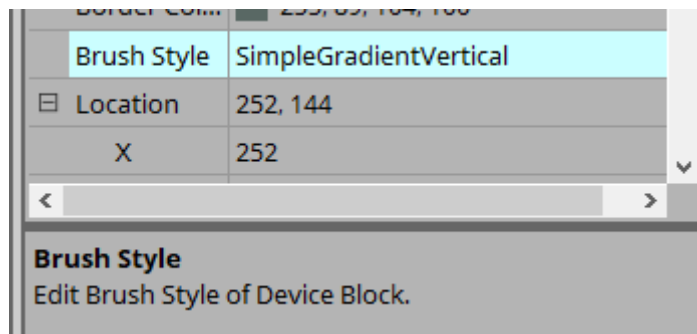

## 14.3. Device Sheet Screen Configuration

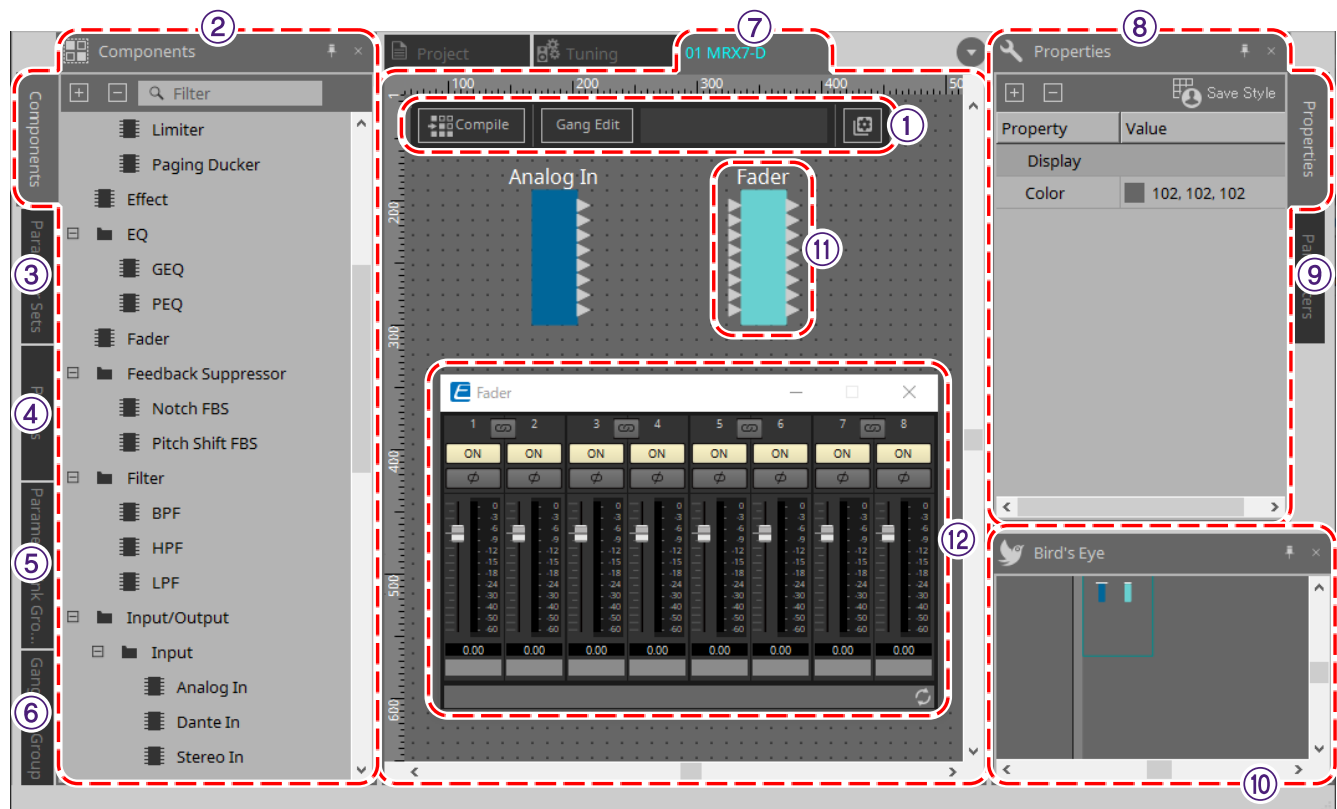

### ① Tool buttons

Buttons have been made for the commands frequently used on the MRX7-D ([Tool buttons](#)).

### ② Components Area

A list of the components is displayed ([Components Area](#)).

### ③ Parameter Sets Area

Configures the parameter sets and snapshots ([Parameter Sets Area](#)).

### ④ Presets Area

Configures presets ([Presets Area](#)).

Presets can be recalled from the main unit's front panel.

### ⑤ Parameter Link Group Area

Creates a parameter link group to link multiple parameters for Level-type or for ON/OFF-type ([Parameter Link Group Area](#)).

### ⑥ Gang Edit Group Area

Creates a gang edit group that links multiple components ([Gang Edit Group Area](#)).

### ⑦ Design Sheet

This is a sheet for placing and connecting components ([Design Sheet](#)).

### ⑧ Properties Area

Changes the settings of the selected component, port, or wire ([Properties Area](#)).

### ⑨ Parameters Area

Displays a list of the components and parameters already placed on the design sheet ([Parameters Area](#)).

### ⑩ Bird's Eye View

Displays a full view of the sheet.

⑪ **Components**

Various signal processing modules such as equalizers and compressors are called "components."

⑫ **Component Editor**

Parameters are set or configured in the Component Editor.

## 14.4. Basic Use

Refer to the [Basic Use](#) of the DME7.

## 14.5. Tool Buttons

These are shortcut buttons for commands that are used frequently on the MRX7-D.

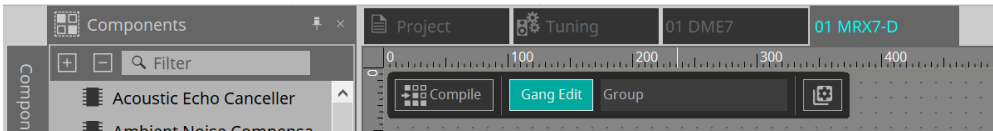

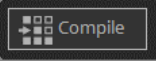
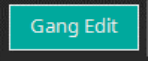
Button	Command	Overview
	[Compile]	Analyzes whether there are any problems with component placement or wiring.
	[Gang Edit]	Turns the Active button in the Gang Edit Group area on or off. When turned on, the name of the currently selected gang edit group is displayed to the right of the button.



Button	Command	Overview
	[Tools]	<p><b>[Remote Control Setup List]</b> Register the parameters to be controlled from the remote controller.</p> <p><b>[SD Card File Manager]</b> Registers files to be played using the SD Card component.</p> <p><b>[Scheduler]</b> Presets can be switched at predetermined dates and times, allowing for songs and sound effects stored on an SD memory card to be played back.</p> <p><b>[GPI]</b> By using the GPI I/Os, the MRX7-D series can be remote controlled from a custom made controller or external device.</p> <p><b>[External Events]</b> Sets the commands output by the MRX7-D.</p> <p><b>[MCP1]</b> Opens the MCP1 editor that was placed on the Project sheet.</p> <p><b>[Install Speech Privacy File]</b> Installs the files related to the Speech Privacy component.</p> <p><b>[Peak Hold]</b> If a check is placed next to ON, the maximum value will be maintained in the meter of the placed component. When Reset is selected, the maximum value retention is reset.</p> <p><b>[Protect User Defined Block]</b> Opens the "Protect User Defined Block" dialog box. Refer to the DME7 "<a href="#">Protect User Defined Block.</a>"</p>

## 14.6. Components Area

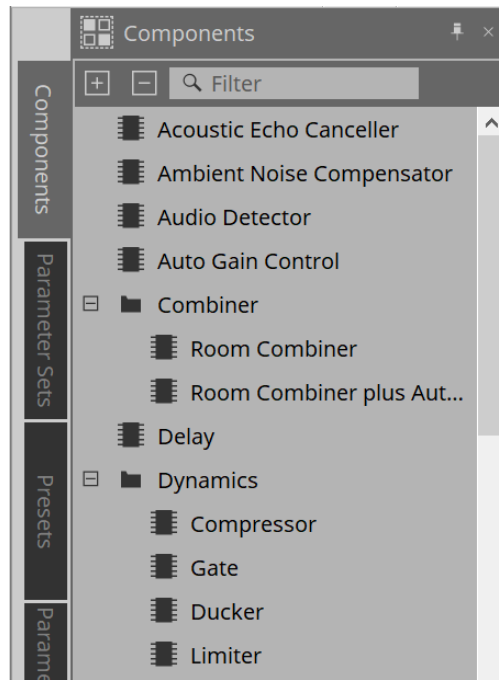

A detailed description of the components can be found at "[ProVisionaire Design DME7 Component Guide.](#)" For components specific to the MRX7-D, please refer to the component editor.

## 14.7. Design Sheet

Refer to the DME7 [Design Sheet](#).

## 14.8. Non-Audio Components

Refer to the DME7 [Non-Audio/Non-Control Components](#).

## 14.9. Parameter Sets Area

A collection of parameters being stored/recalled in a snapshot is called a parameter set. By storing a snapshot, the current values of parameter set members are saved. A single parameter set can store 10 snapshot patterns.

A single parameter can be registered to multiple parameter sets.

Snapshots can be controlled using an external controller by assigning them to the Remote Control Setup List.

Note that snapshots cannot be recalled from the front panel of the main unit (only presets can be recalled). In the Presets area, click on [Recall Settings] to register the snapshot to a preset.

The following methods are available for registering to a parameter set.

Registration Source	Registration Method
Design Sheet	While holding the < Ctrl > key down, drag & drop the component into the Parameter Set name.
	Right-click on the component and select the parameter set to be registered using [Add to Parameter Set].
Component Editor	While holding the < Ctrl > key down, drag & drop the parameter into the Parameter Set name.
Link Control Editor	While holding the < Ctrl > key down, drag & drop the Link Control into the Parameter Set name.
Parameters Area*1	Drag & drop a component or parameter into the Parameter Set name.
	Right-click on the component or parameter and select the parameter set to be registered using [Add to Parameter Set].
Parameter Sets Area	After selecting the parameter set to register, click the [Add Device] button to register all components placed at that point in time.

\*1. Multiple components and parameters can be registered to a parameter set simultaneously by pressing < Shift > and < Ctrl > together.

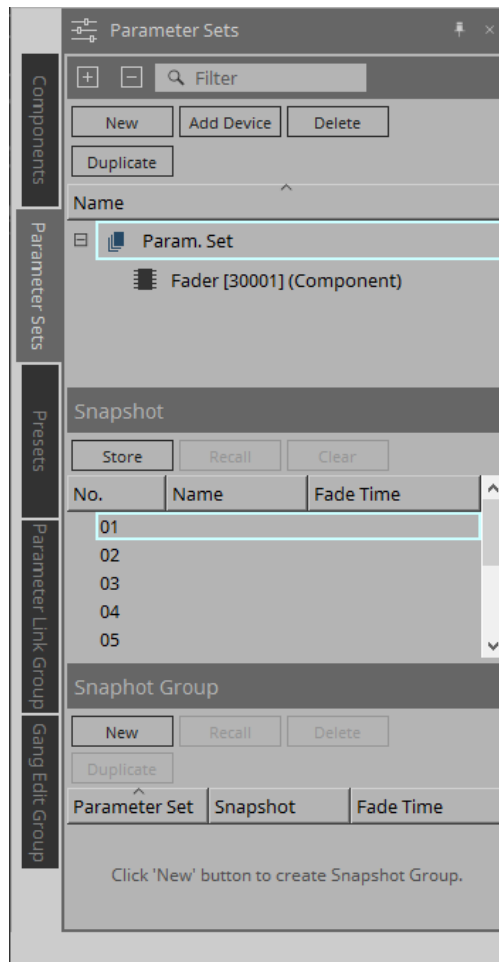

For explanations of Parameter Sets and Snapshots, refer to the DME7 [Parameter Sets Area](#).

### 14.9.1. Snapshot Group

Multiple snapshots can be registered in a single group and recalled all at once. Snapshot groups can be controlled using an external controller by assigning them to the Remote Control Setup List.

Note that snapshot groups cannot be recalled from the front panel of the main unit (only presets can be recalled).

In the Presets area, click on [Recall Settings] to register the snapshot group to a preset.

## 14.9.2. Steps to create a snapshot group

1. Click the [New] button to create a group.

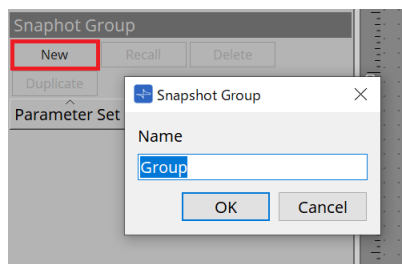

2. Assign snapshots to a Group by using drag & drop.

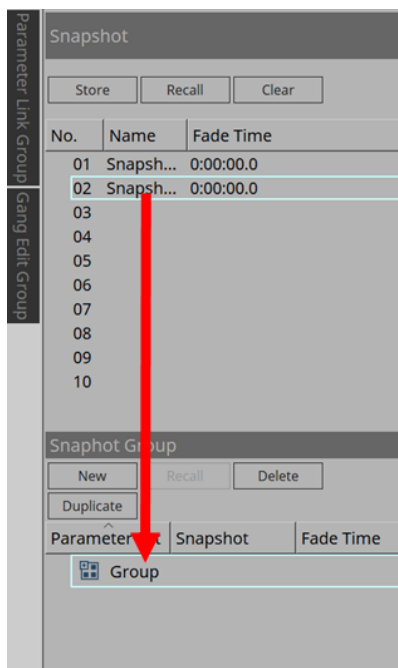

Unstored snapshots can also be assigned.

3. **Rearrange the order of the snapshots as needed.**

Snapshots registered in a Group are recalled in order from the top.

By right-clicking a snapshot, the context menu will be displayed, which allows you to rearrange the order of the snapshots.

Menu	Details
Delete	Deletes the selected snapshot.
Up	Moves the selected snapshot up one level.
Down	Moves the selected snapshot down one level.

If you want to delete a Group or snapshot, select the Group or snapshot and click the [Delete] button. You can also delete by using the computer's Delete key, or selecting [Delete] from the context menu.

## 14.10. Presets Area

Snapshots and snapshot groups cannot be recalled directly from the front panel of the main unit.

Presets can be recalled from the front panel of the main unit.

Register snapshots and snapshot groups to presets.

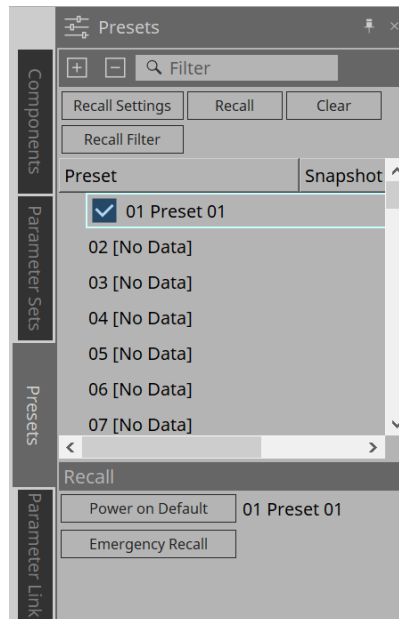

- **Snapshot**  
The snapshots associated with the preset will be displayed in the [Recall Settings] dialog.
- **Enable Scheduler**  
When this is on and the preset is recalled, the scheduler function will be enabled.  
Click the icon to turn this on/off.



When the scheduler function is disabled, the [SCHEDULER] indicator on the main unit will flash rapidly when an event is occurring.

- **Filter**  
In the Recall Filter dialog, if even one part has been set that will not be recalled, a **P** will be displayed.

## 14.10.1. Procedure

1. Select a preset.
2. Click the [Recall Settings] button.

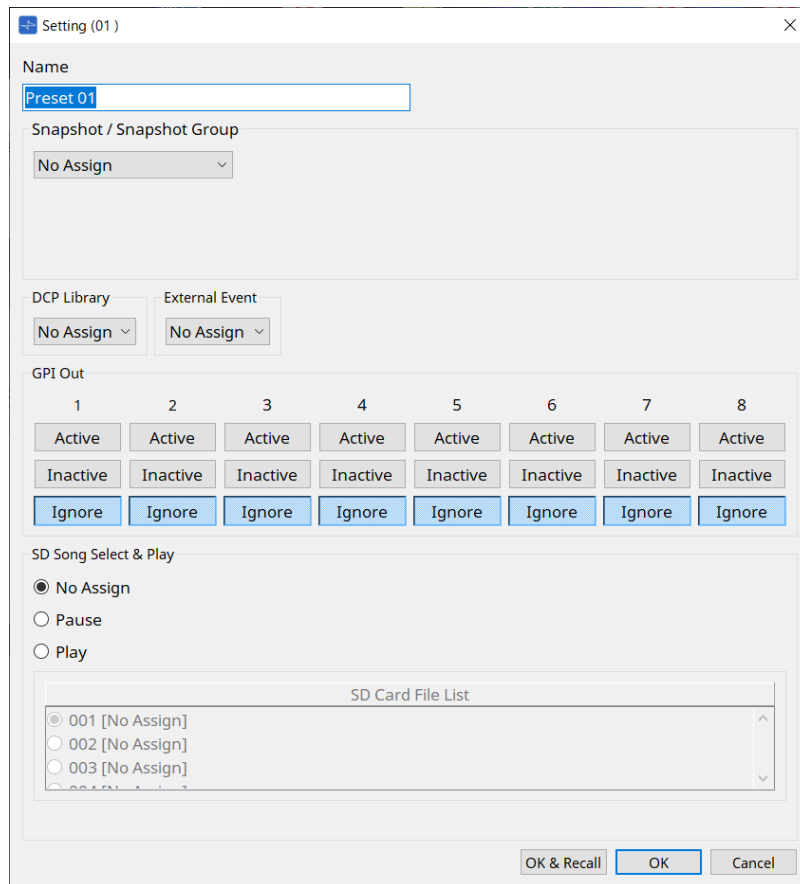

3. In the Recall Settings dialog, **select the Snapshot or Snapshot Group Recall to be assigned to the preset in Snapshot/Snapshot Group.**

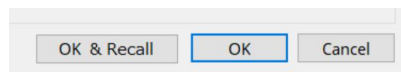

- **[OK & Recall] Button**  
Confirms the current settings, performs a Recall, and closes the dialog.
- **[OK] Button**  
Confirms the settings and closes the dialog.
- **[Cancel] Button**  
Discards the changes and closes the dialog.

For GPI Out and SD Song Select & Play, refer to the DME7 [Recall Settings dialog](#).

For an explanation of Recall, refer to the DME7 [Parameter Sets Area](#).

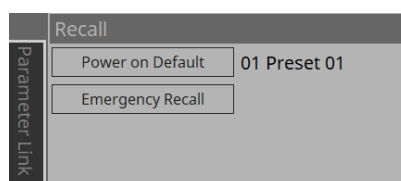

## 14.11. Parameter Link Group Area

Creates a parameter link group to link multiple parameters for Level-type or for ON/OFF-type.

A single parameter can be registered in multiple parameter link groups. The created parameter link group can be used in Snapshot, Scheduler, GPI, DCP, MCP1, or the Remote Control Setup List. Level-type and ON/OFF-type cannot be mixed in a single parameter link group. Up to 64 parameter link groups can be created.

The following methods are available for registering to a parameter link group.

### [Parameter]

Registration Source	Registration Method
Component Editor	While holding the < Ctrl > key down, drag & drop the parameter into the green area of the Settings dialog.
	Right-click the parameter and select the parameter link group to register in [Add to Parameter Link Group].
Parameters Area*1	Drag & drop the parameter into the green area of the Settings dialog.
	Right-click the parameter and select the parameter link group to register in [Add to Parameter Link Group].

\*1. Multiple parameters can be registered to a parameter link group simultaneously by pressing < Shift > and < Ctrl > together.



Pressing any letter key while selecting a parameter link group or other item in the Parameter Link Group area will select the parameter link group or other item with the matching first letter.

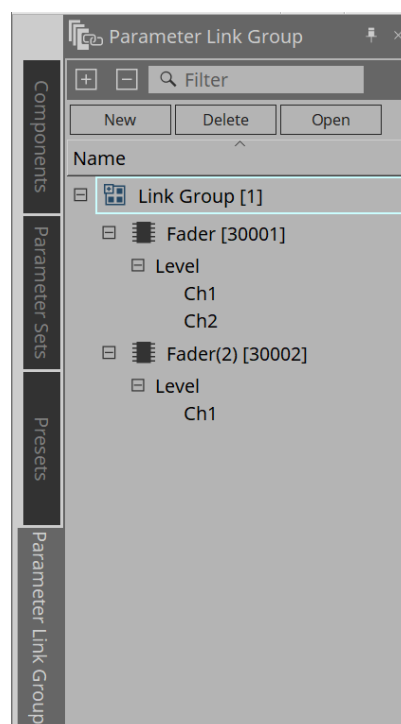

- **[New] Button**

Creates a parameter link group.

- **[Delete] Button**

Deletes the selected parameter link group or parameter.



- **[Open] Button**

Displays the Link Control editor for the selected parameter link group.

### 14.11.1. Link Control Editor

There is a link control for each parameter link group. When a link control is changed, the parameters registered in the parameter link group are also changed at the same time.

Even if the parameters registered in the parameter link group are changed, the link control parameters do not change.

Link control can be assigned to GPI/DCP/Remote Control Setup List/Parameter Link Group/MCP1.

The name of the parameter link group is displayed in the title bar.

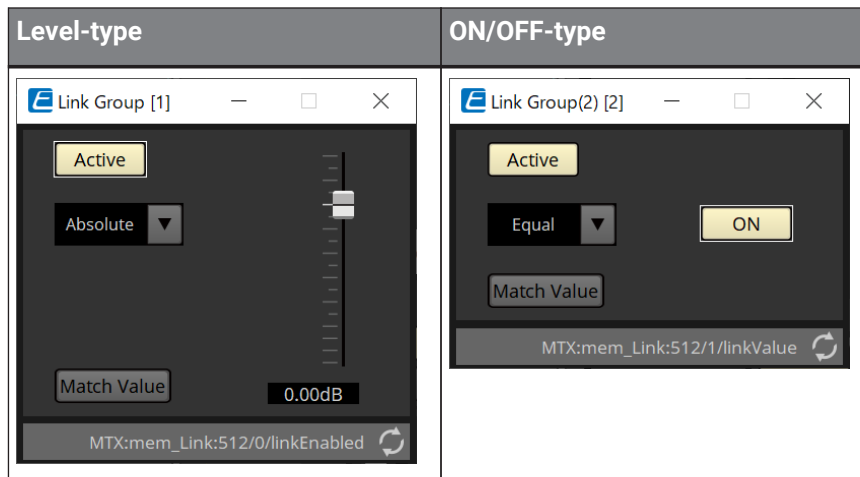

- **Fader (level-type only)**

Sets values for level-type parameters.

- **[ON] Button (ON/OFF-type only)**

Sets values for on/off-type parameters.

- **[Match Values] Button**

If [Absolute] or [Equal] is selected in the combo box, the value of the registered parameter will be the same as the value of the link control.

- **[Active] Button**

If this is on, the parameter link group is enabled. Turn this off if you want to temporarily disable the link.

- **Combo Box**

Set how the level-type and ON/OFF-type settings are applied.

[Absolute]/[Equal]	Sets the value of the registered parameter to the same value as the link control.
[Relative]/[Opposite]	When you operate the link control, the registered parameters will move while maintaining their relative positions.

## 14.12. Gang Edit Group Area

Creates a gang edit group that links multiple components.

Parameters for components of the same type within a group can be changed at the same time. Because this can be done even while online, you can use it to make final adjustments to the Speaker Processor (or others) while listening to the sound at the actual location.

When you open the component editor for one of the components you want to change, it becomes a link control and you can configure other linked components.

Up to 64 gang edit groups can be created.

The following methods are available to register to the Gang Edit Group.

Registration Source	Registration Method
Design Sheet	While holding the < Ctrl > key down, drag & drop the component into the gang edit group name.
	Right-click on the component and select the gang edit group to be registered using [Add to Gang Edit Group].
Parameters Area*1	Drag & drop the component into the gang edit group name. Right-click on the component and select the gang edit group to be registered using [Add to Gang Edit Group].

\*1. Multiple components can be registered to a gang edit group simultaneously by pressing < Shift > and < Ctrl > together.

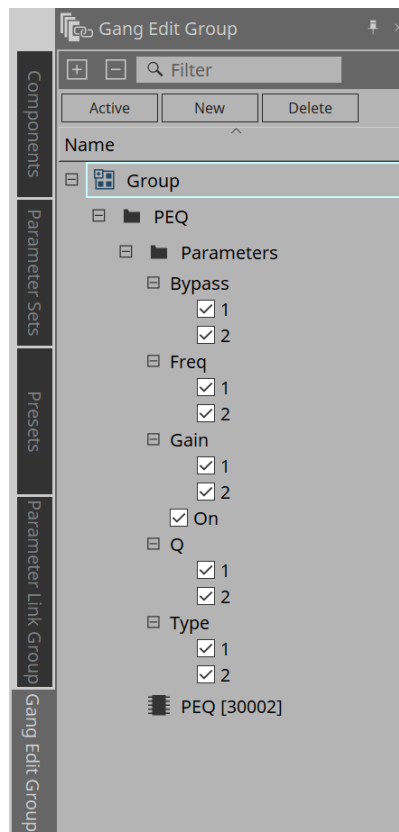

- **[Active] Button**

Enables/disables the gang edit group function. Applies to the currently selected group.

- **[New] Button**  
Creates a gang edit group.
- **[Delete] Button**  
Deletes the selected gang edit group or component.
- **[Parameters]**  
Put a check in the checkbox for the parameter to be linked.

### 14.12.1. Procedure

1. **Click the [New] button to create a group.**
2. **While holding the < Ctrl > key down, drag & drop the component on the sheet into the group name.**  
Or drag & drop the component from the Parameters area.  
Linking only works with components of the same type, but multiple types of components can be registered.
3. **Uncheck the parameters you do not want to link.**
4. **Turn the [Active] button or the [Gang Edit] button in the toolbar ON.**
5. **Double-click a component on any sheet registered in the gang edit group.**  
The component editor will be displayed.
6. **Change the parameters in the component editor.**  
The parameters for components of the same type that belong to the gang edit group will be changed in tandem.
7. **If the [Active] button or the [Gang Edit] button in the toolbar are turned OFF, linking will be disabled.**

## 14.13. Properties Area

Changes the settings of the currently selected component, port, or wire.

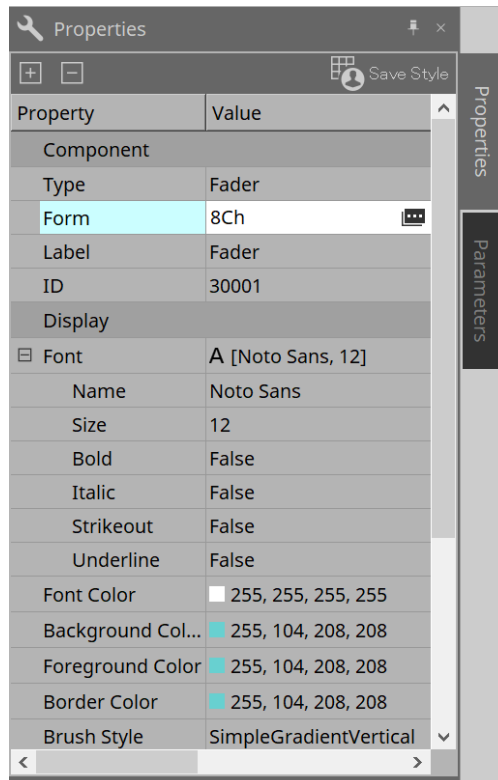

- **Component**

Click the  that is displayed when you click the "Form" value. A dialog is displayed that allows you to change the number of channels for the component.

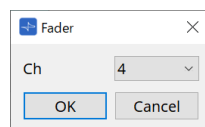

- **Port**

Click the  that is displayed when you click the "Label" value. A dialog is displayed that allows you to edit the labels of all the component ports at once.

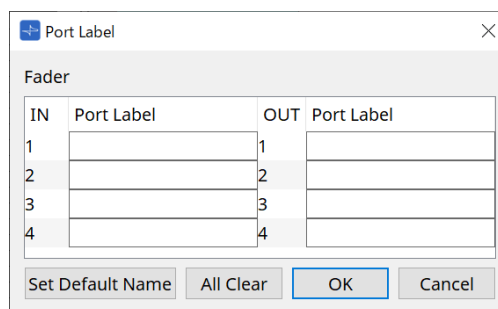

For details, refer to [Port Label dialog](#).

## 14.14. Parameters Area

Displays information about the component currently selected on the design sheet.

The parameters of the component currently selected in the upper area are listed in the lower area.

From this area, you can assign components and parameters to parameter sets, remote control setup lists, GPI dialogs, DCP components, and the MCP1 editor. For assignment methods, refer to the explanation for each screen.

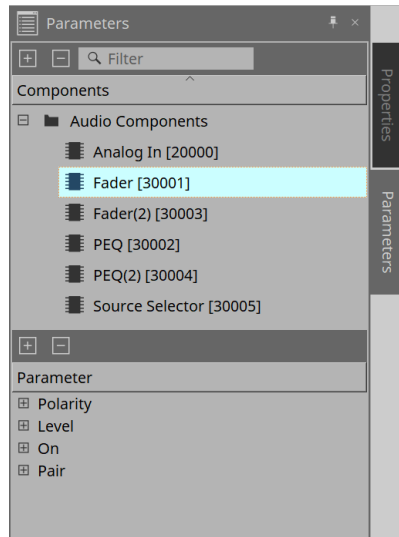

## 14.15. Context Menu

Refer to the DME7 [Context Menu](#).

## 14.16. Dialog

### 14.16.1. Compile Dialog

Click the tool button [Compile] on the device sheet to open this dialog.

Analyzes whether there are any problems with the placement or wiring of the MRX7-D components. It can also check resource consumption, etc.

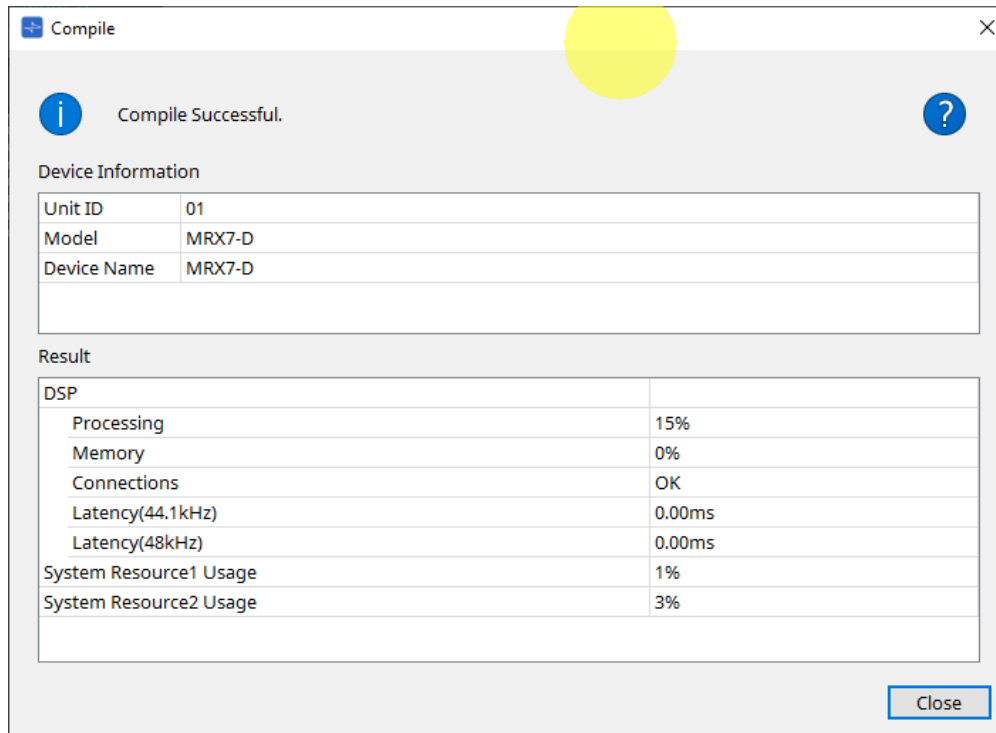

- **i /Message**  
Displays whether the compile action was successful or failed. If it was successful, the message "Completed normally. " is displayed. If it failed, a message saying "Compile failed" is displayed.
- **? Button**  
Click to display the method for resolving the problem.
- **[Result]**  
Displays the compiled results. The MRX-7D can go online only when the compile has succeeded. For each item, check the Information that opens when you click on ?.

## 14.16.2. Remote Control Setup List Dialog

Click [Remote Control Setup List] from the [Tools] button in the device sheet to open this dialog.

The MRX7-D can be controlled from an external device using the Dante [PRIMARY]/[SECONDARY] terminal or the [RS-232C] terminal.

To control or monitor from an external device, parameters, meters, snapshots, and snapshot groups must be registered in the Remote Control Setup List.



Configure the external device according to the "MTX3 MTX5-D MRX7-D XMV Series EXi8 EXo8 Remote Control Protocol Specifications."

### • Remote Setup Tab

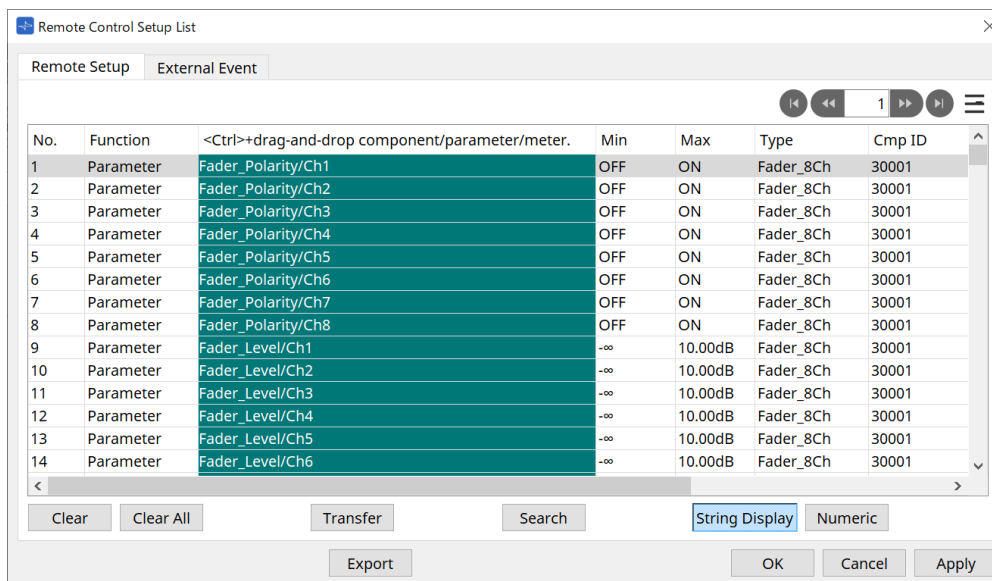

Two methods are available for registering to the list.

Registration Source	Registration Method
Design Sheet	While holding the < Ctrl > key down, drag & drop the component into the list.
	Right-click the component and select [Add to Remote Control List].
Component Editor/ Parameter Setting Window	[Parameters] While holding the < Ctrl > key down, drag & drop the parameter into the list. Right-click the parameter and select [Add to Remote Control List].
	[Components] Right-click a location outside the parameter and select [Add to Remote Control List].
Parameters Area*1	Drag & drop components or parameters into the list. Right-click a component or parameter and select [Add to Remote Control List].
Parameter Sets Area	Drag & drop snapshots into the list. Drag & drop snapshot groups into the list.

Registration Source	Registration Method
Parameter Link Group Editor	While holding the < Ctrl > key down, drag & drop LINK Control into the green area.

\*1. Multiple components and parameters can be registered to the list simultaneously by pressing < Shift > and < Ctrl > together.

- **[Function]**  
Displays the types of items registered in the list.
- **[< Ctrl >+drag-and-drop component/parameter/meter.]**  
Displays the items registered in the list.
- **[Type]**  
Displays the type of component that has parameters registered in the list.
- **[Cmp ID]**  
Displays the ID of a component that has parameters registered in the list.
- **[MIN]/[MAX]**  
Displays the upper and lower limits and selection range for the parameters registered in the list. In the case of Level-type parameters for which a Min/Max value can be configured, clicking this will open a dialog box where you can specify the range.
- **Transfer Button**  
Starts the [File Transfer application](#), which is used to send files to ProVisionaire Touch.

For other functions, refer to the DME7 [Remote Control Setup List dialog](#).

#### • External Event Tab

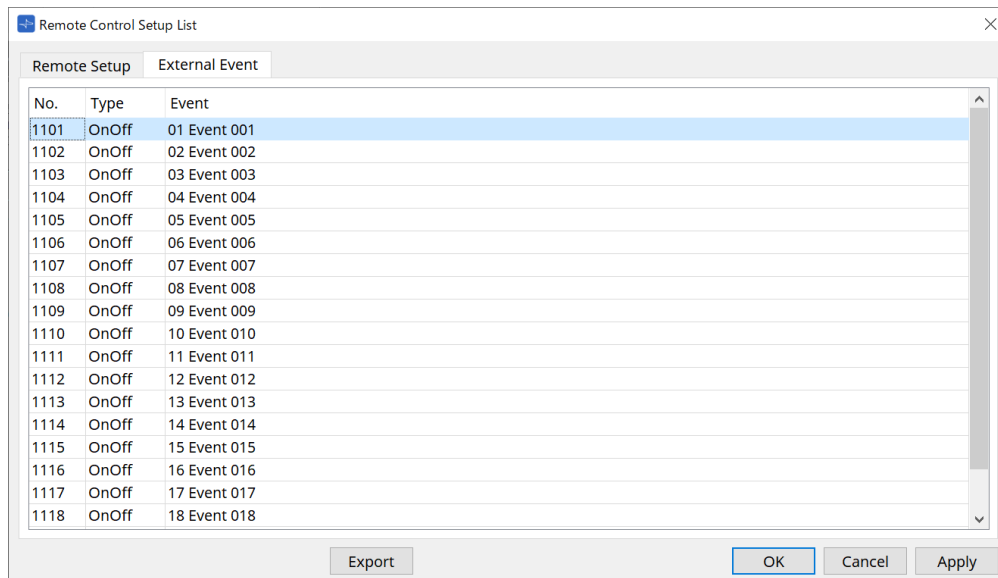

External Events are registered under the initial state of the list.

For details about External Events, refer to the MTX5-D/MTX3 [External Events dialog](#).



### 14.16.3. File Transfer Application

Click the Transfer button in the Remote Control Setup List dialog to open this dialog.

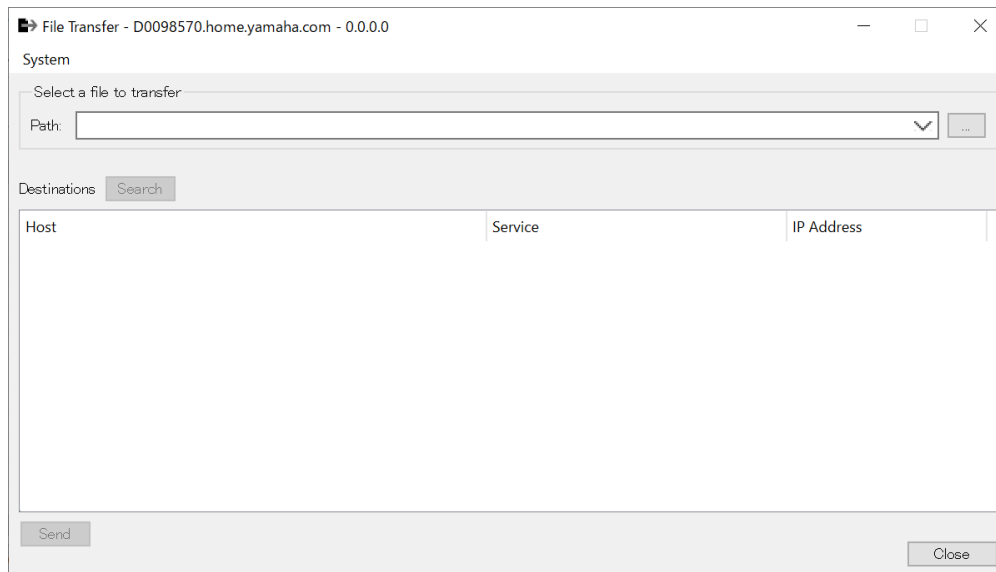

This transfers the exported .rcsl file, PDF file, image file, etc. to an iPad on the same network that has ProVisionaire Touch (V1.2 or later) installed.

Before transferring, start ProVisionaire Touch and confirm that it is displayed on the screen.

If no network adapter has been selected, the [Network Setup] dialog will be displayed for you to select a network adapter.

The file extensions that ProVisionaire Touch can receive are as follows.

.rcsl, .pdf, .jpg, .jpeg, .bmp, .png, .pvt, .ypvt, .ypvk

.pvt, .ypvt, and .ypvk files are saved in the Provisionaire Touch file folder.

.rcsl files can be used by registering the MRX7-D as a device with Provisionaire Touch.

- **System Menu**

Launch the Network Setup dialog from the Network Setup command.

- **Select a file to transfer**

Selects the file to be sent. Clicking the  button on the right side displays the Open File dialog, which allows you to select a file.

- **Destinations**

Select the transfer destination iPad. If you don't see the transfer destination iPad, press the [Search] button to search your network. The [Search] button is enabled when a file to be transferred has been selected.

- **[Send] Button**

Sends the selected file(s) to the selected iPad.

- **[Close] Button**

Closes the File Transfer application.

### 14.16.4. SD Card File Manager Dialog

Click the [Tools] button on the device sheet and then click [SD Card File Manager] to open this dialog. Refer to the DME7 [SD Card File Manager dialog](#).

### 14.16.5. Scheduler Dialog

Click the [Tools] button on the device sheet and then click [Scheduler] to open this dialog. Refer to the MTX5-D/MTX3 [Scheduler dialog](#).

### 14.16.6. GPI Dialog

Click the [Tools] button on the device sheet and then click [GPI] to open this dialog. Refer to the DME7 [GPI dialog](#).



The MRX7-D does not have GPI settings on the control layer.  
The MRX7-D does not have a Control Type: Direct Parameter Value setting.

The following methods are available for registering parameters, snapshots, snapshot groups, and presets.

Registration Source	Registration Method
Parameter Sets Area	Drag & drop snapshots and snapshot groups into the green area.
Presets Area	Drag & drop presets into the green area.
Component Editor	While holding the < Ctrl > key down, drag & drop the parameter into the green area.
Parameters Area	Drag & drop the parameter into the green area.
Parameter Link Group Editor	While holding the < Ctrl > key down, drag & drop LINK Control into the green area.

### 14.16.7. External Events Dialog

Click the [Tools] button on the device sheet and then click [External Events] to open this dialog.

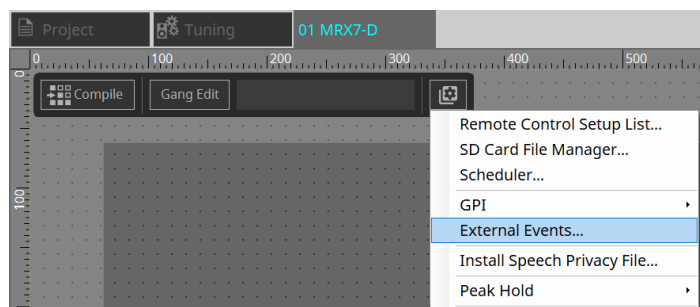

Refer to the MTX5-D/MTX3 [External Events dialog](#).

### 14.16.8. Install Speech Privacy File Dialog

Click the [Tools] button on the device sheet and then click [Install Speech Privacy File] to open this dialog. Installs the files related to the Speech Privacy component to the MRX7-D.

Once the installation is complete, the MRX7-D will restart.

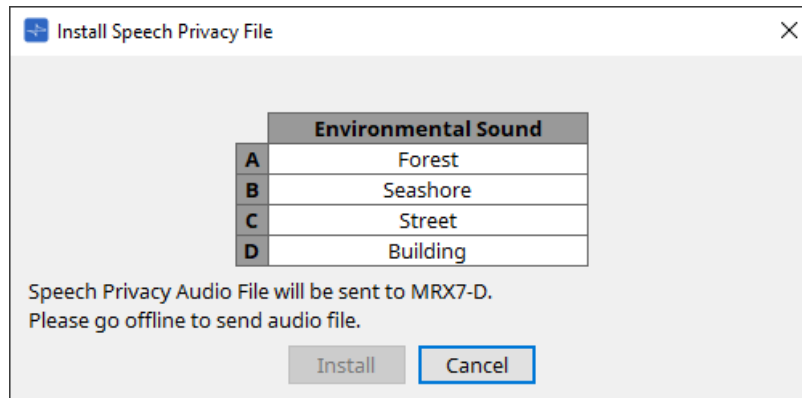

- **[Install] Button**  
Starts the installation of files to the MRX7-D.
- **[Cancel] Button**  
Closes the dialog without installing any files.

## 14.17. Component Editor

Drag & drop parameters into the Component Editor while holding down the < Ctrl > key on the keyboard to assign them to the ProVisionaire Control page.

A detailed description of the components not listed below can be found at "[ProVisionaire Design DME7 Component Guide](#)."

### 14.17.1. Acoustic Echo Canceller Component Editor

Acoustic Echo Canceller (AEC) is a function that eliminates echoes caused by speaker reflections and wall reflections (acoustic echoes), as well as constant noise from air conditioners, etc., all of which are problems during teleconferences. By delivering clear audio that eliminates echoes and noise to the other party, smooth conversations can be achieved during the teleconference.

Note that to eliminate the acoustic echo generated on the other party's side, a system with an acoustic echo canceller function must also be installed at their end.

Each MRX7-D can be equipped with AECs for up to 8 channels.

The following delay amount is added to the signal path where the AEC component has been placed.

**When the word clock is 44.1kHz:** 26.17msec

**When the word clock is 48kHz:** 24.02msec

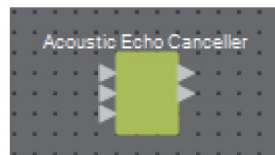

The AEC inputs are as follows, from top to bottom.

- **MicIn 1:** Input from microphone
- **MicIn 2:** Input from microphone
- **Reference:** Input of a signal that you do not want to send to a remote location (a signal to be considered an echo and removed) (e.g., Codec In)



MicIn 1 and MicIn 2 should be inputs from microphones in the same conference room.

#### ■ AEC Editor

This configures the AEC-related settings. The left side of the screen is for settings related to the microphone connected to MicIn 1, and the right side of the screen is for settings for the microphone connected to MicIn 2.

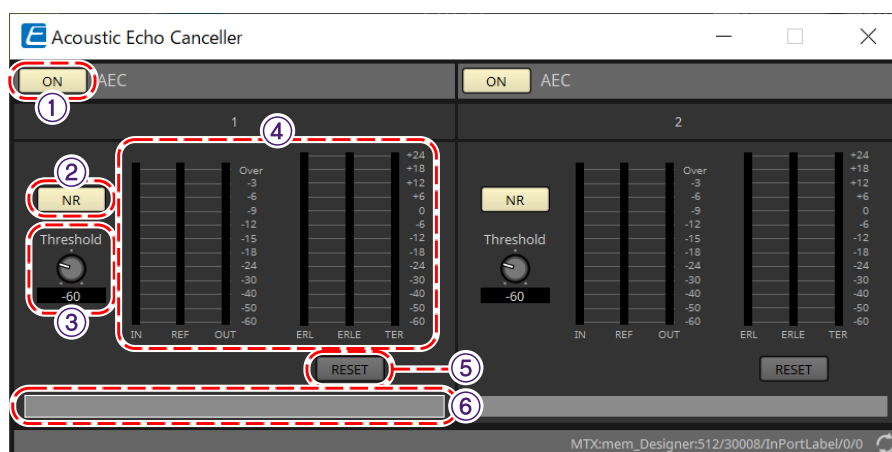

**① AEC [ON] Button**

Enables or disables the AEC function.

**② [NR] Button**

Turns the noise reduction function on/off, to eliminate constant noise from nearby projectors, air conditioners, etc. It is recommended that this normally be turned on.

**③ [THRESHOLD] Knob**

When using noise reduction, any noise that exceeds the Threshold level is attenuated to the level set as the Threshold.

**④ Level Meter**

Displays the information related to input/output and acoustic echo.

**• [IN] Level Meter**

Displays the input level from the microphone.

**• [REF] Level Meter**

Displays the input level from Reference.

**• [OUT] Level Meter**

Displays the output level from the AEC.

**• [ERL] Level Meter**

Displays the ratio between the Reference input and the Amount of echo included in the microphone input as estimated by the AEC.

A good installation environment is one in which ERL (Echo Return Loss) is between 0 dB and -16 dB. If it is greater than 0 dB, the input level of the microphone may be too high or the microphone and speaker may be too close. If it is lower than -16 dB, the microphone's input level may be too low.

**• [ERLE] Level Meter**

Displays the amount (in dB) of acoustic echo that the AEC has removed from the microphone input as a result of learning. If the echo is removed correctly, a negative value will be displayed.

**• [TER] Level Meter**

Displays the amount (in dB) of acoustic echo ultimately removed.

**⑤ [RESET] Button**

The information learned by AEC is resent when this is clicked.

**⑥ Port Text Box**

Displays the port name. The name can be changed by double-clicking.

## 14.17.2. [Effect] Component Editor

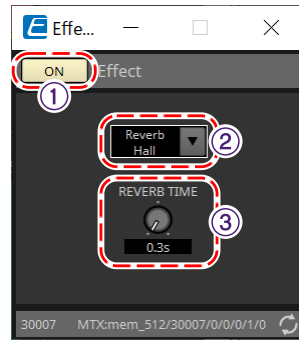

### ① EFFECT [ON] Button

Enables or disables the effect function.

### ② Effect Type List Box

Selects the effect type. There are four types that can be selected.

- **Reverb Hall**  
This is a reverb that simulates a large space such as a concert hall.
- **Reverb Stage**  
This is a reverb that simulates a wide stage.
- **Karaoke Echo**  
This is a microphone echo intended for use in karaoke.
- **Vocal Echo**  
This is an echo that is designed specifically for vocals and is intended for use on stage.

### ③ Effect Parameter Knob

Adjusts one effect parameter. If the effect type is Reverb, this will be [REVERB TIME], and if it is Echo, this will be [DELAY TIME].

### 14.17.3. Analog In Component Editor

Displays settings related to the HA (head amp) for the [INPUT] terminal and the level of the input audio signal.

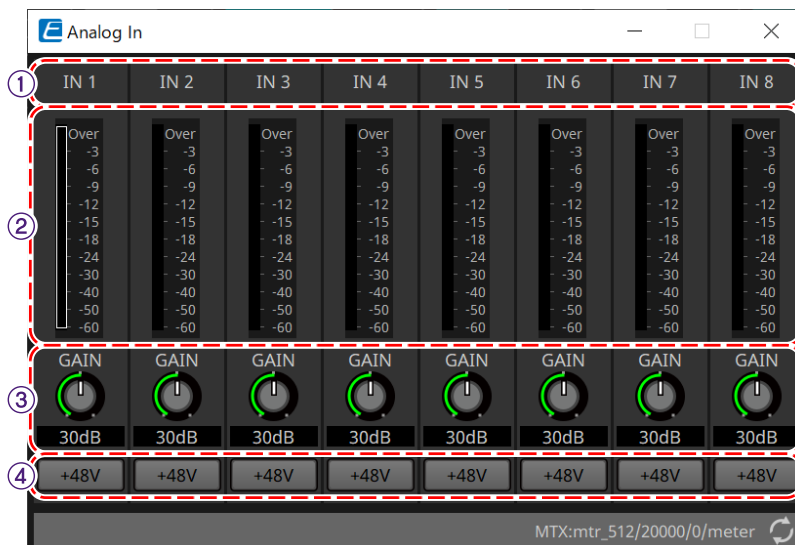

#### ① Channel Index

Displays the analog input terminal number.

#### ② Level Meter

Displays the analog input level.

#### ③ [GAIN] Knob

Adjusts the HA (head amp) analog gain.

#### ④ [+48V] Button

Switches the HA phantom power supply (+48 V) ON and OFF.

#### ! NOTE

If the phantom power supply is not required, turn this button OFF.

If the phantom power supply is turned ON, please note the following to prevent damage or noise to the main device/external devices.

- When connecting a device that is not phantom power compatible to an [INPUT] terminal, turn the button OFF.
  - Do not disconnect cables from the [INPUT] terminal while the power button is still ON.
  - Set the output level to its lowest level when turning the phantom power supply off or on.
- There is no +48 V Active switch. Use settings that match the connected equipment to avoid damage.

### 14.17.4. Slot In Component Editor

Displays the audio signal level being input from the Mini-YGDAI card.

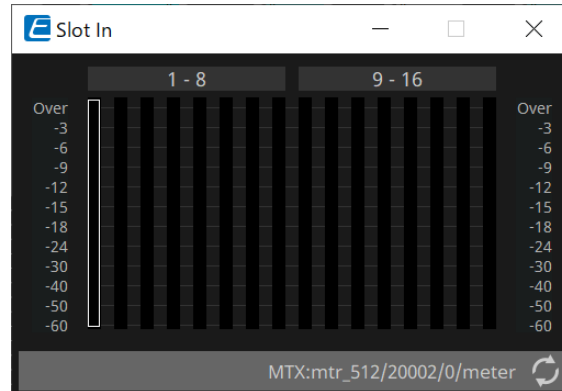



### 14.17.5. Analog Out Component Editor

Displays the settings related to the [OUTPUT] terminal output and the level of the audio signal being output.

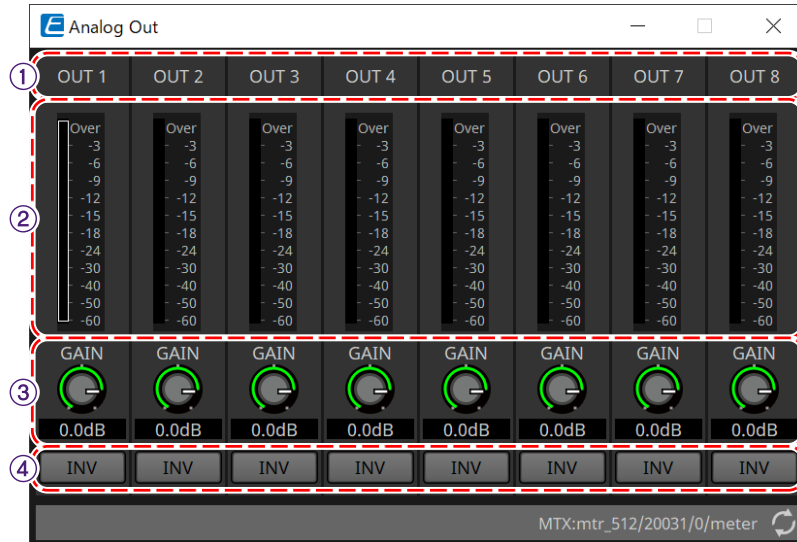

① **Channel Index**

Displays the analog output terminal number.

② **Level Meter**

Displays the analog output level.

③ **[GAIN] Knob**

Adjusts the output gain.

④ **[INV] Button**

Switches the output signal polarity.

## 14.17.6. Slot Out Component Editor

Displays the settings related to the Mini-YGDAI card output and the level of the audio signal being output.

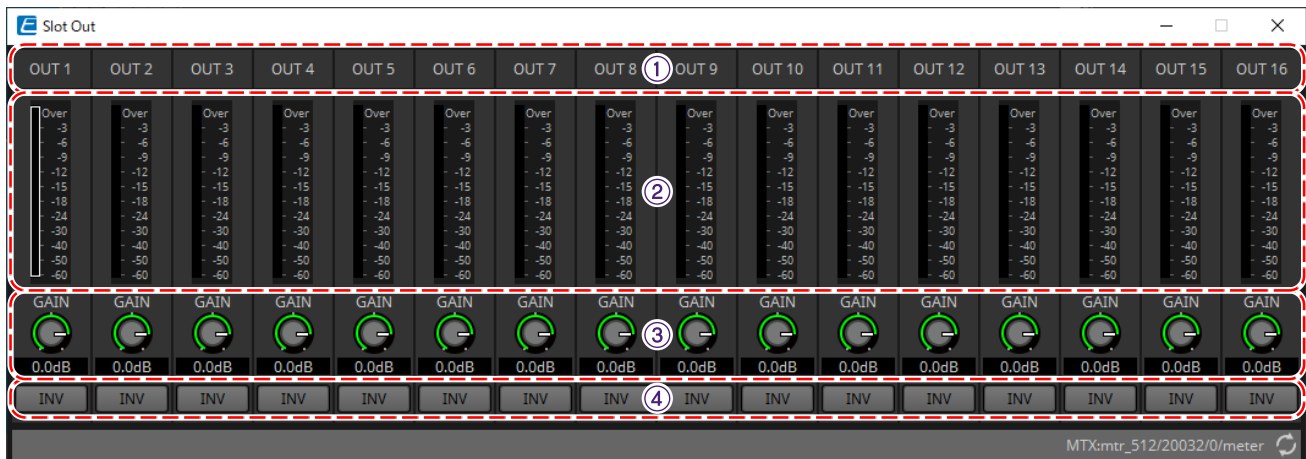

### ① Channel Index

Displays the output terminal number.

### ② Level Meter

Displays the output level.

### ③ [GAIN] Knob

Adjusts the output gain.

### ④ [INV] Button

Switches the output signal polarity.

### 14.17.7. Speech Privacy Component Editor

This function mixes environmental sounds and disturbance sounds to make it difficult for people around you to hear conversations in a particular location.

Only one can be installed for each MRX7-D.

Two mixed signals are output for each system, one without offset and one with offset that offsets the playback point. By alternating the speakers that output each of these, discomfort caused by phase shift in areas where audio overlaps is reduced.

Before putting the MRX7-D online, use the [Install Speech Privacy File dialog](#) that is displayed when you select [Install Speech Privacy File] from the [Tools] button to install the files to the MRX7-D.

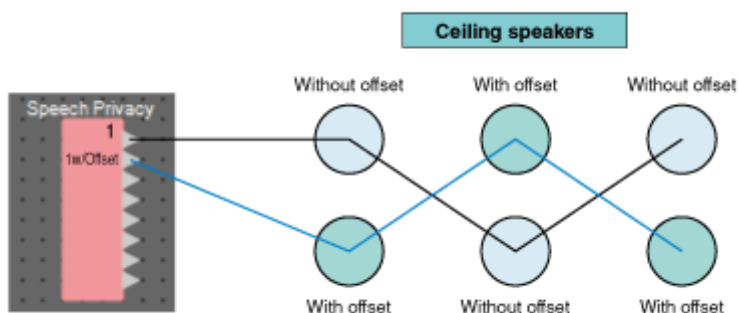

Configure settings related to environmental sounds and disturbance sounds in the Speech Privacy component editor.

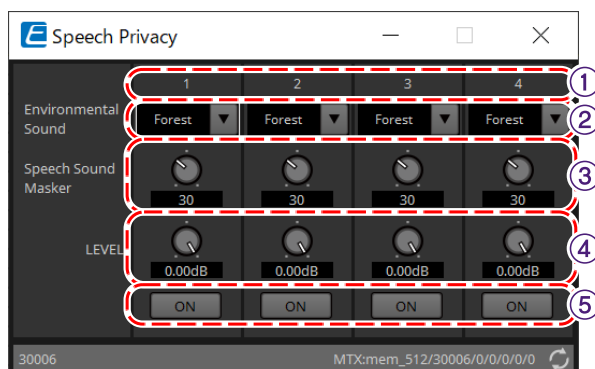

#### ① System Index

Displays the number for the system to be configured.

#### ② [Environmental Sound] List Box

Sets the environmental sound to be used. Select to match the output environment.

- **Forest:** Forest sounds
- **Seashore:** The sound of waves
- **Street:** Street sounds
- **Building:** Air conditioning sounds

#### ③ [Speech Sound Masker] Knob

Sets the percentage of disturbance sound to be included in the output audio. The unit is %.

#### ④ [LEVEL] Knob

Sets the signal level for the mix of environmental sounds and disturbance sounds.

**⑤ [ON] Button**

Mutes or unmutes the mixed signals of each system.

## 14.18. Alert List

Refer to the MTX5-D/MTX3 [Alert List](#).

## 14.19. Flow of Paging Configuration

For the MRX7-D, to use PGM1, first place the Paging component from the Components area on the device sheet. For the setting method, refer to the MTX5-D [Flow of Paging Configuration](#).

# 15. Audio Processors: MTX5-D/MTX3

## 15.1. Overview

The MTX3/MTX5-D is a processor optimized for small- to mid-size installations in stores or banquet halls. For details, please refer to the user's manual for the equipment.

## 15.2. "Project" sheet

This is the sheet on which devices are placed. When placing devices, the Settings screen shown below is displayed.

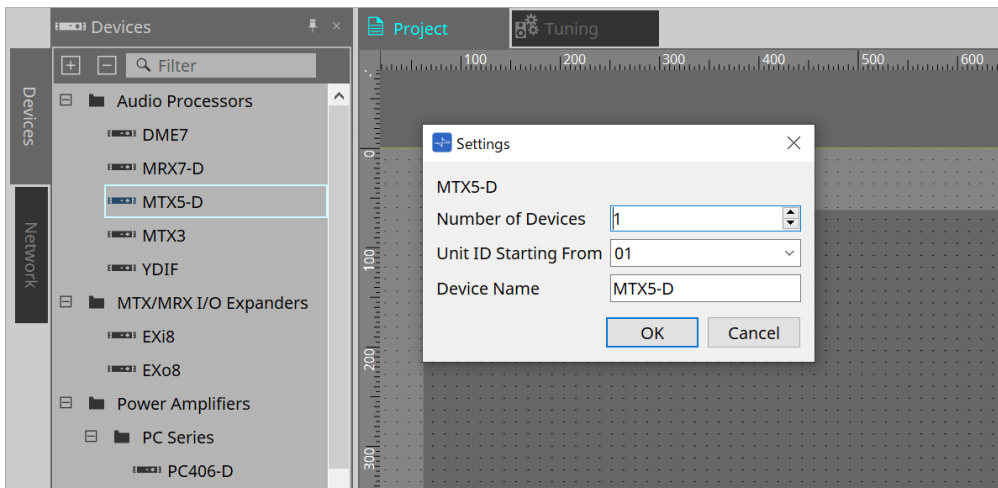

- **Number of Devices**  
Selects the number of MTX units placed on the sheet.
- **Unit ID Starting From**  
You can select the starting number for the device Unit IDs.
- **Device Name**  
The device name can be displayed and edited.

### 15.2.1. "Devices" area

If "YDIF" is added to the project, an example of connecting multiple devices by YDIF terminals is provided. The word clock setting is performed automatically.

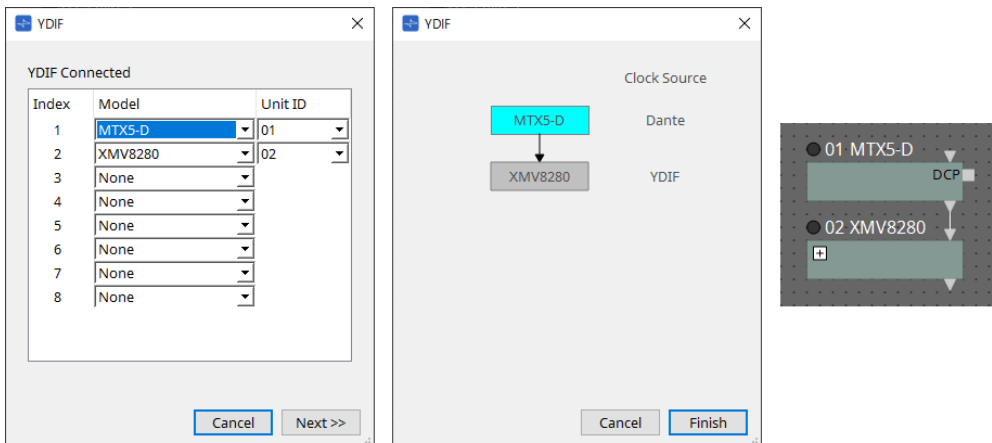

## 15.2.2. "Properties" area

Displays/edits the MTX information.

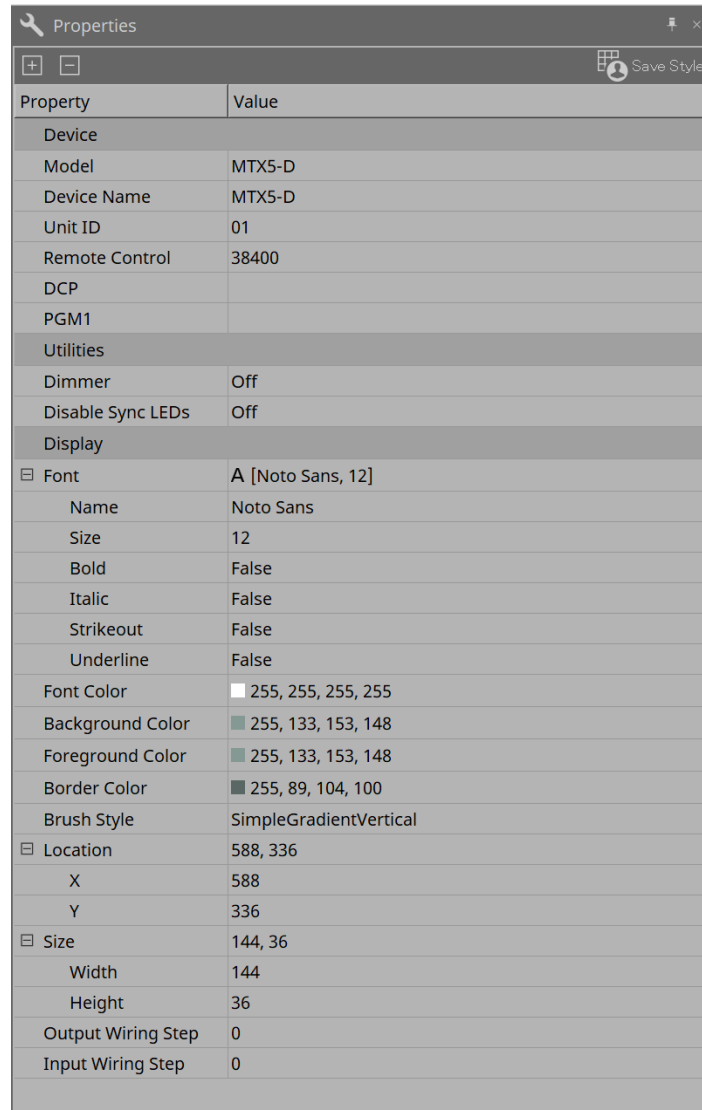

Property	Value
<b>Device</b>	
Model	MTX5-D
Device Name	MTX5-D
Unit ID	01
Remote Control	38400
DCP	
PGM1	
<b>Utilities</b>	
Dimmer	Off
Disable Sync LEDs	Off
<b>Display</b>	
Font	A [Noto Sans, 12]
Name	Noto Sans
Size	12
Bold	False
Italic	False
Strikeout	False
Underline	False
Font Color	255, 255, 255, 255
Background Color	255, 133, 153, 148
Foreground Color	255, 133, 153, 148
Border Color	255, 89, 104, 100
Brush Style	SimpleGradientVertical
Location	588, 336
X	588
Y	336
Size	144, 36
Width	144
Height	36
Output Wiring Step	0
Input Wiring Step	0

### • Remote Control

Here you can check the port numbers for connecting an external controller, or make settings for connecting an external controller to RS-232C.

The [Remote Control] dialog is displayed from the , which is displayed when the property Value field is clicked.

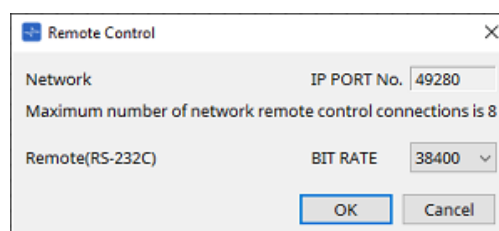

Remote Control

Network IP PORT No. 49280

Maximum number of network remote control connections is 8

Remote(RS-232C) BIT RATE 38400

OK Cancel

#### ◦ [Network IP PORT No.]

This shows the port number of the MTX3's NETWORK connector or the MTX5-D's Dante [PRIMARY]/[SECONDARY] connectors. You can connect up to eight external controllers or wireless DCP to the port.

#### ◦ [Remote(RS-232C) BIT RATE] box

Selects the RS-232C communication speed. You can select "38400" bps or "115200" bps. You can connect one external controller to the RS-232C.

- **[OK] button**  
Saves the settings and closes the dialog box.
- **[Cancel] button**  
Closes the dialog box without saving the changes.

- **DCP**

Select the DCP that has been connected to the DCP port.

The [DCP] dialog is displayed from the , which is displayed when the property Value field is clicked. For details, refer to the ["DCP" chapter](#).

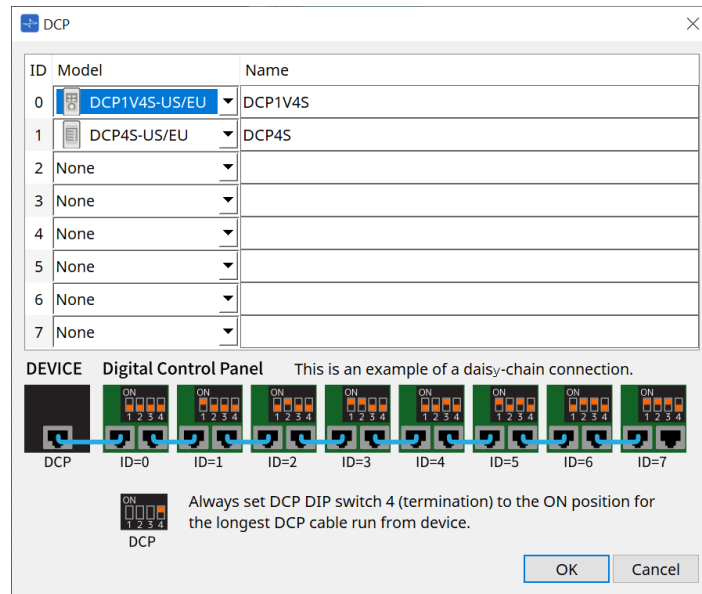

- **PGM1 (MTX5-D only)**

Specify the Unit ID for the PGM1 that is controlling the MTX5-D.

The [PGM1] dialog is displayed from the , which is displayed when the property Value field is clicked. For details, refer to the ["Workflow for paging settings"](#).

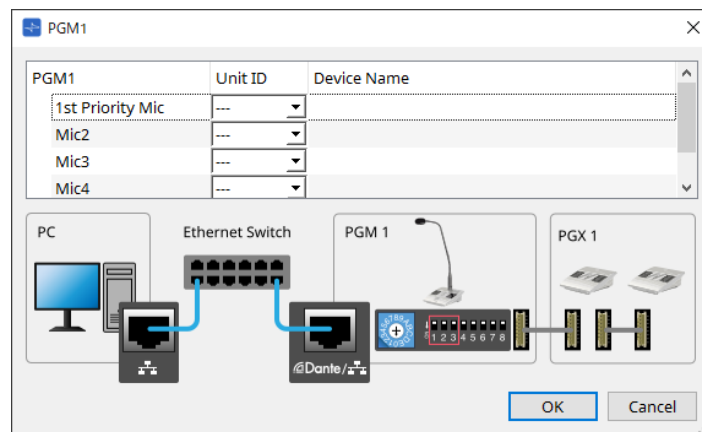

Because the PGM1 settings are stored by the MTX5-D, it is normally not necessary for ProVisionaire Design to discover the PGM1.

When using ProVisionaire Design to update the PGM1 firmware or change the IP address, please install Bonjour Print Service to allow ProVisionaire Design to discover the device.

## 15.3. Device sheet screen configuration

When the MTX device sheet is opened, the "Presets" area and the "Bird's Eye view" will be displayed.

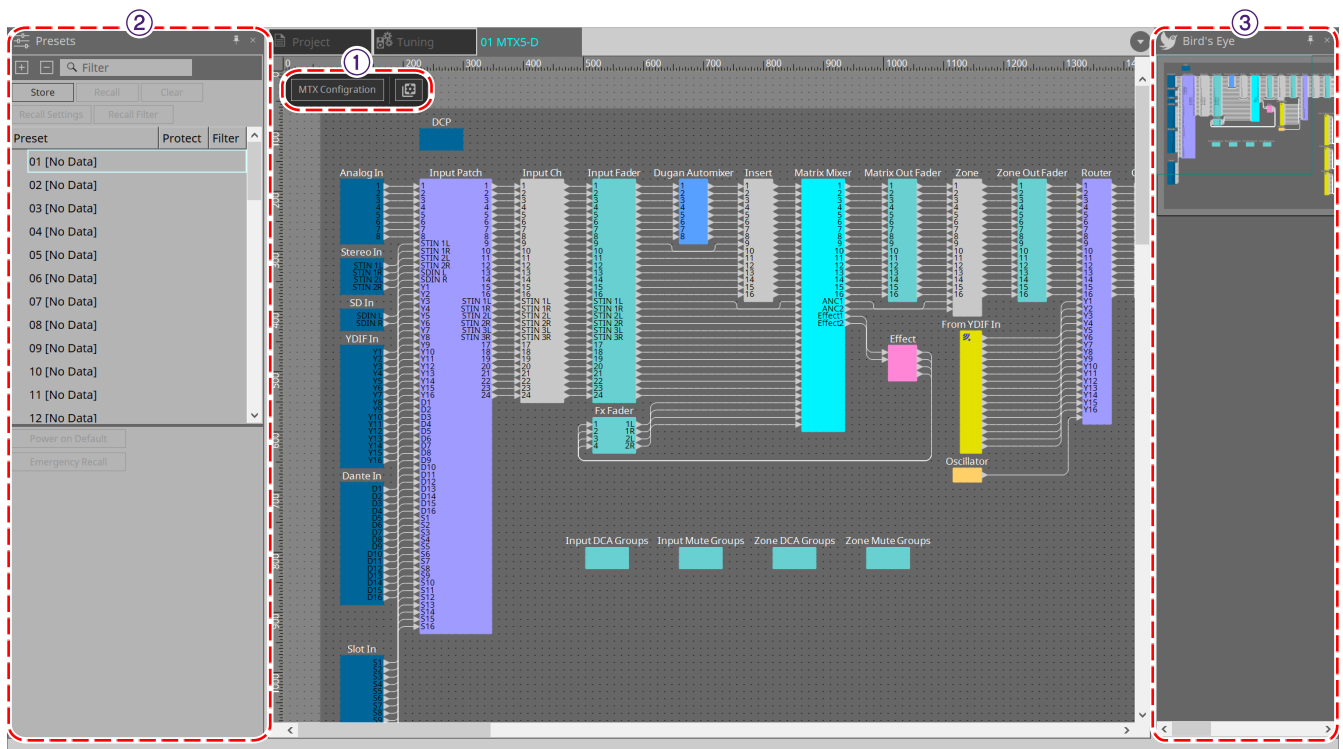

### ① Tool buttons

Frequently-used commands are provided here as buttons.

### ② "Presets" area

Multiple parameter settings can be stored as presets.



### ③ Bird's Eye view

This shows an overview of the sheet.



## 15.4. Tool buttons

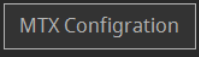

Frequently-used commands are provided here as buttons.

Button	Command	Summary
	<a href="#">MTX Configuration</a>	<p>The MTX I/O settings, such as input port and output channel, matrix bus, etc., are specified for each device. This command cannot be selected on the Project screen.</p>
	Tools	<p><a href="#">[SD Card File Manager]</a> Registers files to be played using the SD Card component.</p> <p><a href="#">[Scheduler]</a> Presets can be switched at predetermined dates and times, allowing for songs and sound effects stored on an SD memory card to be played back.</p> <p><a href="#">[GPI]</a> By using the GPI I/Os, the MTX series can be remote controlled from a custom made controller or external device.</p> <p><a href="#">[External Events]</a> Sets the commands output by the MTX.</p>

## 15.5. "Presets" area

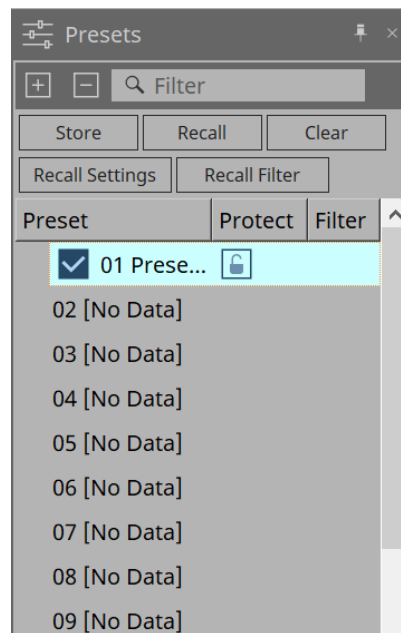
This area can be used to store (save) parameter values as presets. By recalling a preset, the parameters can be deployed as the current value (current parameter). Presets can be recalled using the device's front panel.



- **[Store] button**  
Stores the preset in the selected location.
- **[Recall] button**  
Recalls the selected preset.
- **[Clear] button**  
Clears the selected preset.
- **[Recall settings] button**  
Opens the "Recall Settings" dialog.
- **[Recall Filter] button**  
Opens the "Recall Filter" dialog.
- **Preset list**  
Displays a list of the presets. A maximum of 50 presets can be stored.
  - **Preset**  
Displays the preset number and name.  
When you double click on a stored preset, the name can be edited.  
This will indicate [No Data] for empty presets.
  - **Protect**  
When you click on the  key icon and the icon changes to , protection is applied and it cannot be edited.  
If you click on the icon when protection has been applied, the protection will be canceled.



To recall presets for multiple devices simultaneously, click the  button and set in the "Linked Presets Manager" dialog.

- **Enable Scheduler**

When this is on and the preset is recalled, the scheduler function will be enabled.  
Click the icon to turn this on/off.



When the scheduler function is disabled, the [SCHEDULER] indicator on the main unit will flash rapidly when an event is occurring.

- **Filter**

In the Recall Filter dialog, if even one part has been set that will not be recalled, a **P** will be displayed.

### 15.5.1. Recall

- **Power on Default**

Sets the preset to be recalled when the power supply for the main unit is turned on. Pressing the Set button in the [Power on Default] dialog sets the currently selected preset. When no preset has been set, the device starts in the state it was in when it was previously powered off. To cancel, select Clear in the [Power on Default] dialog.

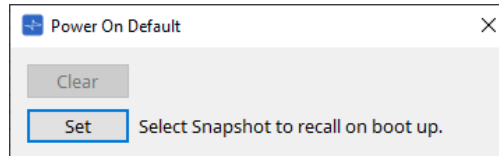

- **Emergency Recall**

Sets the preset to be recalled when the MTX receives an EMG (Emergency) signal from an external device, or when the input to the +24 V compatible [GPI IN] terminal (IN 16) has dropped below 2.5 V. The methods for setting and canceling are the same as Power on Default.

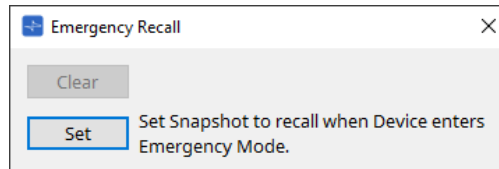

## 15.6. Context menus

### 15.6.1. MTX5-D sheet/MTX3 sheet

When you right-click on a location with no object in the MTX, the following context menu will be displayed.

Menu	Content
[Close All Editor Windows]	Closes all editors.

### 15.6.2. Components/in the MTX/component editor

When you right-click on any location other than the component's operator or component, the following context menu will be displayed (some items may be omitted).

Menu	Content
[Open Component Editor]	Opens the component editor.
[Copy]	Copies the component editor's parameter settings.
[Paste Parameters]	Reflects the component editor's parameter settings that have been copied.
[Select Mini-YGDAL Card]	Only the "Slot In" or "Slot Out" component editors will be displayed. The "Slot" dialog to select a Mini-YGDAL Card opens.
[Sampling Rate Converter]	This will be displayed when you select MY4-AEC or MY8-AE96S in the Slot dialog. The dialog to set the SRC (Sampling Rate Converter) for MY4-AEC or MY8-AE96S opens.

## 15.7. Dialog box

### 15.7.1. "MTX Configuration" dialog box

Click on the [MTX Configuration] tool button in the device sheet to open this dialog. Here you can specify input/output settings, such as MTX input ports, output channels, and matrix buses.



Since these settings are not included in a preset, they cannot be changed via the Preset Recall function.

#### • [INPUT] tab

In this tab, you can make settings related to inputs.

##### ◦ INPUT PORT SETUP

Here you can specify the inputs to the stereo input ports.

STEREO..... The stereo signal will be input without change.

SUM..... The L and R inputs will be summed to a single channel. There will be one input to the input patch.

##### ◦ INPUT CHANNEL SETUP

Here you can make settings for the input channels.

MONO x2..... The input channels will be treated as two monaural channels.

STEREO..... The input channels will be treated as a single stereo pair.

#### • [OUTPUT] tab

In this tab, you can make settings related to outputs.

##### ◦ MATRIX BUS SETUP

Here you can make settings for the matrix buses.

MONO x2..... The input channels will be treated as two monaural channels.

STEREO..... The input channels will be treated as a single stereo pair.

If the MTX system's YDIF mode is Cascade mode, the parameters will be shared in common by all MTX units in the MTX system.

##### ◦ OUTPUT CHANNEL SETUP

Here you can specify the type of output channel speaker processor (1WAYx2 or 2WAY). The settings here affect the Room EQ and Speaker Processor in the "Output CH" component editor.

- **[Advanced Settings] button**  
The “Advanced Settings” dialog box will appear.
- **[OK] button**  
Saves the settings and closes the dialog box.
- **[Cancel] button**  
Discards the settings and closes the dialog box.

### “Advanced Settings” dialog box

Here you can specify the Matrix Mixer component’s pan mode (PAN or Blend). The [MATRIX BUS SETUP] setting can be specified only for STEREO channels.

If you choose [Blend], the right and left channels of the stereo audio will be mixed while preserving the sense of stereo. For example in some old stereo recordings, completely different audio is recorded on the left and right channels; if such audio is played via a stereo background music system, it may produce the impression that different music is playing in different areas. “Blend” is effective in mitigating this difference.

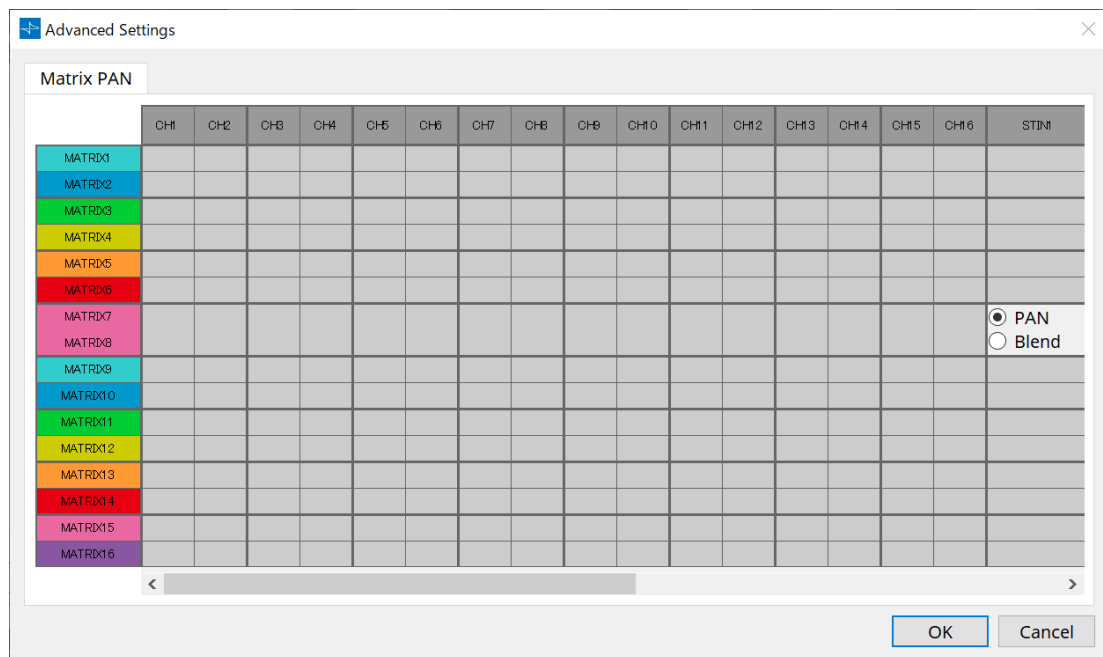

- **[OK] button**  
Saves the settings and closes the dialog box.
- **[Cancel] button**  
Discards the settings and closes the dialog box.

## 15.7.2. "SD Card File Manager" dialog box

Click the [Tools] button on the device sheet and then click [SD Card File Manager] to open this dialog.

Registers files to be played using the SD Card component.

This list is used for file playback via DCP, GPI, etc.

For details, refer to the [DME7 chapter](#).

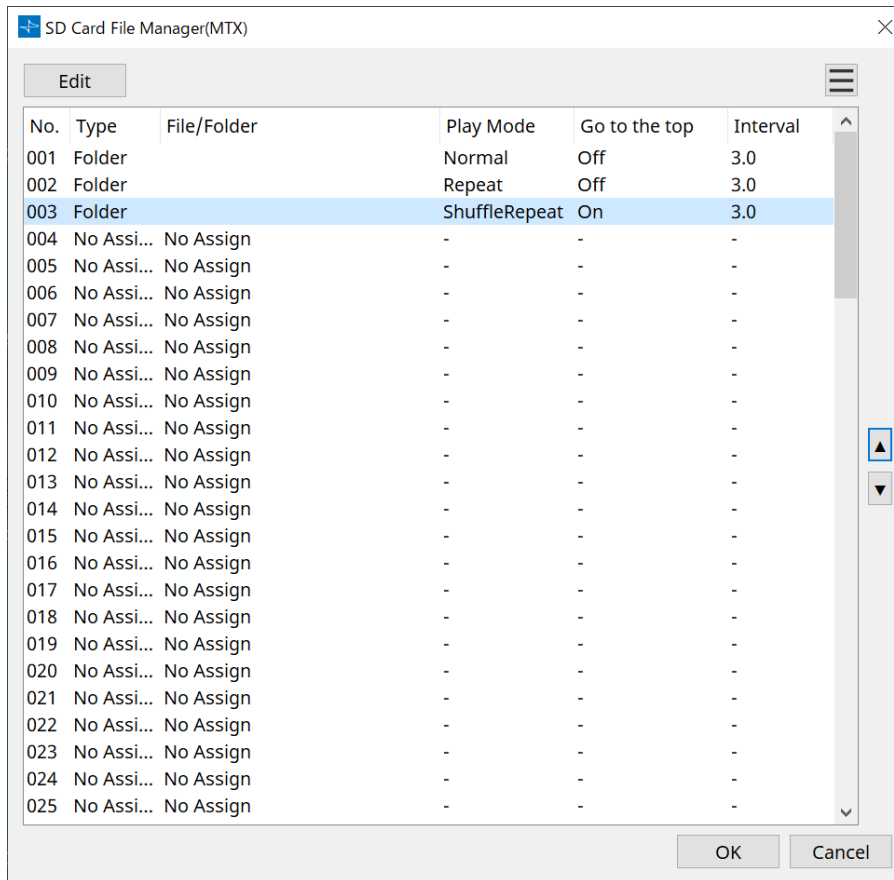

### 15.7.3. "Scheduler" dialog box

Click the [Tools] button on the device sheet and then click [Scheduler] to open this dialog.

You can switch presets or play back a song or sound effect from an SD memory card at a previously specified date and time. Each such setting is called an "Event".

#### <Usage example 1>

##### Switching background music by time period

Here's how you could switch the type of background music according to the time period, for example in a commercial establishment.

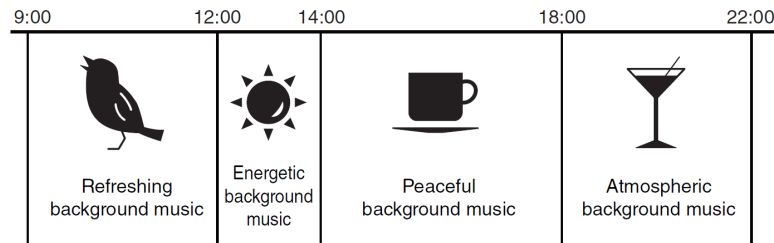

#### <Usage example 2>

##### Switching background music by day of the week

Here's how you could switch the type of background music according to the day of the week or the times of business, for example in a commercial establishment.

- **Monday–Friday**

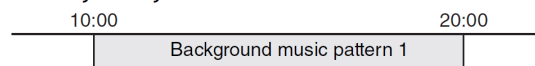

- **Saturday**

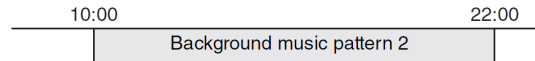

- **Sunday**

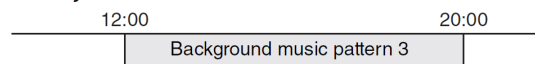

You can also specify exceptions, such as playing seasonal background music at Christmas, or stopping playback on days when the establishment is not operating.



- If an event has been assigned, the [SCHEDULER] indicator on the MTX front panel will be lit yellow. One minute before the event occurs, the indicator will flash.
- If more than one event is assigned at the same time, all events will run with one second of space between them. During this time, the [SCHEDULER] of the MTX's front panel will continue flashing.
- If the [Enable Daylight Saving Time] check box is selected in the "[Daylight Saving Time](#)" dialog box, events that have been scheduled within two hours before or after the start or end of daylight saving time will not be executed correctly.



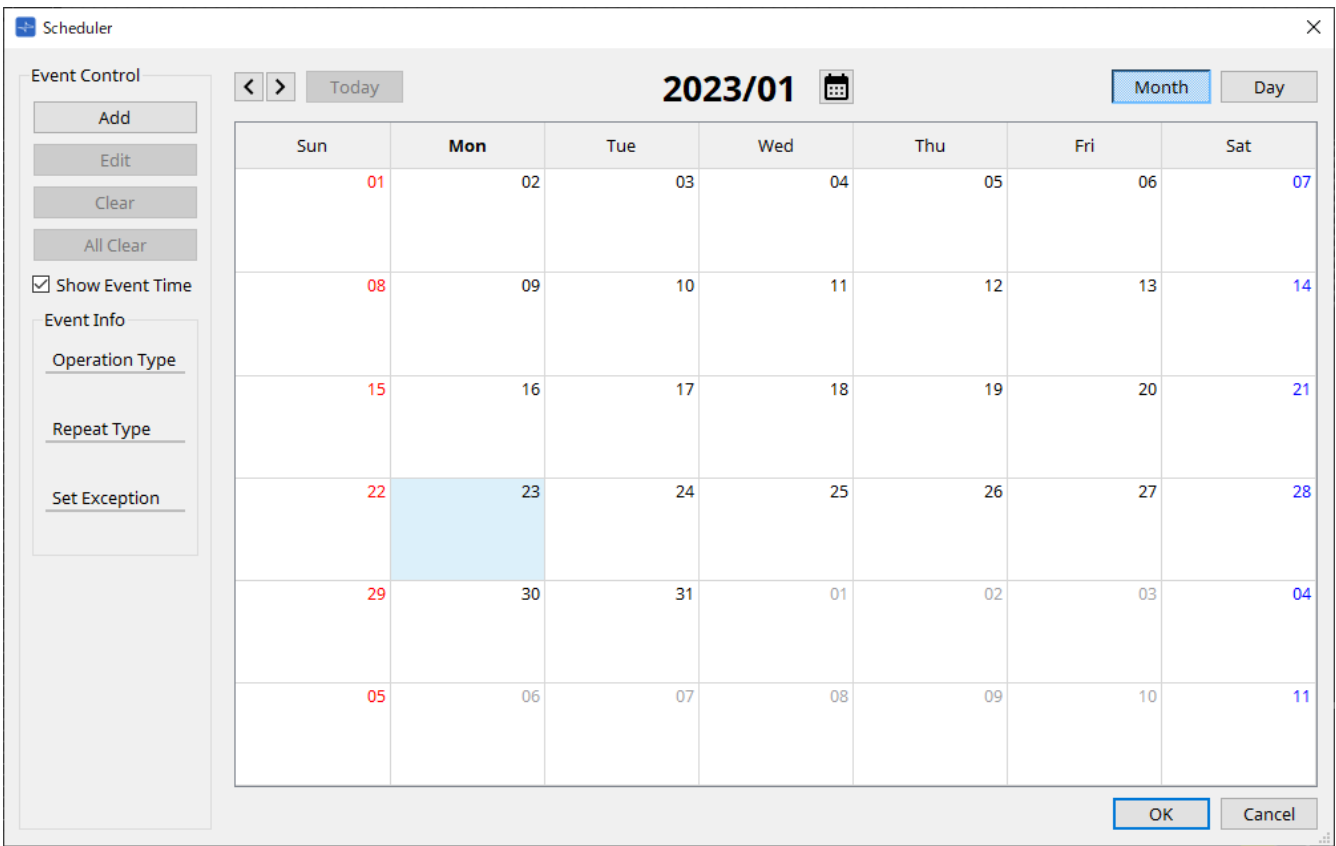

You can assign up to 50 events and 50 exceptions.

- **[Month] button/[Day] button**

Switch the calendar between month or day views.

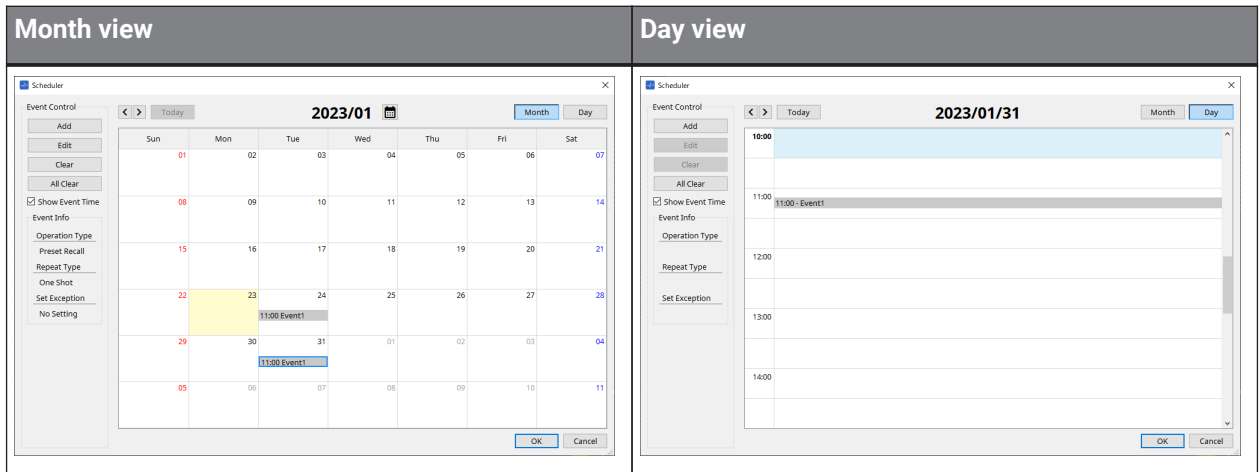

- In the calendar, double-click the date you want; the “Add Event” dialog box will appear, letting you add an event.
- Events other than repeating events can be moved by dragging and dropping them (in the month display you can move between days, and in the day display you can move between hours).
- In the month display, you can click the calendar icon to access a year/month selection screen.

- **[Today] button**

For the month view, displays this month’s calendar.  
 For the day view, displays today’s schedule.

- **[ < ]/[ > ] buttons**

For the month view, displays the previous or next month’s calendar.  
 For the day view, displays the previous or next day’s schedule.

- **Event Control**

- **[Add] button**

- The “Add Event” dialog box will appear.  
Here you can add an event.

- **[Edit] button**

- The “Edit Event” dialog box will appear.  
Here you can edit the contents of the currently selected event. If no event is selected, the button is dimmed.

- **[Clear] button**

- Deletes the currently selected event. If no event is selected, the button is dimmed.

- **[All Clear] button**

- Deletes all registered events.

- **[Show Event Time] check box**

- If this is selected, the time of the event is shown in the month display.

- **Event Info**

- This shows the information that was specified in the “Add Event” dialog box or “Edit Event” dialog box for the selected event.

- **Operation Type**

- Indicates the operation that will be executed when the event occurs.

- **Repeat Type**

- Indicates the frequency with which the event will occur.

- **Set Exception**

- Indicates a date and time for which, as an exception, the event will not occur.

- **[OK] button**

- Saves the settings and closes the dialog box.

- **[Cancel] button**

- Closes the dialog box without saving the changes.

**“Add Event” dialog box / “Edit Event” dialog box**

- **Event Name**

Enter the name of the event.

- **Event Operation**

**[Type] box**

Choose the operation that will be executed when the event occurs.



In the **“Recall Settings” dialog box** operations such as GPI Out or SD Song Select & Play can be included in the preset. Choose GPI Out if you want to control an external device via [GPI OUT] without recalling a preset, or choose SD Song Select & Play if you want to change the audio file that will play.

- **Preset Recall**

A preset will be recalled.

- **GPI Out**

The [GPI OUT] connector will be controlled.

- **SD Song Select & Play**

An audio file saved on the SD memory card will play or stop.

Set the playback file in the “SD Card File Manager” dialog box in advance.

- **Paging**

An audio message saved on the SD memory card will be played for the specified broadcast destination (ZONE).

- **Settings**

The contents will change depending on the event you chose in [Type] box.

- If you chose Preset Recall

Select the preset that you want to recall.

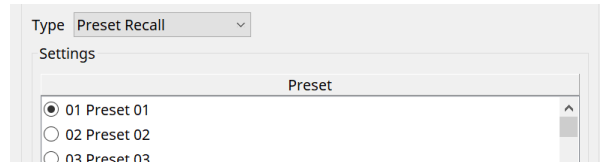

- If you chose GPI Out

Sets the state of the GPI OUT connector when an event is triggered.

The setting method is the same as for [GPI Out] in the "Recall Settings" dialog box.

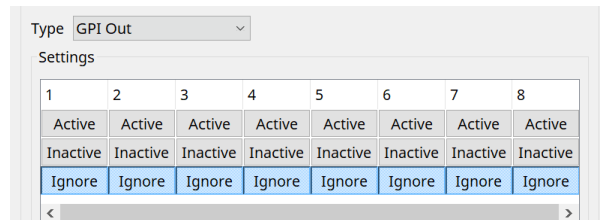

- If you chose SD Song Select & Play

Specify how the audio files saved on the SD memory card will play or stop when the event occurs.

- Pause

Stops the SD Card file being played when an event starts.

- Play

Play the file on the SD Card when the event starts.

Select the index number of the list in the "SD Card File Manager" dialog box.

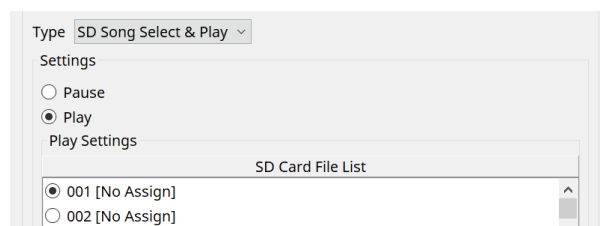

- If you chose Paging

Specify the ZONE/ZONE GROUP to which message files saved on the SD memory card will be broadcast when the event occurs.

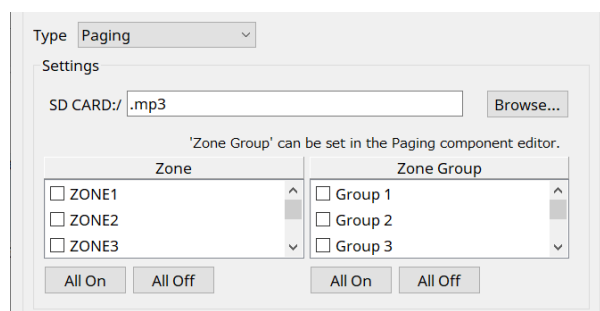

- **SD CARD:/**  
This indicates the selected message file.
- **[Browse] button**  
When you click this, a screen will appear, allowing you to select a message file.
- **[Zone]/[Zone Group]**  
These specify the Zone(s) and Zone Group(s) to which the broadcast is made. Multiple selections are possible for each.
- **[All On]/[All Off] button**  
Clicking these buttons turns all Zones or Zone Groups on or off.

Set ZONE GROUP in ZONE component > PAGING component editor, and set chime playback and function assignment to PGM1 buttons in PAGING component editor > Settings.

### • Event Schedule

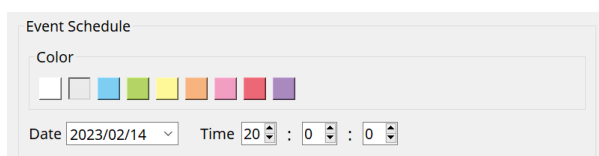

Specify the date and time at which the event will occur.

- **[Color] select switches**  
Choose the color of the event shown in the calendar. By specifying a color, you can make it easier to distinguish certain types of event.
- **[Date]**  
Specifies the date on which the event will occur. (year/month/day)  
You can change the date either by inputting it directly or by clicking the calendar that appears when you click the V icon at the right.  
Depending on the REPEAT EVENT setting described below, this might not be shown.
- **[Time]**  
Specifies the time at which the event will occur. (hour:minute:second, in 24-hour time)  
Click the hour/minute/second that you want to specify, and use the spin box or enter a value directly.  
If you select REPEAT EVENT and specify the event frequency as "Hourly," you'll only be able to set the minutes and seconds.

### • Repeat Event

By selecting this check box you can specify a repeating event.

- **[Yearly]/[Monthly]/[Weekly]/[Daily]/[Hourly] boxes**  
Specify the frequency with which the event will occur.
- **Event start date and time**  
Specify the date and time at which the event will occur repeatedly. The items that you can specify will depend on the frequency of the event.
  - **If the event frequency is [Yearly]**  
If [Day of the Month] is on, the event will occur each year at the date and time specified by "-month," "1st/2nd/3rd/4th," "day of the week," and [Time].  
If [Day of the Month] is off, the event will occur each year on the day selected in the calendar (shown in [Date]) at the time selected in [Time].

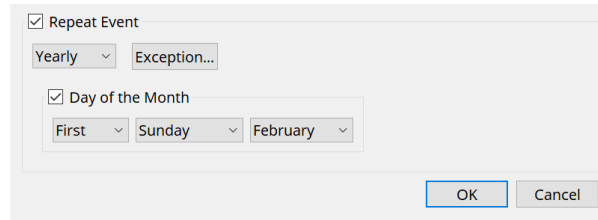

- **If the event frequency is [Monthly]**

If [Day of the Week] is on, the event will occur each month at the date and time specified by “1st/2nd/3rd/4th,” “day of the week,” and [Time].

If [Day of the Week] is off, the event will occur each month on the day selected in the calendar (shown in [Date]) at the time selected in [Time].

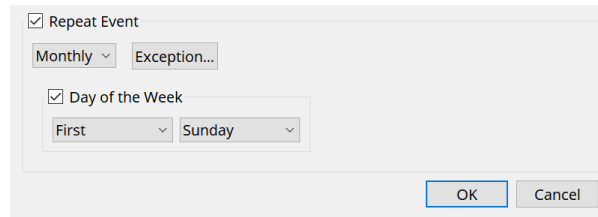

- **If the event frequency is [Weekly]**

The event will occur each week on the selected day of the week at the time specified by [Time].

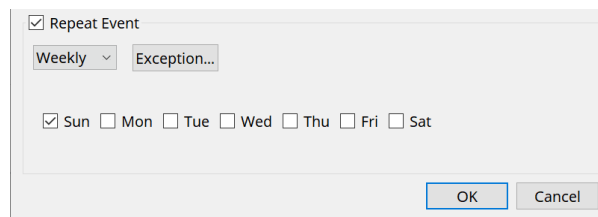

- **If the event frequency is [Daily]**

The event will occur each day at the time (hour:minute:second) specified by [Time].

- **If the event frequency is [Hourly]**

The event will occur each hour at the time (minute:second) specified by [Time].

- **[Exception] button**

The “[Event Exception](#)” dialog box will appear.

Here you can specify a date and time for which, as an exception, the repeating event will not occur.

- **[OK] button**

Saves the settings and closes the dialog box.

- **[Cancel] button**

Closes the dialog box without saving the changes.

## ■ “Event Exception” dialog box

Here you can specify a date and time for which, as an exception, the repeating event will not occur. The items that you can specify will depend on the frequency of the event.

Example) - Don't play background music on Wednesday, when the establishment is closed.

- Play special background music only for the event that occurs on the third Sunday of every month.

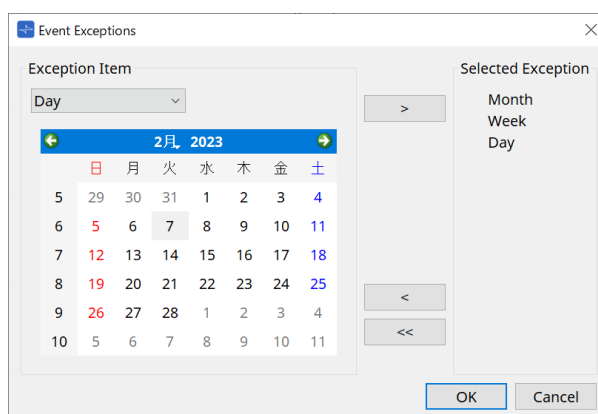

### • Exception Item

- If the event frequency is [Yearly]  
Specify the year for which the event will not occur.  
Only the [Year] can be specified.
- If the event frequency is [Monthly]  
Specify the month or day for which the event will not occur.  
Only the [Month] and [Day] can be specified.
- If the event frequency is [Weekly]  
Specify the month, week, or day for which the event will not occur.  
Only the [Month], [Week], and [Day] can be specified.
- If the event frequency is [Daily]  
Specify the month, week, day, or day of the week for which the event will not occur.  
Only the [Month], [Week], [Day], and [Day of the week] can be specified.
- If the event frequency is [Hourly]  
Specify the month, week, day, day of the week, or time (in hours) for which the event will not occur.  
The [Month], [Week], [Day], [Day of the week], and [Hour] can be specified.
- **[ > ] button**  
Adds a date and time that you want to specify as an exception to the list at the right.
- **[ < ] button**  
Removes a date and time that you specified as an exception from the list at the right.
- **[<<] button**  
Removes all dates and times that you specified as exceptions from the list at the right.
- **[OK] button**  
Saves the settings and closes the dialog box.
- **[Cancel] button**  
Closes the dialog box without saving the changes.

## 15.7.4. "GPI" dialog box

Click the [Tools] button on the device sheet and then click [GPI Input] or [GPI Output] to open this dialog. The use of the GPI functions is identical to the DME7, but the parameters that can be assigned with FUNCTION are different.

### ■ [GPI Input]

#### "Settings" dialog box

Function	Parameter1	Parameter2	InputType
No Assign			
MTX ON			
MTX Send ON			
MTX Priority Ducker ON			
MTX Dugan Automixer			
SD Play			
Preset Recall			
External Event			
MTX Level			
MTX Send Level			



For details of Input Type, refer to the DME7 GPI section.

#### Function

##### • [No Assign]

This setting is used to not change any of the settings for the controller's switches, knobs and sliders. [DEVICE] and [PARAMETER1/2] will be unavailable.

##### • [MTX ON]

The input voltage to the [GPI IN] connector will turn the parameter on/off. Select one of the following parameter types, and then make the appropriate setting.

- Input Ch ON
- Fx RTN ON
- ZONE Out ON
- Output Ch ON
- Input Ch Mute Group
- ZONE Out Mute Group



For the Input Ch Mute Group and ZONE Out Mute Group, the LED on the main unit turns off when the mute is ON.



- **[Parameter1]**  
Sets the parameter channel.
- **[Input Type]**  
Specifies how the input voltage to GPI IN will be applied to the parameter.  
You can choose [High Active], [Low Active], [Rising Edge], or [Falling Edge].
- **[MTX Send ON]**  
The input voltage to the [GPI IN] connector will control the send on/off of the channel.  
Select one of the following parameter types, and then make the appropriate setting.
  - Input Ch Send ON
  - Fx RTN Send ON
- **[MTX Priority Ducker ON]**  
The input voltage to the [GPI IN] connector will turn the zone's Ducker on/off.  
Select one of the following parameter types, and then make the appropriate setting.
  - 1st Priority
  - 2nd Priority
- **[MTX Dugan Automixer]**  
The input voltage to the [GPI IN] connector will turn the parameter on/off.  
Select one of the following parameter types, and then make the appropriate setting.
  - Override(main)
  - Mute(main)
  - override(Ch)
- **[SD Play]**  
The input voltage to the [GPI IN] connector will play the specified audio file.  
Select one of the following parameter types, and then make the appropriate setting.
  - SD Song Select & Play
  - SD Song Pause
  - **[Input Type]**  
Specifies how the input voltage to GPI IN will be applied to the parameter.  
You can choose [Rising Edge] or [Falling Edge].
- **[Preset Recall]**  
The input voltage to the [GPI INPUT] connector will recall the specified preset.
  - **[Parameter1]**  
Select the preset number that you want to recall.
  - **[Input Type]**  
Specifies how the input voltage from GPI IN will be applied to the parameter.  
You can choose [Rising Edge] or [Falling Edge].

- **[External Event]**

Input voltage to the [GPI IN] connector will trigger the output of the commands specified in the “External Events” dialog box.

- **[Parameter1]**

Select the name of the event to be executed.

- **[Input Type]**

Specifies how the input voltage to GPI IN will be applied to the parameter.

You can choose [High Active], [Low Active], [Rising Edge], or [Falling Edge].

If you selected [On/Off] for the [Command Type], the following action will occur:

<b>[High Active]</b>	If the input voltage is high, the command assigned to [Command - On] will be transmitted. If the input voltage is low, the command assigned to [Command - Off] will be transmitted.
<b>[Low Active]</b>	If the input voltage is low, the command assigned to [Command - On] will be transmitted. If the input voltage is high, the command assigned to [Command - Off] will be transmitted.
<b>[Rising Edge]</b>	Each time the input voltage becomes high, the command assigned to [Command - On] and the command assigned to [Command - Off] will be transmitted alternately.
<b>[Falling Edge]</b>	Each time the input voltage becomes low, the command assigned to [Command - On] and the command assigned to [Command - Off] will be transmitted alternately.

- **[MTX Level]**

The input voltage to the [GPI IN] connector will control the level of the channel.

If the maximum level cannot be reached because of the length of the cable, adjust the maximum and minimum input voltage values in the “GPI Calibration” dialog box.

Select one of the following parameter types, and then make the appropriate setting.

- Input Ch Level
- Fx RTN Level
- Matrix Out Level
- ZONE Out Level
- Output Ch Level
- 1st Priority Mix Level
- 2nd Priority Mix Level
- Input Ch DCA Group
- ZONE Out DCA Group

- **[Parameter1]**

Specifies the channel whose level you want to control.

- **[Input Type]**

Specifies how the level to GPI IN will be applied to the parameter.

You can select [Analog] or [Analog Inv.].

- **[Upper Limit]/[Lower Limit]**  
Use [Upper Limit] and [Lower Limit] to specify the range in which the level can be varied. By using [Parameter Range] you can limit the range in which the user can control the volume. For example you can use this to specify the maximum volume of background music, or use a controller to make fine volume adjustments in a narrow range of  $-6\text{ dB} - +6\text{ dB}$ .
- **[MTX Send Level]**  
The input voltage to the [GPI IN] connector will control the send level of the channel. If the maximum level cannot be reached because of the length of the cable, adjust the maximum and minimum input voltage values in the "GPI Calibration" dialog box. Select one of the following parameter types, and then make the appropriate setting.
  - Input Ch Send Level
  - Fx RTN Send Level

## ■ [GPI Output] dialog box

### "Settings" dialog box

Function	Parameter1	Parameter2	OutputType
No Assign			Closed
MTX ON			Open
MTX Send ON			Pulse
MTX Priority Ducker ON			Pulse Inv.
MTX Dugan Automixer			
SD Song Play			
MTX Level			
MTX Send Level			
Alert			



For details of Output Type, refer to the DME7 GPI section.

## Function

- **[No Assign]**  
[OUTPUT TYPE] specifies the polarity of the output signal when an alert occurs. No other function are specified; they will be the default.
  - **[Output Type]**  
Controls the GPI OUT when a preset is recalled or when a Scheduler event is executed.
- **[MTX ON]**  
Parameter on/off operations will control the GPI Output. Select one of the following parameter types, and then make the appropriate setting.
  - Input Ch ON

- 
- Fx RTN ON
  - ZONE Out ON
  - Output Ch ON
  - Input Ch Mute Group
  - ZONE Out Mute Group
  - **[Parameter1]**  
Specify the channel that will control the on/off setting of the parameter.
  - **[Output Type]**  
Specifies how output will occur from the [GPI OUT] connector.  
You can choose [Closed], [Open], [Pulse], [Puse Inv.] or [Falling Edge].
  - **[MTX Send On]**  
Send on/off operations will control the GPI Output.  
Select one of the following parameter types, and then make the appropriate setting.
    - Input Ch Send ON
    - Fx RTN Send ON
  - **[MTX Priority Ducker ON]**  
On/off operations of the zone's Ducker will control the GPI Output.  
Select one of the following parameter types, and then make the appropriate setting.
    - 1st Priority
    - 2nd Priority
  - **[MTX Dugan Automixer]**  
Parameter on/off operations will control the GPI Output.  
Select one of the following parameter types, and then make the appropriate setting.
    - Override(master)
    - Mute(master)
    - override(Ch)
    - **[Parameter1]**  
For Override (master) and Mute (master), select the group that controls on/off. For override (Ch), select the channel that controls on/off.
    - **[Output Type]**  
Specifies how output will occur from the [GPI OUT] connector.
  - **[SD Song Play]**  
The status of audio file playback will be output to the [GPI OUT] connector.
    - **[Output Type]**  
Specifies how output will occur from the [GPI OUT] connector.
  - **[MTX Level]**  
Controls the GPI Output according to the level (volume changes) of each channel. You can use this to fader-start a CD player, or to light an indicator when high volume occurs.  
Select one of the following parameter types, and then make the appropriate setting.
    - Input Ch Level
    - Fx RTN Level
    - Matrix Out Level
    - ZONE Out Level
    - Output Ch Level
-

- 1st Priority Mix Level
- 2nd Priority Mix Level
- Input Ch DCA Group
- ZONE Out DCA Group
- **[Parameter1]**  
Specify the channel that will be used to control the [GPI OUT] connector.
- **[Output Type]**  
Specifies how output will occur from the [GPI OUT] connector.
- **[MTX Send Level]**  
You can use this to fader-start a CD player, or to light an indicator when high volume occurs. Select one of the following parameter types, and then make the appropriate setting.
  - Input Ch Send Level
  - Fx RTN Send Level
- **[Alert]**  
A signal will be output to the [GPI OUT] connector when an alert occurs.
  - **[Parameter1]**  
Select the type of alert from the following. For details on the type of alert that is output, refer to "Alert list".
    - Fault, Error, Warning
    - Fault, Error
    - Fault
  - **[Output Type]**  
Only Closed can be selected. If an alert is occurring, the [GPI OUT] connector will be closed. The closed state will continue until the alert has been cleared.

## 15.7.5. “External Events” dialog box

Click the [Tools] button on the device sheet and then click [External Events...] to open this dialog. Here you can make settings for a command that will be transmitted to the network to which the Dante connector or NETWORK connector is connected. This command can be triggered by recalling a preset on the MTX; or by input from GPI IN; or by operation of an external device such as a DCP unit.



Only commands are transmitted, and any reply to the commands will be discarded.

You can set up to 20 events. You can set up to 5 commands per event.

- **Menu button (☰)**

Click this button to execute the following functions.

- **[Copy Event]**  
Copies the contents of the selected event to the copy buffer.
- **[Copy All Event]**  
Copies the contents of all events to the copy buffer.
- **[Paste Event]**  
Overwrites the event settings in the copy buffer.
- **[Clear Event]**  
Initializes the contents of the selected event.
- **[Clear All Event]**  
Initializes the contents of all events.

- **[Event No.] list box**

Specify the event number.

- **[Event Mode] list box**

Specify whether the triggered command is the [On/Off] or [1 shot] type.

When an event is assigned to the button on an external device, such as a DCP unit, each command type will cause the following operation:

- **[On/Off]**  
Pressing the assigned button repeatedly will cause the MTX to transmit the On command and Off command alternately.
- **[1shot]**  
Pressing the assigned button will cause the MTX to transmit the programmed command.

- **[Event Name] text box**

Specify the name of the event.

- **[Test - On]/[Test - Off] button**

ProVisionaire Design will directly transmit commands specified in the “Controlled Device” table in numerical order. If [1shot] has been selected in the [Command Type] list box, the [Test - Off] button will be disabled.



You can execute command transmission on-line or off-line.

- **“Controlled Device” table**

Specify information for the device that will receive commands. When the device receives a trigger signal, it will transmit commands in numerical order, as shown in the table.

For details on settings for the receiving device, refer to the documentation for the corresponding device regarding commands.

- **[Protocol] list box**

Select the protocol supported by the device that receives the commands.

- **[IP Address] text box**

Specify the IP address of the device that receives commands.

- **[Port No.] text box**

Specify the port number of the device that receives commands.

- **[Comments] text box**

You can enter up to 32 bytes of text. This text could be a device name that would help you identify the device.

- **[Copy] button**

Copies the information for the selected command specified in the “Controlled Device” table and Command text box to the copy buffer.

- **[Paste] button**

Pastes (and overwrites) the information from the copy buffer into the “Controlled Device” table and Command text box.

- **[Test] button**

ProVisionaire Design will directly transmit commands that are entered in the Command text box.

- **[Overwrite] / [Insert] button**

Click this button repeatedly to toggle between Overwrite and Insert. While the [Insert] button is displayed, you can insert a hexadecimal number at the beginning or in the middle of the text in the Command text box.

- **Command text boxes**

If [On/Off] has been selected in the [Event Mode] list box, repeatedly pressing the button on an external device, such as a DCP unit, will cause the MTX to transmit the On command and Off command alternately. If [1shot] has been selected in the [Event Mode] list box, repeatedly pressing the button on an external device, such as a DCP unit, will cause the MTX/MRX to transmit the programmed commands.

Commands should be hexadecimal numbers, and entered in the format of XX.

If a command for controlling an external device is expressed by a text string in the relevant specification document, use the Converter area to convert the text string into a hexadecimal number.



The maximum command length is 128 bytes.

- **[Converter>>] button**

Displays an area where you can convert a text string into a hexadecimal number.

- **[ASCII to Hex]/[Hex to ASCII] option button**

Select whether you want to convert a text string to a hexadecimal number or vice versa.

- **[ASCII]/[Hex] text box**

The upper text box name will be ASCII or Hex, depending on the selection of the [ASCII to Hex]/[Hex to ASCII] radio buttons.

Click the [Convert] button to display the conversion result in the lower text box.

- **[Reset] button**

Erases the contents in the [ASCII]/[Hex] text boxes.

- **[To Command] button**

Displays the hexadecimal command (that has been converted from the text string) in the Command text box.

If you selected [On/Off] in the [Command Type] list box, the [Command - On] button and [Command - Off] button will appear to let you choose which button the command should be applied to.

- **[OK] button**

Updates the settings and closes the dialog box. If the IP address or the command format is invalid, an error message will appear and the dialog box will not close.

- **[Cancel] button**

Closes the dialog box without updating the settings.



## 15.7.6. "Recall Settings" dialog box

Click on [Recall Settings] in the "Presets" area of the device sheet to open this dialog. Configures settings related to the DCP library and External Event that are recalled at the same time when a preset is recalled.

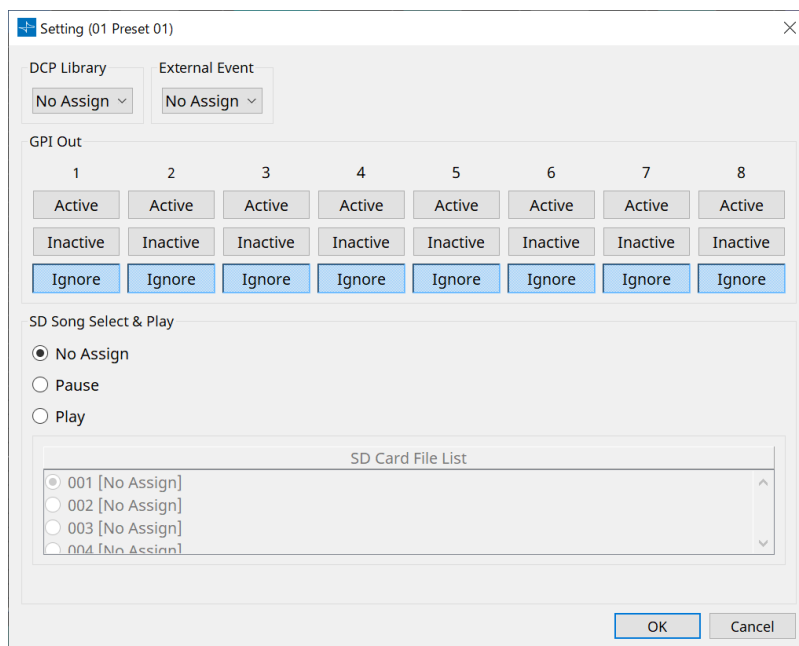

- **DCP Library**

Selects the DCP library to be recalled at the same time when a preset is recalled.

- **External Event**

Selects the Event to be output at the same time when a preset is recalled. Select the event number set in the "External Events" dialog box.

- **GPI Out**

Configures the GPI OUT setting that is output at the same time when a preset is recalled. An external device connected to the [GPI OUT] terminal on the main unit is controlled using the output of GPI OUT.

### **[Active]/[Inactive]/[Ignore] button**

Specify whether the GPI OUT connector's output will be enabled (Active), enabled with the OUTPUT TYPE inverted (Inactive), or ignored (Ignore).

If the [OUTPUT TYPE] in the GPI Output dialog is set to [Pulse] or [Pulse Inv.], only [Active] or [Ignore] can be selected.

If in the "Settings" dialog box, the [OUTPUT TYPE] setting is set to [Pulse] or [Pulse Inv.], the only available choices will be [Active] and [Ignore].

- If [Active] is specified

When [OUTPUT TYPE] is [ Closed], the [GPI OUT] pin will be closed (connected to ground).

When [OUTPUT TYPE] is [ Open], the [GPI OUT] pin will be open.

When [OUTPUT TYPE] is [ Pulse], the [GPI OUT] pin will be closed (connected to ground) for approximately 250 ms.

When [OUTPUT TYPE] is [ Pulse Inv.], the [GPI OUT] pin will be open for approximately 250 ms.

- If [Inactive] is specified

When [OUTPUT TYPE] is [ Closed], the [GPI OUT] pin will be open.

When [OUTPUT TYPE] is [ Open], the [GPI OUT] pin will be closed (connected to ground).

- If Ignorel is specified  
There will be no change in the output. Use this setting if a different function is assigned to GPI OUT and you don't want that function to be affected by preset recall.
  - **SD Song Select & Play**
- Pause  
Stops the file being played at the same time as preset recall.
- Play  
Plays the specified file at the same time as preset recall.  
Specifies the index number of the list in the "SD Card File Manager" dialog box.

## 15.7.7. "Recall Filter" dialog box

Click on [Recall Filter] in the "Presets" area of the device sheet to open this dialog.

Here you can specify which parameters will be recalled when you recall a preset. For example if the input/output levels do not change for any of the presets, you can exclude the INPUT LEVEL and OUTPUT LEVEL from recall, so that the level settings can stay the same without your having to re-specify the levels for each preset.

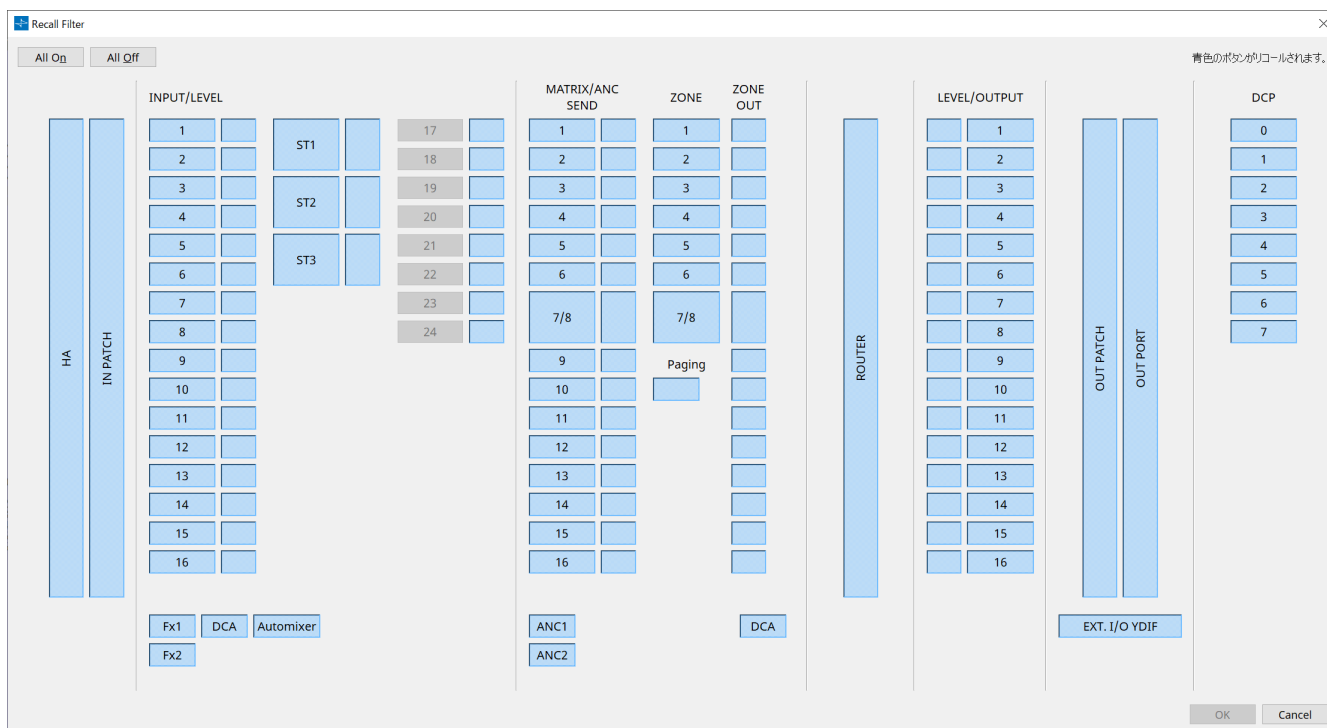

- **[All On] button**

Turns on (blue) all of the buttons. All parameters will be recalled.

- **[All Off] button**

Turns off (white) all of the buttons. None of the parameters will be recalled.

- **Parameter select buttons**

- **[HA] button**

If this is on, the HA gain and phantom power (+48V) settings of the input ports will be recalled.

- **[IN PATCH] button**

If this is on, the input patch settings and input channel names will be recalled.

These buttons include patching to the MY4-AEC input channels From Far-end, Farend Voice, Near-end Mic., Near-end Voice, and To Far-end.

- **[INPUT]/[LEVEL] button**

If the [INPUT] button is on, the following input channel settings will be recalled.

**Input channels:** Phase, HPF, Digital Gain, PEQ, COMP, GATE, AGC, FBS, Insert on/off

Insert on/off is only for the MTX5-D.

**Stereo input channels:** Digital Gain, PEQ, AGC, COMP

If the [LEVEL] button is on, the input channel level and on/off (mute) settings will be recalled.

These can be specified individually for each channel.



In the "MTX Configuration" dialog box, if [INPUT PORT SETUP] is changed from "MONO x2" to "STEREO," the settings of the [INPUT]/[LEVEL] buttons will follow the "L" side.

- **[Fx1]/[Fx2] button**

If these buttons are on, the effect type and the following settings will be recalled.

- Send level from the input channel to the effect bus, send on/off
- Effect return level, on/off (mute)
- Effect return name

- **[DCA] button (INPUT side)**

If this is on, the following settings will be recalled.

- The input channel's assignment to DCA or mute group
- Main level of the DCA group
- Main mute of the mute group

- **[Automixer] button**

If this is on, the settings of the Dugan Automixer will be recalled.

- **[MATRIX SEND] button**

If the button at the left is on, the following settings will be recalled. If the button at the right is on, the matrix out level will be recalled.

- Send level from the input channel to the matrix bus, send on/off, and stereo channel pan
- Send level from effect return to the matrix bus, send on/off, and stereo channel pan

- **[ANC1 SEND]/[ANC2 SEND] button**

If these buttons are on, the send level from the input channel to the ANC bus and the send on/off status will be recalled.

- **[ZONE] button**

If this is on, the following settings will be recalled.

- Priority Source of 1st Priority, Mix Level, Ducker
- Priority Source of 2nd Priority, Mix Level, Ducker
- ANC
- Zone name



In the "MTX Configuration" dialog box, if [INPUT PORT SETUP] is changed from "MONO x2" to "STEREO," the setting of the [ZONE] button will follow the oddnumbered zone.

- **[PAGING] button**

Turning this on recalls the setting of the PAGING [ON] button.

- **[ZONE OUT] button**

If this is on, the ZONE Out Level and on/off (mute) will be recalled.

- **[DCA] button (ZONE side)**

If this is on, the following settings will be recalled.

- ZONE Out's channel assignment to DCA or mute group
- Main level of the DCA group
- Main mute of the mute group

- **[ROUTER] button**

If this is on, the router settings will be recalled.

- **[LEVEL]/[OUTPUT] button**

If the [LEVEL] button is on, the output channel level and on/off (mute) settings will be recalled.

If the [OUTPUT] button is on, the Room EQ, Delay, and Speaker Processor settings will be recalled. These can be specified individually for each channel.

- **[OUT PATCH] button**

If this is on, the output patch settings and output channel names will be recalled.

- **[OUT PORT] button**

If this is on, the output port's output gain and polarity settings will be recalled.

- **[EXT. I/O YDIF] button**

If this is on, settings for the audio that is output from the MTX to YDIF when in Distribution mode will be recalled.

- **[DCP] button**

If this is on, the parameter assignments of the DCP (digital control panel) unit connected to the MTX/MRX will be recalled. The button shows the ID of the DCP.

- **[MY4-AEC] button (MTX5-D only)**

If this is on, the settings of the MY4-AEC installed in the MTX5-D will be recalled.

The following settings are outside the recall settings of the [MY4-AEC] button.

- From Far-end, Far-end Voice, Near-end Mic., Near-end Voice, and To Far-end (included in the [IN PATCH] button range)
- SRC

### 15.7.8. "Sampling Rate Converter" dialog box

Click to open "Sample Rate Converter" in the context menu of the "Slot In" or "Slot Out" component editor. Here you can turn on/off the SRC (Sampling Rate Converter) of the MY4-AEC or MY8-AE96S that is installed in the device's slot, and specify the word clock setting of the output.

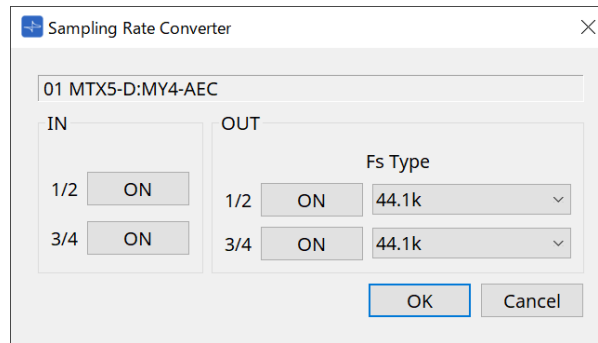

- **[ON] button**  
Switches the SRC on/off. The button also shows the on/off status.
- **[Fs Type] box (MY4-AEC only)**  
This selects the word clock that will be output from the MY4-AEC when SRC is on. If you select AES/EBU\_IN\_CH1/2, the word clock that is received at input 1/2 of the MY4-AEC will be output. If you select AES/EBU\_IN\_CH3/4, the word clock that is received at input 3/4 of the MY4-AEC will be output.
- **[OK] button**  
Applies the settings and closes the dialog box.
- **[Cancel] button**  
Closes the dialog box without applying the settings.

## 15.8. Alert list

The alerts generated by MRX7-D/MTX5-D/MTX3 units, and their significance and the appropriate actions, are listed below.

If the problem is not solved, please contact your Yamaha dealer.

Alert number	Meaning	Response
01–09	The device has not started up correctly.	Turn the power off, then turn on after waiting at least 6 seconds. If this does not solve the problem, please initialize the memory. Should this also fails, contact your Yamaha dealer.
10	The internal backup battery has been completely exhausted or is not installed.	When you turn off the power, the current settings will be lost, and will return to the default values. Please stop use immediately, and contact your Yamaha dealer.
11	The internal backup battery has run extremely low, and it is possible that the internal memory has been cleared.	When you turn off the power, the current settings will be lost, and will return to the default values. Please stop use immediately, and contact your Yamaha dealer.
12	The internal backup battery has only a small amount of power remaining.	This does not affect the operation of the device. However, if you continue using the device, the settings may be lost and reset to the default values. Contact your Yamaha dealer as soon as possible.
13	A problem has occurred with the internal clock, and it has been initialized (January 1, 2000, 0:00).	If this occurs each time you turn on the power, it is possible that the internal backup battery has run down or that the device has malfunctioned. Contact your Yamaha dealer. If this occurs only once, an abnormality was detected with the clock setting and it was initialized; use ProVisionaire Design to set the time.
14	The current preset saved in internal memory has been lost.	Recall the preset. If this does not solve the problem, contact your Yamaha dealer.
15	The settings saved in internal memory have been lost.	Either the internal backup battery has run low, or the device has malfunctioned. Contact your Yamaha dealer.
20	An unsupported Mini-YGDAI card is inserted in the slot, or the inserted Mini-YGDAI card has malfunctioned.	Replace the card with a supported Mini-YGDAI card or check that the supported Mini-YGDAI card is working correctly in another Host.
21	The word clock leader has become unlocked.	Make sure that the word clock signal is being input correctly.
22	The digital signal being input to the [YDIF IN] connector is not synchronized to the word clock of this device.	Make sure that YDIF cables are properly connected. Use cables that meet the required specifications.
23	The digital signal being input to the [YDIF IN] connector is not continuously synchronized to the word clock of this device.	

Alert number	Meaning	Response
24	The digital signal being input to the slot is not synchronized to the word clock of this device.	Either input a signal that is synchronized, or specify the slot as the word clock leader.
25	The digital signal being input to the slot is not continuously synchronized to the word clock of this device.	
26	The digital signal being input to the Dante connector is not synchronized to the word clock of this device.	Either input a signal that is synchronized, or specify the Dante as the word clock leader.
27	The digital signal being input to the Dante connector is not continuously synchronized to the word clock of this device.	
28	The Dante sampling frequency has been changed to match the word clock leader of this unit.	Check the word clock setting of this unit. Then set the sampling frequency of the Dante network.
30	There is a problem with the connection of the [YDIF IN] connector.	Make sure that YDIF cables are properly connected. Use cables that meet the required specifications.
40	Duplicate IP addresses.	Change the IP addresses so that there are no duplicates.
41	IP address was not set within 60 seconds of startup.	Please check rear panel DIP switch 6 (IP Setting). If DIP switch 6 is set to "PC," use ProVisionaire Design or DHCP server to specify the device IP address.
42	A device within the MTX system was not found on the network.	Power-on all devices in the system, and make sure that they are correctly connected to the network.
43	Too many devices are connected to the network.	Reduce the number of devices connected to the network.
46	Dante transmission flow count exceeded the limit.	Maximum Dante Flow rate exceeded. Try changing parts of transmission flows to Multicast using Dante Controller.
50	The UNIT ID is set to "00."	Set the UNIT ID to something other than "00."
51	Devices with identical UNIT IDs were found connected within the same network.	Change the UNIT ID so that there are no duplicates.
52	A communication error occurred with the [DCP] connection.	<ul style="list-style-type: none"> <li>• If an error was shown in the DCP panel, refer to the DCP owner's manual and take the appropriate action.</li> <li>• Ensure that the panel ID of the DCP units do not conflict.</li> <li>• Verify that the cables are correctly connected and are within the specified length.</li> </ul>
53	[The DCP connected to the [DCP] connector has been configured differently from the project settings.	<ul style="list-style-type: none"> <li>• Check that the required DCP is connected.</li> <li>• Check whether a different model of DCP might be connected.</li> </ul>
56	SD memory card was not recognized.	Use an SD memory card that complies with the specifications.



Alert number	Meaning	Response
58	Unable to play the specified file or folder in the SD player.	Verify that the specified audio file or folder exists in the SD memory card. There must be at least one playable audio file in the specified folder.
60	A preset recall attempt has failed.	Initialize the memory of the device. If this does not solve the problem, contact your Yamaha dealer.
61	The recall could not be executed because the preset to be recalled when the MTX starts up was not found.	Specify a preset that exists. No sound will be output unless an appropriate preset is recalled.
64	The preset could not be recalled.	<ul style="list-style-type: none"> <li>• The Preset selected for recall cannot be recalled as no data has been stored to it.</li> <li>• Another device may have been added after presets were stored. Please synchronize and check all presets using ProVisionaire Design, edit as necessary and store again.</li> </ul>
70	Synchronization has not been completed. It may be that synchronization was halted before completion.	Perform synchronization again using ProVisionaire Design. If this does not solve the problem, initialize the memory of the device and synchronize again. If this also fails, contact your Yamaha dealer.
71	The UNIT ID settings when synchronization was performed do not match the current UNIT ID settings.	Do not change any UNIT ID's after performing synchronization. If you've changed any UNIT ID's, perform synchronization again.
72 (MRX7-D/MTX5-D)	Because this device has Dante Device Lock enabled, the settings of device DIP switches and ProVisionaire Design do not match current Dante settings.	If you have Dante Device Lock enabled, please disable using Dante Controller, review device DIP switch settings and ProVisionaire Design's Dante settings, and edit as necessary to match the current situation.
80 (MRX7-D only)	The audio file for the Speech Privacy component does not exist.	Install it using the Install Speech Privacy File dialog.

## 15.9. Component editors

When you double-click a component in the device sheet, the component editor opens.

Here we explain the MTX-specific component editor. For details about other components, refer to the "ProVisionaire Design DME7 Component Guide" .

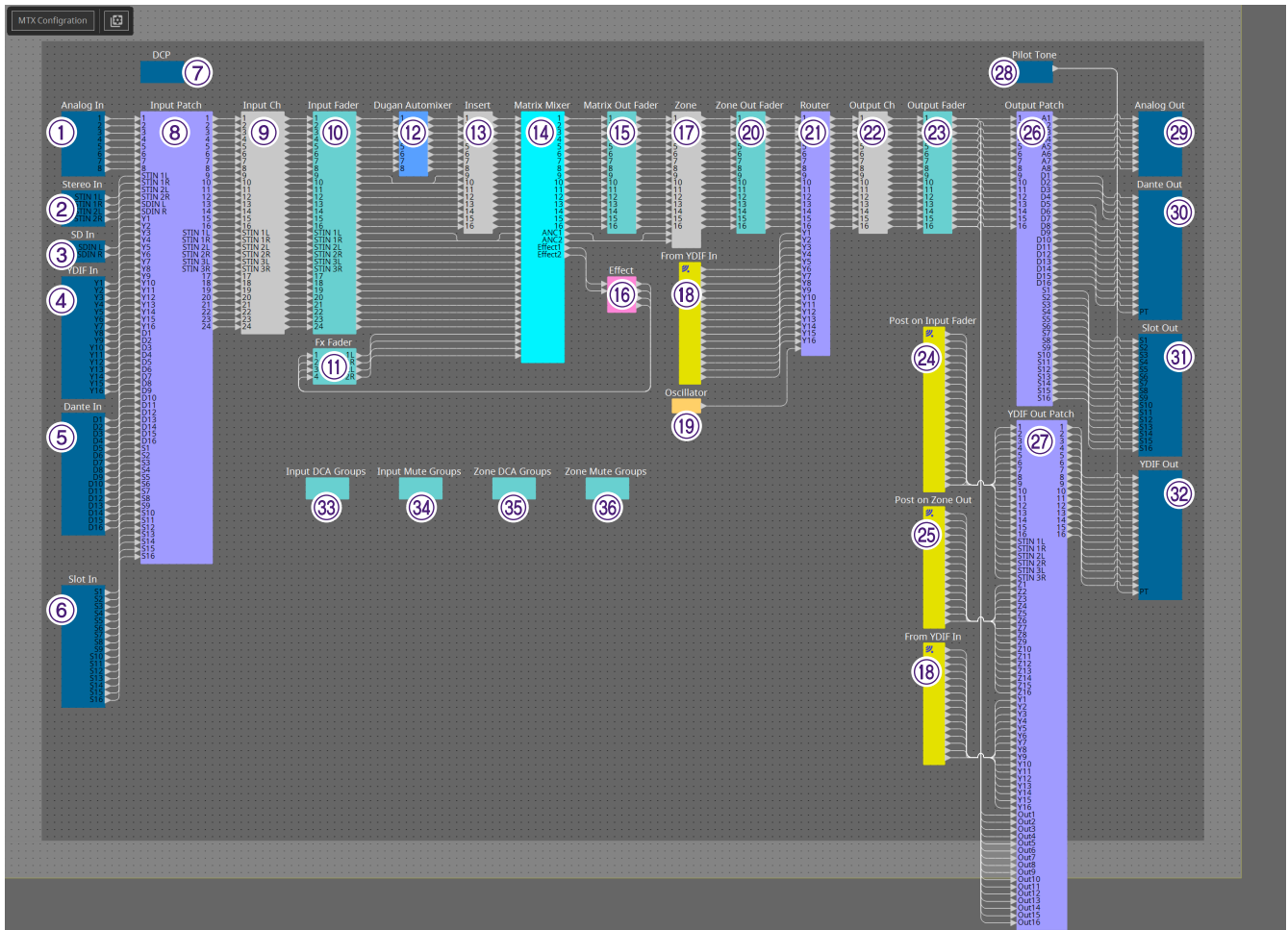

Number	Component name	Details	Link
①	Analog In	Displays the settings related to the [INPUT] terminal input and the level of the audio signal being input.	<a href="#">"Analog In" component editor</a>
②	Stereo In	Displays the audio signal level being input from the [ST IN] terminal.	---
③	SD In	Sends the audio signal that is being played from SD memory.	---
④	YDIF In	Displays the audio signal level input from the [YDIF] terminal.	---
⑤	Dante In(MTX5-D only)	Sends the audio signal input from the [Dante] terminal.	---

Number	Component name	Details	Link
⑥	Slot In(MTX5-D only)	Displays the audio signal level being input from the Mini-YGDAI card.  Right-click the [Slot in] or [Slot Out] component, select the "Mini-YGDAI Card" in the context menu and then select the MY4-AEC card "MY4-AEC " component will be displayed.	<a href="#">"MY4-AEC" component editor</a>
⑦	DCP	Sets the DCP control panel.	<a href="#">"DCP"</a>
⑧	Input Patch	Assigns the input source to an input channel.	--
⑨	Input Ch	Performs signal processing for input channels.	<a href="#">"Input CH" component editor</a>
⑩	Input Fader	Adjusts the level of the input channel.	--
⑪	Fx Fader	Adjusts the level of the effect return.	--
⑫	Dugan Automixer	In speech applications, the MTX3 automatically adjusts the auto-mix gain for input channels 1 to 4, and the MTX5-D automatically adjusts the auto-mix gain for input channels 1 to 8.	<a href="#">"ProVisionaire Design DME7 Component Guide"</a>
⑬	Insert (MTX5-D only)	Turns the Mini-YGDAI card insert ON or OFF.	<a href="#">"Insert" component editor</a>
⑭	Matrix Mixer	Mixes the input channel signals and sends them to each ZONE.	<a href="#">"ProVisionaire Design DME7 Component Guide"</a>
⑮	Matrix Out Fader	Adjusts the level from the matrix mixer to the ZONE.	--
⑯	Effect	Adjusts the effect(s).	--
⑰	Zone	This screen is used to specify settings related to the PGM1 (MTX5-D only) and to output signals based on the priority of the input signal.	<a href="#">"Zone" component editor</a>
⑱	From YDIF In	The input signal from the ④ [YDIF IN] terminal.	--
⑲	Oscillator	Outputs the oscillator signal.	--
⑳	Zone Out Fader	Adjusts the ZONE output level.	--
㉑	Router	Assign signals to output channels.	<a href="#">"ProVisionaire Design DME7 Component Guide"</a>

Number	Component name	Details	Link
⑫	Output Ch	Performs signal processing on the output channel.	<a href="#">"Output CH" component editor</a>
⑬	Output Fader	Adjusts the level of the output channel.	---
⑭	Post on Input Fader	The output signal from ⑩ [Input Fader] or ⑫ [Dugan Automixer].	---
⑮	Post on Zone Out	The output signal from ⑳ [Zone Out Fader].	---
⑯	Output Patch	Assigns output signals to the various types of output terminals.	---
⑰	YDIF Out Patch	Assigns output signals to the [YDIF] terminal.	---
⑱	Pilot Tone	Sets the pilot tone.	<a href="#">"Pilot Tone" component editor</a>
⑲	Analog Out	Displays the settings related to the [OUTPUT] terminal output and the level of the audio signal being output.	<a href="#">"Analog Out" component editor</a>
⑳	Dante Out (MTX5-D only)	Specifies the Dante output-related settings.	<a href="#">"ProVisionaire Design DME7 Component Guide"</a>
㉑	Slot Out (MTX5-D only)	Displays the settings related to the Mini-YGDAI card output and the level of the audio signal being output.	<a href="#">"Slot Out" component editor</a>
㉒	YDIF Out	Outputs to the [YDIF] terminal.	---
㉓	Input DCA Groups	Sets the DCA group for the input channel.	<a href="#">"DCA Groups"/"Mute Groups" component editor</a>
㉔	Input Mute Groups	Sets the mute group for the input channel.	<a href="#">"DCA Groups"/"Mute Groups" component editor</a>
㉕	Zone DCA Groups	Sets the DCA group for the ZONE output.	<a href="#">"DCA Groups"/"Mute Groups" component editor</a>
㉖	Zone Mute Groups	Sets the mute group for the ZONE output.	<a href="#">"DCA Groups"/"Mute Groups" component editor</a>

### 15.9.1. "Analog In" component editor

Here you can make settings to the HA (head amp) of the [INPUT] jack, and view the levels of the audio signals that are being input.



① **Channel index**

Indicates the analog input jack number.

② **Level meter**

Indicates the analog input level.

③ **[GAIN] knob**

Adjusts the analog gain of the HA (head amp).

④ **[+48V] button**

Turns the HA phantom power (+48V) on/off.

**! Notice**

Be sure to leave this button off if you do not need phantom power.

When turning phantom power on, you must observe the precautions below in order to prevent noise and possible damage to the unit and to external devices.

- Leave this button off if a device that does not support phantom power is connected to the [INPUT] connector.

- Do not connect/disconnect a cable to/from the [INPUT] connector while this button is on.

- Lower the output level to the minimum before turning phantom power on/off.

There is no +48V Active switch. To avoid malfunctions, be sure to set this appropriately for the equipment that is connected.

### 15.9.2. "MY4-AEC" component editor

Right-click the [Slot in] or [Slot Out] component (MTX5-D only), select the "Mini-YGDAI Card" in the context menu and then select the MY4-AEC card "MY4-AEC" component will be displayed.

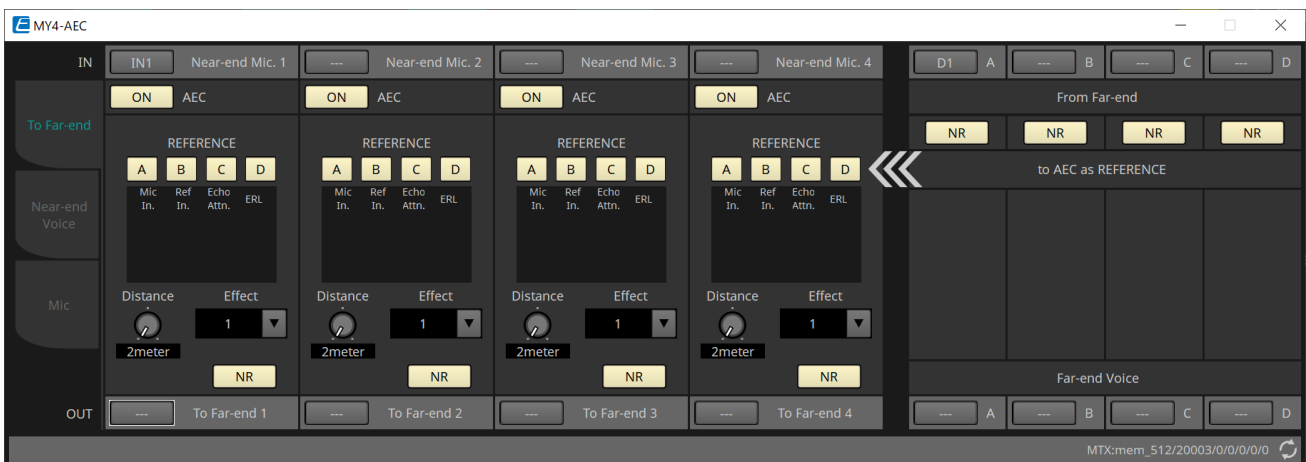
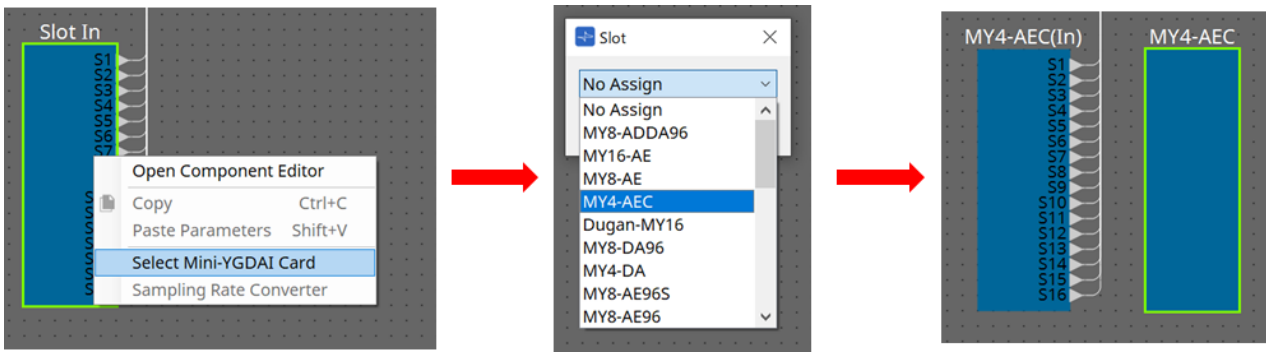

In this screen you can make settings for the signals of the MY4-AEC.

In a teleconferencing system, the local and remote environments are respectively called the Near-end and Far-end.

The MY4-AEC's acoustic echo canceller (AEC) determines the echo component included in the mic input signal by using the signal from the Far-end as the reference signal, and subtracts only the echo component of the Far-end from the mic input signal. This allows clear audio from the Near-end to be transmitted to the other party.

The MY4-AEC's signals can be specified using the following choices and screens.

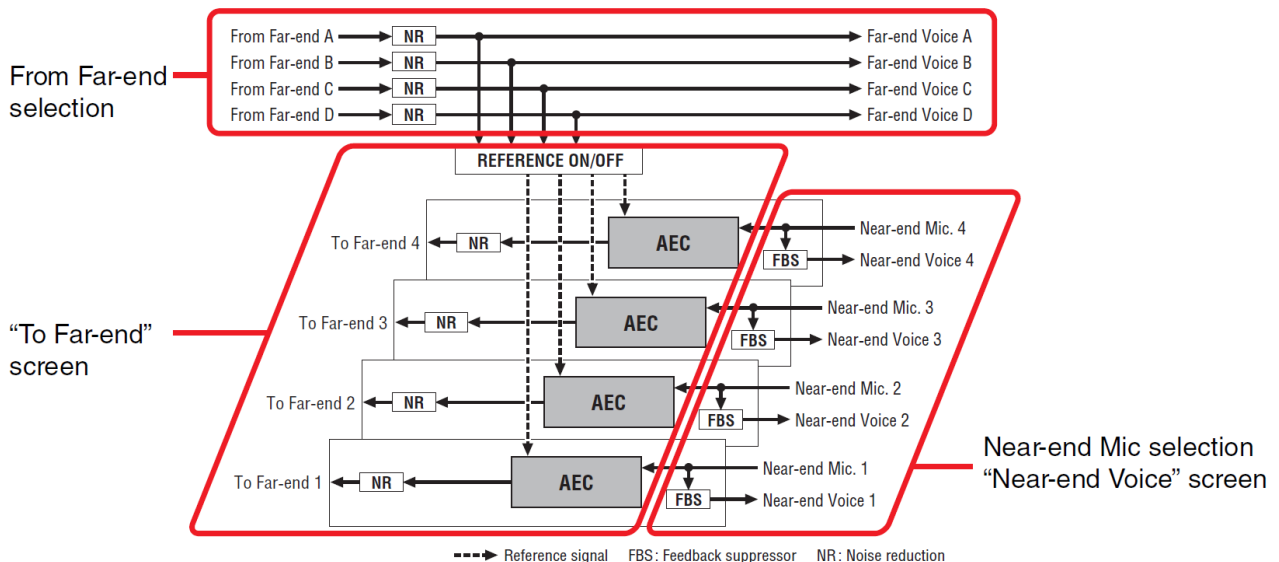

From Far-end	Input signals from the remote location (the other party)
Far-end Voice	Signals from the remote location reproduced by the speakers of the local location (your side)
Near-end Mic.	Input signals from local mics
Near-end Voice	Signals from local mics reproduced by local speakers
To Far-end	Echo-cancelled signals of local mics sent to the remote location

### ■ “To Far-end” screen

In this screen you can make echo-cancel settings for the mics.  
The mic signal after echo-cancellation is output to the remote location.

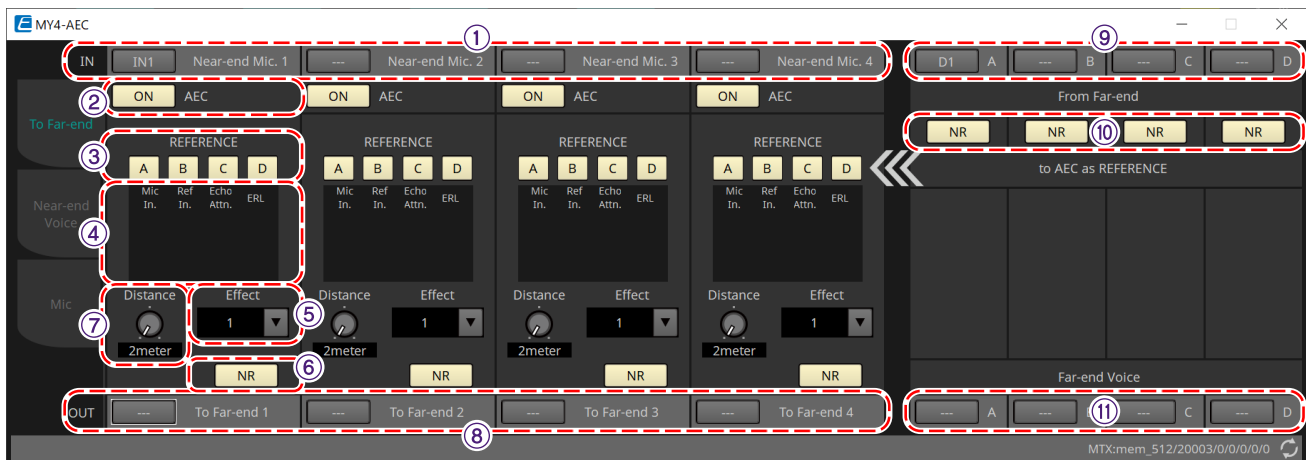

#### ① [Near-end Mic] selection buttons

Here you can select the ports for the local mics (Near-end Mic). When you click a port select button, the “Input Patch” dialog box will appear. The button shows the currently selected port.

#### ② AEC [ON] button

Switches the echo canceller function on/off.

#### ③ REFERENCE [A][B][C][D] button

These buttons select whether the signal specified by the From Far-end selection will be used as the AEC reference signal (REFERENCE).  
If multiple signals are selected, they will be mixed.

#### ④ Meters

- **Mic In. meter**

Indicates the level of the signal that is input from your own mic (Near-end Mic).

- **Ref In. meter**

Indicates the level of the reference signal. The most effective echo cancellation will be obtained with a level at which the yellow indicators light occasionally.

- **Echo Attn. meter**

Indicates the amount of echo cancellation for each channel. Higher levels indicate that the echo canceller is working.

- **ERL meter**

ERL Indicates the ERL (Echo Return Loss = the level of the audio that is output from the speaker and re-input to the mic). Echo cancellation will work most effectively if you adjust the position of the speaker and

---

mic so as to minimize this level.

⑤ **[Effect] list box**

Specifies the amount of echo cancellation. Higher numeric values allow more echoes to be cancelled. However, the audio quality will decrease correspondingly, so you should consider the balance between these factors as you make the adjustment.

⑥ **[NR] button**

These are on/off switches for the noise reduction function which removes steady-state noise such as produced by a projector or air conditioner in the local location. We recommend that you leave these on.

⑦ **[Distance] knob**

This specifies the distance between the installed mic and speaker in units of meters. If multiple mics and speakers are connected, specify the distance between the mic and speaker that are closest to each other. If the distance is 2 m or less, set this to 2.

⑧ **[To Far-end] channel select button**

This button selects the output destination for the audio signals that are output to the remote location (Far-end). Click the button to open the "Output Patch" dialog box.

⑨ **[From Far-end] signal selection buttons**

These open the "Input Patch" dialog box, where you can select the audio signals from the remote location (From Far-end). The button shows the currently selected port or channel.

⑩ **[NR] button**

These are on/off switches for the noise reduction function which removes steady-state noise such as produced by a projector or air conditioner in the remote location. We recommend that you leave these on. The audio signal after noise reduction will be the reference signal (REFERENCE).

⑪ **[Far-end Voice] selection buttons**

These buttons select the output destinations for the audio signals that are output to the speakers of the local location. Click a button to open the "Output Patch" dialog box. The button shows the currently selected channel.



It is assumed that the Far-end Voice will be mixed with the Near-end Mic and output from the speakers. Therefore as seen from the MY4-AEC, the Far-end Voice is output to an input channel of the MTX.



## ■ “Near-end Voice” screen

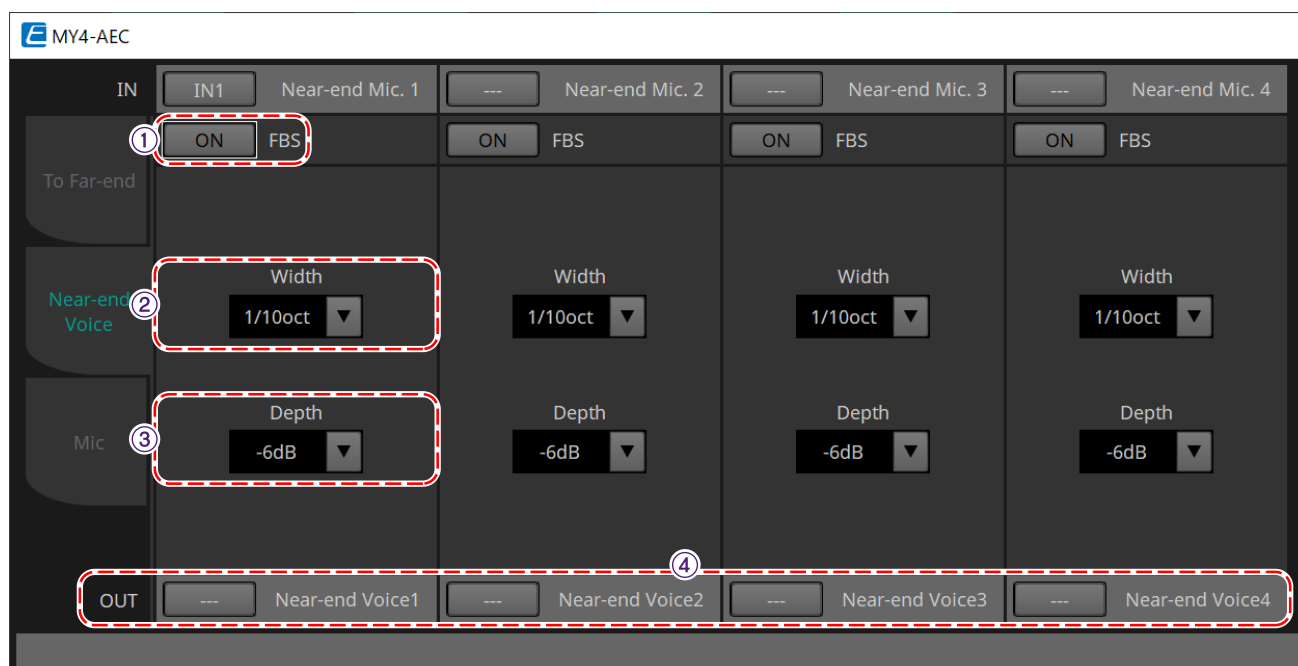

In this screen you can make settings for the FBS (Feed Back Suppressor) that is built into the MY4-AEC.

### ① **FBS [ON] button**

This turns the feedback suppressor function on/off.

The FBS of the MY4-AEC uses the dynamic method of finding the constantly changing feedback points and updating the filter settings accordingly.

This is reset when the MTX5-D is powered-off, and will return to a state in which no notch filter is inserted.

### ② **[Width] list box**

Here you can specify the rejection width of the notch filter that is inserted at the frequency where feedback is detected. Choose a narrower rejection width if the feedback suppressor causes unwanted changes in the character of the sound. A setting of “1/93” is the narrowest setting for the notch filter. However in this case, the feedback suppressor may be less effective.

### ③ **[Depth] list box**

Here you can specify the amount of rejection applied by the notch filter that is inserted at the frequency where feedback is detected. A setting of “-18” produces the strongest suppression of feedback. However in this case, you may notice more change in the character of the sound.

### ④ **[Near-end Voice] channel select button**

This button selects the output destination for the audio signal that is output locally (Near-end Voice). Click the button to open the “Output Patch” dialog box.

## ■ “Mic” screen

When using a mic equipped with a PTT (Push To Talk) switch, a small amount of noise may be heard while the PTT switch is off. If this noise is input to the AEC, the AEC will mistakenly learn the noise, causing an echo when the PTT switch is turned on to resume speaking. In this screen you can make settings and specify the type of mic to prevent this from occurring.

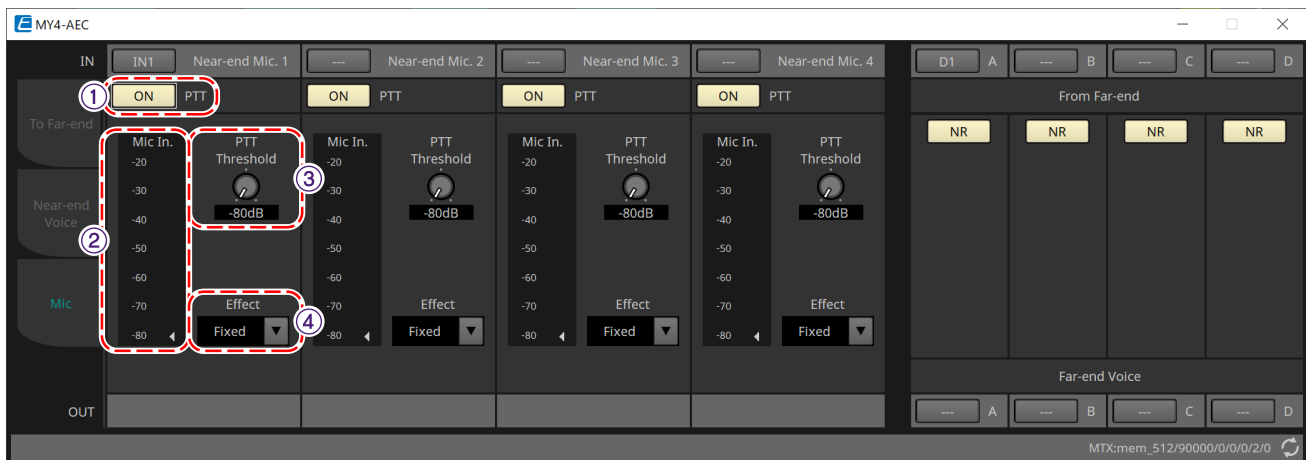

### ① PTT [ON] button

If this is on, and the input level from the local mic (Near-end Mic) falls below the value specified in PTT Threshold, the system will determine that the PTT switch of the local mic has been turned off, and will stop AEC learning. We recommend that you leave this on.

### ② Mic In. meter

This indicates the level of the signal that is input from the local mic (Near-end Mic). This meter will also indicate the level of the noise that occurs when the PTT button of the mic is off.

### ③ [PTT Threshold] knob

This knob sets the reference level for AEC learning. If the PTT [ON] button is on, AEC learning will stop when the input signal to the local mic (Near-end Mic) falls below this level; learning will resume when the input signal exceeds this level.

The Mic In. meter indicates the level of the input signal.

### ④ [Mic. Type] list box

Specify the type of mic that is connected.

Choose “Fixed” for an environment in which the distance between the mic and speaker is fixed, or “Moving” for an environment in which this distance changes, such as when a hand mic is used. Even in an environment in which the distance between the mic and speaker is fixed, choose “Moving” if the echo is obtrusive.

### 15.9.3. "Input CH" component editor

This screen performs input channel signal processing.

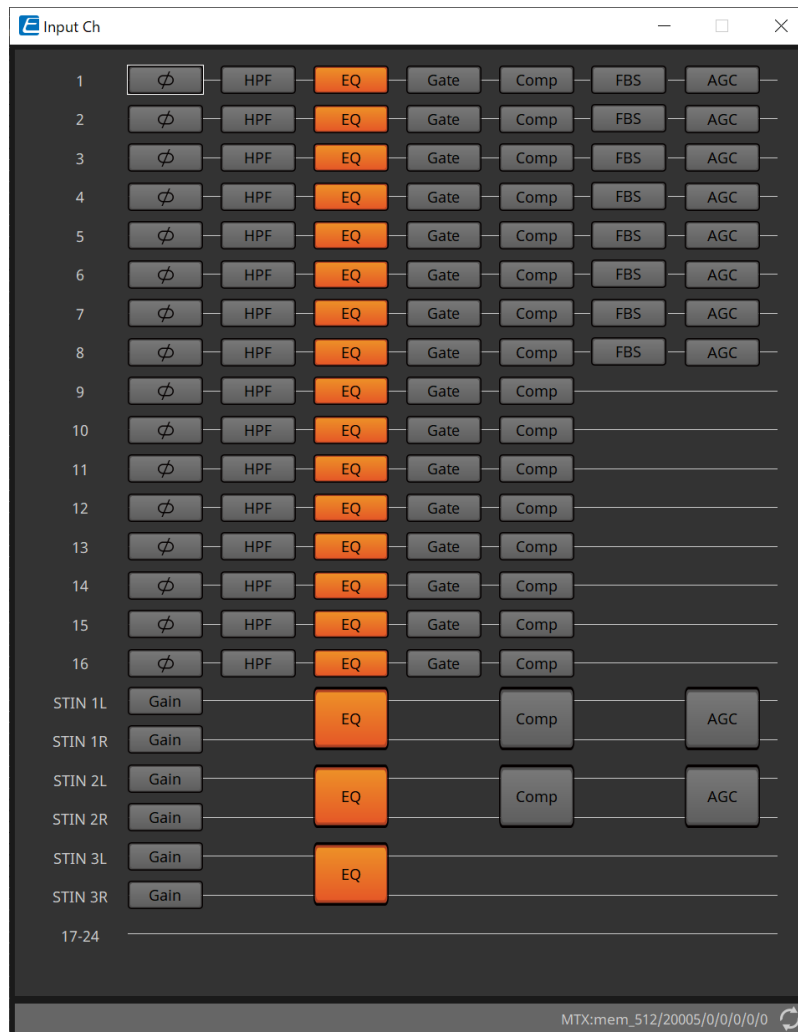

Polarity, "HPF," "EQ," "Gate," "Comp," "FBS," and "AGC" signal processing is performed.

#### •Screen selection



When you click on a button, you will switch to the setting screen.

For details about adjusting each parameter in the component/editor, refer to the ["ProVisionaire Design DME7 Component Guide"](#).

#### • Operations common to the "INPUT" screens



Channel settings can be copied to other channels. When you right-click inside an area, a context menu will be displayed.

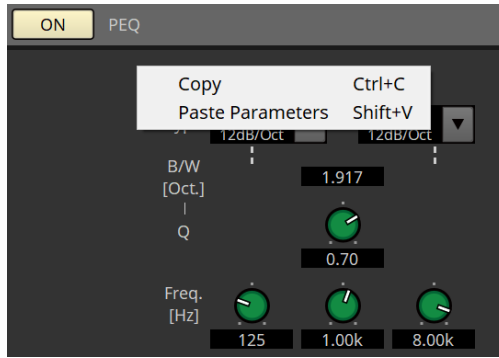

### 15.9.4. "Insert" component editor

This button displays a screen where you can edit the insert on/off setting eight channels at a time. If this is on, the audio signal will be sent from POST ON to the Mini-YGDAI card installed in [SLOT].

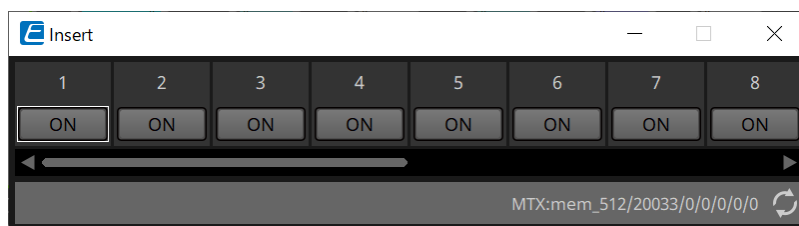

If no Mini-YGDAI card is installed, or if the installed Mini-YGDAI card does not support insertion, there will be no audio output if this is turned on.

### 15.9.5. "Zone" component editor

In this screen you can specify settings for the PGM1, and how input signal priority will control output signals.

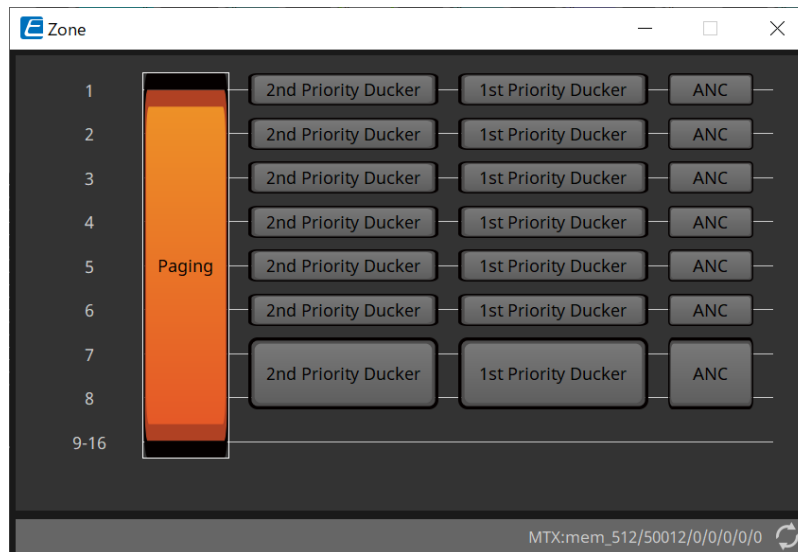

When you click on a button, you will switch to the setting screen.

- **[Paging]**  
Displays the "Paging" component editor for configuring the PGM1 paging station microphone.
- **[2nd Priority Ducker]**  
**[1st Priority Ducker]**  
Displays the "Priority Ducker" component editor.
- **[ANC]**  
Displays the "Ambient Noise Compensator" component editor.

For more information on Ducker and ANC, please refer to the ["ProVisionaire Design DME7 Component Guide"](#).

## ■ "Paging" component editor (MTX5-D only)

In this screen you can make settings for the PGM1 paging station microphone.

Paging refers to the function of broadcasting an announcement.

For the workflow of making settings, refer to the ["Workflow for paging settings."](#)

The SD messages referred to here are standard-format announcements saved on the SD card of the MTX.

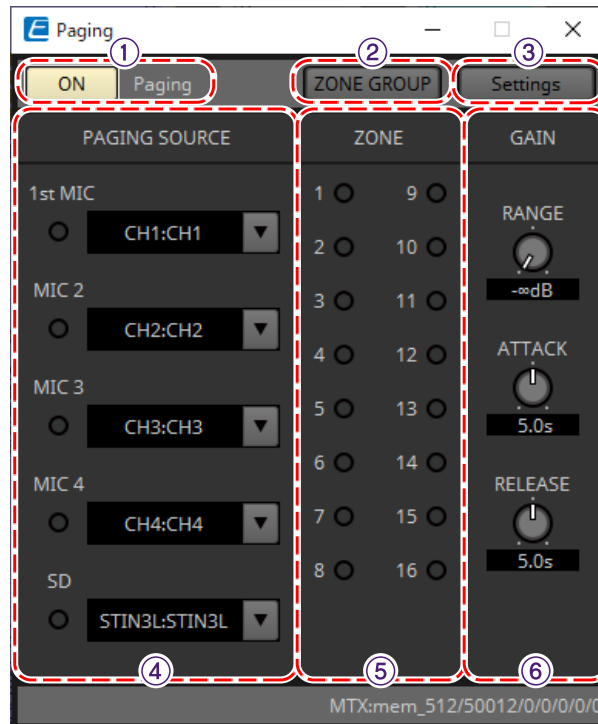

### ① Paging [ON] button

Turns the paging function on/off.

### ② [ZONE GROUP] button

The ["ZONE GROUP" editor](#) opens when this is clicked.

### ③ [Settings] button

The ["PGM1/PGX1" editor](#) opens when this is clicked.

### ④ PAGING SOURCE settings area

- **Indicator**

This is lit if there is a currently-broadcasting PGM1 or SD.

- **Channel list box**

Selects the paging source. Select the input channel to which a PGM1 or SD is connected. Specify 1st Mic for the input channel of the PGM1 that is specified as 1st Priority.

### ⑤ ZONE area

- **Indicator**

This is lit if there is a zone that is currently broadcasting using a PGM1 or SD message.

### ⑥ GAIN setting area

Each knob resets to the default value if you click it while holding down the < Alt > key.

In this area, you can make settings related to the line shown in green in the flow depicted below.

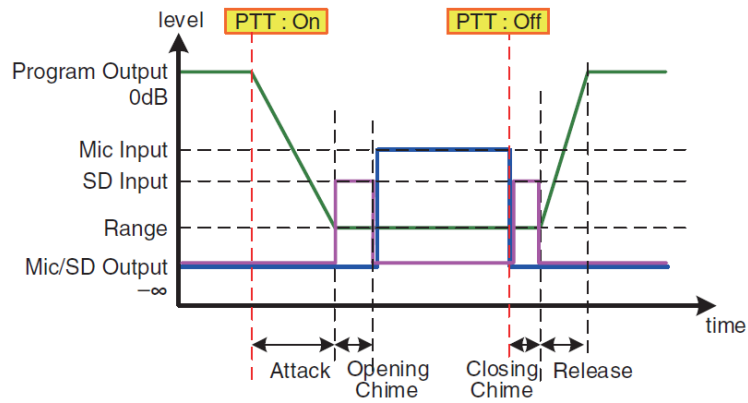

- **[RANGE] knob**  
Specifies the Program value while the chime is sounding or while the PGM1 is broadcasting.
- **[ATTACK] knob**  
Specifies the time from when the PGM1's PTT turns on until the program decreases to the RANGE value.
- **[RELEASE] knob**  
Specifies the time from when the broadcast or the closing chime finishes playing until the program returns to its original level.

#### ■ "ZONE GROUP" editor

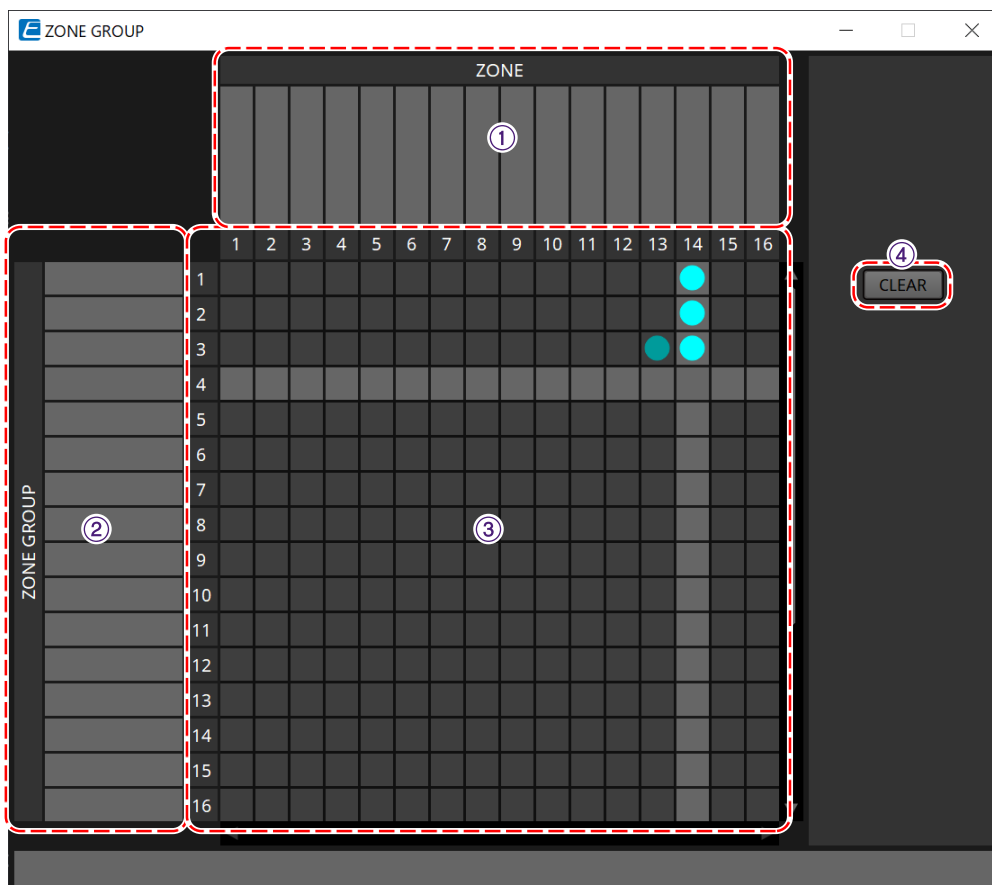

- ① **Zone name**  
Indicates the zone name.
- ② **Group name**  
Indicates the group name.



### ③ ZONE GROUP matrix

Specify a zone group if you want a single zone/message select button of a PGM1/PGX1 to broadcast to multiple zones. Click on the matrix to select Zones to add to the Zone Group. You can specify up to 24 zone groups.

### ④ [CLEAR] button

Clears the ZONE GROUP that had been set.

### ■ "PGM1/PGX1" editor

Here you can make assignments for the zone/message select buttons of the PGM1 and PGX1, and make settings for the PTT button.

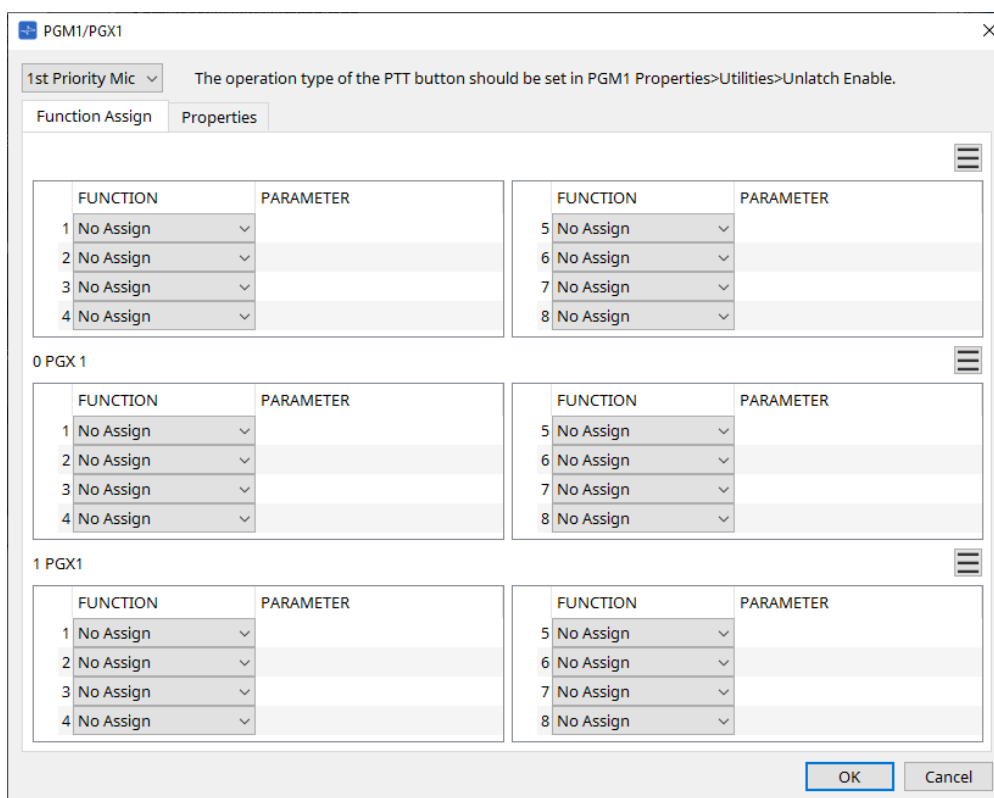

#### • PGM1 select list box

Select the PGM1 unit for which you want to make settings.



PGM1/PGX1 settings can be made even if PGM1 is not connected to the MTX itself. Please connect PGM1/PGX1 properly during operation.

#### • [Function Assign] tab

Here you can assign functions to the zone/message select buttons of the PGM1 or PGX1. "FUNCTION" provides the following choices.

- **[No Assign]**  
No function is assigned to the button.
- **[Zone]**  
Selects/de-selects the zone to broadcast.  
When selected, the zone/message indicator is lit.
- **[Zone Group]**  
Selects/de-selects multiple zones to broadcast in a single operation.  
Set the zone group using the ["ZONE GROUP" editor](#).  
The zone/message indicator is lit when broadcast is possible to all zones that are registered in the

group.

- **[SD Message]**

Selects the file of the SD card to play.

- **[All Zone Off]**

De-selects all zones/zone groups.

This does not affect the selection status for the zones/zone groups of other PGM1/PGX1 units.

- **[All Zone On/Off]**

Selects/de-selects all zones/zone groups.

This does not affect the selection status for the zones/zone groups of other PGM1/PGX1 units.

The zone/message indicator is lit when broadcast is possible to all zones/zone groups.

- **Menu button (☰)**

Click the menu button to execute the following functions.

- **[Copy]**

Copies the FUNCTION and PARAMETER settings of the corresponding device to the copy buffer.

- **[Paste]**

Pastes the FUNCTION and PARAMETER settings from the copy buffer, overwriting them onto the corresponding device.

- **[Clear]**

Initializes the FUNCTION and PARAMETER settings of the corresponding device.

- **[Properties] tab**

Here you can make settings for the operation of the PCM1.

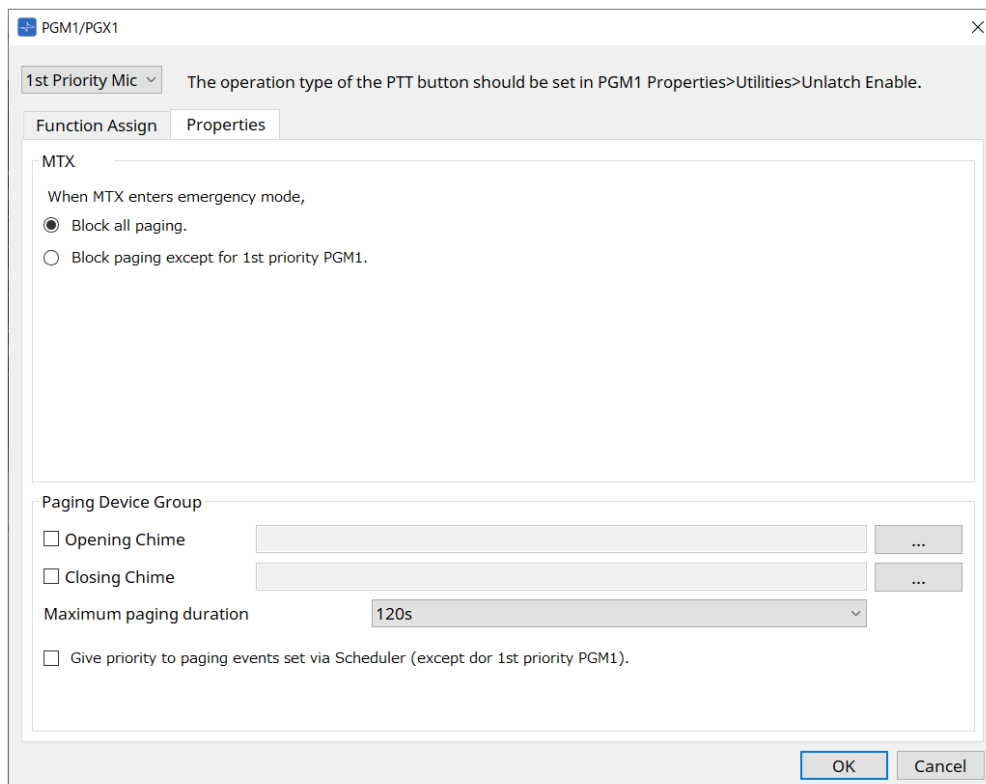

- **MTX**

- **[Stop all broadcast.] option button**

If this is selected, paging broadcast including the scheduler will be stopped when the MTX is in emergency mode.

- **[Stop broadcast except for 1st Priority PGM1] option button**  
If this is selected, paging broadcast will be possible only for the 1st Priority PGM1 when the MTX is in emergency mode.
- **Paging Device Group**
  - **[Opening Chime]/[Closing Chime] check boxes**  
If these check boxes are selected, you can make settings for the opening chime and/ or closing chime. Click the button at right to specify the chime file that will play. This setting is shared by the PGM1 (Paging Device Group) units that are connected to the same MTX.
  - **[Maximum paging duration] list box**  
Selects the time after PTT is turned on until it is automatically turned off. If a message is being played back, it will not turn off even if the specified time is exceeded. This setting is shared by the PGM1 units that are connected to the same MTX.
  - **[The scheduler's paging events are broadcast with higher priority than PGM1. Paging events have a lower priority than 1st Priority PGM1.] check box**  
If this check box is selected, the priority order will be "1st Priority PGM1 > events > normal PGM1."  
If this check box is cleared, the priority order will be "1st Priority PGM1 > normal PGM1 > events."
- **[OK] button**  
Saves the settings and closes the dialog box.
- **[Cancel] button**  
Discards the settings and closes the dialog box.

#### ■ "PRIORITY DUCKER" component editor

You can make ducker settings.

The ducker is a function that temporarily reduces the input from one channel when an audio signal is input to another specified input channel, allowing the audio from the specified channel to be heard clearly. The priority order is as follows: "PRIORITY SOURCE" of the "1st PRIORITY" > "PRIORITY SOURCE" of the "2nd PRIORITY" > MATRIX Out signal.

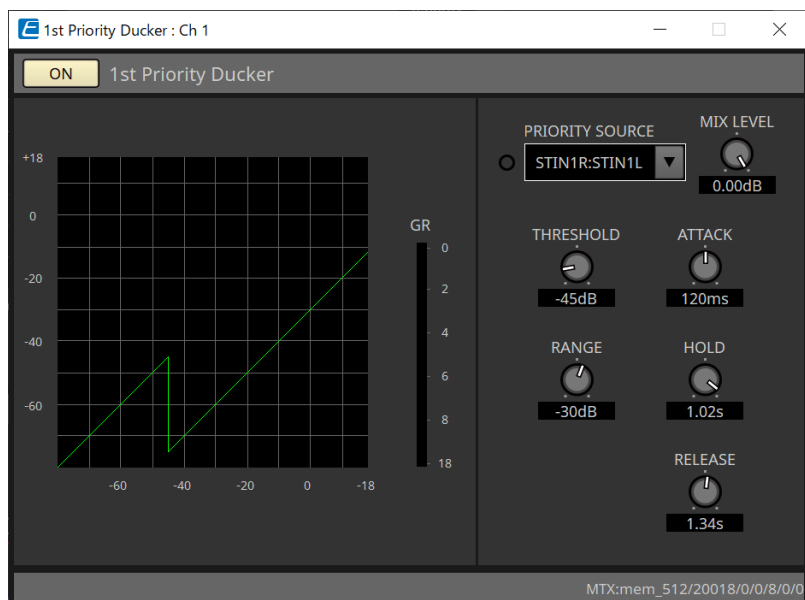

- **[PRIORITY SOURCE] list**  
Selects the input signal for the ducker.  
Select [ANC Bus] if you want the mixed signal to be the high-priority audio. The mix of audio signals to the ANC bus can be created in the "Matrix Mixer" component editor.

For details about other parameters, refer to the ["ProVisionaire Design DME7 Component Guide"](#) .

### ■ "Ambient Noise Compensator" component editor

In this editor you can make settings for the "Ambient Noise Compensator" (subsequently called "ANC"). ANC is a function that boosts or attenuates the output signal from the MTX according to the level that is being input via an ambient noise detection mic. The ANC function provided by the MTX is a gap-type ANC that detects silent intervals such as between songs, detects the noise level during those intervals, and varies the level accordingly.

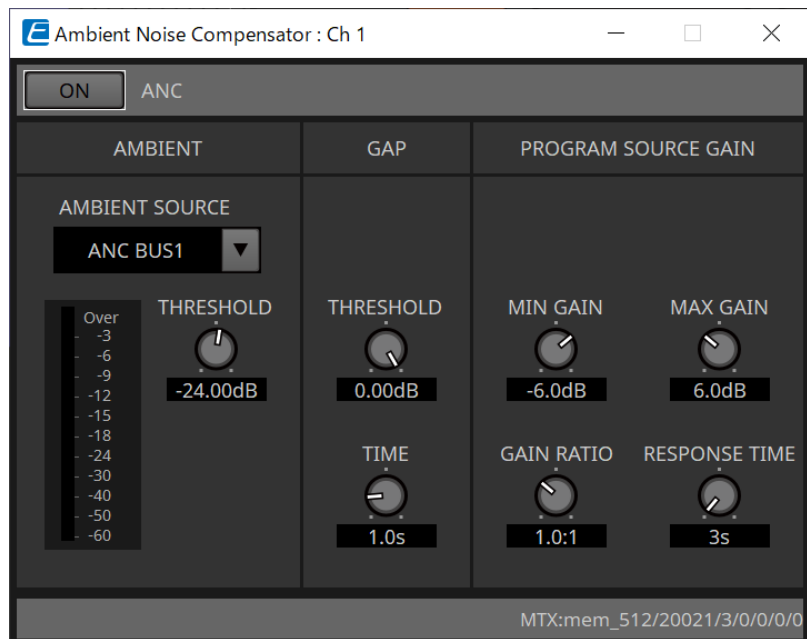

For details about parameters, refer to the ["ProVisionaire Design DME7 Component Guide"](#) .

## 15.9.6. "Output CH" component editor

This screen performs output channel signal processing.

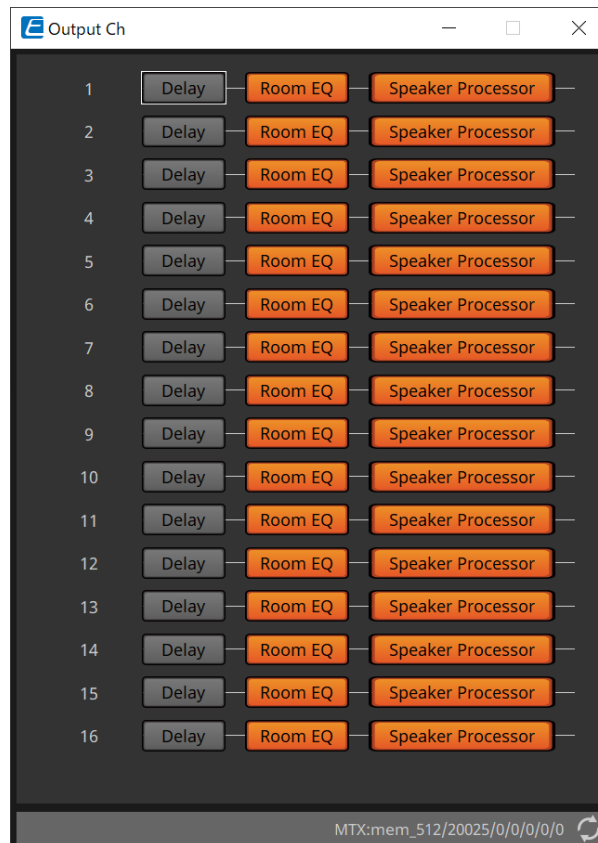

This performs the "Delay," Room EQ," and "Speaker Processor" signal processing.

### • Screen selection

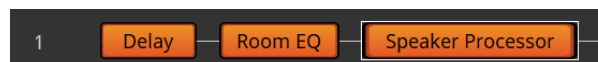

When you click on a button, you will switch to the setting screen.

For details about adjusting each parameter in the component editor, refer to the ["ProVisionaire Design DME7 Component Guide"](#).

### • Operations common to the "OUTPUT" screens



You can copy channel settings to other channels.  
When you right-click within the area, context menu will appear.



## 15.9.7. "Pilot Tone" component editor

You can make settings to specify whether a pilot tone is output from digital output. When the PILOT TONE [ON] button is turned on, the pilot tone is set to the YDIF or Dante output channel that has been assigned to pilot tone output.

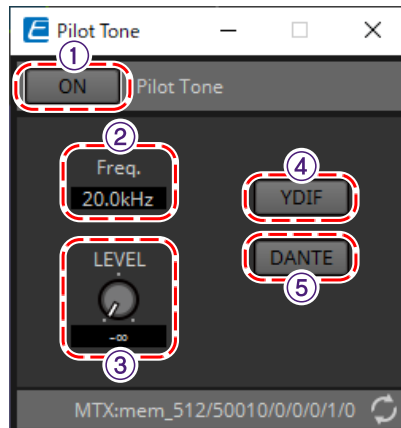

### ① PILOT TONE [ON] button

Sets the ON/OFF status of the pilot tone function. If OFF, the pilot tone will not be sent even if the "YDIF" or "DANTE" is set to ON.

### ② Freq.

Indicates the center frequency of the pilot tone. This is fixed at 20 kHz.

### ③ [LEVEL] knob

Specifies the level of the pilot tone.

### ④ YDIF button

The screen to set the pilot tone output to YDIF opens when this is clicked.

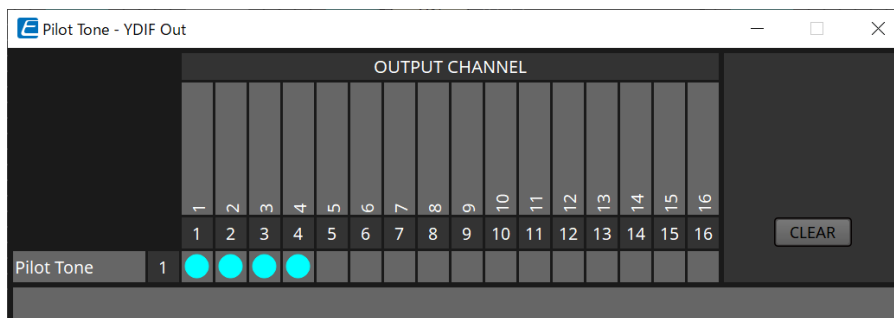

### ⑤ DANTE button (MTX5-D only)

The screen to set the pilot tone output to DANTE opens when this is clicked.

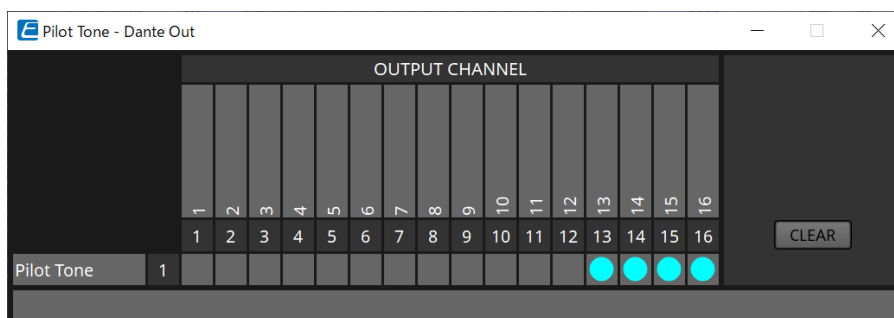

## 15.9.8. "Analog Out" component editor

Here you can make settings for the [OUTPUT] jack outputs, and view the levels of the audio signals that are being output.

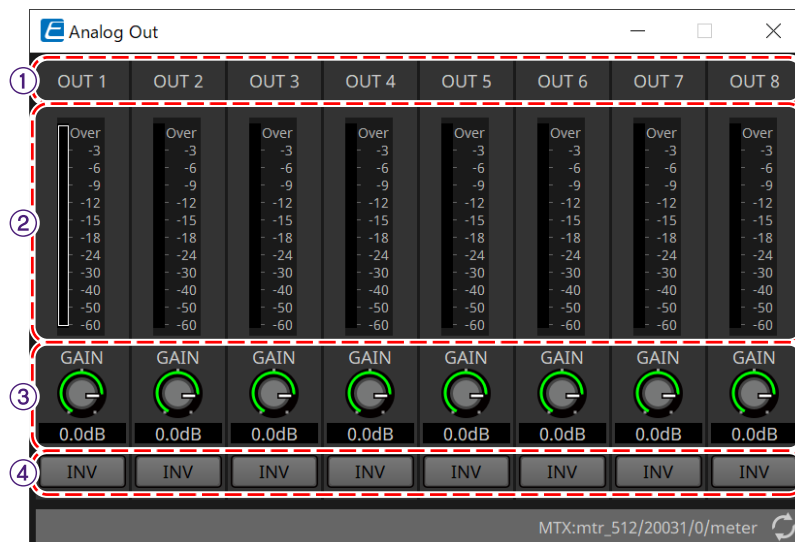

① **Channel index**

Indicates the analog output jack number.

② **Level meter**

Indicates the analog output level.

③ **[GAIN] knob**

Adjusts the output gain.

④ **[INV] button**

Switches the polarity of the output signal.



### 15.9.9. "Slot Out" component editor

Here you can make settings for the Mini-YGDAI card outputs, and view the levels of the audio signals that are being output.

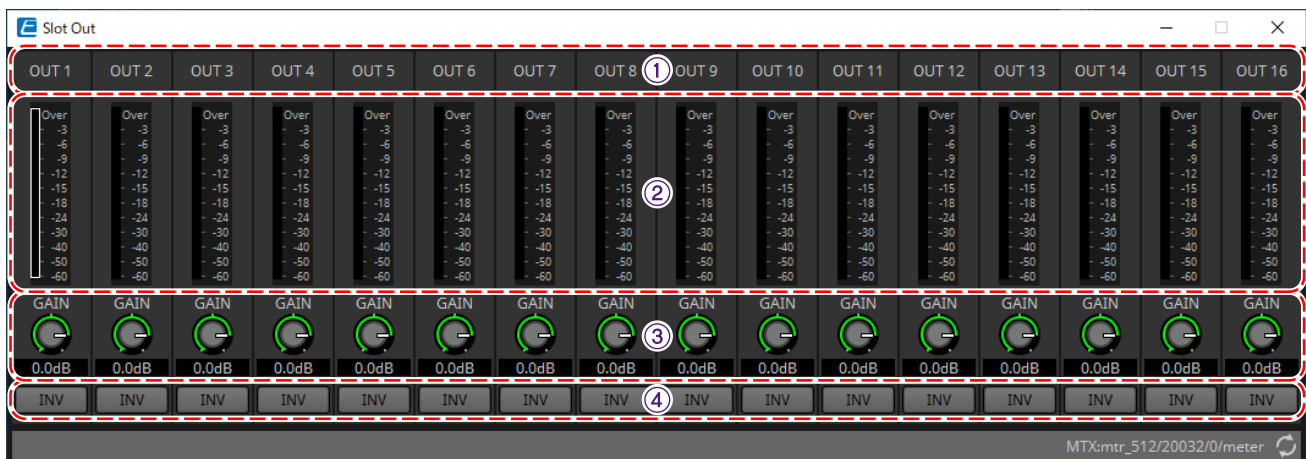

① **Channel index**

Indicates the output jack number.

② **Level meter**

Indicates the output level.

③ **[GAIN] knob**

Adjusts the output gain.

④ **[INV] button**

Switches the polarity of the output signal.

## 15.9.10. "DCA Groups"/"Mute Groups" component editor

This is a component editor to control the level and mute for multiple channels at the same time.



These component editors can register 8 groups for the DCA group and mute group for the input channels and 8 groups for the DCA group and mute group for the ZONE output.

In the DCA groups, the input level or output level of multiple channels can be controlled simultaneously with a single knob.

The mute group can be used to turn multiple channels ON or OFF simultaneously.

- **"Input DCA Groups" component**

Displays the editor to set the DCA group for the input channel.

- **"Input Mute Groups" component**

Displays the editor to set the mute group for the input channel.

- **"Zone DCA Groups" component**

Displays the editor to set the DCA group for the ZONE output.

- **"Zone Mute Groups" component**

Displays the editor to set the mute group for the ZONE output.

- **"Input DCA Groups" component/"Zone DCA Groups" component**

A screen for the "Input DCA Groups" component is shown below, but the "Zone DCA Groups" component screen has the same layout.

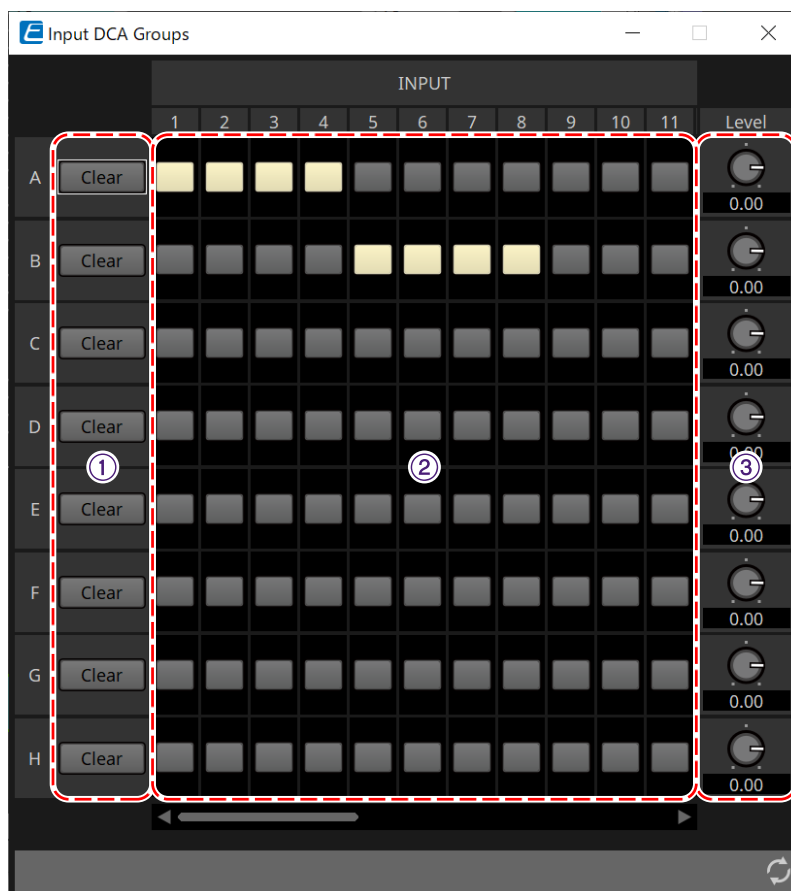

① **[Clear] button**

This button clears all channels assigned to the corresponding group.

## ② Assignment channel matrix

This matrix lets you assign channels to DCA groups.

The group names are shown on the vertical axis, and the names of the channels that can be assigned are shown on the horizontal axis. Click an intersection to assign a channel to a group.

## ③ [Level] knob

Adjust the level of each DCA group.

## ■ "Input Mute Groups" component/"Zone Mute Groups" component

A screen for the "Input Mute Groups" component is shown below, but the "Zone Mute Groups" component screen has the same layout.

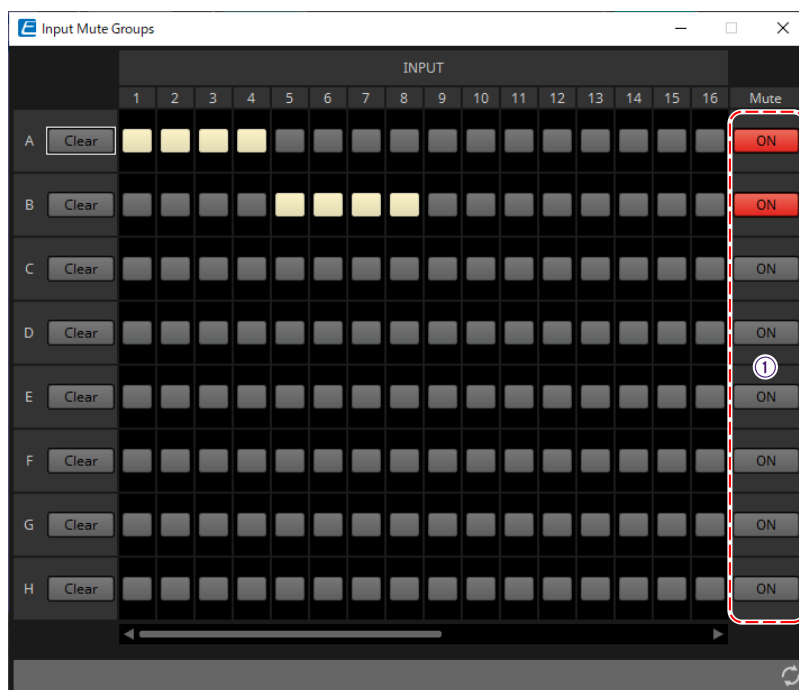

## ① [Mute] group main button

These buttons turn each mute group on/off.

## 15.10. Workflow for paging settings

Up to four PGM1 units can be connected to one MTX5-D unit. One PGM1 becomes the 1st Priority Mic and can be broadcast with priority over other PGM1s.

Here's an example of connecting four PGM1 units to the MTX5-D.

The mic that has higher broadcast priority than the other mics is called the 1st Priority Mic (Unit ID = 60). Patch its output to the MTX5-D's Dante Input 1Ch.

Patch Mic2-4 (Unit ID=61-63) to Dante Input 2Ch-4Ch of MTX5-D similarly.

Configure Dante settings with Dante Controller.

1. In the "Project" sheet, place the MTX5-D.
2. Select the MTX5-D placed on the "Project" sheet.

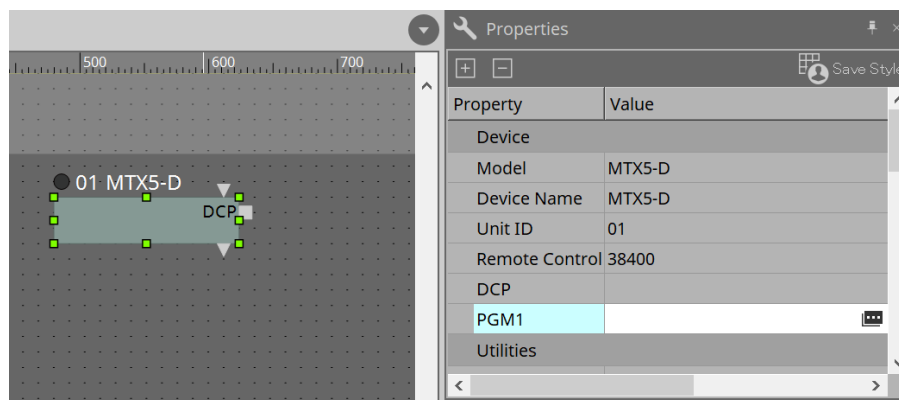

To display the "PGM1" dialog, first click the „Value“ column of the "PGM1" in the "Property" area, then click on .

3. Specify the Unit ID (60 to 63) of PGM1.

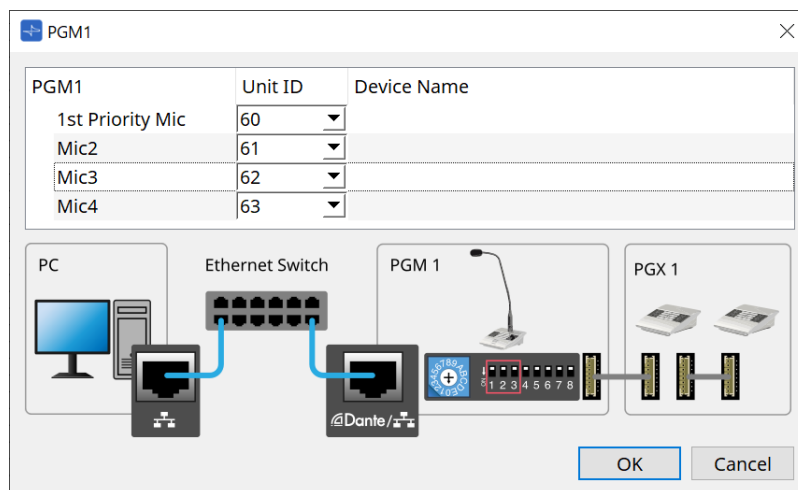

#### 4. Open the MTX5-D's "Input Patch" component editor.

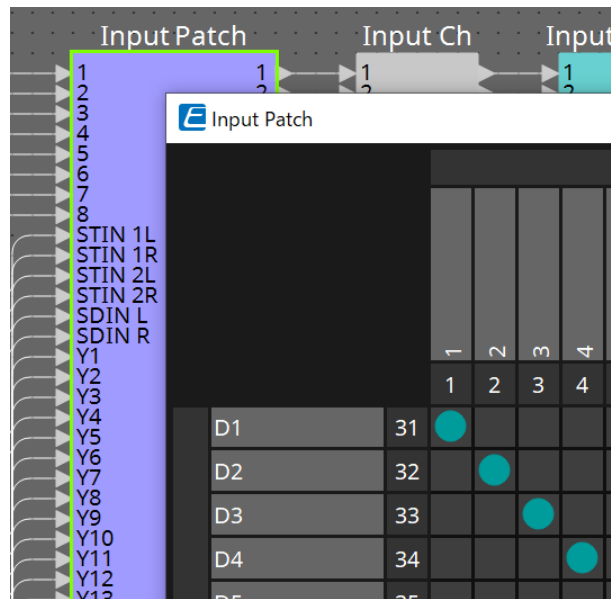

Assign D1 to Input Channel 1.

Assign D2-D4 to input channels 2-4 in the same way.

#### 5. Open the MTX5-D's "ZONE" component -> "Paging" component editor.

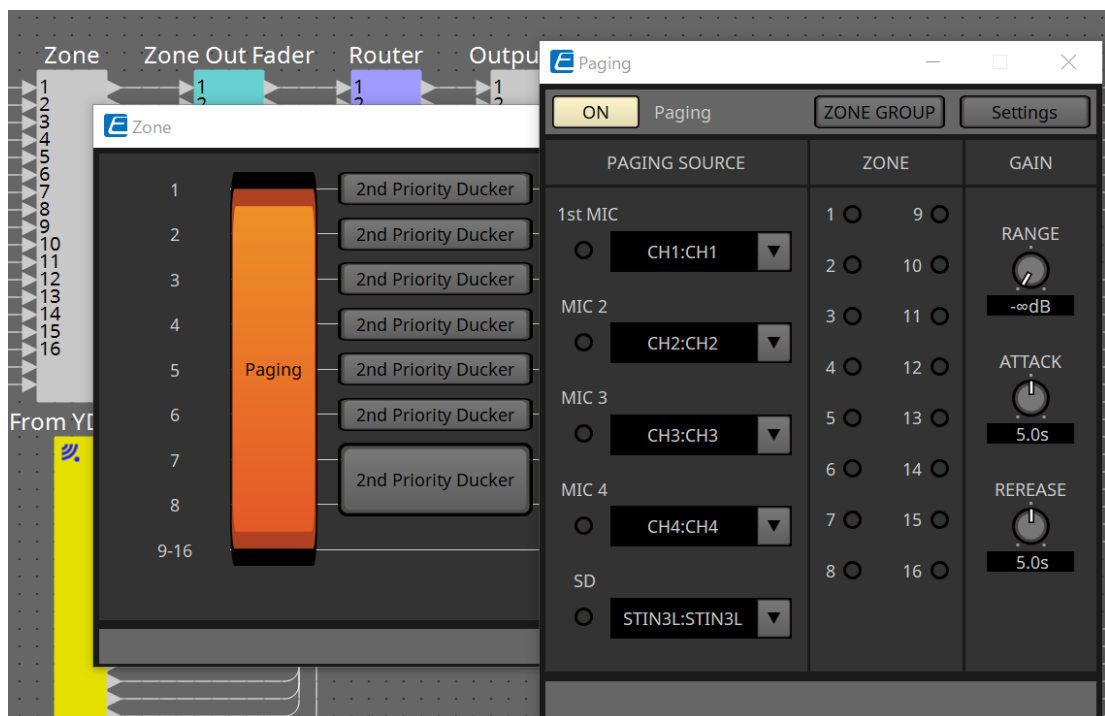

Select "CH1:CH1" for 1st Mic of PAGING SOURCE.

Select others as well.

#### 6. Assign functions to buttons in the "PGM1/PGX1" editor that appears when you click the [Settings] button.

As necessary, set the ZONE GROUP in the "ZONE GROUP" editor that appears when you click the [ZONE GROUP] button.

For the "PGM1/PGX1" editor and "ZONE GROUP" editor, refer to the respective explanations.



The initial setting of PGM1 Properties --> Utilities --> Unlatch Enable is "OFF".  
The following procedure is required to change the Unlatch Enable setting and reflect it in PGM1.

1. Install Bonjour Print Service on your computer so that ProVisionaire Design can find PGM1.
2. Place PGM1 on the "Project" sheet. Specify the Unit ID set in "3" when placing.

The settings will be reflected when synchronizing.

## 16. MTX I/O Expanders: EXi8 / EXo8

### 16.1. Overview

These are the MTX series input expander AD converter (EXi8) and the output expander DA converter (EXo8). The EXi8 converts 8-channel mic/line signals to YDIF and sends them digitally to MTX series devices. The EXo8 receives audio from MTX series devices in YDIF format and outputs an 8-channel analog signal.

### 16.2. "Project" sheet

This is the sheet on which devices are placed. When placing devices, the Settings screen shown below is displayed.

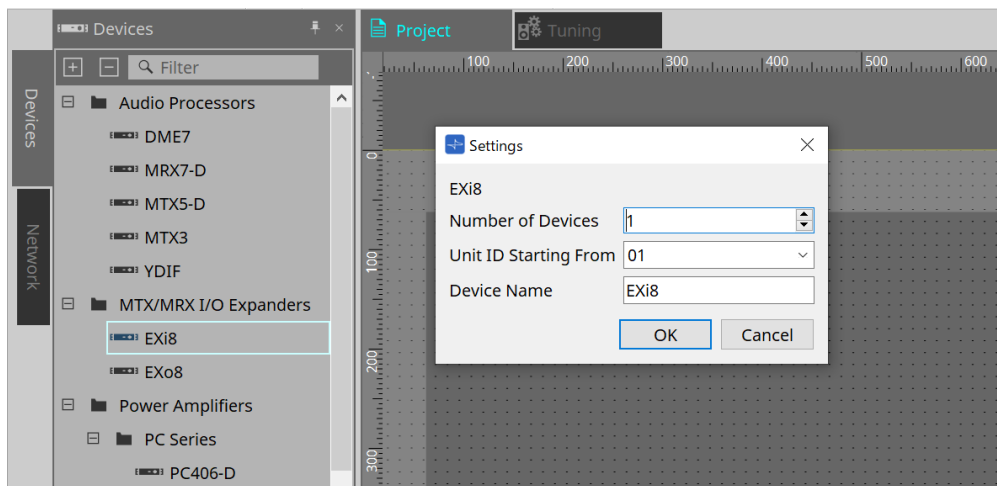

- **Number of Devices**  
Selects the number of EXi8 or EXo8 units placed on the sheet.
- **Unit ID Starting From**  
You can select the starting number for the device Unit IDs.
- **Device Name**  
The device name can be displayed and edited.



By using Devices area > YDIF, the YDIF connection method can be displayed.

## 16.3. Editor

Double clicking the EXi8 on the Project sheet will open the [EXi8] editor.

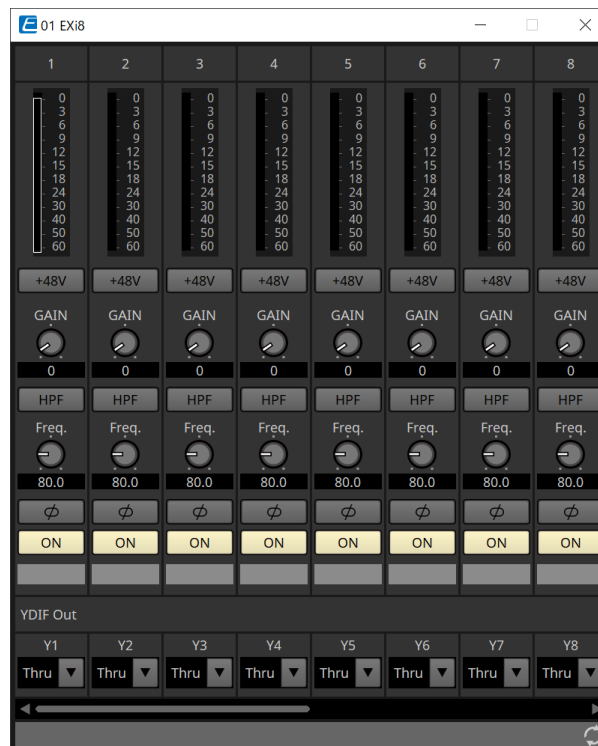

- **[+48V] button**  
Switches the HA phantom power supply (+48 V) ON and OFF.

### NOTE

If the phantom power supply is not required, turn this button OFF.

If the phantom power supply is turned ON, please note the following to prevent damage or noise to the main unit/external devices.

- When connecting a device that is not phantom power compatible to an [INPUT] terminal, turn the button OFF.
  - Do not disconnect cables from the [INPUT] terminal while the power button is still ON.
  - Set the output level to its lowest level when turning the phantom power supply off or on.
- There is no ACTIVE switch. Use settings that match the connected equipment to avoid damage.

- **HA analog gain**  
Adjusts the HA (headphone amp) analog gain.
- **[HPF] button/cutoff frequency**  
Switches the HPF (high-pass filter) ON and OFF.  
Sets the HPF cutoff frequency.
- **[φ] button**  
Switches the input signal phase.
- **[ON] button**  
Switches the input channel ON and OFF.
- **YDIF Out**  
Select the channel to output to YDIF.  
If you select Thru, the signal that is input from YDIF In will be output as-is.



Double clicking the EXo8 on the Project sheet will open the [EXo8] editor.

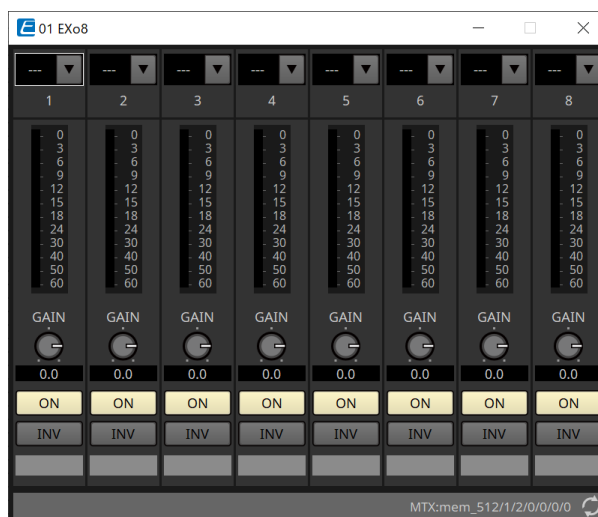

- **YDIF In**  
Assigns the signal that is input from YDIF In to a channel.
- **Gain**  
Adjusts the output gain.
- **[ON] button**  
Switches the output channel ON and OFF.
- **INV button**  
Switches the output signal polarity.

# 17. Power Amplifiers: PC-series

## 17.1. Overview

By combining the powerful 20×8 input matrix functions of the PC-D/DI series amplifiers with Dante I/O, the versatility of any system can be dramatically increased.

Not only can the PC-D/DI's input matrix function be an auxiliary matrix that expands the entire system, but by allowing direct audio signal input from other analog devices or Dante-equipped devices even in systems without additional mixers or DSPs, even more flexible routing becomes possible.

## 17.2. "Project" sheet

This is the sheet on which devices are placed. When placing devices, the Settings screen shown below is displayed.

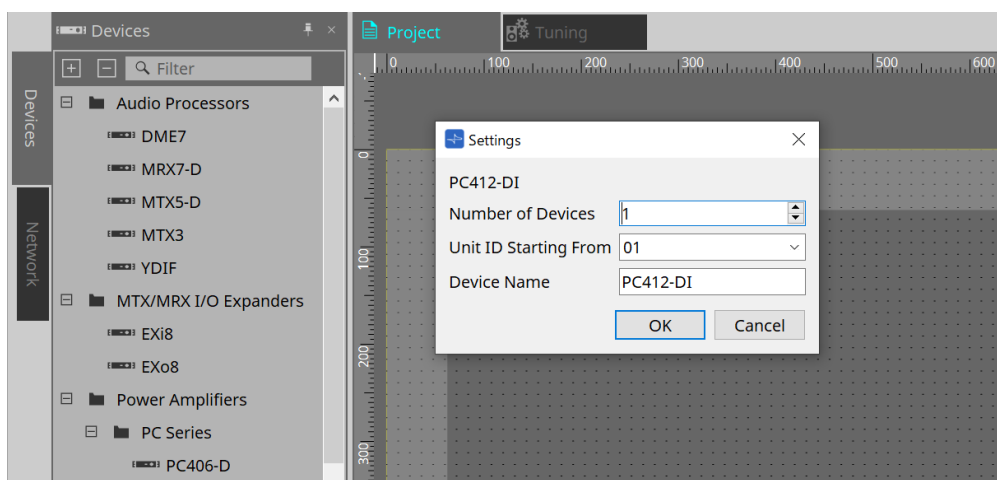

- **Number of Devices**  
Selects the number of PC series units placed on the sheet.
- **Unit ID Starting From**  
You can select the starting number for the device Unit IDs.
- **Device Name**  
The device name can be displayed and edited.

## 17.2.1. PC-D and speaker connections

If you drag and drop speakers from the Devices area, any speaker can be added to the Project sheet.

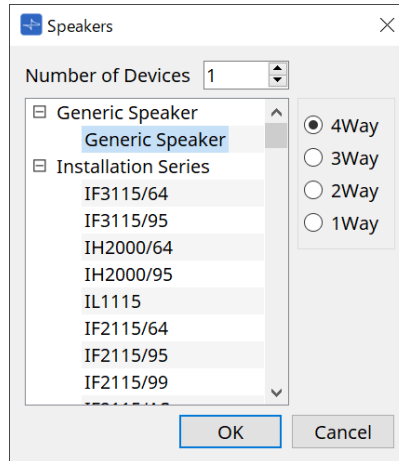

When you connect an amp and speaker, and double click on the speaker, the Speaker Editor is displayed.

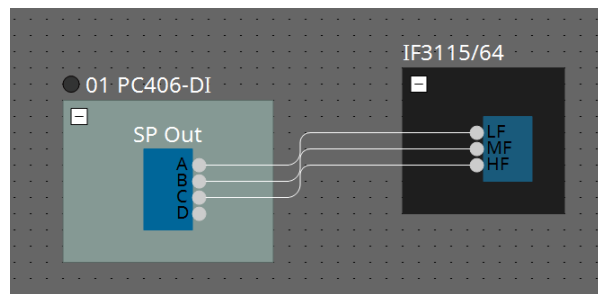

The Speaker Editor allows you to control the parameters of the power amplifier from which you are connecting. For details, refer to "Speaker Editor / Multi Speaker Editor."

## 17.2.2. "Properties" area

Refer to the PC series owner's manual for information about device settings.

### 17.2.3. Speaker Editor / Multiple Speaker Editor

When a speaker is connected to a PC-series device via a wire, the parameters of the PC-series device's speaker processor are shown for each individual speaker.

When you double-click a speaker or right-click and choose [Open Speaker Editor] from the context menu, the Speaker Editor opens.

When multiple speakers are selected, you can right-click and choose [Open Multiple Speaker Editor] from the context menu to open the Multiple Speaker Editor.

This is convenient in the following situations.

- When speakers are connected to multiple PC-series devices, and you want to view each of these speaker processors in a single step.
- When you want to view the superimposed response curves of the Main and Sub speakers. (Multiple Speaker Editor)

For details on the parameters, refer to "Speaker Processor" component editor of the ["ProVisionaire Design DME7 Component Guide"](#).

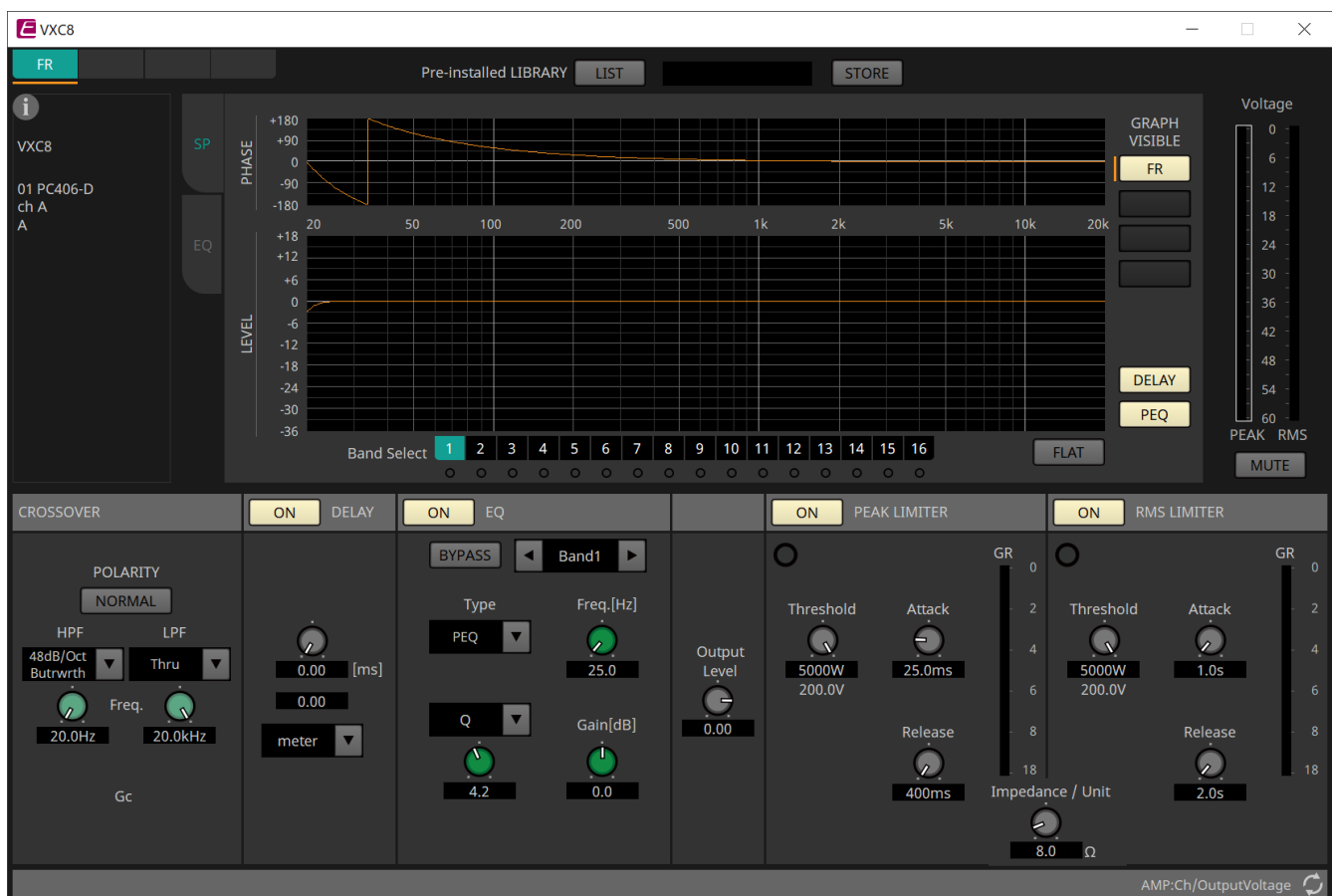

## 17.3. "Tuning" sheet

For the sheet details, please refer to the ["Tuning" sheet](#).

### 17.3.1. Link group editor

This appears when you double-click a link group on the "Tuning" sheet in which a channel of a PC-series unit is registered, or when you right-click and choose [Open Link Group Editor].

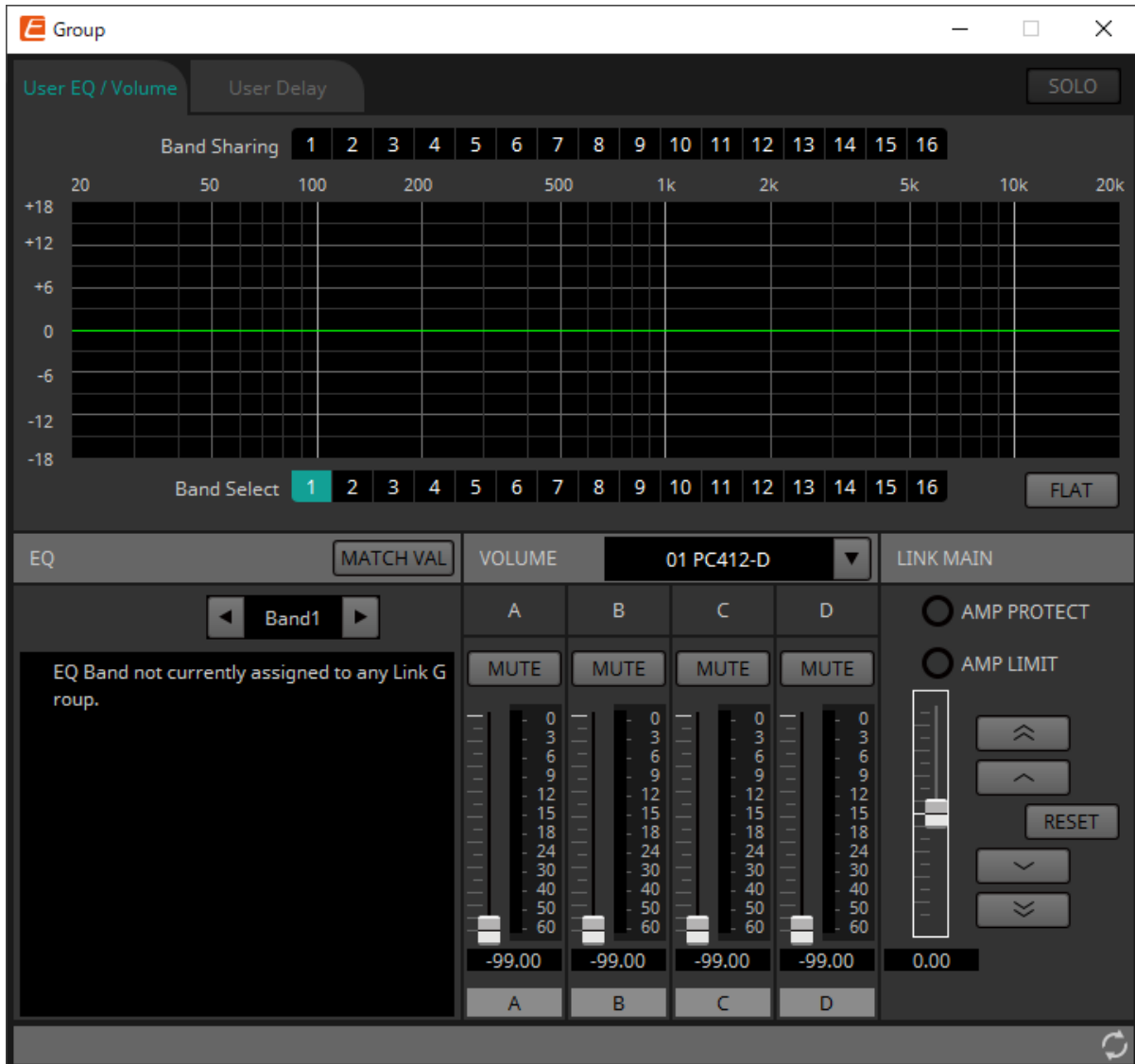

- **[SOLO] button**

When online, this is enabled if the tool bar's [Solo Mode] button is on.

If this is turned on, audio is output only from the channels that are registered to this link group, which is convenient when making final adjustments to the EQ, volume, and delay.

### 17.3.2. [User EQ/Volume] tab

Here you can make collective adjustments to the User EQ and volume of the channels registered in the group.

Use the Master fader to control the volume.

The "Volume" master fader collectively applies a relative adjustment to the volume of the channels registered in the group.

For details, refer to ["User EQ/User Delay" component editor](#).

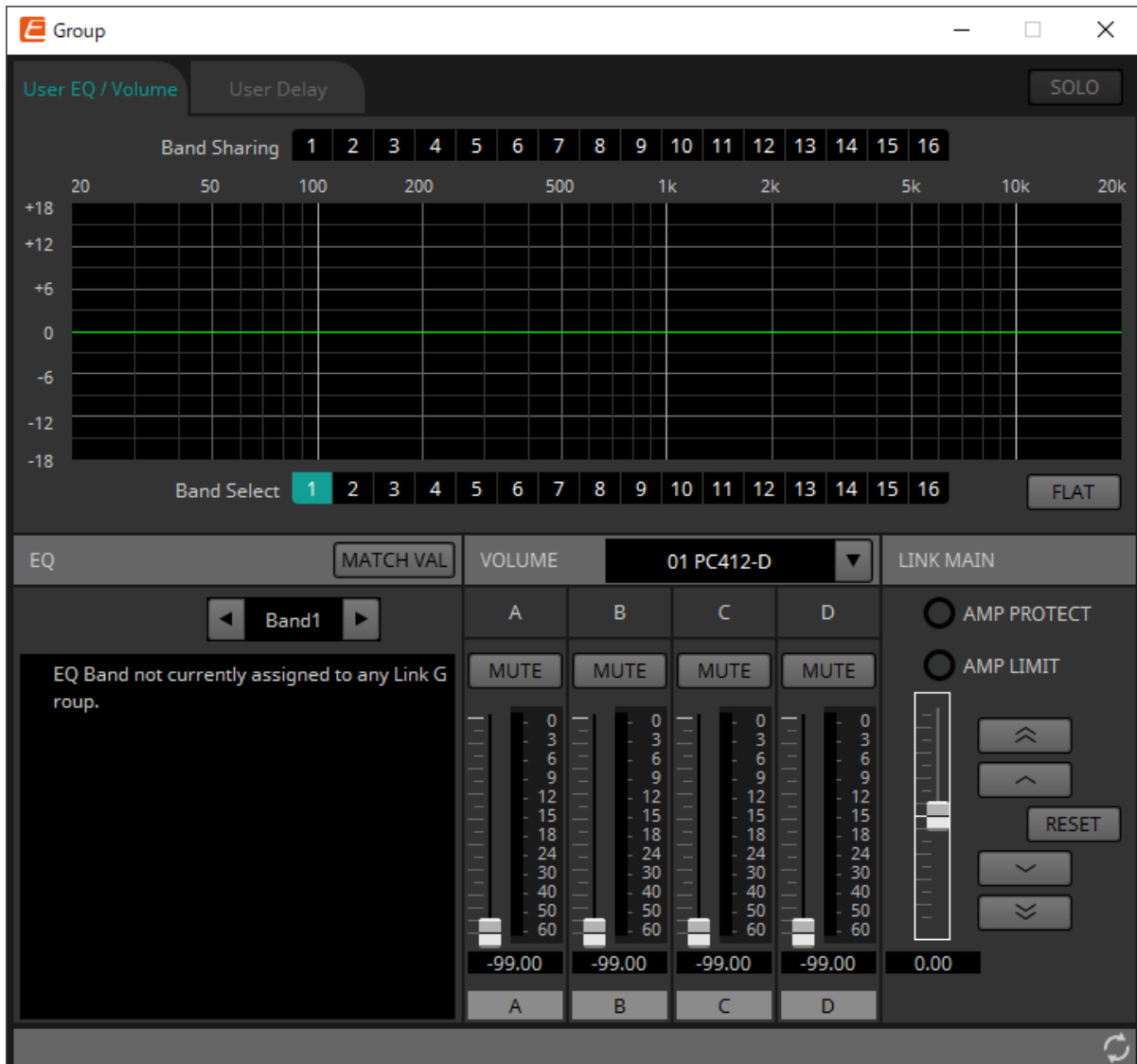

- **[Band Sharing] buttons**

If a channel is registered in multiple groups, click to select the bands owned by each group. An owned band is shown in blue. Bands that are not shown as white numbers on a black background are owned by other groups, and cannot be selected or operated.

Bands that you click and are colored blue are currently owned.

Ownership can be relinquished only by the link group editor that owns that band.

- **[MATCHVAL] button**

Copies the EQ settings of bands owned by the link group editor to the registered channels.

- **LINK MAIN**

Applies a relative adjustment to the volumes within the link group.

- **[AMP PROTECT] indicator**

This will light if the protection function of the PC unit itself is operating.

• **[AMP LIMIT] indicator**

This will light if the limiter of the PC unit itself is operating.

◦ **Master fader**

Applies a relative adjustment to the volumes within the link group. The adjustable range is shown above and below in gray.

When you right-click the fader and choose [Match Values], the members of the link group are set to the same volume value.

◦  **button**

Raises the master fader by 3 dB.

◦  **button**

Raises the master fader by 1 dB.

◦ **[RESET] button**

Moves the master fader to the 0 position.

◦  **button**

Lowers the master fader by 1 dB.

◦  **button**

Lowers the master fader by 3 dB.

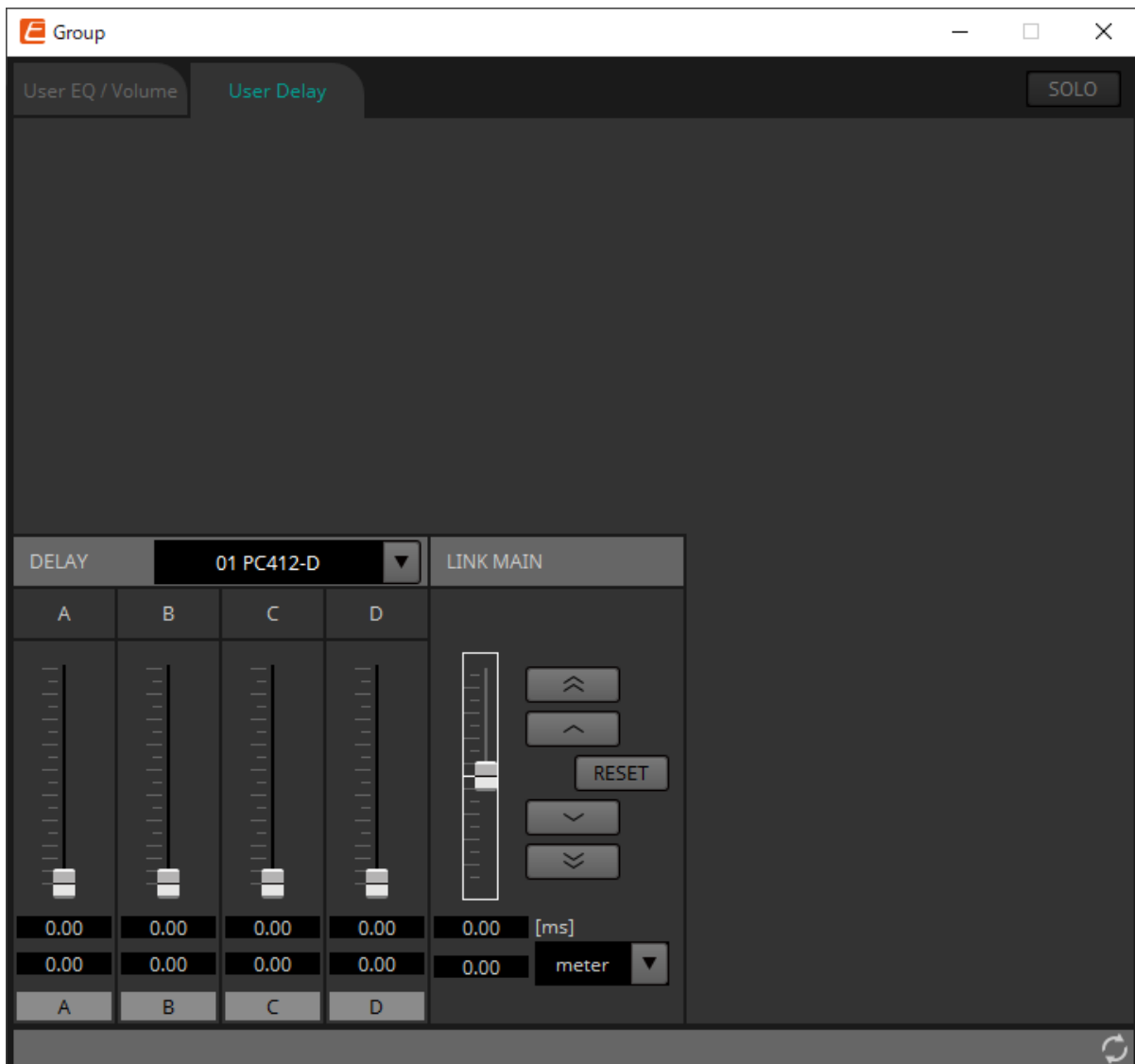

### 17.3.3. [User Delay] tab

Here you can collectively edit the User Delay of the "User EQ/User Delay" component editor for the linked jacks. For details, refer to "[User EQ/User Delay](#)" component editor.





#### • LINK MAIN

Here you can apply a relative adjustment to the delay time of the channels of the devices that are registered in this link group.

- **Master fader**  
Applies a relative adjustment to the delay times within the link group. The adjustable range is shown above and below in gray.  
When you right-click the fader and choose [Match Values], the members of the link group are set to the same delay time value.
-  **button**  
Raises the master fader by 3 ms.
-  **button**  
Raises the master fader by 0.3 ms.
- **[RESET] button**  
Moves the master fader to the 0 position.



-  **button**  
Lowers the master fader by 0.3 ms.
-  **button**  
Lowers the master fader by 3 ms.
- **[ms]**  
Indicates the value of the master fader in ms units.
- **[meter]/[feet] list box**  
Causes the display at left to show units of either meters or feet.  
This also switches the display for individual jacks.

## 17.4. Device sheet screen configuration

When the PC series device sheet is opened, the "Presets" area and the "Bird's Eye view" will be displayed. When you double-click a component in the device sheet, the component editor opens.

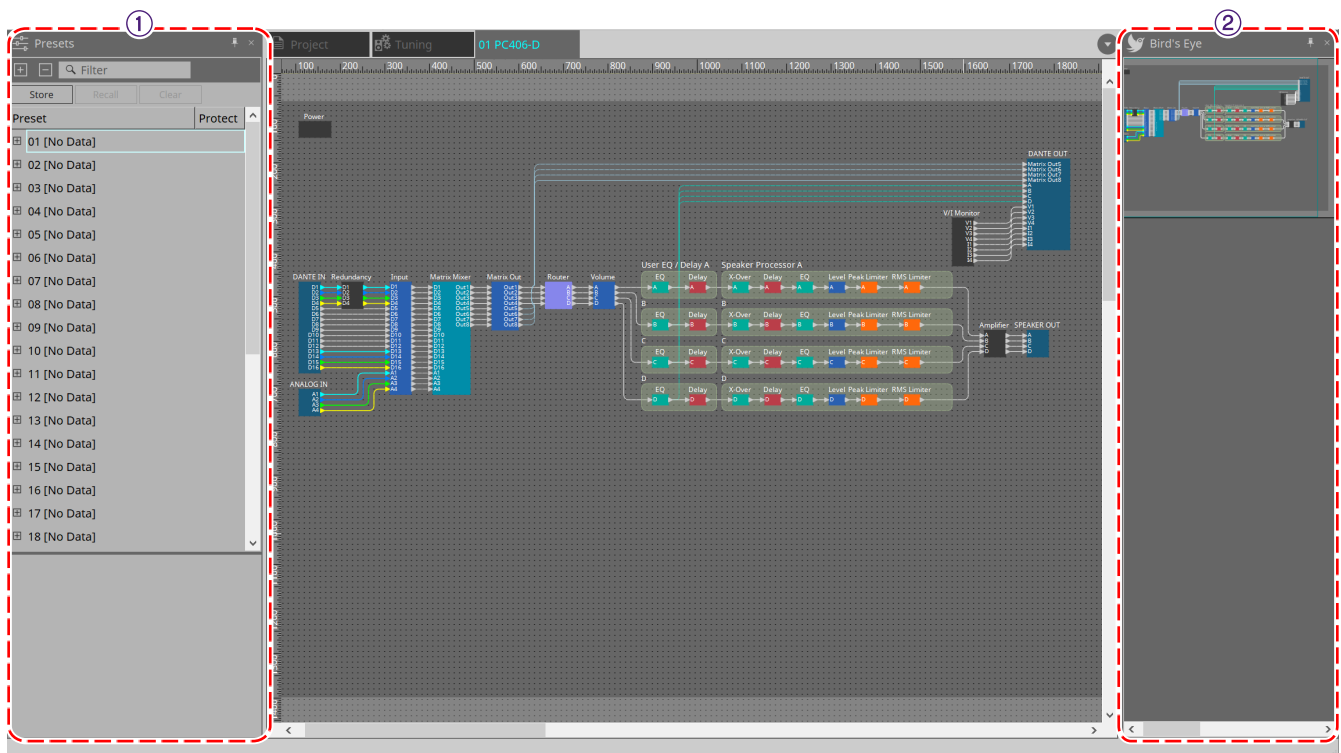

### ① Presets area

Multiple parameter settings can be stored as presets.

### ② Bird's Eye view

This shows an overview of the sheet.

## 17.5. "Presets" area

In this area you can store the settings of multiple parameters as a preset, or recall a stored preset to apply its parameters to the current settings. The parameters of the preset that is applied are called the "current parameters."

If you want to recall presets for multiple units simultaneously, click the  button, and make settings in the "Linked Presets Manager" dialog box .

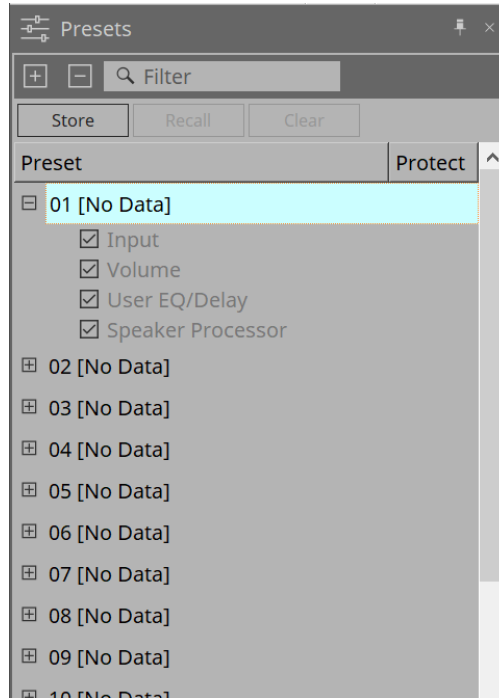

- **[STORE] button**

This button stores a preset. If you select a preset in which settings have not been stored, the "Store Preset" dialog box appears.

- **[RECALL] button**

This button recalls a preset.

- **[CLEAR] button**

This button clears a preset.

- **Preset list**



This displays a list of the presets. Up to 32 presets can be stored.

- **"Preset"**

Shows the preset number and name. You can expand this and select the parameters that will be recalled.

If you select a stored preset and double-click this area, you'll be able to edit the name. Empty presets are shown with the name [No Data].

- **"Protect"**

If you click the lock icon () , the icon changes to  , protecting the preset so that it cannot be edited or cleared.

If you click the icon in the protected state, protection is removed.

### 17.5.1. "Store Preset" dialog box

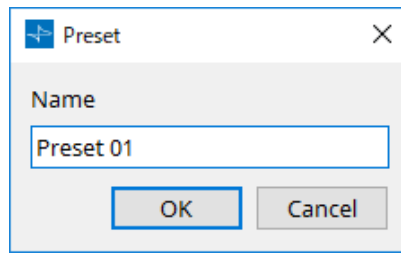

- **[Name]**  
Input the name of the preset. By default, this will be "Preset + preset number." You cannot enter a blank preset name.
- **[OK] button**  
This stores the preset and closes the dialog box.
- **[Cancel] button**  
This cancels the preset store operation, and closes the dialog box.

## 17.6. Context Menu

### 17.6.1. "Tuning" sheet

The following context menu appears when you right-click the "Tuning" sheet.

Menu	Content
[Select All]	[All Link Groups] Selects all link groups in the sheet.
[Close All Editor Windows]	Closes all editors.
[Snap to Grid]	If this is checked, objects are placed in alignment with the grid of the sheet.

### 17.6.2. Link group in the "Tuning" sheet

The following context menu appears when you right-click a link group, although certain menu items may be present or absent.

Menu	Content
[Open Link Group Editor]	Opens the link group editor. For details on the link group editor, refer to each device.
[Open Amplifier Sheet]	Opens the device sheet of the selected amp.
[Identify]	Causes the indicators of the amp to flash for several seconds. If a channel is selected on the PC-series amp, this causes the channel indicator to flash for several seconds.
[Delete]	If a channel is selected, this deletes the channel from the link group. If a device is selected, this deletes the device from the link group. If a link group is selected, this deletes the link group.
[Bring to Front]	Moves the link group to the foreground.
[Bring to Back]	Moves the link group to the background.

### 17.6.3. "Project Devices" area

The following context menu appears when you right-click a device or channel in the "Project Devices" area.

Menu	Content
[Find]	Places the focus on the link group in which the device or channel is registered.
[Add to Link Group]	Registers the amp's channels in a link group. If the speaker is connected to an amp, this registers the channel of the connected amp.

### 17.6.4. "Link Groups" area

The following context menu appears when you right-click an object in the "Link Groups" area.

Menu	Content
[Find]	If you right-clicked a device, this places the focus on that device in the link group, and opens the link group component editor. If you right-clicked a channel or a link group, this places the focus on the channel within the link group or on the link group, and opens the link group editor.
[Delete]	If you right-clicked a channel, this deletes the channel from the link group. If you right-clicked a device, this deletes the device from the link group. If you right-clicked a link group, this deletes the link group.

### 17.6.5. Device sheet

When you right-click on a device sheet in a location with no object, the following context menu will be displayed.

Menu	Details
[Close All Editor Windows]	Closes all editors.
[Debug Mode]	-

### 17.6.6. Components in the device sheet/component editor

When you right-click on any location other than the component's operator or component, the following context menu will be displayed (some items may be omitted).

Menu	Details
[Open Component Editor]	Opens the component editor.
[Copy]	Copies the component editor's parameter settings.
[Paste Parameters]	Reflects the component editor's parameter settings that have been copied.

### 17.6.7. "Presets" area

When you right-click on a preset, the following context menu will be displayed.

Menu	Details
[All On]	Checks all of the checkboxes that are subject to recall.
[All Off]	Unchecks all of the checkboxes that are subject to recall.

## 17.7. Alert list

The alerts generated by PC-series units, and their significance and the appropriate actions, are listed below. A single alert is shown when the event occurs. A continuing alert is shown when the event occurs and when it ends.

If the problem is not solved, please contact a Yamaha service center listed at the end of the device's operating manual.

Number	Message	Severity	Content	Action	Single/Continuing
05	Amplifier Output Muting	Error	The protection function operated to mute the amp output.	Take action to clear the protection function that was the cause. The cause is indicated by another alert that is shown at the same time.	Continuing
12	Mains Voltage Over 276[V]	Error	(at startup) The amp cannot start up because the power supply voltage exceeded the allowable operating voltage.	Connect a stable power supply that is within the power supply requirements.	Single
			The amp stopped because the power supply voltage exceeded the allowable operating voltage.		Continuing
13	Power Supply Output Voltage	Fault	(at startup) The amp cannot start up because there is an abnormality in the output voltage of the power supply circuit.	It might be that the unit has malfunctioned. Contact a Yamaha service center.	Single
			The amp was stopped because an abnormality occurred in the output voltage of the power supply circuit.		Continuing
14	Power Supply Over-temperature	Error	(at startup) The amp cannot start up because the power supply circuit is too hot.	<ul style="list-style-type: none"> <li>- Lower the temperature before use.</li> <li>- Clean the air intake.</li> <li>- Lower the room temperature.</li> </ul>	Single
			The amp was stopped because the power supply circuit became abnormally hot.		Continuing

Number	Message	Severity	Content	Action	Single/Continuing
21	Amplifier Ch.* DC Output	Fault	(at startup) The amp cannot start up because there is an abnormality in the amp output.	It might be that the unit has malfunctioned. Contact a Yamaha service center.	Single
			The amp was stopped because there is an abnormality in the amp output of the corresponding channel.		Continuing
22	Amplifier Ch.* Overcurrent	Error	The output was muted because excessive current flowed to the amp of the corresponding channel.	<ul style="list-style-type: none"> <li>- Reduce the output volume so that the current value does not become excessive.</li> <li>- The speaker output jack might be shorted.</li> </ul>	Continuing
23	Amplifier Ch.* Overtemp Level 1	Error	Because the amp temperature of the corresponding channel exceeded level 1, the fan rotation speed was raised and the limiter was applied to the output.	<ul style="list-style-type: none"> <li>- Reduce the output volume so that the temperature does not become excessive.</li> <li>- Clean the filter. Also, keep the room temperature constant.</li> </ul>	Continuing
24	Amplifier Ch.* Overtemp Level 2	Error	Because the amp temperature of the corresponding channel exceeded level 2, the fan rotation speed was raised and the limiter was applied to the output.		Continuing
25	Amplifier Ch.* Overtemp Level 3	Error	Because the amp temperature of the corresponding channel exceeded level 3, the fan rotation speed was raised to the maximum and the output was muted.		Continuing
26	Ch.* High Load	Warning	The impedance value of the corresponding channel monitored by the Load Monitoring function is higher than the specified value.	<ul style="list-style-type: none"> <li>- Check that there is no abnormality in the speaker or cable.</li> <li>- Check that the Threshold setting value is appropriate.</li> </ul>	Continuing
27	Ch.* Low Load	Warning	The impedance value of the corresponding channel monitored by the Load Monitoring function is lower than the specified value.		Continuing



Number	Message	Severity	Content	Action	Single/Continuing
31	Fan * Error	Fault	The fan of the corresponding number has stopped rotating.	It might be that the unit has malfunctioned. Contact a Yamaha service center.	Continuing
42	Input D* Change To 2nd	Warning	The Input Redundancy Backup function has switched the audio to the second priority circuit.	Check whether the main audio circuit (Dante) has malfunctioned. (Note that if the Auto Return function is ON, the circuit might suddenly switch back if the connection recovers.)	Single
43	Input D* Change To 3rd	Warning	The Input Redundancy Backup function has switched the audio to the third priority circuit.	Check whether the main or the second priority audio circuit (Dante) has malfunctioned. (Note that if the Auto Return function is ON, the circuit might suddenly switch back if the connection recovers.)	Single
61	Dante Module Failed	Fault	The internal Dante module is not working correctly.	It might be that the unit has malfunctioned. Contact a Yamaha service center.	Continuing
63	Firmware Versions Mismatch	Error	The version of this unit's firmware is not compatible with the version of the Dante firmware.	The updater provided on the web contains the firmware for this unit and the Dante firmware as a set. Update both.	Single
64	Dante Is Not Working By Giga Bit	Error	A device that does not support gigabit Ethernet is connected. In Daisy Chain mode, this alert also occurs when connected to the Control Port. If this unit is disconnected from the network, alert 69 occurs, and this alert is temporarily cleared.	If you want to transmit audio via Dante, use devices that support gigabit Ethernet.	Continuing
65	Dante Is Working At Secondary	Warning	In Redundant mode, Dante audio communication is occurring on the Secondary circuit. If this unit is disconnected from the network, alert 69 occurs, and this alert is temporarily cleared.	Check whether the primary circuit may have malfunctioned.	Continuing

Number	Message	Severity	Content	Action	Single/Continuing
66	Error Occurred At Secondary Port	Warning	In Redundant mode, the Dante Primary circuit is operating correctly, but the Secondary circuit is not connected. * Only if connection had once been confirmed, and then been disconnected	If connection of the Secondary circuit is needed, check whether it may have malfunctioned.	Continuing
67	Wrong Word Clock	Warning	A problem was detected in the word clock.	- In Dante Controller, correctly set the word clock of the entire system. - Make sure that the Fs (sampling frequency) setting is the same for the devices whose audio is patched.	Continuing
69	Dante Port Is Not Connected	Warning	In Redundant mode, the Dante Primary circuit is operating correctly, but the Secondary circuit is not connected. * This is displayed only if connection had once been confirmed, and then been disconnected.	Make sure that the Dante circuit is correctly connected.	Continuing

## 17.8. Component editors

When you double-click a component in the device sheet, the component editor opens.

This section describes the PC series component editor, and the dialogs and windows that are closely associated with the components. For details about other components, refer to the ["ProVisionaire Design DME7 Component Guide"](#).

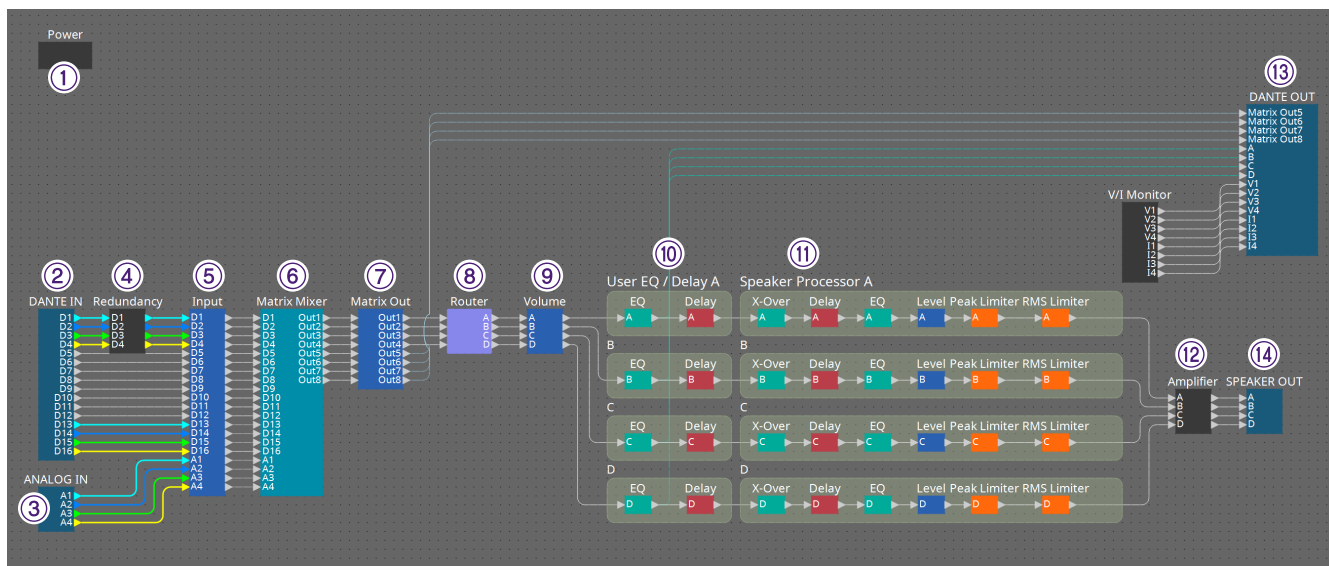

Number	Component name	Details	Link
①	Power	This function switches the device's power supply and displays the electrical current value for the main unit.	<a href="#">"Power" component editor</a>
②	DANTE IN	Displays the settings related to the [Dante] terminal input and the level of the audio signal being input.	<a href="#">"Input Alignment" component editor</a>
③	ANALOG IN	Displays the settings related to the [INPUT] terminal input and the level of the audio signal being input.	<a href="#">"Input Alignment" component editor</a>
④	Redundancy	Sets the input source and Override/Backup operation at a per-channel level.	---
⑤	Input	Adjusts the level of the input channel.	---
⑥	Matrix Mixer	Adjusts the group balance for each output bus.	<a href="#">"ProVisionaire Design DME7 Component Guide"</a>
⑦	Matrix Out	Adjusts the level from the matrix mixer to the router and Dante outputs.	---
⑧	Router	Assigns matrix mixer output to output channels.	<a href="#">"ProVisionaire Design DME7 Component Guide"</a>

Number	Component name	Details	Link
⑨	Volume	Adjusts the level of the output channel.	---
⑩	User EQ/Delay	Sets the output channel EQ/delay.	<a href="#">"User EQ/User Delay" component editor</a>
⑪	Speaker Processor	Sets the output channel speaker processor.	<a href="#">"Speaker Processor" component editor</a>
⑫	Amplifier	Set the amp output mode and impedance detector.	<a href="#">"Amplifier" component editor</a>
⑬	DANTE OUT	Shows the Dante output level.	---
⑭	SPEAKER OUT	Displays the speaker output terminal's output voltage and output current.	<a href="#">"Speaker Out" component editor</a>

### 17.8.1. "Power" component editor

Switches the power of the device, and indicates the electrical current value of the unit. This is available only when online.

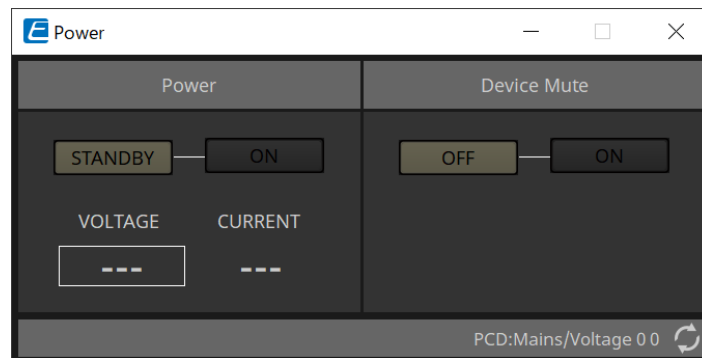

- **Power**

- **[STANDBY]/[ON] buttons**  
Switch the power between standby/on.
- **[VOLTAGE]**  
Indicates the voltage value of the power supply input.
- **[CURRENT]**  
Indicates the electrical current value of the device.

- **Device Mute [OFF]/[ON] buttons**

Switch the device's Device Mute on/off.

If this is on, the speaker output is muted for all channels of the amp.

## 17.8.2. "Input Alignment" component editor

This appears when you double-click the "DANTE IN" component or the "ANALOG IN" component. Here you can make settings for the input jacks, and view the levels of the audio signals that are being input.

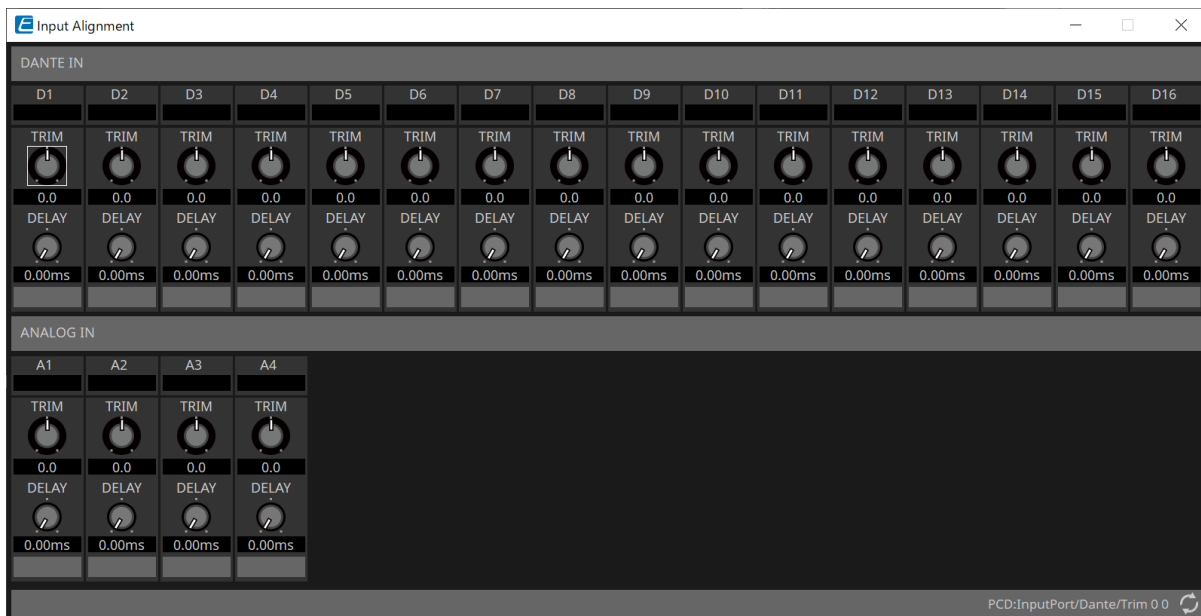

- **Input level**  
Indicates the level after it is compensated by TRIM and DELAY.
- **[TRIM] knob**  
Compensates for level differences between input jacks.
- **[DELAY] knob**  
Compensates for latency differences between input jacks.
- **Channel name**  
Shows or edits the input jack name.

### 17.8.3. "User EQ/User Delay" component editor

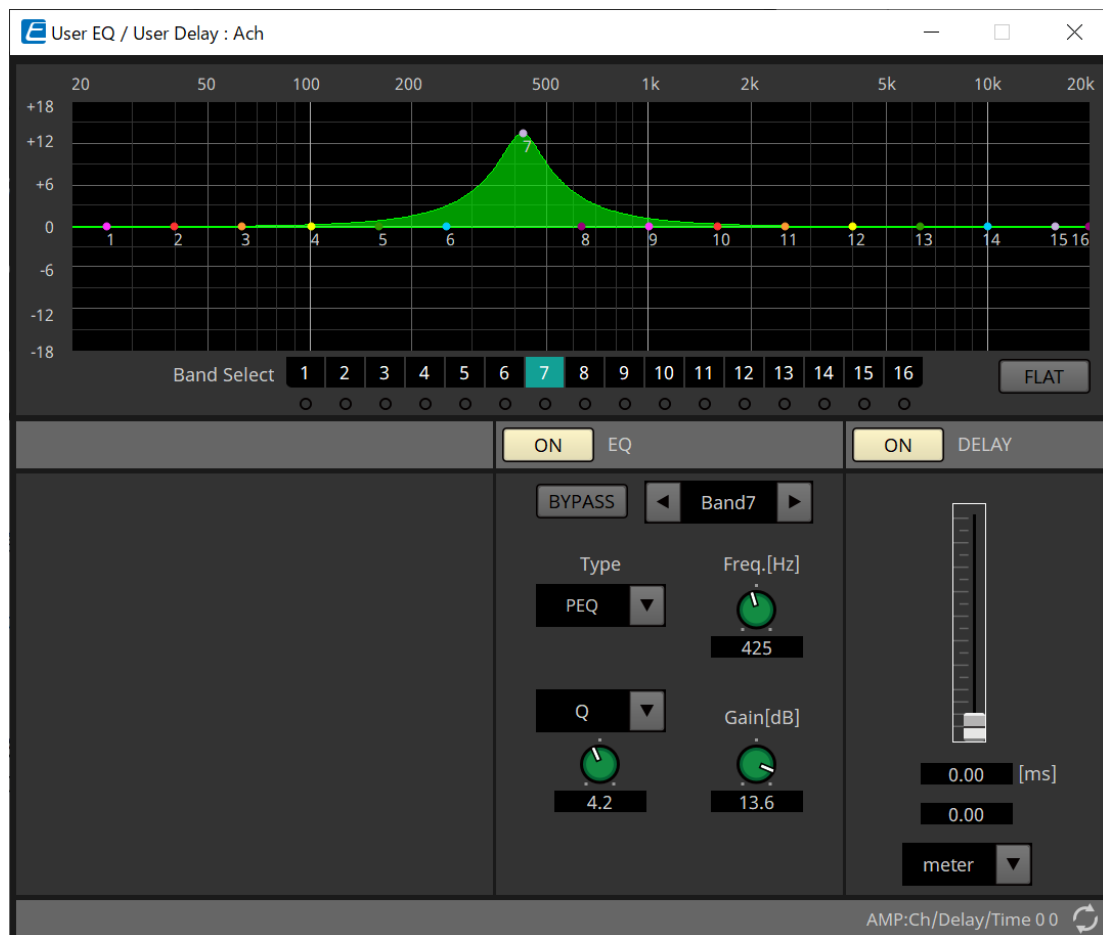

- **EQ graph**

Shows a graph of the EQ effect.

You can drag a control point to edit the parameters.

- **[Band Select] buttons**

If a button is selected, the current value is shown in "EQ," below. For bands whose "EQ" [BYPASS] button is on, the indicator below that [Band Select] button is lit.

For details about other parameters, refer to the ["ProVisionaire Design DME7 Component Guide"](#).

### 17.8.4. "Speaker Processor" component editor

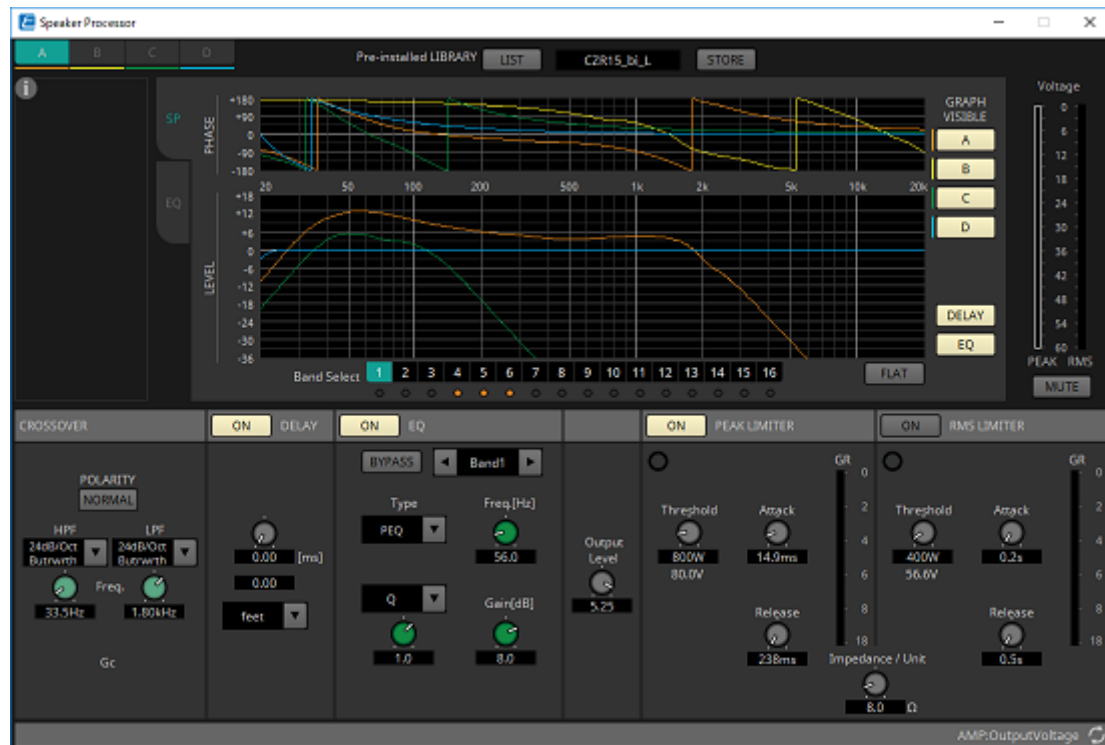

#### 「PEAK LIMITER」 / 「RMS LIMITER」

This is not shown if the corresponding jack is set as a high-impedance connection such as 70V or 100V.

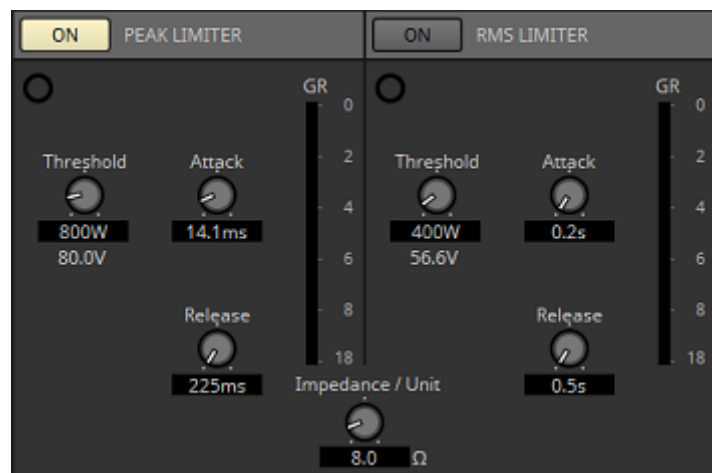

- **[ON] button**  
Turns the limiter on/off. If the button is off, the limiter will be bypassed.
- **Gain Reduction indicator**  
This will light when the threshold value is exceeded.
- **[Threshold] knob**  
This specifies the threshold value at which the limiter applies, in terms of output power (W).
- **[Attack] knob**  
Specifies the speed at which the limiter will take effect.
- **[Release] knob**  
Specifies the speed at which the limiter will release.
- **"GR" meter**  
Indicates the amount of gain reduction.



- **[Impedance / Unit] knob**

Specifies the nominal impedance of the speaker.

Even when connecting multiple speakers in parallel, specify this as the impedance of one unit.

For other information, refer to the "[ProVisionaire Design DME7 Component Guide](#)".

## 17.8.5. "Amplifier" component editor

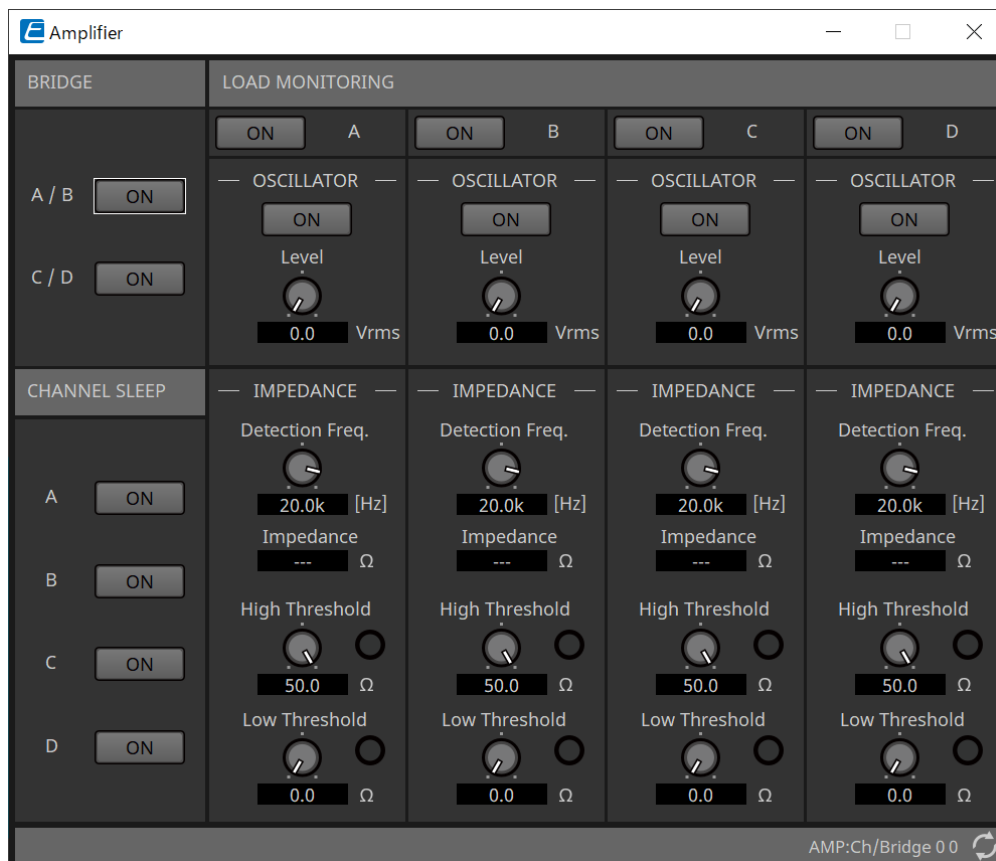

- **BRIDGE [ON] button**

If this is enabled, the amp will be in BRIDGE output mode.

In BRIDGE mode, adjacent odd-numbered and even-numbered channels are bridge-connected to operate as a high-power amp.

- **CHANNEL SLEEP [ON] button**

If this is enabled, the amp of that channel will sleep. By putting unused channels to sleep, you can conserve electrical power and reduce excessively high temperatures.

This is different than the Auto Sleep setting in the "Properties" area of the "Project" sheet.

- **"LOAD MONITORING"**

Here you can make settings for monitoring the speaker output impedance in order to determine whether the output has been interrupted by an electrical short, breakage, or speaker malfunction. By outputting a pilot tone, the impedance can be detected in a stable manner without relying on the audio signal output. This is not shown for channels that are specified as a Hi-Z connection.

- **[ON] button**

Switches LOAD MONITORING on/off.

- **OSCILLATOR [ON] button**

Specifies whether a pilot tone is output.

A pilot tone from an external input can also be used to detect the impedance.

- **OSCILLATOR [Level] knob**

Specifies the output level of the pilot tone.

- **IMPEDANCE [Detection Freq.] knob**

Specifies the frequency for which impedance is detected. The [Impedance] field below shows the measured impedance.

- **IMPEDANCE [High Threshold] knob/indicator**

Specifies the upper threshold of impedance that is measured. If the specified value is exceeded, it

is determined that the speaker has malfunctioned, and the indicator will light.

If the specified value is exceeded, it might be that the connection is open, such as due to a broken cable.

- **IMPEDANCE [Low Threshold] knob/indicator**

Specifies the lower threshold of impedance that is measured. If the measurement drops below the specified value, it is determined that the speaker has malfunctioned, and the indicator will light.

If the measurement drops below the specified value, it might be that the resistance has dropped due to a shorted coil, etc.

## 17.8.6. "Speaker Out" component editor

This shows the speaker output jack's output voltage and output current.

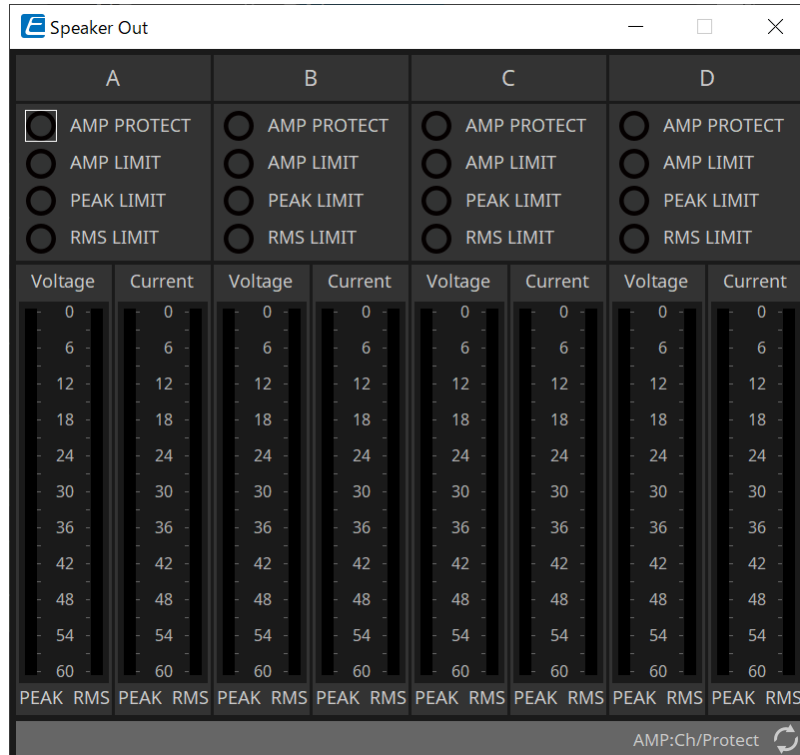

- **[AMP PROTECT] indicator**  
This will light if the protection function of the PC unit itself is operating.
- **[AMP LIMIT] indicator**  
This will light if the limiter of the PC unit itself is operating.
- **[PEAK LIMIT] indicator**  
This is lit if the peak limiter within the speaker processor of the PC unit is operating.
- **[RMS LIMIT] indicator**  
This is lit if the RMS limiter within the speaker processor of the PC unit is operating.
- **[Voltage] meter**  
Shows the output voltage as Peak and RMS.
- **[Current] meter**  
Shows the output current as Peak and RMS.

# 18. Power Amplifiers: XMV-series

## 18.1. Overview

The XMV series is a Class D power amplifier that offers high efficiency while also incorporating functions optimized for commercial spaces. In addition to analog inputs and outputs, the system is equipped with the newly developed "YDIF" digital audio format or "Dante" network audio. The YDIF-compatible models that are connected using Ethernet cables simplify setup, while the Dante models enable high-quality digital transmission in large-scale facilities.

## 18.2. "Project" sheet

When placing devices, the Settings screen shown below will be displayed.

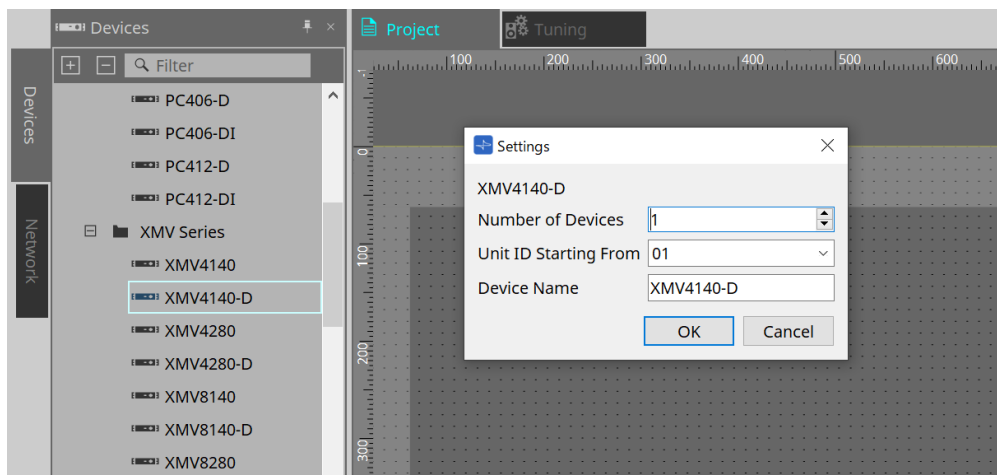

- **Number of Devices**  
Selects the number of XMV series units placed on the sheet.
- **Unit ID Starting From**  
You can select the starting number for the device Unit IDs.
- **Device Name**  
The device name can be displayed and edited.

## 18.2.1. "Properties" area

### "Input Source & Redundancy"

Here you can specify for each channel whether the input source to the XMV will be digital or analog. If the input source is specified as digital, you can specify that the input source will switch from digital to analog when a pilot tone or analog input is detected. Here we explain the screen for when the digital input is Dante.

When you click on the Value field for each channel in the Properties Area "Input Source & Redundancy," and then click the "..." that is displayed, the "Input Source & Redundancy" dialog will be displayed.

The screenshot shows the "Input Source & Redundancy" dialog box for Channel A. At the top, there is a "Redundant Mode" dropdown menu set to "Off" and an "Auto Return" checkbox which is unchecked. Below this, the channel is identified as "Ch A". The "Primary Input Source" section has three options: "Dante (Digital)" (selected with a radio button), "Activate Redundant Mode" (unchecked checkbox), and "Analog" (unselected radio button). Under "Dante (Digital)", it says "Channel will switch to Analog Input - A." and "Input Source is Analog Input - A. Redundant mode settings will not apply." The "Redundant Mode - Backup" section includes "Pilot Tone detection setup" with fields for "Frequency" (20.0kHz), "Detection Threshold" (-40.0dBFs), and "Detection Time" (0s). There is also an unchecked "Notch Filter" checkbox and a "Filter Pilot Tone from amplifier channel output" section with a "Q" field set to 10.0. The "Redundant Mode - Override" section has fields for "Override Threshold" (0.0dBu) and "Auto Return Delay" (5s). At the bottom right, there are "Save Changes" and "Cancel" buttons.

- **[Redundant Mode] list box**

Selects the redundancy method.

- **[Off]**  
Redundancy is disabled.
- **[Backup]**  
Switch to analog input when the pilot tone of the digital input is interrupted due to a broken connection or other problem.
- **[Override]**  
Switch to the analog input when analog audio is detected.

- **[Auto Return] check box**

If this check box is selected, operation will be as follows.

- **In the case of Backup mode**  
When the digital input recovers, the input source is switched from analog to digital.
- **In the case of Override mode**  
When the analog input falls below the threshold value, the input source is returned from analog to digital.

- **Channel index**

Shows the input channel number for which to make settings.

- **"Primary Input Source" area**

Here you can specify for each channel whether the input will be digital or analog.

- **[YDIF (Digital)]/[Dante (Digital)] option button**  
The signal of the corresponding channel is taken from YDIF or Dante.

To specify the Dante patching, make settings in Dante Controller.

- **[Active Redundant Mode] check box**

If this check box is selected, the redundancy function is enabled.

The [Redundant Mode] list box determines the redundancy mode. If [Off] is selected, the redundancy function is disabled even if this check box is selected.

- **[Analog] option button**

The signal is taken from the analog input jack of the corresponding channel.

- **"Redundant Mode - Backup" area**

Here you can specify how the pilot tone is detected for each channel.

- **[Frequency] spin box**

Specifies the center frequency of the pilot tone.

- **[Detection Threshold] spin box**

Specifies the input level threshold value for the pilot tone. Input that exceeds the threshold value is considered to be the pilot tone.

- **[Detection Time] spin box**

Specifies the detection time for the pilot tone. If the pilot tone can not be detected for the specified time interval, it is determined that the input has ceased.

- **[Notch Filter] check box**

If this check box is selected, a notch filter is enabled to eliminate the frequency component of the pilot tone so that the pilot tone is not output from the amp.

- **[Q] spin box**

Specifies the width of the frequency band for the notch filter.

- **"Redundant Mode - Override" area**

Here you can specify the conditions under which each channel will switch to the analog input in Override mode.

- **[Override Threshold] spin box**

Specifies the threshold value for the analog input. When the threshold value is exceeded, the input source will switch to analog.

- **[Auto Return Delay] spin box**

If the [Auto Return] check box is selected, this specifies the time after the analog input falls below the threshold value until the input is switched back to the digital input.

- **[Save Changes] button**

Saves the settings and closes the dialog box.

- **[Cancel] button**

Discards the changes and closes the dialog box.

## 18.3. Tuning Sheet

### 18.3.1. Link group editor

This appears when you double-click a link group on the "Tuning" sheet in which a channel of a XMV-series unit is registered, or when you right-click and choose [Open Link Group Editor].



### 18.3.2. "ATT"

Here you can make collective adjustments to the attenuator of the channels registered in the group.

Use the Main fader to control the attenuator.



The "LINK MAIN" main fader collectively applies a relative adjustment to the attenuator of the channels registered in the group.

For details on the attenuator, refer to ["Power/ATT/Polarity" component editor](#).



- **ATT list box**  
Lists the amps that are registered in the group.
- **Channel index**  
The channel index of the device.

### 18.3.3. "LINK MAIN"

Applies a relative adjustment to the attenuators within the link group.

- **[AMP PROTECT] indicator**  
This will light if the protection function of the XMV unit itself is operating.
- **[AMP LIMIT] indicator**  
This will light if the limiter of the XMV unit itself is operating.
- **Main fader**  
Applies a relative adjustment to the attenuators within the link group. The adjustable range is shown above and below in gray.  
When you right-click the fader and choose [Match Values], the members of the link group are set to the same attenuator value.
-  **button**  
Raises the main fader by 3 dB.
-  **button**  
Raises the main fader by 1 dB.



- **[RESET] button**  
Moves the main fader to the 0 position.
-  **button**  
Lowers the main fader by 1 dB.
-  **button**  
Lowers the main fader by 3 dB.

## 18.4. Device sheet screen configuration

When you open the device sheet for an XMV-series device, the device sheet and the "Bird's Eye view" appear. When you double-click a component in the device sheet, the component editor opens.

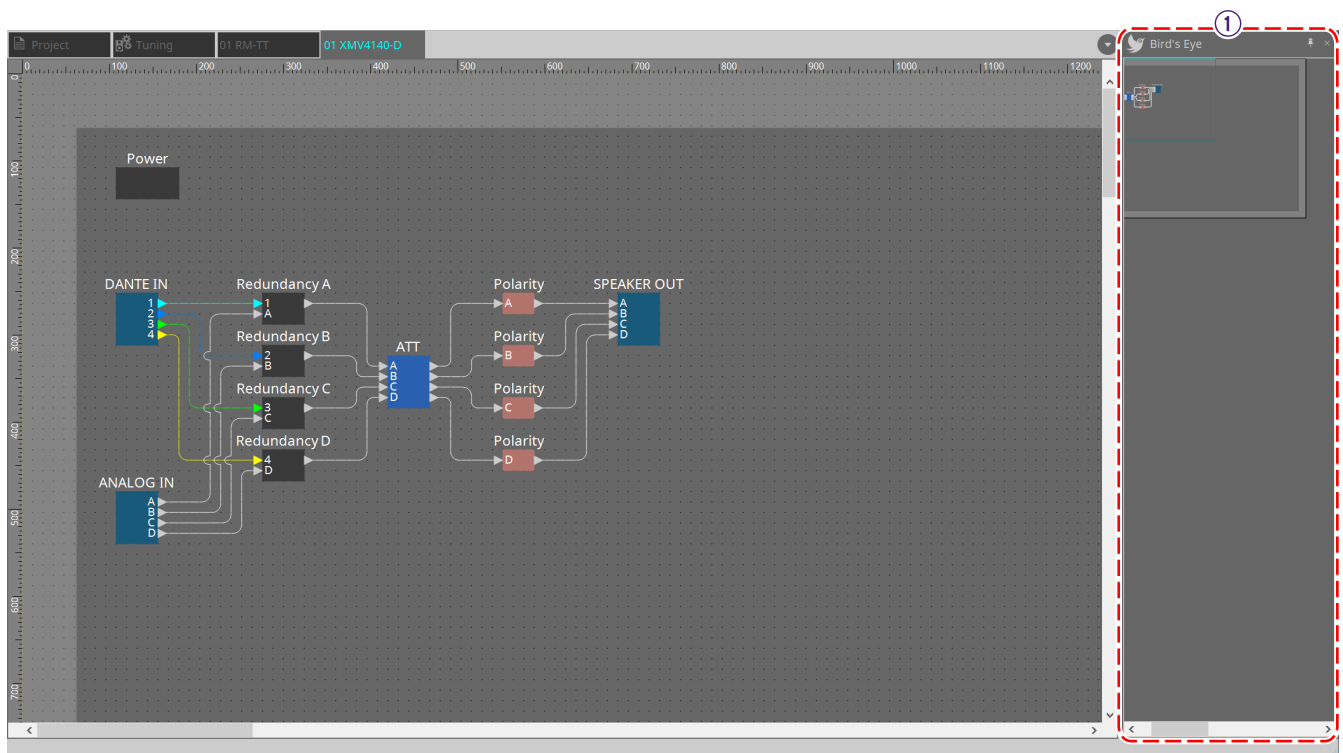

### ① Bird's Eye view

This shows an overview of the sheet.

## 18.5. Context Menu

### 18.5.1. "Tuning" sheet

The following context menu appears when you right-click the "Tuning" sheet.

Menu	Content
[Select All]	[All Link Groups] Selects all link groups in the sheet.
[Close All Editor Windows]	Closes all editors.
[Snap to Grid]	If this is checked, objects are placed in alignment with the grid of the sheet.

### 18.5.2. Link group in the "Tuning" sheet

The following context menu appears when you right-click a link group, although certain menu items may be present or absent.

Menu	Content
[Open Link Group Editor]	Opens the link group editor. For details on the link group editor, refer to each device.
[Open Amplifier Sheet]	Opens the device sheet of the selected amp.
[Identify]	Causes the indicators of the amp to flash for several seconds. If a channel is selected on the PC-series amp, this causes the channel indicator to flash for several seconds.
[Delete]	If a channel is selected, this deletes the channel from the link group. If a device is selected, this deletes the device from the link group. If a link group is selected, this deletes the link group.
[Bring to Front]	Moves the link group to the foreground.
[Send to Back]	Moves the link group to the background.

### 18.5.3. "Project Devices" area

The following context menu appears when you right-click a device or channel in the "Project Devices" area.

Menu	Content
[Find]	Places the focus on the link group in which the device or channel is registered.
[Add to Link Group]	Registers the amp's channels in a link group. If the speaker is connected to an amp, this registers the channel of the connected amp.

#### 18.5.4. "Link Groups" area

The following context menu appears when you right-click an object in the "Link Groups" area.

Menu	Content
[Find]	If you right-clicked a device, this places the focus on that device in the link group, and opens the link group component editor. If you right-clicked a channel or a link group, this places the focus on the channel within the link group or on the link group, and opens the link group editor.
[Delete]	If you right-clicked a channel, this deletes the channel from the link group. If you right-clicked a device, this deletes the device from the link group. If you right-clicked a link group, this deletes the link group.

## 18.6. Alert list

The alerts generated by XMV-series units, and their significance and the appropriate actions, are listed below. A single alert is shown when the event occurs. A continuing alert is shown when the event occurs and when it ends.

Some alerts and information are shown in ProVisionaire Design but not shown on the unit itself.

If the problem is not solved, please contact a Yamaha service center listed at the end of the device's operating manual.

Number	Severity	Content	Action	Single/Continuing
<b>Device abnormality</b>				
001~008	Fault	The device has not started up correctly.	Turn the power off, wait at least five seconds, and then turn the power on. If this does not solve the problem, initialize the memory. If the problem is still not solved, contact a Yamaha service center.	Continuing
10	Fault	The internal backup battery is completely exhausted, or is not installed.	When you turn off the power, the current settings will be lost and will return to the default values. Immediately stop using the unit, and contact a Yamaha service center.	Continuing
11	Error	The internal backup battery is extremely low, and the memory may have been lost.		Continuing
12	Warning	The internal backup battery is low.	The unit will operate correctly, but if you continue using it the settings may be lost and initialized. Contact a Yamaha service center as soon as possible.	Single
13	Fault	An error occurred in the internal clock, and it has been set to the default value (year 2000, January 1st, midnight).	If this occurs each time you turn the power on, it may be that the internal backup battery has run low or that the unit has malfunctioned. Contact a Yamaha service center. If this occurs only once, an abnormality was detected in the value of the clock setting and it has been initialized; use "Clock" dialog box to set the time.	Continuing
15	Fault	The settings saved in internal memory have been lost.	It is possible that the internal backup battery is low, or that the unit may have malfunctioned. Contact a Yamaha service center.	Continuing
16	Fault	It might be that the internal memory of the unit has malfunctioned.	Contact a Yamaha service center.	Continuing
21	Error	The digital signal that is selected as the word clock leader is unlocked.	Check whether the word clock signal is being input correctly.	Continuing

Number	Severity	Content	Action	Single/Continuing
22	Error	The digital signal being input to the [YDIF IN] connector is not synchronized to the word clock of this unit.	Check whether the cable is connected correctly. Use a cable that meets the specifications.	Single
23	Error	The digital signal being input to the [YDIF IN] connector is not continuously synchronized to the word clock of this unit.		Continuing
30	Error	There is a problem with the connection of the [YDIF IN] connector.	Check whether the cable is connected correctly. Use a cable that meets the specifications.	Continuing
40	Error	The IP address is conflicting.	Set the IP address so that it does not conflict.	Continuing
41	Warning	The IP address was not established within 60 seconds of start-up.	If the device's DIP switch 6 (IP SETTING) is set to "PC," use the DHCP server to specify the IP address.	Continuing
43	Error	Too many devices are connected to the network.	Reduce the number of devices that are connected to the network.	Single
46	Error	The Dante transmission flow number limit has been exceeded.	Reduce the flow number, for example by using Dante Controller to change part of the transmission flow to multicast.	Single
50	Error	The UNIT ID is set to "00."	Set the UNIT ID to something other than "00."	Continuing
51	Error	Another device with the same UNIT ID was found connected to the same network.	Set the UNIT ID so that it does not conflict.	Continuing
72	Error	Because Device Lock has been specified for Dante, the DIP switch setting does not match the Dante setting.	If Device Lock is specified, either cancel it from Dante Controller, or reconsider the DIP switch setting so that it is set correctly for the current state.	Continuing
100	Fault	The power supply was shut down because a direct current component was detected at the speaker output jack.	It is likely that the unit has malfunctioned; contact a Yamaha service center.	Continuing
101	Fault	The power supply was shut down because the power supply temperature exceeded the rated value.	Turn off the power, wait for the power supply to cool, and then turn the power on again. Lower the output level, since continuous high wattage output will cause high temperatures. If the temperature is still high, check whether dust or foreign matter might be clogging the cooling fan intake, and clean the intake if necessary.	Continuing

Number	Severity	Content	Action	Single/Continuing
103	Error	The power supply has been shut down by the protection circuit.	Because a high-load situation has continued, you should lower the output level. Refer to the owner's manual for the reason that protection was activated.	Continuing
104	Error	The protection circuit has activated, and output [ch*] is muted.		Continuing
105	Fault	The output was muted because a short was detected in speaker output jack [ch*].	It may be that the + and - of the speaker output jack have shorted, or that the connected speaker has malfunctioned.	Single
106	Warning	The temperature of the amp section (heat sink) has changed, causing the following speaker output status. (*) * = 0dB and OK -1dB and in protection muted and in protection	Lower the output level, since continuous high wattage output will cause high temperatures. If the temperature is still high, check whether dust or foreign matter might be clogging the cooling fan intake, and clean the intake if necessary.	Single
<b>Device information</b>				
200	Information	The power has turned on.	—	Single
201	Information	The power has turned off.	—	Single
202	Information	Firmware update has been completed.	—	Single
203	Information	Initialization has been executed.	—	Single
204	Information	Panel lock has been defeated.	—	Single
205	Information	The IP address has been established.	—	Single
206	Information	The network IP address has been allocated while operating with the DHCP server.	—	Single
207	Information	The network IP address has been released while operating with the DHCP server.	—	Single
211	Information	Synchronization between the Editor and the devices has begun.	—	Single
<b>Amp information</b>				
102	Information	The protection circuit has caused the limiter [ch*] to operate.	Because a high-load situation has continued, you should lower the output level. Refer to the owner's manual for the reason that protection was activated.	Continuing
110	Error	The Redundant Backup function has operated, and channel * has switched to analog input.	There is a problem with the digital signal. Check the connection of the digital circuit, and check whether a pilot tone signal is being input.	Continuing

Number	Severity	Content	Action	Single/Continuing
219	Information	The Power Amp Mode was changed.	—	Single
226	Information	The Redundant Override function has operated, and channel * has switched to analog input.	—	Continuing



## 18.7. Component editors

When you double-click a component in the device sheet, the component editor opens.

This section describes the XMV series component editor, and the dialogs and windows that are closely associated with the components. For details about other components, refer to the "[ProVisionaire Design DME7 Component Guide](#)".

### Dante model

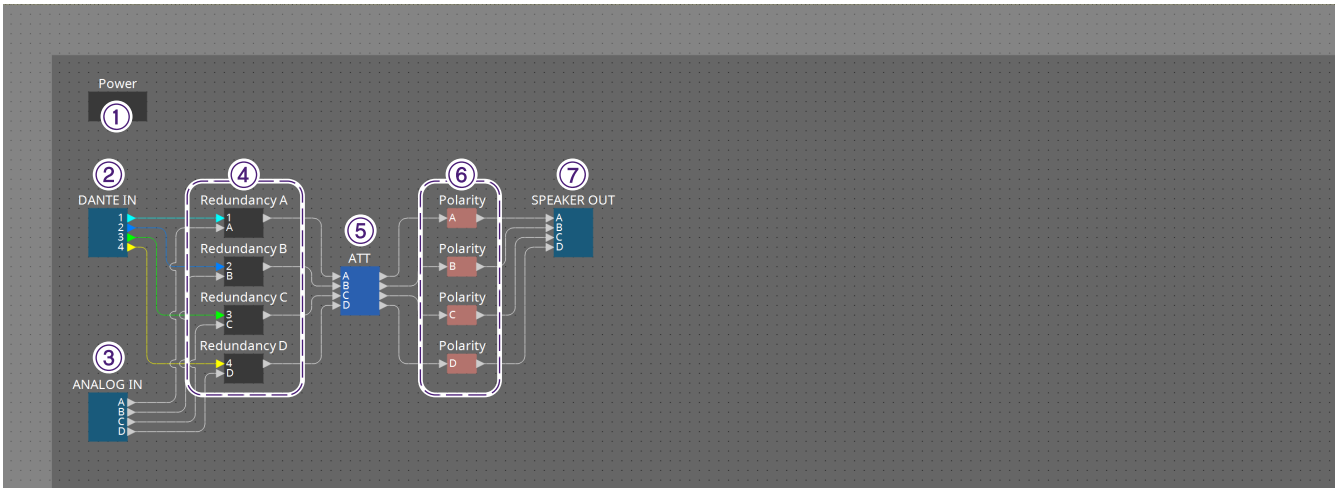

No.	Component name	Details	Link
①	Power	This sets the power supply standby/ON, mute, polarity, and attenuator.	<a href="#">"Power/ATT/Polarity" component editor</a>
②	DANTE IN	Sends the audio signal input from the [Dante] terminal.	-
③	ANALOG IN	Sends the audio signal input from the analog input terminal.	-
④	Redundancy	Sets the pilot tone detection setting during Redundant mode.	<a href="#">"Redundancy" component editor</a>
⑤	ATT	This sets the power supply standby/ON, mute, polarity, and attenuator.	<a href="#">"Power/ATT/Polarity" component editor</a>
⑥	Polarity	This sets the power supply standby/ON, mute, polarity, and attenuator.	<a href="#">"Power/ATT/Polarity" component editor</a>
⑦	SPEAKER OUT	Displays the speaker output terminal's output voltage and output current.	<a href="#">"Speaker Out" component editor</a>

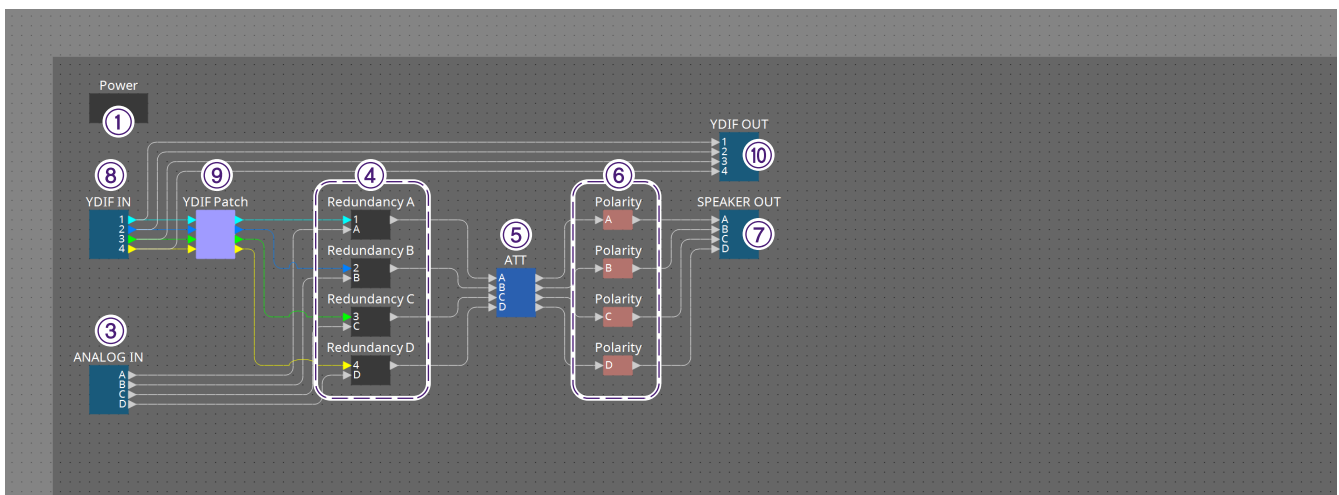

### YDIF model

Number	Component name	Details	Link
①	Power	This sets the power supply standby/ON, mute, polarity, and attenuator.	<a href="#">"Power/ATT/Polarity" component editor</a>
③	ANALOG IN	Sends the audio signal input from the analog input terminal.	-
④	Redundancy	Sets the pilot tone detection setting during Redundant mode.	<a href="#">"Redundancy" component editor</a>
⑤	ATT	This sets the power supply standby/ON, mute, polarity, and attenuator.	<a href="#">"Power/ATT/Polarity" component editor</a>
⑥	Polarity	This sets the power supply standby/ON, mute, polarity, and attenuator.	<a href="#">"Power/ATT/Polarity" component editor</a>
⑦	SPEAKER OUT	Displays the speaker output terminal's output voltage and output current.	<a href="#">"Speaker Out" component editor</a>
⑧	YDIF IN	Sends the audio signal input from the [YDIF] terminal.	-
⑨	YDIF Patch	Selects the YDIF audio channel that will be input to each amplifier's input channel.	<a href="#">"YDIF Patch" component editor</a>

### 18.7.1. "Power/ATT/Polarity" component editor

This appears when you double-click either a "Power" component, "ATT" component, or "Polarity" component.

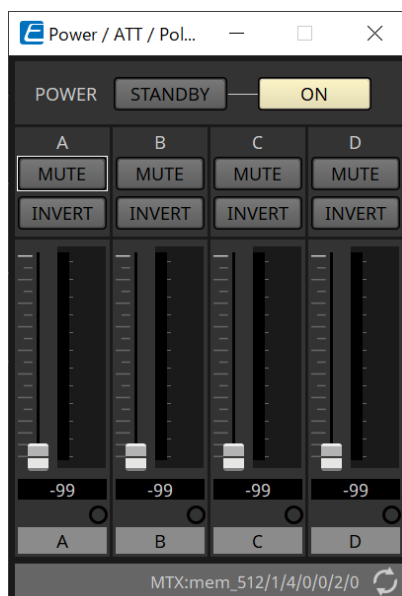

- **[STANDBY]/[ON] buttons**  
Switch the power between standby/on.
- **Channel index**  
Indicates the speaker jack output channel.
- **[MUTE] button**  
Switches mute on/off for the output channel.
- **[INVERT] button**  
Switches the polarity of the output signal.
- **Attenuator**  
Sets the XMV's output attenuator value.
- **Redundancy indicator**  
This will light if the redundancy function has switched the input to analog.
- **Channel name**  
Indicates the channel name. You can double-click this and edit it.

## 18.7.2. "Redundancy" component editor

This appears when you double-click the "Redundancy" component.

This is the component editor to use if you want to make settings while hearing the sound when the redundancy mode is "Backup."

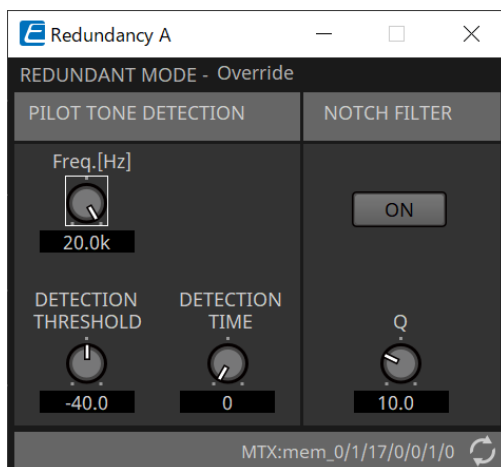

- **"REDUNDANT MODE"**

This indicates the status of redundancy mode.

- **"PILOT TONE DETECTION"**

Here you can make settings for pilot tone detection.

- **[Freq.[Hz]] knob**  
Specifies the center frequency of the pilot tone.
- **[DETECTION THRESHOLD] knob**  
Specifies the input level threshold value for the pilot tone. Input that exceeds the threshold value is considered to be the pilot tone.
- **[DETECTION TIME] knob**  
Specifies the detection time for the pilot tone. If the pilot tone can not be detected for the specified time interval, it is determined that the input has ceased.

- **"NOTCH FILTER"**

Here you can make settings for the notch filter that prevents the pilot tone from being output from the amp.

- **[ON] button**  
If this is on, a notch filter is enabled to eliminate the frequency component of the pilot tone so that the pilot tone is not output from the amp.
- **[Q] knob**  
Specifies the width of the frequency band for the notch filter.

### 18.7.3. "Speaker Out" component editor

This shows the speaker output jack's output voltage and output current.

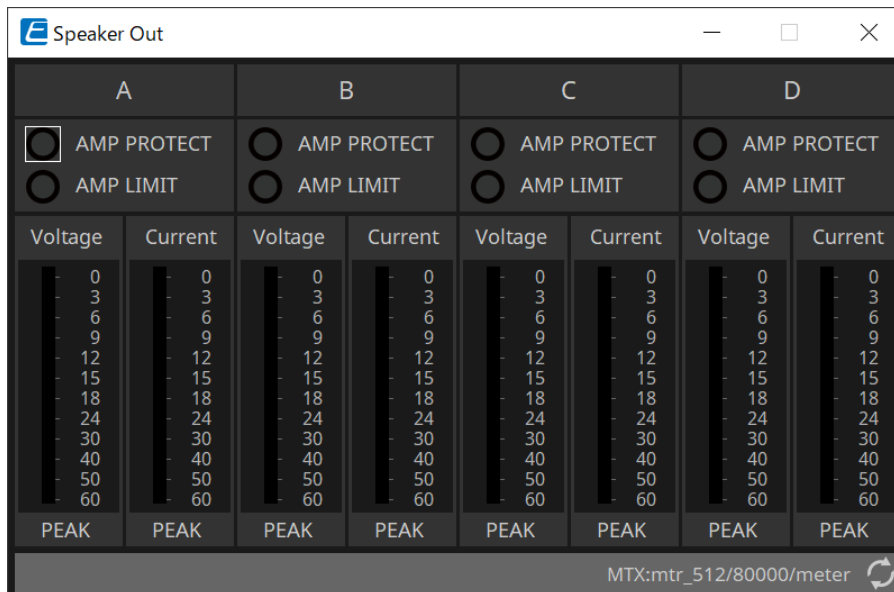

- **[AMP PROTECT] indicator**  
This will light if the protection function of the XMV unit itself is operating.
- **[AMP LIMIT] indicator**  
This will light if the limiter of the XMV unit itself is operating.
- **[Voltage] meter**  
Shows the output voltage as Peak.
- **[Current] meter**  
Shows the output current as Peak.

### 18.7.4. "YDIF Patch" component editor

Selects the YDIF audio channel that will be input to each amplifier's input channel.

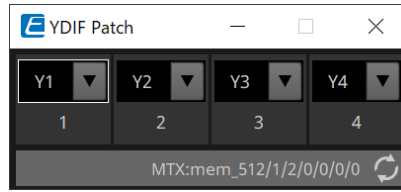

# 19. I/O Interface: Rio3224-D2 / Rio1608-D2

## 19.1. Overview

This is a Dante-compatible I/O rack for use in mixing systems. Input from analog terminals can be converted to Dante output, and Dante input can be converted to output to analog terminals.

Because the Rio3224-D2 is equipped with 8-channel AES/EBU output, it can also convert Dante inputs to digital outputs (AES/EBU).

## 19.2. "Project" sheet

When placing devices, the Settings screen shown below will be displayed.

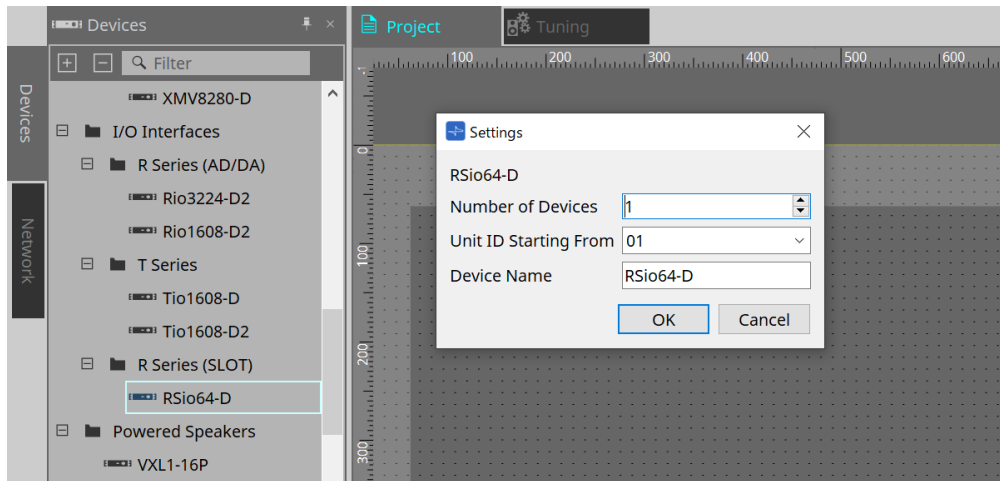

- **Number of Devices**  
Selects the number of Rio units placed on the sheet.
- **Unit ID Starting From**  
You can select the starting number for the device Unit IDs.
- **Device Name**  
The device name can be displayed and edited.

## 19.3. Editor

Double clicking a device on the Project sheet will directly open the editor.  
The Rio1608-D2 displays 16Ch, and the Rio3224-D2 displays 32Ch.



- **+48V ACTIVE**  
Displays whether the phantom function of the device is enabled or disabled.
- **[+48V] button**  
Switches the HA phantom power supply (+48 V) ON and OFF. When the device's phantom function is enabled, the ON for this button is enabled.
- **[PEAK HOLD] button**  
When this button is set to ON, the peak of each level meter is retained. When it is turned OFF, the retained peaks are deleted.
- **[A.GAIN] knob**  
The HA analog gain can be adjusted.
- **[GC] indicator / gain value**  
The ON/OFF status of gain compensation for the R series (AD/DA) is displayed. When gain compensation is ON, the gain value fixed by gain compensation is displayed.
- **[HPF] button**  
When this is turned ON (illuminated), a high-pass filter can be applied to the audio signal.
- **[Freq.] knob**  
The frequency band for high-pass filtering can be adjusted.

## 19.4. Context menu

When you right-click on a Ch space in the Editor, the following context menu will be displayed.

Menu	Details
Identify	The LCD display of the selected device's main unit and the indicators linked to the Ch flash simultaneously.



## 20. I/O Interface: Tio1608-D / Tio1608-D2

### 20.1. Overview

The Tio series is a Dante-compatible I/O rack with 16 mic/line inputs and 8 line outputs. By using the Tio series, the system can be easily expanded to build a stage box system with a maximum of 40 In/24 Out.

### 20.2. "Project" sheet

When placing devices, the Settings screen shown below will be displayed.

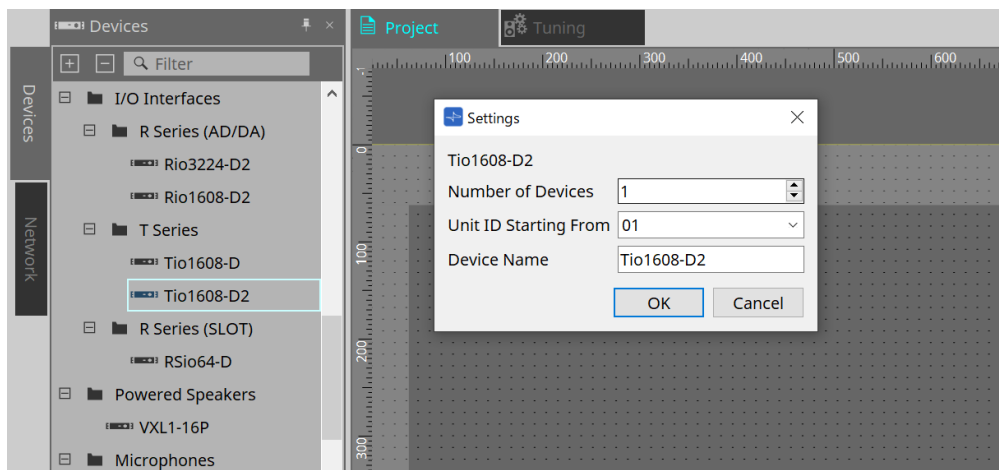

- **Number of Devices**  
Selects the number of Tio units placed on the sheet.
- **Unit ID Starting From**  
You can select the starting number for the device Unit IDs.
- **Device Name**  
The device name can be displayed and edited.

## 20.3. Editor

Double clicking a device on the Project sheet will directly open the editor.



The functions and method of use are the same as the [Rio] editor.

## 21. I/O Interface: RSio64-D

### 21.1. Overview

This I/O rack can be utilized in a wide range of applications, including live sound, broadcasting, and recording, and features maximum 64 in/64 out Dante/Mini-YGDAl card conversion compatibility. The RSio64-D is an audio interface that can convert between Dante and Mini-YGDAl formats for up to 64 inputs and 64 outputs.

### 21.2. "Project" sheet

When placing devices, the Settings screen shown below will be displayed.

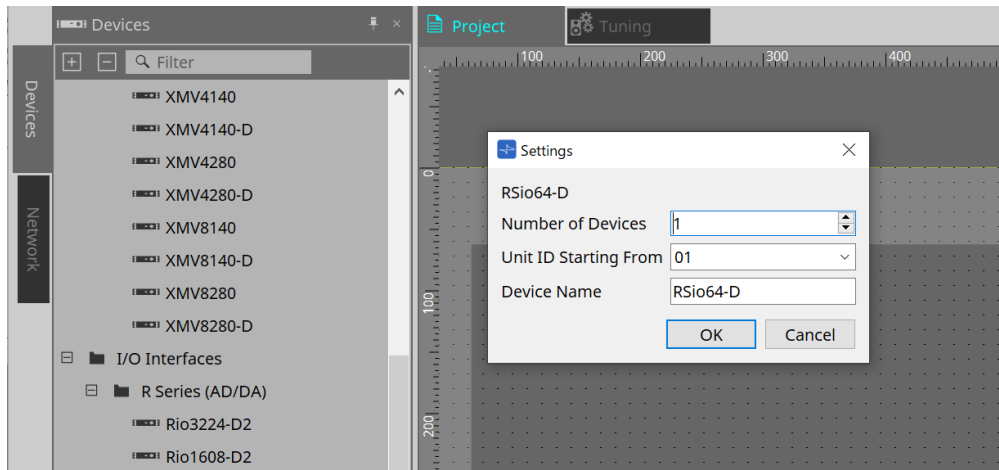

- **Number of Devices**  
Selects the number of RSio units placed on the sheet.
- **Unit ID Starting From**  
You can select the starting number for the device Unit IDs.
- **Device Name**  
The device name can be displayed and edited.

## 21.3. Editor

Double clicking a device on the Project sheet will directly open the editor.

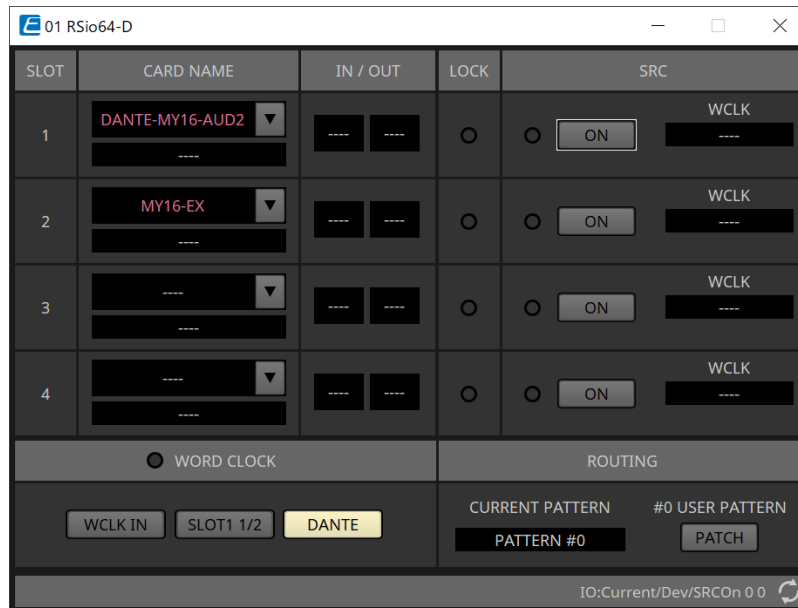

- **[CARD NAME]**

Upper level

Select the card you plan to install in the device.

The "Select Card" dialog opens when you click it.

Lower level

Displays the card that is actually installed in the device.

- **IN/OUT PORT**

This indicates the number of input and output ports for the cards installed in slots 1 to 4. If no card is installed, "--" will appear.

- **[LOCK] indicators**

This indicates the word clock status for slots 1 to 4. If the word clock is operating normally, this indicator will be green.

Unlit	No card is installed in the slot, or an unsupported card is installed.
Green (lit) LOCK	This indicates that a clock synchronized with the clock source selected by the WORD CLOCK select key is being input from the card. If an external device is connected to the corresponding slot, input/output is occurring correctly between that device and the RSio64-D. If the sampling frequency is close, this status is shown in some cases even if not synchronized.
Green (flashing) SYNC ERROR	A valid clock is being input from the card, but is not synchronized with the clock source selected by the WORD CLOCK select key. If an external device is connected to the corresponding slot, input/output is not occurring correctly between that device and the RSio64-D. Input/output will occur correctly if SRC is turned ON.

Red (lit) UNLOCK	A valid clock is not being input from the card. If an external device is connected to the corresponding slot, input/output cannot occur correctly between that device and the RSio64-D.
Red (flashing) WRONG WORD CLOCK	The frequency of the clock source selected by the WORD CLOCK select key is outside the range of operating frequencies of the card installed in the slot. Either set the frequency of the clock source to be within the operating range of the card, or turn SRC on. In the case of an analog card, turning SRC on makes the card operate at the RSio64-D's internal frequency of 48 kHz.

- **[SRC] indicators**

These indicate the SRC (Sampling Rate Converter) status of slots 1 to 4.

Unlit	SRC is off.
Green (lit)	SRC is on, and the clock selected by the SRC WCLK DIP switch is being input correctly.
Red (lit)	SRC is on, but an appropriate clock is not being input. It may be that the clock selected by the SRC WCLK DIP switch is not being input, or is outside the operating range. Either turn SRC off, or change the setting of the DIP switch.

- **[SRC] button**

For each slot, these turn SRC on/off for the slot's input as well as output.

- **WORD CLOCK source**

Indicates the SRC word clock source status for slots 1 to 4 the RSio64-D.

[SLOT]	When using the word clock signal being input from the card in the slot.
[WCLK IN]	When using the word clock signal being input from the WORD CLOCK IN connector on the rear panel.
[CARD]	When the SRC function in the card is on.
[--]	If there is no card in the slot.

- **[WORD CLOCK] select button**

Selects the word clock source of the RSio64-D.

WCLK IN	This is lit if the RSio64-D is using the word clock that is being input from the rear panel [WORD CLOCK IN] connector. This flashes if there is no valid word clock input*1.
SLOT1 1/2	This is lit if the channel 1/2 word clock of slot 1 is being used. This flashes if there is no valid word clock input*1. The channel 7/8 word clock is used when using the MY8-AEB*2. If the SRC on the MY8-AE96S is in use, you will be unable to use the input signal as word clock.
DANTE	This is lit if the Dante network's word clock*3 is being used. (If no valid Dante signal is being input, the clock generated by the internal Dante module is used.)

\*1 When this is flashing, the unit uses the Dante word clock to operate and perform input/output.

\*2 In order to use MY8-AEB, set AE  $\Leftrightarrow$  RSVD switch to the RSVD position.

\*3 If you want to change the frequency of the Dante word clock, use Dante Controller.

- **[CURRENT PATTERN] button**

Displays the currently selected routing pattern on the RSio64-D. When you click on the button, the routing pattern details are displayed.

ROUTING PATTERN																			
PATTERN #0				PATTERN #1				PATTERN #2				PATTERN #3							
SLOT				SLOT				SLOT				SLOT							
1	2	3	4	1	2	3	4	1	2	3	4	1	2	3	4				
48k/44.1k	1-16	1-16	1-16	1-16	48k/44.1k	1-16	1-16	1-16	1-16	48k/44.1k	1-16	1-16	1-16	1-16	48k/44.1k	1-16	1-16	1-16	1-16
96k/88.2k	1-8	1-8	1-8	1-8	96k/88.2k	1-8	1-8	1-8	1-8	96k/88.2k	1-8	1-8	1-8	1-8	96k/88.2k	1-8	1-8	1-8	1-8
USER PATTERN				SLOT				SLOT				SLOT							
1	2	3	4	1	2	3	4	1	2	3	4	1	2	3	4				
48k/44.1k	1-16	17-32	33-48	49-64	48k/44.1k	1-16	17-32	33-48	49-64	48k/44.1k	1-16	17-32	33-48	49-64	48k/44.1k	1-16	17-32	33-48	49-64
96k/88.2k	1-8	9-16	17-24	25-32	96k/88.2k	1-8	9-16	17-24	25-32	96k/88.2k	1-8	9-16	17-24	25-32	96k/88.2k	1-8	9-16	17-24	25-32
1	2	3	4	1	2	3	4	1	2	3	4	1	2	3	4				
DANTE				DANTE				DANTE				DANTE							
PATTERN #4				PATTERN #5				PATTERN #6				PATTERN #7							
SLOT				SLOT				SLOT				SLOT							
1	2	3	4	1	2	3	4	1	2	3	4	1	2	3	4				
48k/44.1k	1-16	1-16	1-16	1-16	48k/44.1k	1-16	1-16	1-16	1-16	48k/44.1k	1-16	1-16	1-16	1-16	48k/44.1k	1-16	1-16	1-16	1-16
96k/88.2k	1-8	1-8	1-8	1-8	96k/88.2k	1-8	1-8	1-8	1-8	96k/88.2k	1-8	1-8	1-8	1-8	96k/88.2k	1-8	1-8	1-8	1-8
48k/44.1k	1-16	17-32	33-48	49-64	48k/44.1k	1-16	17-32	33-48	49-64	48k/44.1k	1-16	17-32	33-48	49-64	48k/44.1k	1-16	17-32	33-48	49-64
96k/88.2k	1-8	9-16	17-24	25-32	96k/88.2k	1-8	9-16	17-24	25-32	96k/88.2k	1-8	9-16	17-24	25-32	96k/88.2k	1-8	9-16	17-24	25-32
1	2	3	4	1	2	3	4	1	2	3	4	1	2	3	4				
DANTE				DANTE				DANTE				DANTE							

- **[Patch] button**

When you click the button, the edit window opens.

Edits the Patch to be applied when 0 (User Pattern) is selected on the rotary switch used to select the Routing Pattern on the main unit.

PATCH																							
User Pattern																0	CLEAR						
Pattern(View Only)																1	2	3	4	5	6	7	Paste to #0
DANTE																							
SLOT 1																							
15	16	1	2	3	4	5	6	7	8	9	10	11	12	13	14	15	16	17					
1		●																					
2			●																				
3				●																			
4					●																		
5						●																	
6							●																
7								●															
8									●														
9										●													
10											●												
11												●											
12													●										
13														●									

- **[User PATTERN] / [Pattern(View Only)] button**

When User Pattern is selected, the patch can be edited.

When Pattern (View Only) is selected, seven types of templates are called. They cannot be edited.

When you click the [Paste to #0] button while Pattern (View Only) is selected, the template is copied to

User Pattern.

When editing, please use the template as a basis.

- **[CLEAR] button**

When you click this while User Pattern is selected, all of the patches will be cleared.

## 22. Powered Speakers: VXL1-16P

### 22.1. Overview

This is a Dante powered speaker using a PoE power supply.

### 22.2. "Project" sheet

When placing devices, the Settings screen shown below will be displayed.

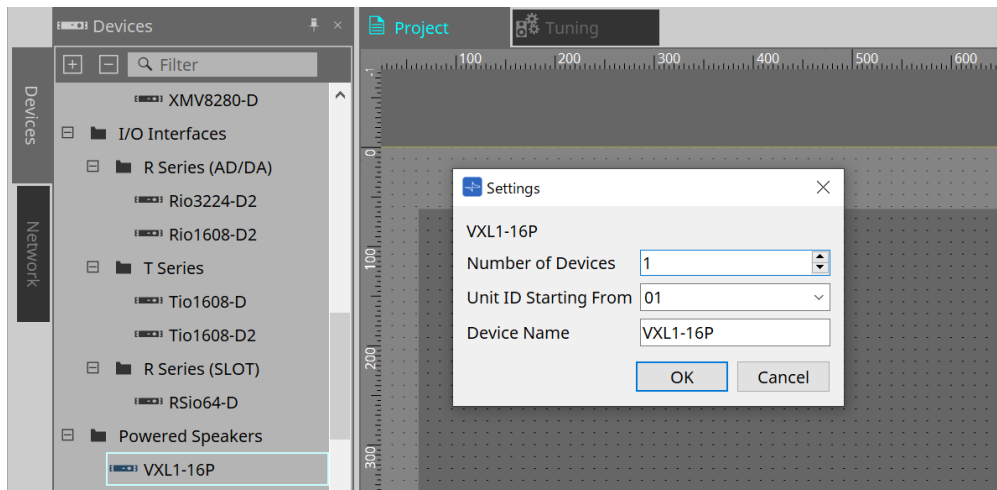

- **Number of Devices**

Selects the number of VXL1-16P units placed on the sheet.

- **Unit ID Starting From**

You can select the starting number for the device Unit IDs.



When the dipswitch on the device's main unit is set to "RESERVED," the device's UNIT ID can be set to a value other than 101 to 115 (hexadecimal: 65 to 73) using the "Network" area > Unit ID button on the Project sheet.

- **Device Name**

The device name can be displayed and edited.



## 22.3. Device sheet screen configuration

When the XL1-16P device sheet is opened, the device sheet and the "Bird's Eye view" will be displayed. When you double-click a component in the device sheet, the component editor opens.

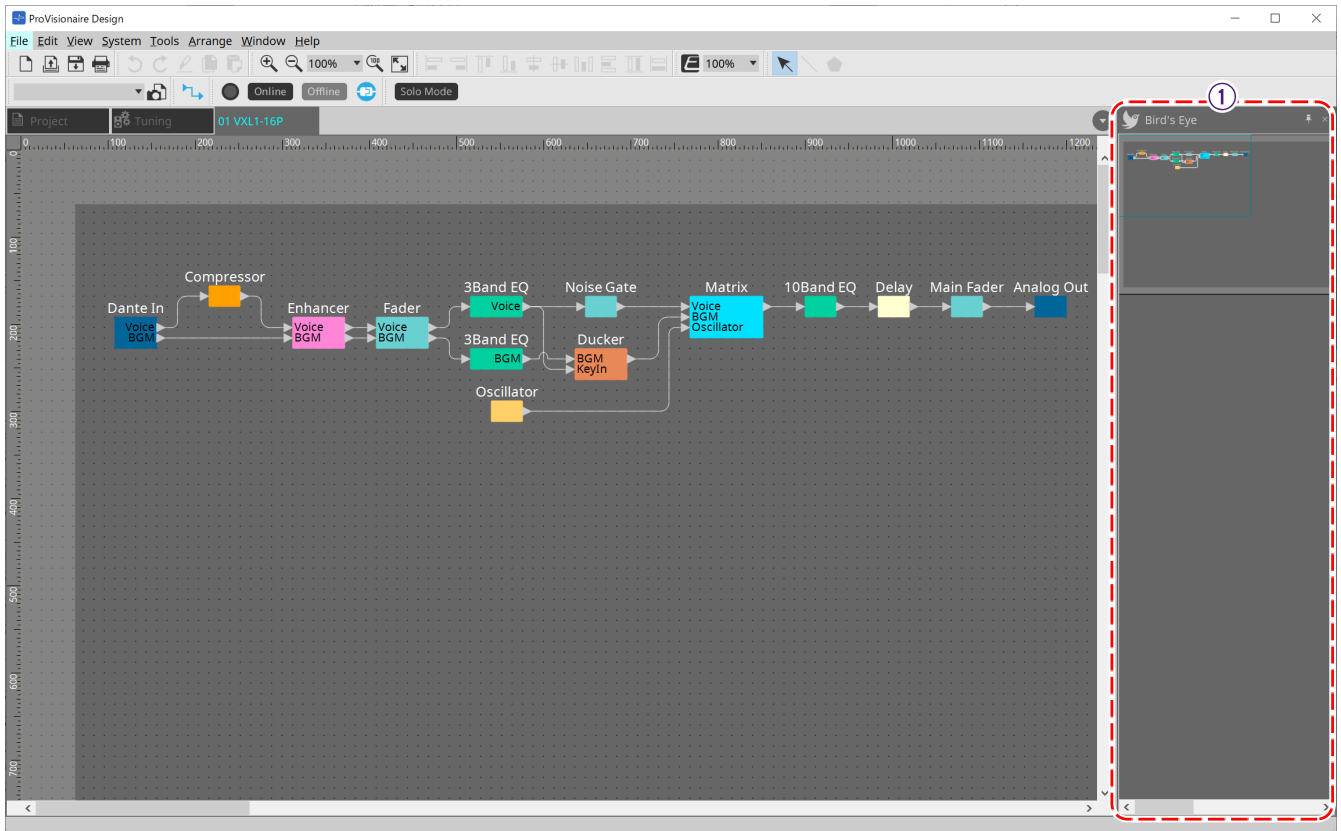

### ① Bird's Eye view

This shows an overview of the sheet.

## 22.4. Component editors

When you double-click a component in the device sheet, the component editor opens.

This section describes the VXL1-16P component editor, and the dialogs and windows that are closely associated with the components. For details about other components, refer to the ["ProVisionaire Design DME7 Component Guide"](#).

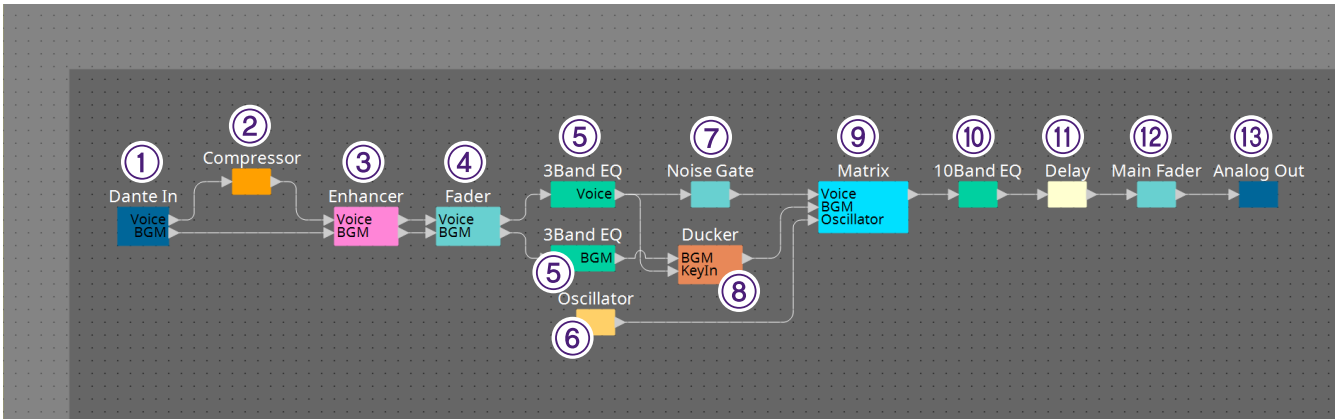

Number	Component name	Details	Link
①	Dante In	Displays the audio signal level for the 2 channels input from the [Dante] terminal and adjusts the gain.	---
②	Compressor	Adjusts the compressor that compresses dynamic range.	<a href="#">"ProVisionaire Design DME7 Component Guide"</a>
③	Enhancer	Sets whether the enhancer is enabled or disabled. This is a process that mixes in sounds beyond the low-frequency and high-frequency fundamental tones that are not output from the speakers to make it sound as if low-frequency and high-frequency sounds are being output.	---
④	Fader	Adjusts the signal level of the input channel.	---
⑤	3 Band EQ	Adjusts the 3-band equalizer of the input channel.	<a href="#">"ProVisionaire Design DME7 Component Guide"</a>
⑥	Oscillator	This outputs a sine wave used to check the operation of the connected speakers and the acoustic characteristics of the venue.	---
⑦	Noise Gate	Sets the noise gate.	---
⑧	Ducker w/NG	Sets the ducker and noise gate.	<a href="#">"ProVisionaire Design DME7 Component Guide"</a>

Number	Component name	Details	Link
⑨	Matrix	Assigns input channels and oscillator outputs to output channels.	<a href="#">"ProVisionaire Design DME7 Component Guide"</a>
⑩	10 Band EQ	Adjusts the output channel's 10-band EQ.	<a href="#">"ProVisionaire Design DME7 Component Guide"</a>
⑪	Delay	Sets the output channel delay.	<a href="#">"ProVisionaire Design DME7 Component Guide"</a>
⑫	Main Fader	Adjusts the output level.	---
⑬	Analog Out	Outputs the analog output signal to the amplifier component.	---

## 23. Microphones: PGM1

### 23.1. Overview

This is a paging microphone for use with the MRX7-D/MTX5-D. A paging system can be created using the PGM1.



Because the PGM1 settings are stored by the MRX7-D/MTX5-D, it is normally not necessary for ProVisionaire Design to discover the PGM1. When using ProVisionaire Design to change the IP address of the PGM1 or to perform a firmware update, please install Bonjour Print Service to allow ProVionaire Design to discover the PGM1.

### 23.2. "Project" sheet

When placing devices, the Settings screen shown below will be displayed.

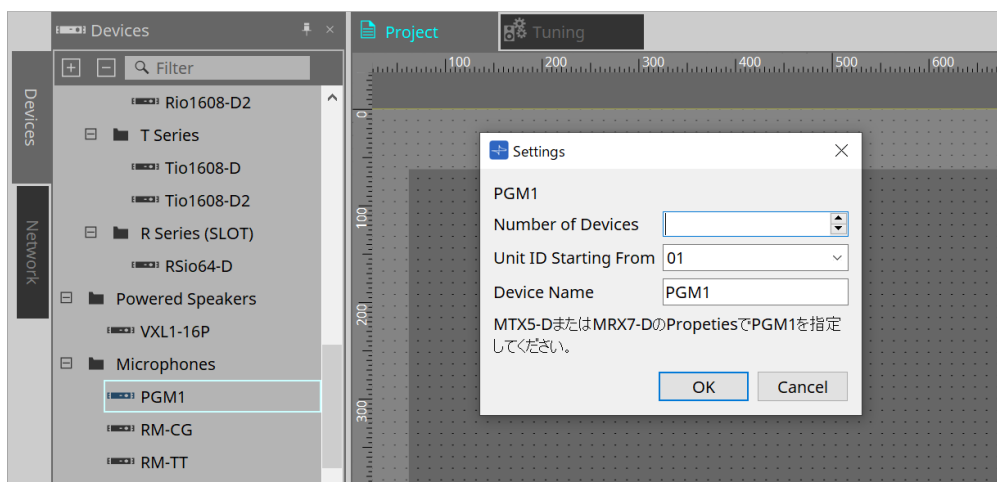

- **Number of Devices**  
Selects the number of PGM1 units placed on the sheet.
- **Unit ID Starting From**  
You can select the starting number for the device Unit IDs.
- **Device Name**  
The device name can be displayed and edited.

After adding the PGM1 to the project, select the PGM1 to be used by each device. The connection between the equipment and PGM1 is made from the "Properties" area > PGM1 on the Project sheet.

The PGM1 settings should be specified using the editor of the paging component on each device sheet. For the MTX5-D, this is launched from "Paging" in the Zone component displayed in the device sheet.

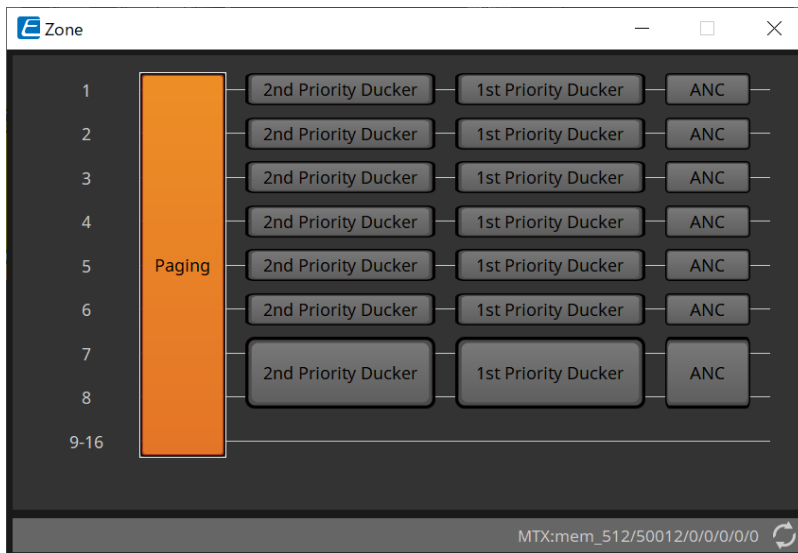

For system examples, refer to the "MTX Setup Manual."

### 23.3. "Properties" area

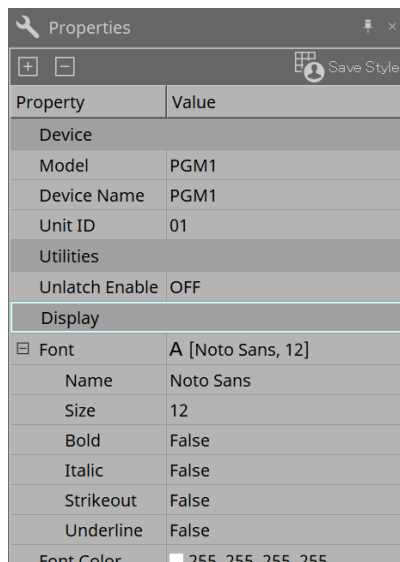

- **Utilities**

- **Unlatch Enable**

- When this is ON, the PTT button is used to both latch and unlatch.

## 24. Microphones: RM-CG

### 24.1. Overview

This will be a fixed configuration ceiling microphone.



To control "RM-CG," you must set an initial password for the device and log in.

### 24.2. "Project" sheet

When placing devices, the Settings screen shown below will be displayed.

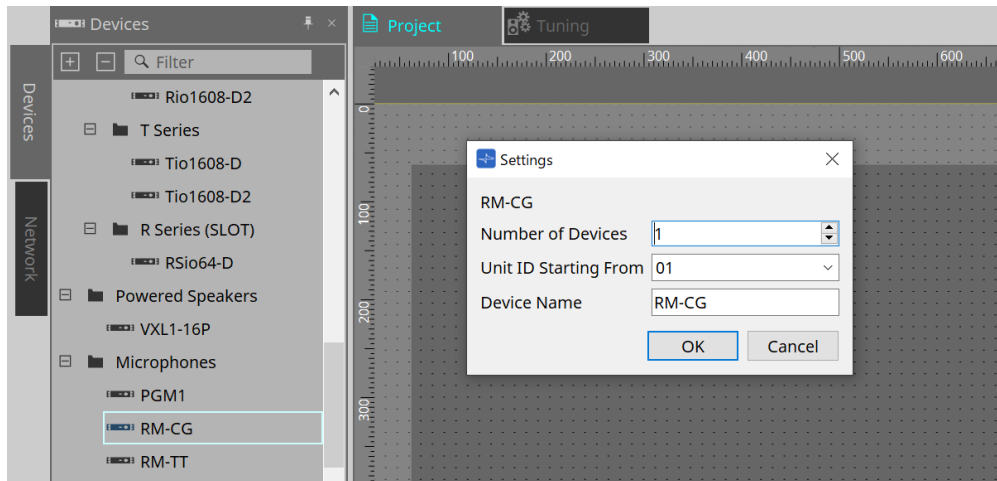

- **Number of Devices**  
Selects the number of RM-CG units placed on the sheet.
- **Unit ID Starting From**  
You can select the starting number for the device Unit IDs.
- **Device Name**  
The device name can be displayed and edited.

## 24.3. [System] menu

Settings are made in RM Series Settings, which is displayed from the [System] menu on the menu bar.

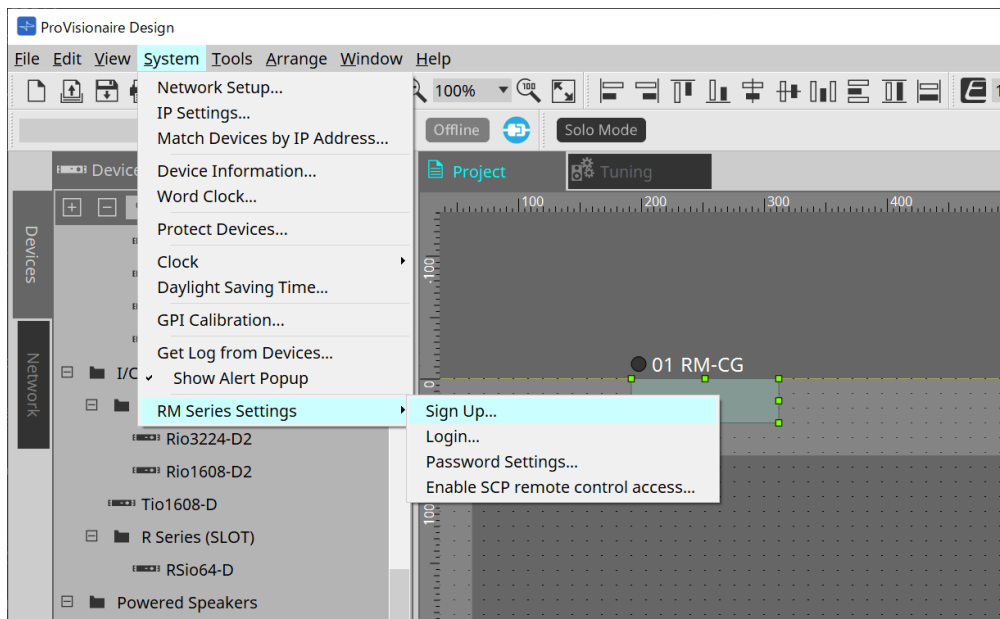

### • RM Series Settings

- **Sign Up**  
Sets the initial password.
- **Login**  
Enters the password before controlling the device with ProVisionaire Design.
- **Password Settings**  
Changes the device password.
- **Enable SCP remote control access**  
Turn this on to control devices using ProVisionaire Design or a remote control.



When the ProVisionaire Design and devices are set to online, "Enable SCP remote control access" is automatically turned on.  
After setting the devices, please reset as necessary.

## 24.4. "Network" area

To control "RM-CG," you must set an initial password for the device and log in.

Right-click on RM-CG in Network and select Sign Up/Login.

Alternately, do this in RM Series Settings, which is displayed from the [System] menu on the menu bar.

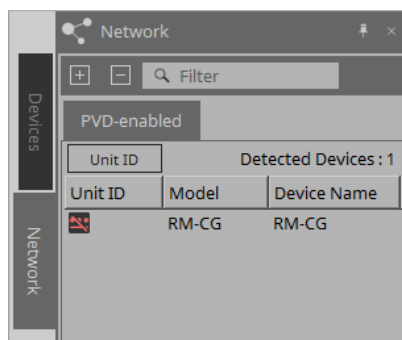



Until you login, you will not be able to configure the settings using ProVisionaire Design.

## 24.5. "Properties" area

For details, refer to the "RM-CG Reference Manual."

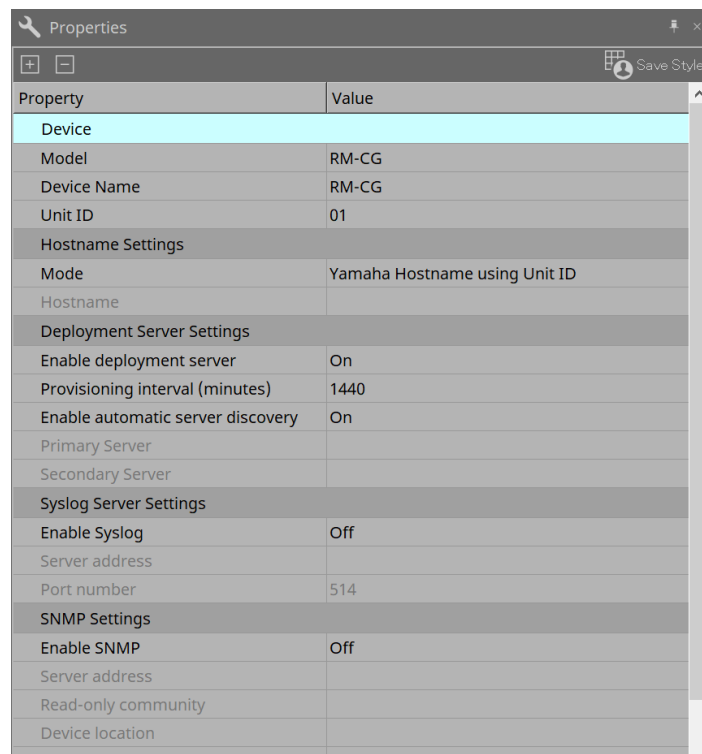

The screenshot shows a 'Properties' window with a table of configuration settings. The table has two columns: 'Property' and 'Value'. The 'Device' section is highlighted in light blue. The settings are as follows:

Property	Value
<b>Device</b>	
Model	RM-CG
Device Name	RM-CG
Unit ID	01
<b>Hostname Settings</b>	
Mode	Yamaha Hostname using Unit ID
Hostname	
<b>Deployment Server Settings</b>	
Enable deployment server	On
Provisioning interval (minutes)	1440
Enable automatic server discovery	On
Primary Server	
Secondary Server	
<b>Syslog Server Settings</b>	
Enable Syslog	Off
Server address	
Port number	514
<b>SNMP Settings</b>	
Enable SNMP	Off
Server address	
Read-only community	
Device location	
Contact name	



## 24.6. Device sheet screen configuration

When the RM-CG device sheet is opened, the device sheet and the "Bird's Eye view" will be displayed. When you double-click a component in the device sheet, the component editor opens.

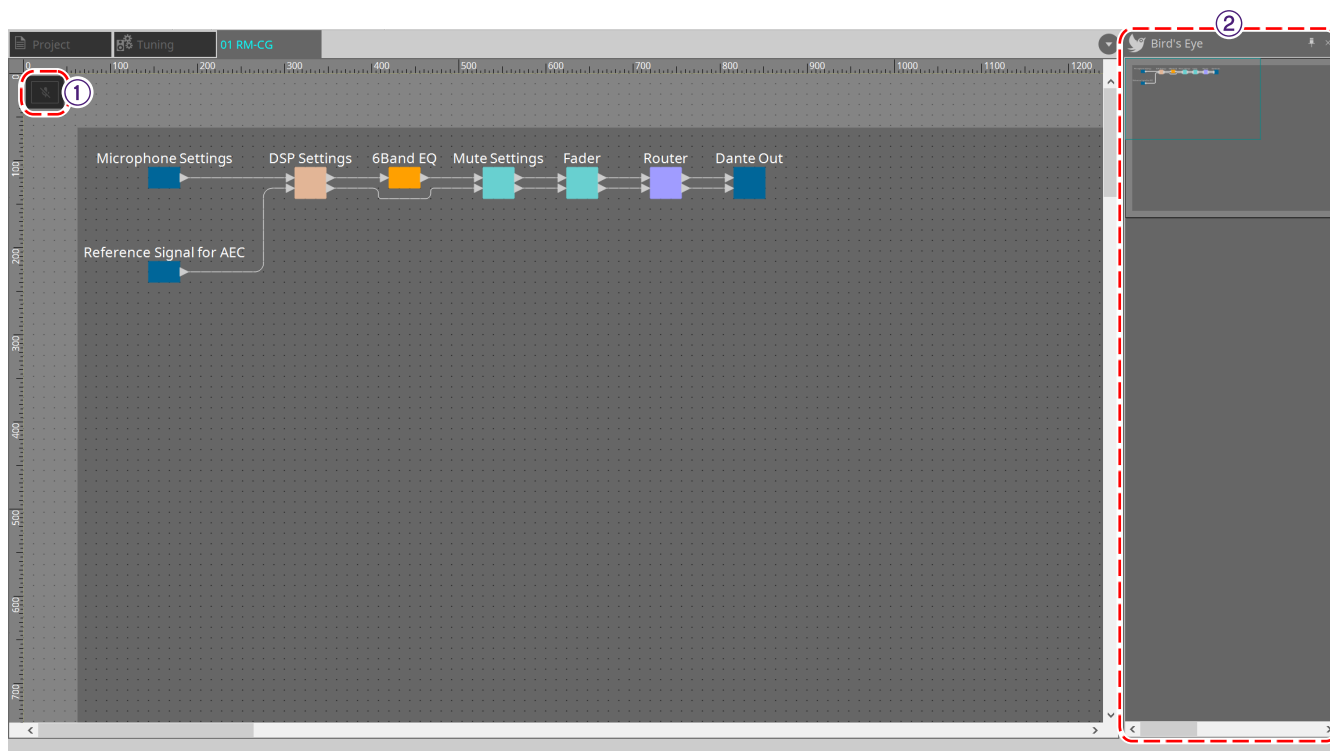

### ① Tool buttons

Frequently-used commands are provided here as buttons.

### ② Bird's Eye view

This shows an overview of the sheet.

## 24.7. Tool buttons

Frequently-used commands are provided here as buttons.

Button	Command	Overview
	Mic Mute	Mutes the microphone.

## 24.8. Component editors

When you double-click a component in the device sheet, the component editor opens.

This section describes the RM-CG component editor, and the dialogs and windows that are closely associated with the components.

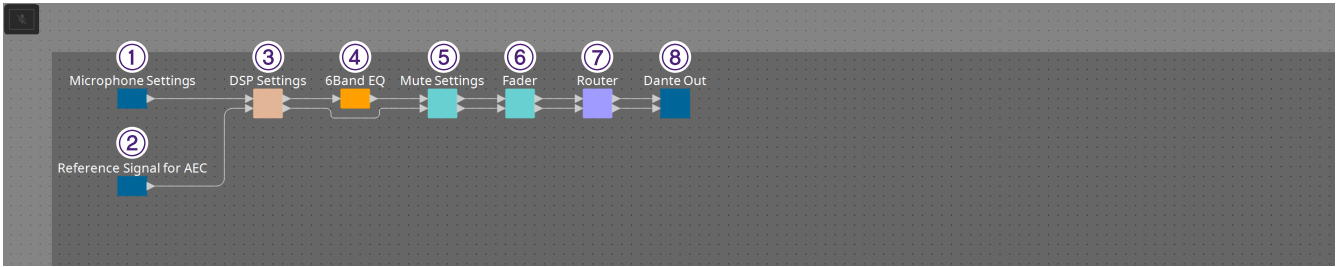

Number	Component name	Details	Link
①	Microphone Settings	This adjusts the tracking speed and range and the automixer settings.	<a href="#">"Microphone Settings" component editor</a>
②	Reference Signal for AEC	Displays the reference signal level of the adaptive echo canceller.	---
③	DSP Settings	Specifies the various DSP settings, such as adaptive echo canceller and noise reduction.	<a href="#">"DSP Settings" component editor</a>
④	6Band EQ	Adjusts the 6-band EQ.	<a href="#">"ProVisionaire Design DME7 Component Guide"</a>
⑤	Mute Setting	Sets the link to Mic Mute for each channel.	<a href="#">"Mute Settings" component editor</a>
⑥	Fader	Adjusts the audio signal level.	---
⑦	Router	Changes the assignments from input channels to output channels.	---
⑧	Dante Out	---	---

## 24.8.1. "Microphone Settings" component editor

The tracking speed and range can be checked/adjusted.  
The automixer settings can also be checked/changed.

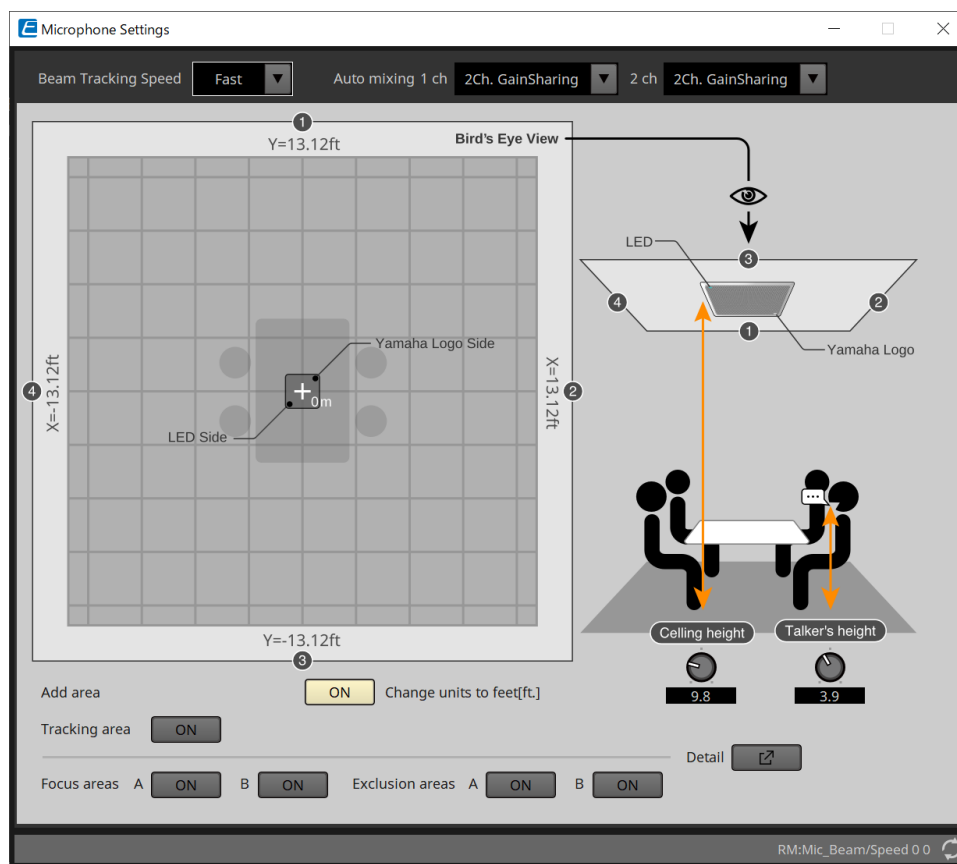

- **Beam Tracking Speed**

Set the reaction time at which the beam follows the talker.

- **Slow**  
his setting increases the stability of volume changes, but slows the talker tracking. Select this mode when the volume changes frequently due to a room with long reverberation times.
- **Fast**  
Default setting. Well-balanced setting between volume change stability and talker tracking.

- **Auto mixing**

Set the type of automatic audio mixing of microphone beam inputs.

- **1Ch.Gating**  
Select this setting for single beam mode. This provides higher clarity but more volume variation for a small group of talkers in a reverberant room with long reverberations times.
- **2Ch.GainSharing**  
Default setting. Select this setting for gainsharing of two beams. Well balanced setting between clarity and volume variation.
- **4Ch.GainSharing**  
Select this setting for gainsharing of four beams. This mode provides less volume variation with lower clarity for a more natural sound with many talkers in a good acoustical room with low reverberation times.
- **All Mix**  
Select this mode mixing of four beams. This mode provides less volume variation and clarity with the most natural sound with many talkers in a good acoustical room with low reverberation.



The Ch.1 output signal uses all signal processing, and is optimized for conference audio.  
The Ch.2 output signal is optimized for applications that require linearly processed signals or low latency.

- **Tracking area**

The beam tracking range can be restricted to within a  $\pm 4$  m (13.1 ft.) square.  
This is used to separate tracking areas in an environment with multiple RM-CGs, or to restrict the perimeter of a single RM-CG.

- **Focus areas**

A maximum of 2 focus areas can be defined, which allows the ceiling microphone to more clearly pick up speech within that specific area, even at low volumes.

This setting can be used alone or in addition to "Tracking Area."

Note that if the [Focus Area] overlaps with an [Exclusion Area], the [Exclusion Area] is prioritized and voice tracking within the overlap area is not permitted.

- **Exclusion areas**

This specifies areas to exclude sound sources such as projectors, air conditioners, and other unwanted sounds like coffee stations.

To prevent beam tracking, a maximum of two [Exclusion Area] can be set.

This setting can be used independently of the [Tracking Area] setting.

Note that if the [Exclusion Area] overlaps with a [Focus Area], the [Exclusion Area] is prioritized and beam tracking is prevented in these areas.

- **Detail button**

When this button is clicked, a screen where you can enter numerical values for area settings will open.

## 24.8.2. "DSP Settings" component editor

The following settings can also be checked/changed.

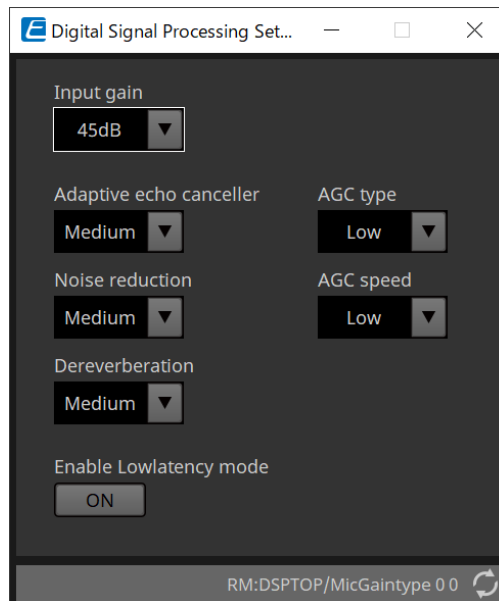

- **Input Gain**

This sets the input gain.

- **Adaptive echo canceller**

Select suppression strength of the echo canceller.

- **Off:**  
Select this to disable the internal echo canceller when using an external echo canceller of a conferencing application or an external device.
- **Low:**  
Select this setting to keep the original sound as much as possible and still suppress acoustic echo.
- **Medium:**  
Default setting. Well-balanced setting between echo cancellation strength and sound quality.
- **High:**  
Select this setting for acoustically poor rooms with high echo levels and long reverberance times.

- **Noise reduction**

Select strength of noise reduction against steady state noise.

- **Off:**  
Select this setting to disable the internal noise suppression for use with the external noise reduction of a conferencing application or an external device.
- **Low:**  
Select this setting for minimum steady state noise suppression while keeping the original sound as much as possible. This setting provides a natural room sound more than the amount of noise removed.
- **Medium:**  
Default setting. Well-balanced setting between noise suppression effects and sound quality.
- **High:**  
Select this setting for maximum steady state noise reduction in rooms with a lot of steady state noise such as loud fans or HVAC systems.

- **Dereverberation**

Select the strength of the Dereverberation function.

- 
- **Off:**  
No Dereverberation function. For use with external signal processing of a conference application or an external DSP.
  - **Low:**  
Select this setting for minimal Dereverberation for rooms with good acoustics and low reverberation times.
  - **Medium:**  
Default setting used for most rooms and is a good balance between Dereverberation and sound quality.
  - **High:**  
Select this mode for maximum Dereverberation for rooms with poor acoustics and long reverberation times. (e.g. glass walls & other reflective surfaces)
- **AGC type**  
Set strength of the auto gain control to reduce the fluctuation of the voice level, which is sent to remote listeners on the line.
    - **Off**  
Select this setting to disable automatic volume adjustment or to use another auto gain control of a conferencing application or an external device.
    - **Low**  
Default setting. Produces a natural sound level. Low talker volume input will remain low. High talker volume will be attenuated if it is too loud.
    - **High**  
Select this setting to compensate for high dynamic talker volume changes. This setting will increase the volume level of quiet talkers in the room and will attenuate volume output if it is too loud.
- **AGC speed**  
Set the reaction speed of the volume change of the auto gain control.
    - **Low:**  
Default setting and general well-balanced setting between volume change and effect.
    - **High:**  
Select this setting for faster volume level compensation.
- **Enable Low latency mode**  
Select this option for applications that require short audio delays, such as voice lifts.  
All signal processing on Ch2 (lower output of the DSP Settings component) is disabled.

### 24.8.3. "Mute Settings" component editor

Sets whether the mute status is displayed using the Status LED on the RM-CG/RM-TT main unit.

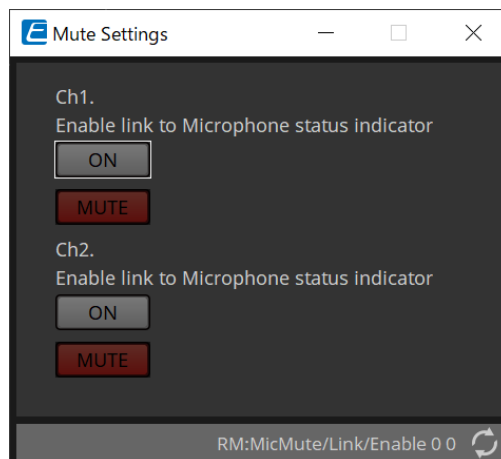

- **ON button**  
When this is ON, mutes when the main unit is muted.
- **MUTE button**  
This mutes each channel.

## 25. Microphones: RM-TT

### 25.1. Overview

This will be a fixed configuration tabletop microphone.



To control "RM-TT," you must set an initial password for the device and log in.

### 25.2. "Project" sheet

When placing devices, the Settings screen shown below will be displayed.

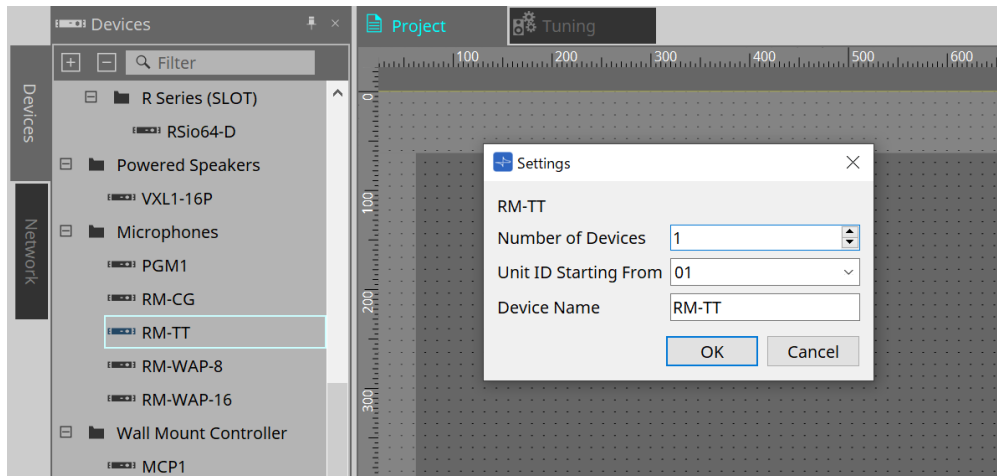

- **Number of Devices**  
Selects the number of RM-TT units placed on the sheet.
- **Unit ID Starting From**  
You can select the starting number for the device Unit IDs.
- **Device Name**  
The device name can be displayed and edited.



## 25.3. [System] menu

Settings are made in RM Series Settings, which is displayed from the [System] menu on the menu bar.

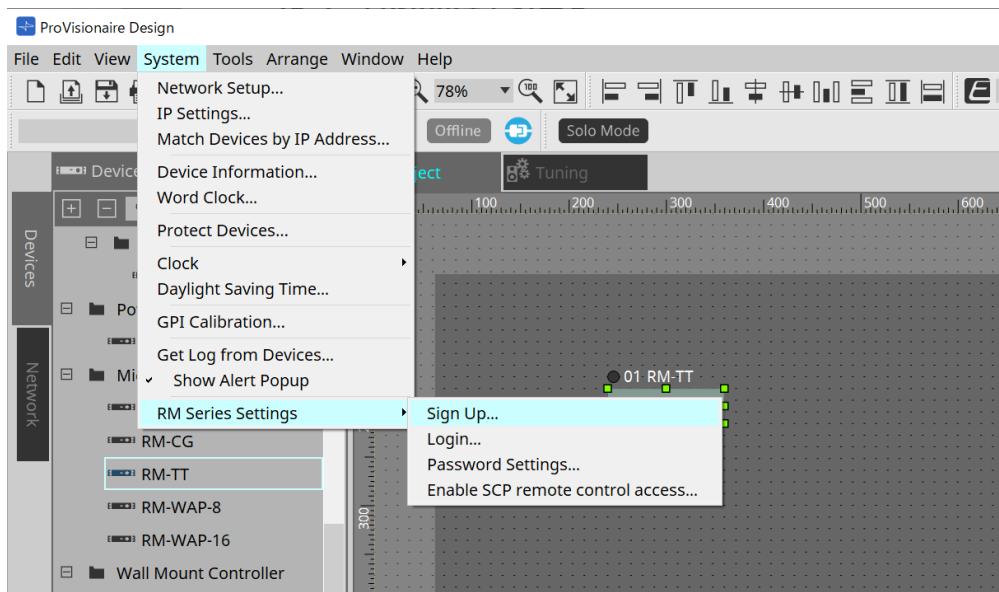

### • RM Series Settings

- **Sign Up**  
Sets the initial password.
- **Login**  
Enters the password before controlling the device with ProVisionaire Design.
- **Password Settings**  
Changes the device password.
- **Enable SCP remote control access**  
Turn this on to control devices using ProVisionaire Design or a remote control.



When the ProVisionaire Design and devices are set to online, "Enable SCP remote control access" is automatically turned on.  
After setting the devices, please reset as necessary.

## 25.4. "Network" area

To control "RM-TT," you must set an initial password for the device and log in.

Right-click on RM-TT in Network and select Sign Up/Login.

Alternately, do this in RM Series Settings, which is displayed from the [System] menu on the menu bar.

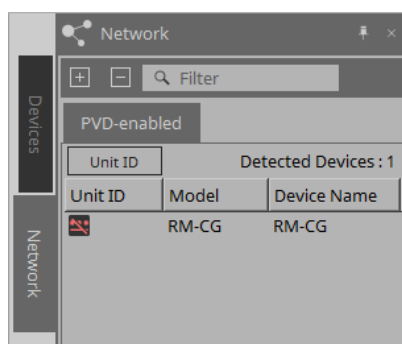

Until you login, you will not be able to configure the settings using ProVisionaire Design.

## 25.5. "Properties" area

For details, refer to the "RM-TT Reference Manual."

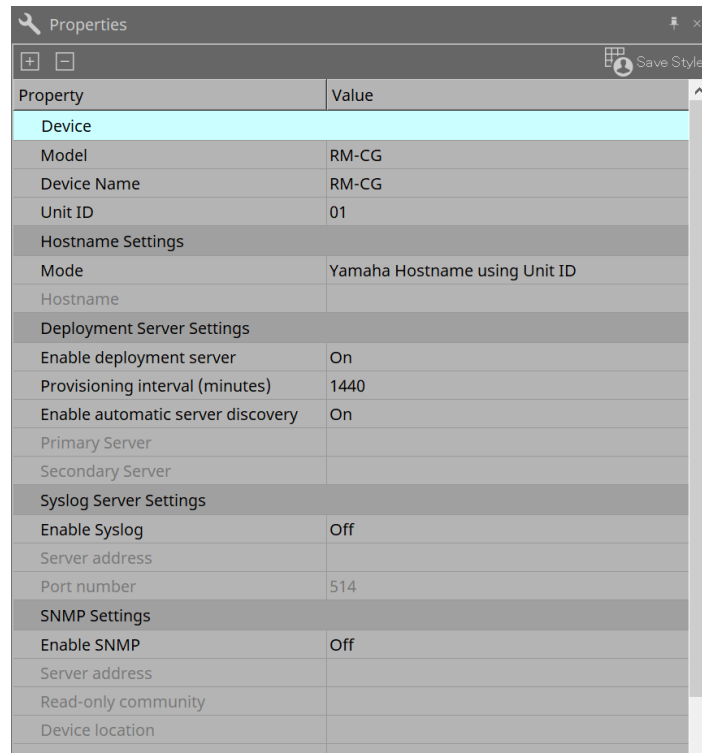

The screenshot shows a 'Properties' window with a table of settings. The table has two columns: 'Property' and 'Value'. The 'Device' row is highlighted in cyan. The settings are grouped into sections: Device, Hostname Settings, Deployment Server Settings, Syslog Server Settings, and SNMP Settings.

Property	Value
Device	
Model	RM-CG
Device Name	RM-CG
Unit ID	01
Hostname Settings	
Mode	Yamaha Hostname using Unit ID
Hostname	
Deployment Server Settings	
Enable deployment server	On
Provisioning interval (minutes)	1440
Enable automatic server discovery	On
Primary Server	
Secondary Server	
Syslog Server Settings	
Enable Syslog	Off
Server address	
Port number	514
SNMP Settings	
Enable SNMP	Off
Server address	
Read-only community	
Device location	

## 25.6. Device sheet screen configuration

When the RM-TT device sheet is opened, the device sheet and the "Bird's Eye view" will be displayed. When you double-click a component in the device sheet, the component editor opens.

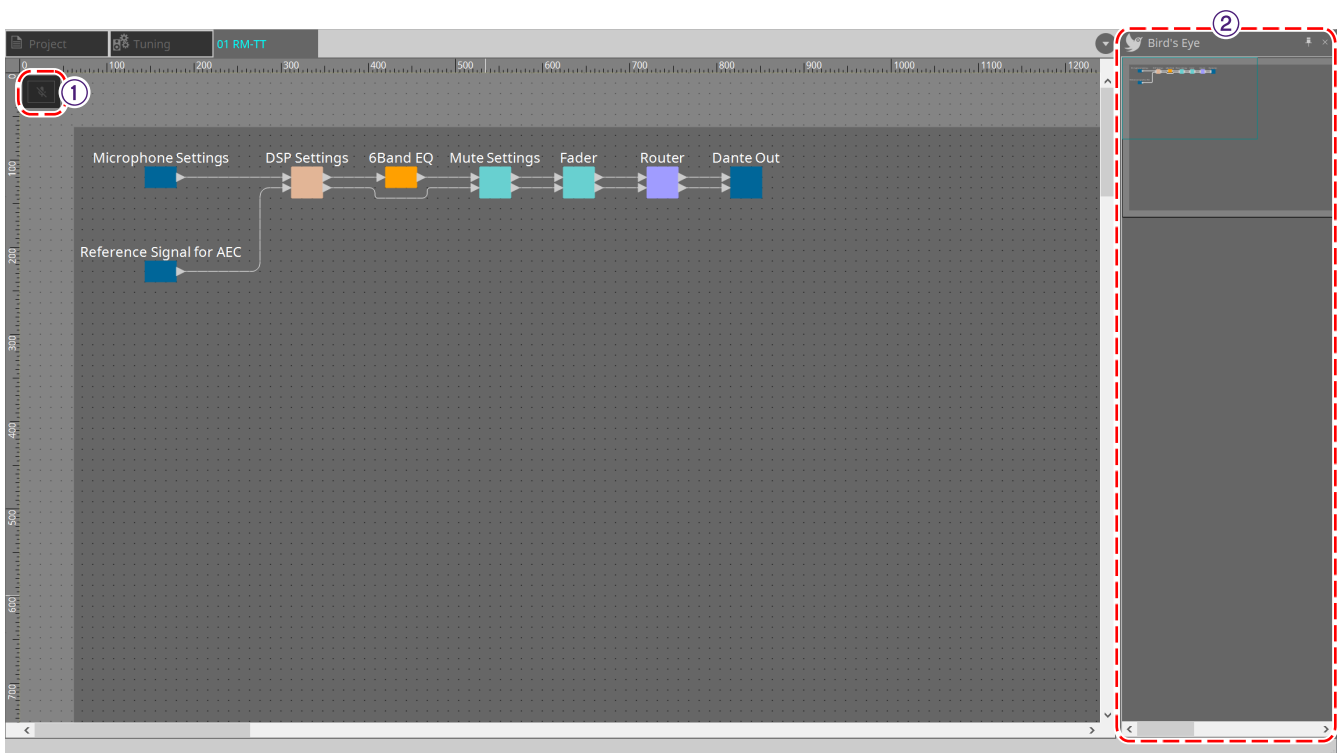

### ① Tool buttons

Frequently-used commands are provided here as buttons.

### ② Bird's Eye view

This shows an overview of the sheet.

## 25.7. Tool buttons

Frequently-used commands are provided here as buttons.

Button	Command	Summary
	Mic Mute	Mutes the microphone.

## 25.8. Component editors

When you double-click a component in the device sheet, the component editor opens.

This section describes the RM-TT component editor, and the dialogs and windows that are closely associated with the components.

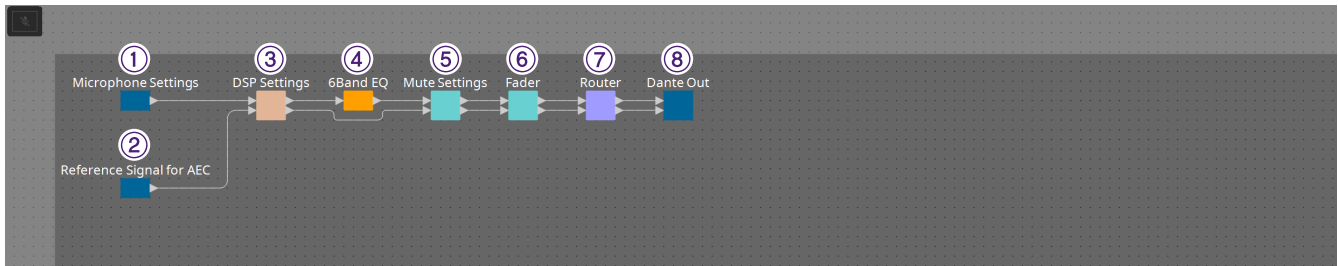

Number	Component name	Details	Link
①	Microphone Settings	Sets the mute button operation and the mic's directivity.	<a href="#">"Microphone Settings" component editor</a>
②	Reference Signal for AEC	Displays the reference signal level of the adaptive echo canceller.	---
③	DSP Settings	Specifies the various DSP settings, such as adaptive echo canceller and noise reduction.	<a href="#">"DSP Settings" component editor</a>
④	6Band EQ	Adjusts the 6-band EQ.	<a href="#">"ProVisionaire Design DME7 Component Guide"</a>
⑤	Mute Setting	Sets whether or not the mute status is displayed on the indicator on the upper screen.	<a href="#">"Mute Settings" component editor</a>
⑥	Fader	Adjusts the audio signal level.	---
⑦	Router	Changes the assignments from input channels to output channels.	---
⑧	Dante Out	---	---

## 25.8.1. "Microphone Settings" component editor

The tracking speed and range can be checked/adjusted.  
The automixer settings can also be checked/changed.

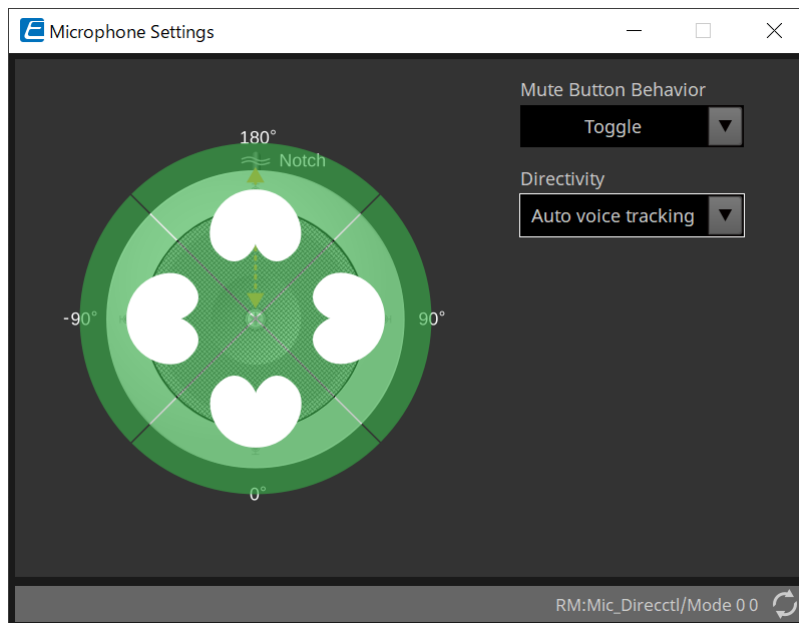

### • Mute Button Behavior

- **Toggle**  
Mute on and off will be toggled by pressing the mute button.
- **Push to talk**  
Microphone will be muted unless the button is pressed and held.
- **Disable**  
Mute button on the device is disabled and mute status can only be changed externally (controller or different microphone in same group).

### • Directivity

Sets the directivity of the microphone.

- **Auto voice tracking**  
This is the default setting. Select this setting for automatic tracking mode. The microphone automatically focuses on the voice of the person speaking.
- **Omnidirectional**  
With this setting, all microphone elements are always active. Audio is picked up in the hemisphere above the microphone. Multiple voices can be captured simultaneously using the Omni setting. This setting should only be selected for quiet rooms with no reverberation and good acoustical conditions.
- **Cardioid**  
This setting allows to select the direction of up to 4 active cardioid pick-up patterns. Select this setting if participants are always in the same location in relation to the microphone. Cardioid requires that an auto-mixing strategy is selected.
- **Supercardioid**  
Same as cardioid, but the directivity of the pick-up pattern is narrower than cardioid.
- **Hypercardioid**  
Same as cardioid and Supercardioid, but the pick-up pattern is even narrower than supercardioid.
- **Toroid**  
Select this setting in environments with noise sources above the microphone. Audio pick-up is

limited in vertical direction; the microphone focuses on voice sources horizontal to the microphone.

- **Bidirectional**

Select this setting to cover two talker positions opposite (180°) from each other.

When the microphone directivity is set to "Cardioid," "Supercardioid," or "Hypercardioid," the automixer settings can be checked/changed.

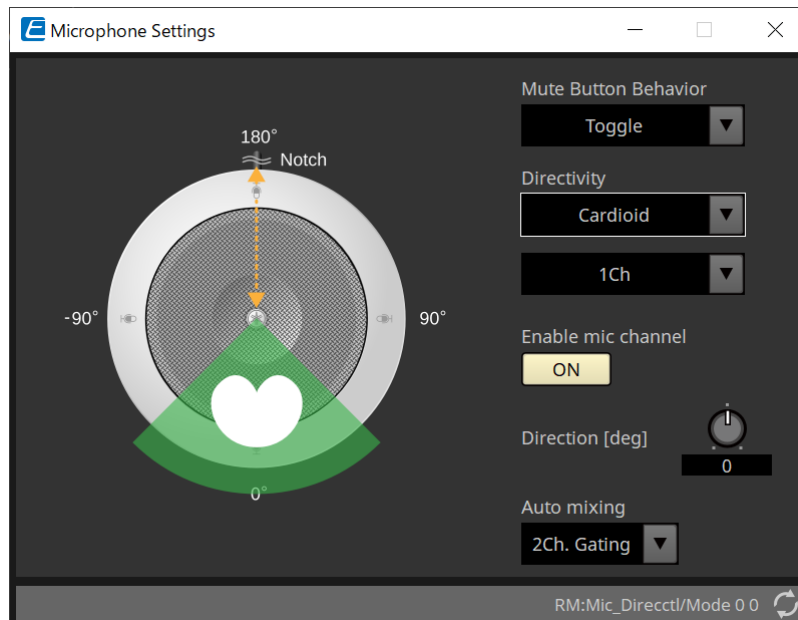

- **Enable mic channel**

Turns the microphone for the CH selected in Directivity ON or OFF.

- **Direction[deg]**

Sets/changes the acoustic angle of the microphone for the CH selected in Directivity.

- **Auto mixing**

- **1Ch. Gating**

Select this setting to allow one input channel to be active at a time. This setting provides highest clarity of the active talker, but more volume variation. Use the setting when several talkers participate in the meeting or in reverberant rooms.

- **2Ch. Gating**

Default setting. Select this setting to automatically mix up to two microphones using gain sharing. This setting allows for a well balanced experience between clarity and volume variations.

- **4Ch. Gating**

Select this setting to allow all four channels to be mixed using gainsharing. This mode provides a better volume variation experience but with less clarity. This setting is recommended for settings with several active participants in the discussion. Use the setting only in a room with good acoustics and low reverberation times.

- **All Mix**

Select this mode to mix all four channels without gain-sharing. The listener might experience more volume variation but will experience the most natural sound with many talkers. Use the setting only in a room with good acoustics and low reverberation times.

For details on components other than the "Microphone Settings" component editor, refer to "RM-CG".

## 26. External Device: Speakers

### 26.1. Overview

For speakers placed on the Project sheet, by connecting to a PC Series or other amplifier, the PC-D amplifier speaker processor can be opened.

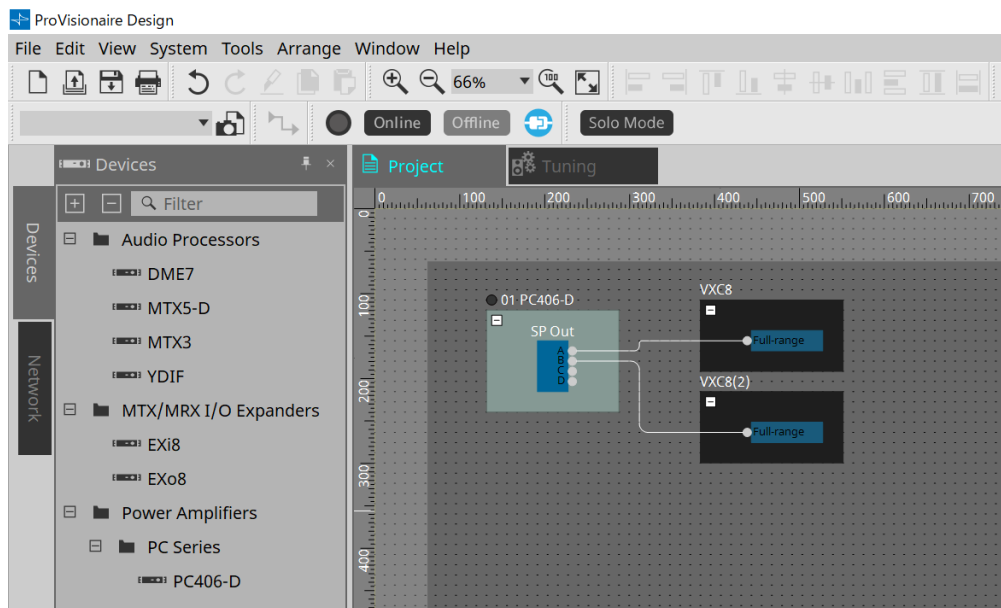

### 26.2. "Project" sheet

When placing the speaker, the Settings screen shown below is displayed.

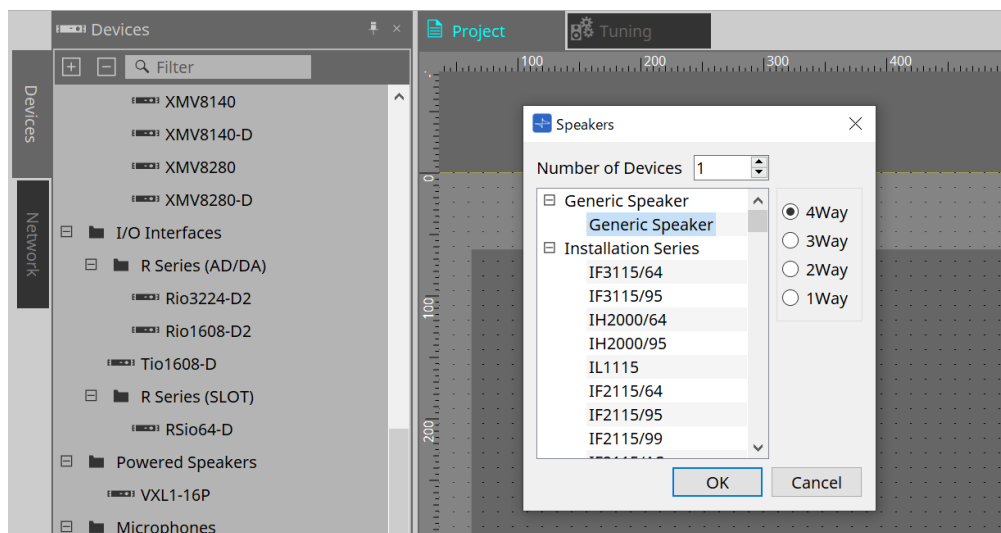

- **Number of Devices**  
Selects the number of speakers placed on the sheet.
- **[4way/3way/2way/1way] option button**  
Selects the speaker configuration.

## 26.3. "Properties" area

Displays/edits the speaker information.

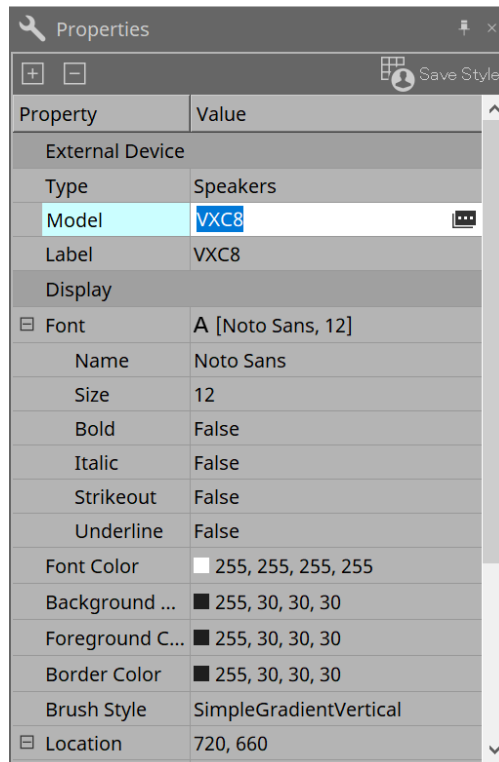

### • Model

When clicked, the  button is displayed.

 When the [image] button is clicked, the dialog is displayed, and the selected speaker type can be changed.

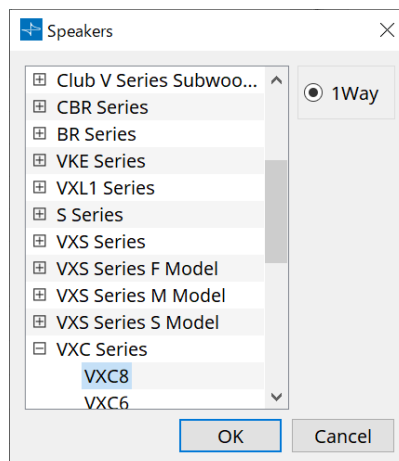

### • Label

Any text string can be displayed or edited for the speaker.



## 26.4. "Recall Speaker Preset(s)" dialog box

Here you can change the speaker library.

This dialog box appears when you right-click a speaker that is connected to a PC-series device and choose [Recall Speaker Preset(s)].

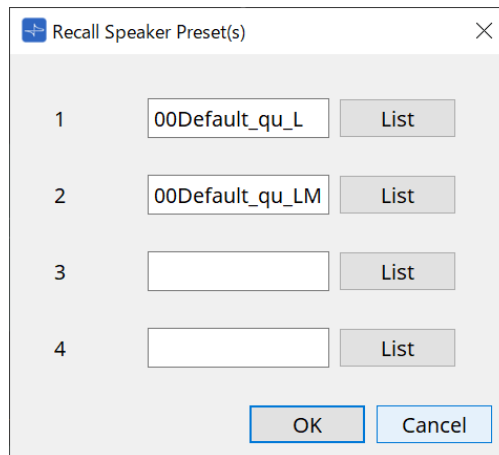

- **Library**  
For each connector, indicates the library item that is specified. Immediately after the dialog box appears, the default library item is shown.
- **[LIST] button**  
Selects and shows library items.
- **[OK] button**  
Specifies a library item and closes the dialog box.
- **[Cancel] button**  
Closes the dialog box without specifying a library item.

## 27. DCP

### 27.1. Overview

The DME7/MRX7-D/MTX5-D/MTX3 parameters can be assigned to the operators of a digital control panel (DCP) such as the DCP1V4S, and controlled from the DCP. In addition, the brightness of the LEDs on the DCP unit can be set, as well as a panel lock. Settings cannot be made while in an online state (settings can only be checked).

### 27.2. How to select the DCP to be connected

First, select DME7/MRX7-D/MTX5-D/MTX3 in the Project sheet, and select the DCP for the Properties area.

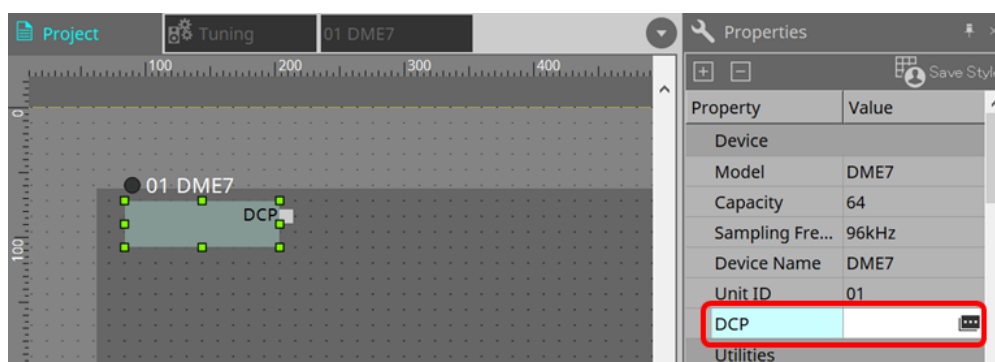

After that, use the screen below to select the DCP that has been connected to the DCP port.

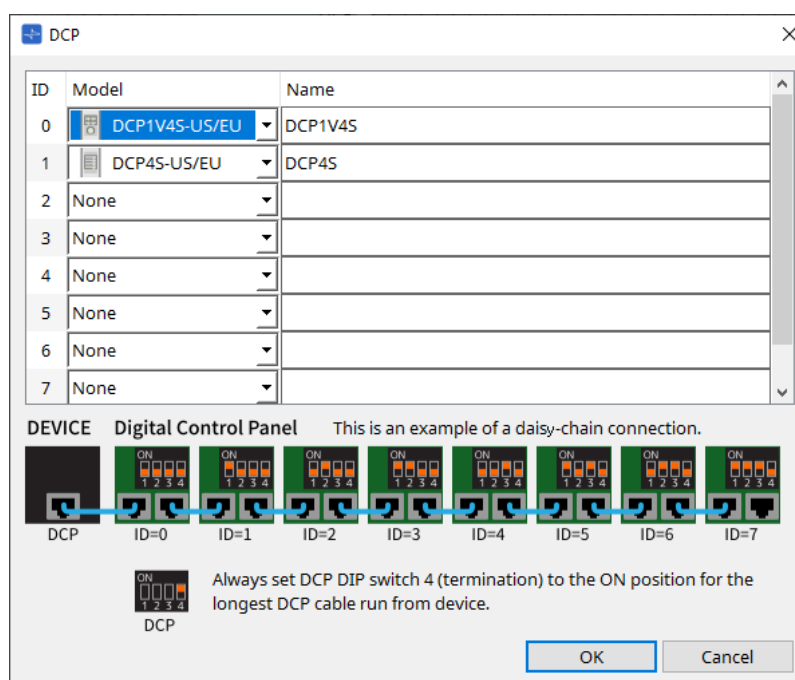

When DCP is selected, a module for DCP settings for each device on the "Project" sheet is added. Click on the DCP setting module to specify the settings.

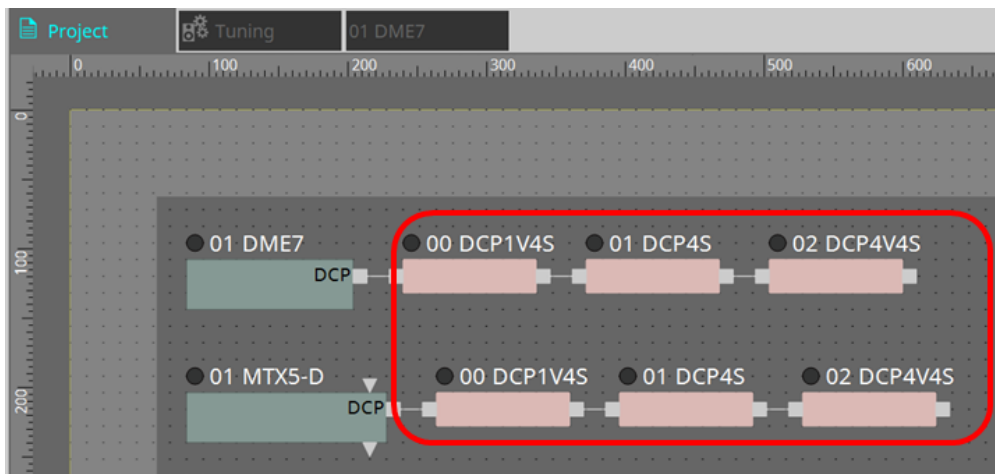

The DCP component is automatically added to the device sheet. Double-clicking a component opens the component editor.

#### ■ For the DME7/MRX7-D

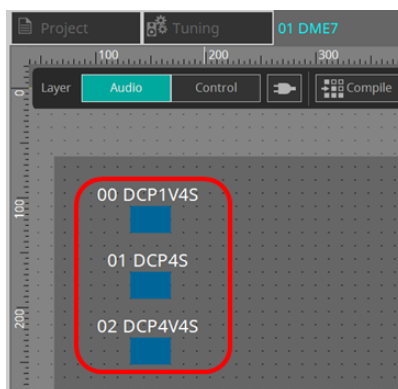

#### ■ For the MTX series

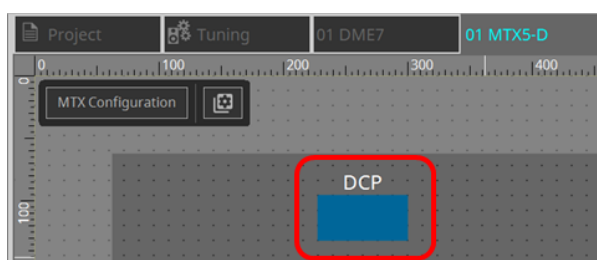

## 27.3. Setting method for DME7

A DCP component can be added to a Parameter Set just like any other audio component and store/recall its current value in a snapshot.

### ■ How to register to Parameter Set

Parameters can be registered in a parameter set in the following ways.

Registration source	Registration method
Device sheet	While holding down < Ctrl >, drag and drop the DCP component to the Parameter Set in the "Parameter Sets" area.
	Select "Add to Parameter Set" in the context menu.

### 27.3.1. DCP component setting

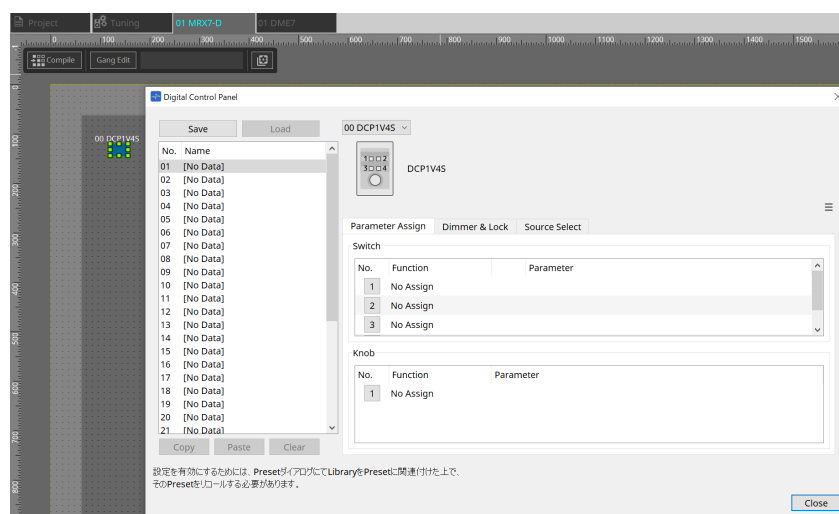

Click on the DCP component in the Audio layer and specify the various settings.

- **[Clear All] button**

Deletes the contents that have been set.

### 27.3.2. [Parameter Assign] tab

The setting dialog that is used to specify the settings for each operator is displayed when the No. icon for the operator (switch or knob) that you want to set is clicked. Assign DME7 parameters to each operator in the dialog.

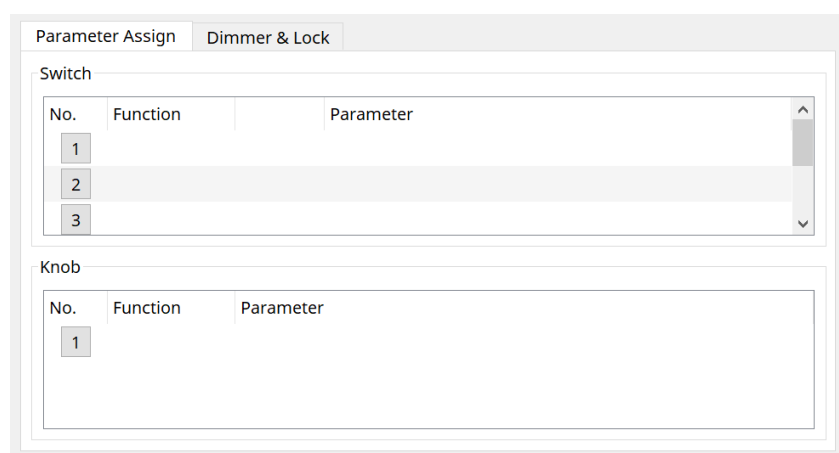

### 27.3.2.1. DCP component: Settings dialog (switch)

Click the No. icon of the DCP component editor to open it.

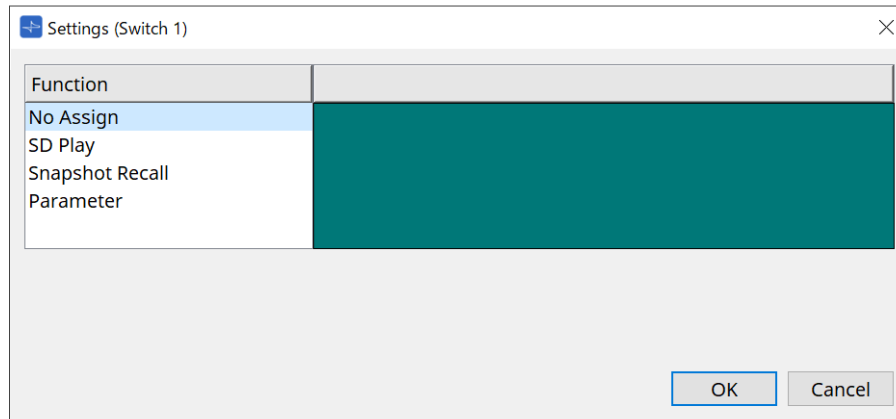
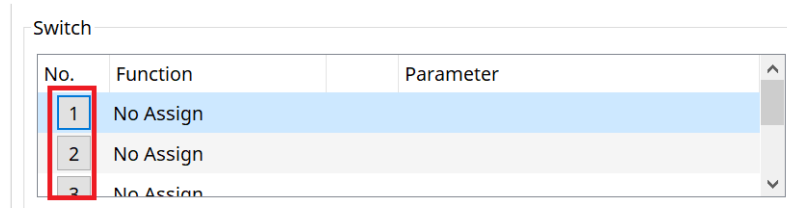

- **[OK] button**  
Saves the settings and closes the dialog box.
- **[Cancel] button**  
Closes the dialog box without saving the changes.

#### Function

- **[No Assign]**  
Function is not assigned.
- **[SD Play]**

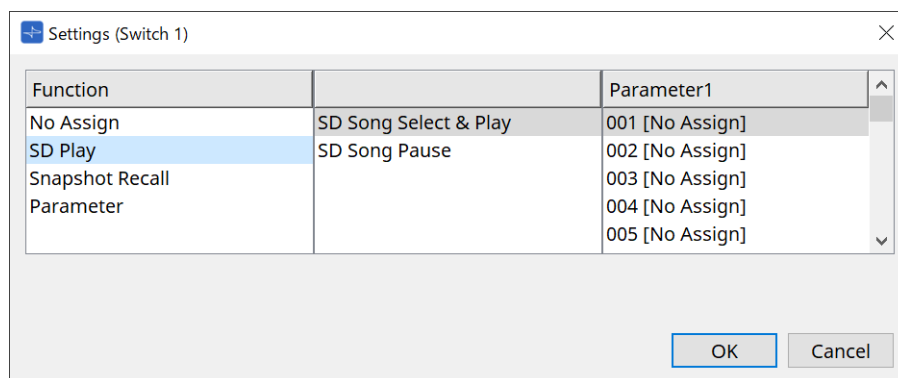

- **SD Song Select & Play**  
Plays the file specified in the [Parameter1] list.  
For SD Card file settings, refer to ["SD Card File Manager" dialog](#).
- **SD Song Pause**  
Stops playing the file.

- **[Snapshot Recall]**

Recalls the snapshot.

Snapshot can be registered in the following ways.

Registration source	Registration method
"Parameter Sets" area	Drag and drop the snapshot into the green area of the "Settings" dialog box.

- **[Parameter]**

Operate parameters with switches.

Parameters can be registered in the following ways.

Registration source	Registration method
Component editor	While pressing and holding down < Ctrl >, drag and drop a parameter to the green area of the "Settings" dialog box.
"Parameters" area	Drag and drop a parameter to the green area of the "Settings" dialog box.

Below is an example of assigning a parameter that changes continuously.

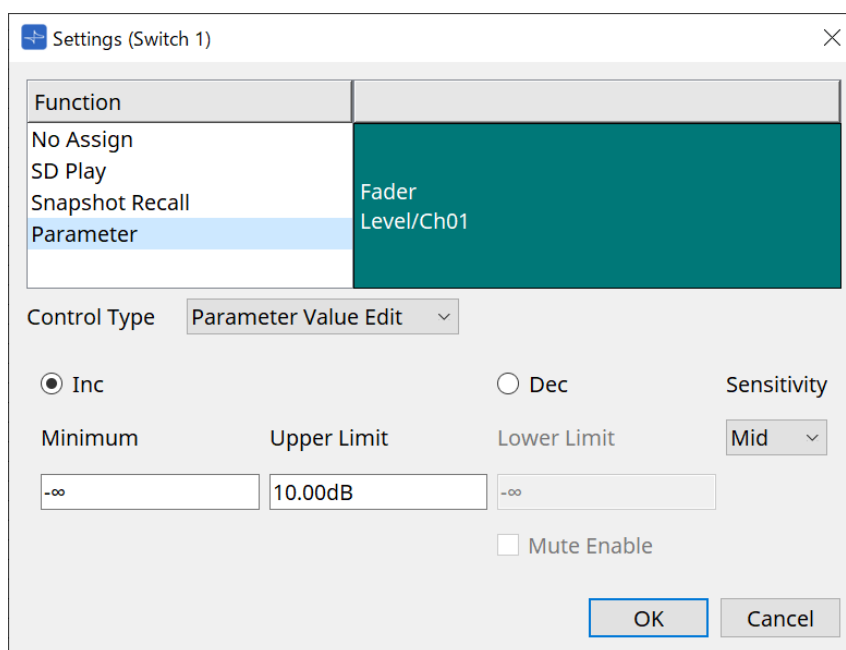

- **[Control Type] list box**

If Parameter Value Edit is selected

- **[Inc]**

The parameter is added each time the switch is pressed.

You can set the movable range with Minimum/Upper Limit.

Click Minimum/Upper Limit to display controls.

- **[Dec]**

Subtracts the parameter each time the switch is pressed.

You can set the lower limit with Lower Limit.

Click Lower Limit to display the controls.

- **[Mute Enable] check box**

If this option is selected, the Mute state ( $-\infty$  dB) will be enabled if the level is lowered below the value specified by [Lower Limit].

- **[Sensitivity] list box**

Sets the sensitivity of parameter changes in response to the downward operation of the DCP switch.

- **[Control Type] list box**

If Direct Parameter Value is selected

When the switch is pressed, the parameter becomes the value specified by Value.

- **[Control Type] list box**

If Knob Assign is selected

When the switch is pressed, you can use the knob to operate the parameter assigned to the switch.

This function is only for DCP1V4S.

For the setting, refer to the knob section.

### 27.3.2.2. DCP component: Settings dialog (knob)

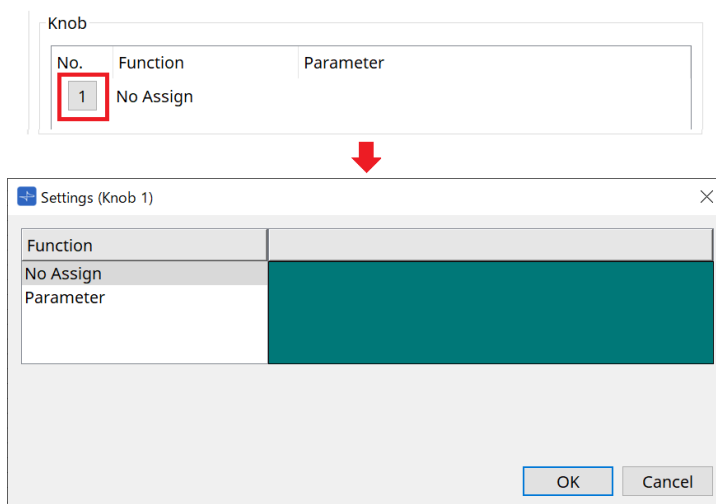

#### • [Parameter]

Operate the parameters with the knobs.

Parameters can be registered in the following ways.

Registration source	Registration method
Component Editor	While pressing and holding down < Ctrl >, drag and drop a parameter to the green area of the "Settings" dialog box.
"Parameters" area	Drag and drop a parameter to the green area of the "Settings" dialog box.

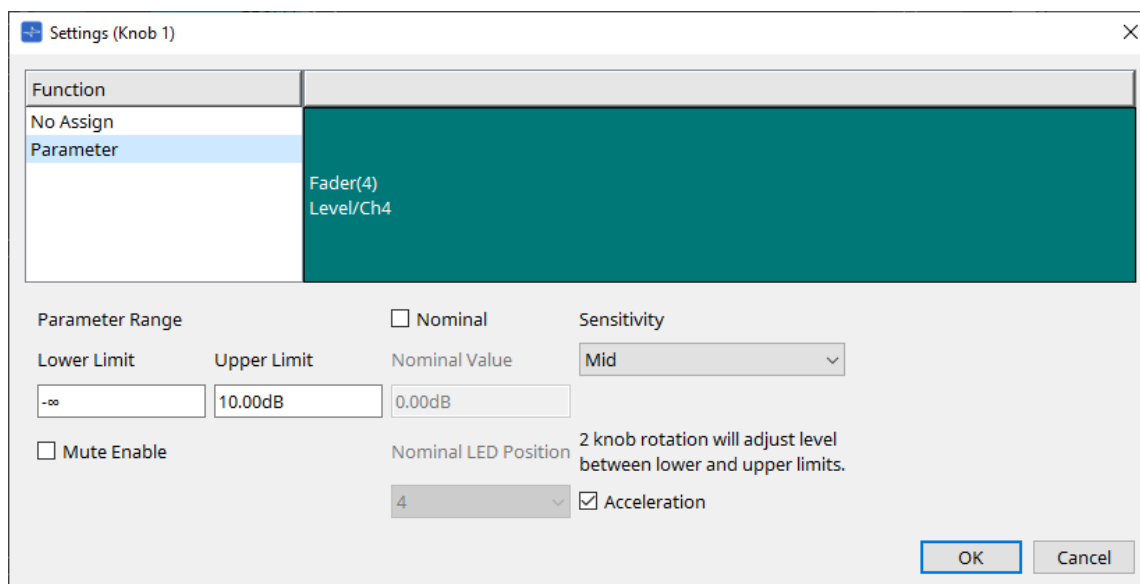

#### • [Parameter Range]

You can set the movable range with Lower Limit and Upper Limit.

Click Lower Limit/Upper Limit to display the controls.

##### ◦ [Mute Enable] check box

If this option is selected, the Mute state ( $-\infty$  dB) will be enabled if the level is lowered below the value specified by [Lower Limit].

#### • [Nominal]

By specifying the nominal value, you can assign a specific LED position as the normal volume setting. For



example by specifying the center LED as the volume setting for normal use and setting the maximum value to the maximum volume that is allowable for the system, you can prevent damage to the system that might occur if the volume of the background music were raised during a noisy time.

If the check box is selected, the Nominal function will be on.

[Nominal Value] specifies the nominal value.

[Nominal LED Position] specifies the LED position that will light when the level reaches the nominal value.

- **[Sensitivity]**

Sets the sensitivity of parameter changes in response to the rotary operation of the DCP knob.

If [Acceleration] is on, the parameter will change faster if the knob is rotated more rapidly. If [Fast] is selected as the [Sensitivity], the [Acceleration] setting is dimmed and unavailable.

### 27.3.3. [Dimmer & Lock] tab

Sets the brightness of the MCP1's display and switches, and the operation of the panel lock.

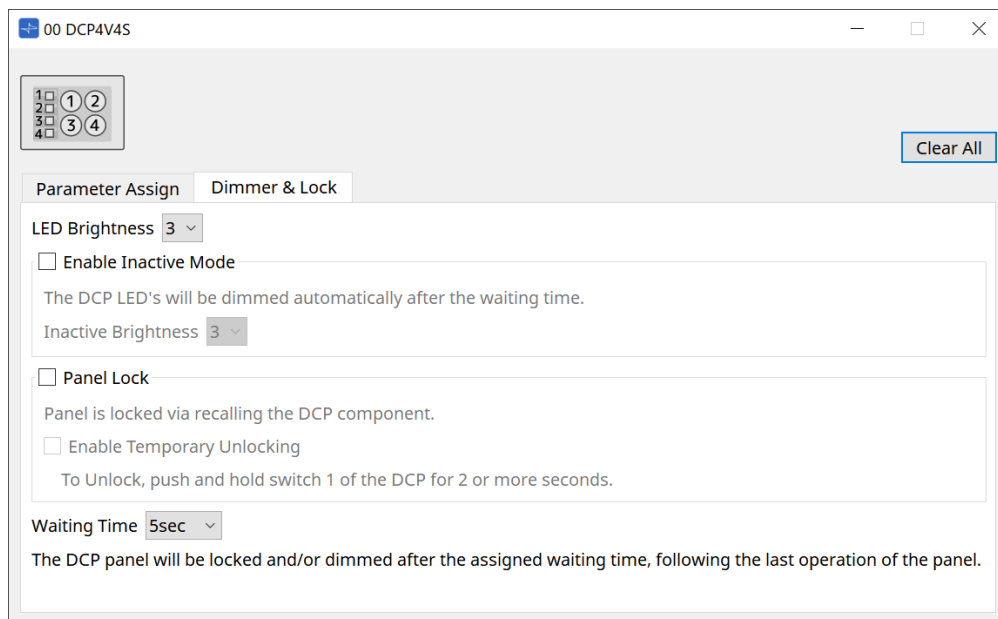

- **[LED Brightness] list box**

Specifies the brightness of the DCP unit's LEDs. Higher values will make the LEDs brighter.

- **[Enable Inactive Mode] check box**

If the check box is selected, the unit automatically enters inactive mode after a time duration specified in [Waiting Time].

[Inactive LED Brightness] specifies the brightness of the LEDs when inactive.

If the check box is cleared, the drop-down menu is grayed-out and you will be unable to set the brightness.

- **[Panel Lock] check box**

If this check box is selected, the DCP panel will be locked when the snapshot library is recalled.

If the [Enable Temporary Unlocking] check box is selected, pressing and holding down DCP switch 1 for two seconds will unlock the panel.

- **[Waiting Time]**

Specifies the time from the last operation until the unit enters inactive mode or the panel is locked.

## 27.4. Setting method for MTX5-D/MTX3

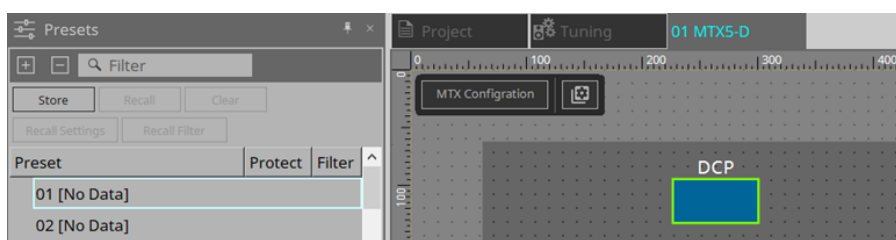

When the DCP component in MTX5-D/MTX3 is clicked, the DCP dialog opens and settings can be made.

### 27.4.1. DCP component settings

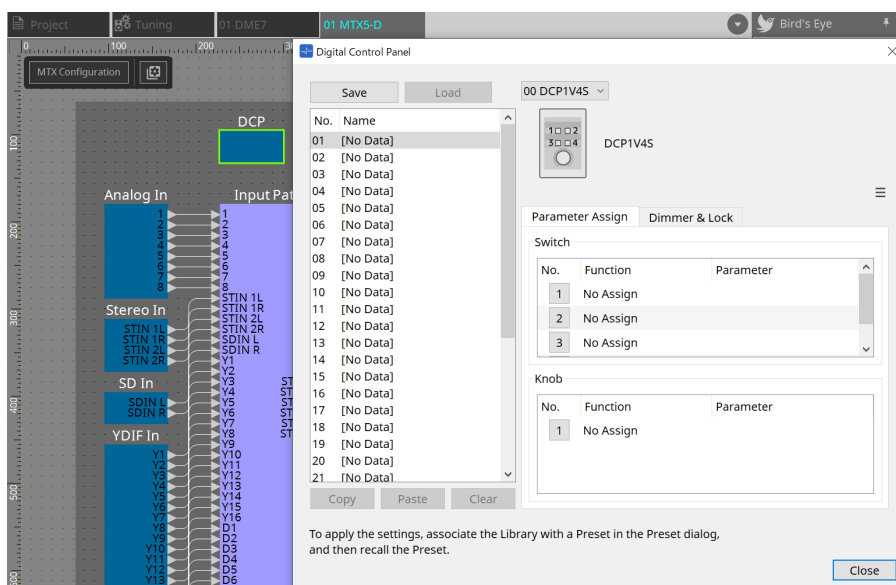

Double-click the DCP component to open the component editor.

#### • [Library]

You can store 32 sets of DCP settings in the Library.

The Library stores the settings of all DCPs connected to the MTX. Also, the DCP Library can be recalled at the same time as the MTX preset recall. Make settings in the dialog box that appears when you press the [Recall Settings] button in the "Presets" area.



The library can be used on the DCP by recalling it at the same time as the MTX preset. If you want to select the DCP to recall, click the [Recall Filter] button in the "Presets" area and make filter settings in the dialog box that appears.



Recalling the Library will collectively recall all DCPs (up to 8 units) connected to the MTX.

When recalling a Library, any desired DCP can be excluded from the recall. Click on the Recall Filter button in the Presets area and set the filter in the dialog that appears.

#### ◦ [Save] button

This button stores an item in the library.

The [Parameter Assign] tab and [Dimmer & Lock] tab settings will be saved.

#### ◦ [Load] button

Load Library.

Expand the settings to the "Parameter Assign" tab and the "Dimmer & Lock" tab.

- **[Library] list**  
Select the library item that you want to save or load. The currently-loaded library item is shown in bold characters.  
By double-clicking a previously-saved library item, you can edit its name.
- **[Copy] button**  
This button copies the selected library item.  
The Copy command is not available while online.
- **[Paste] button**  
This button pastes the copied library item to the library item that's currently selected in the list. The Paste command is not available while online.
- **[Clear] button**  
This button clears the contents of the library item that's currently selected in the list. The Clear command is not available while online.

- **DCP selection box**

Select the DCP unit for which you want to make settings.

The DCP set in the "Properties" area of the "Project" sheet will be displayed.

- **[Parameter Assign] tab**

No.	Function	Parameter
1	No Assign	
2	No Assign	
3	No Assign	

  

No.	Function	Parameter
1	No Assign	

The setting dialog that is used to specify the settings for each operator is displayed when the No. icon for the operator (switch or knob) that you want to set is clicked. Assign MTX parameters to each operator in the dialog.

## 27.4.2. DCP component: Settings dialog (switch)

Click the No. icon of the DCP component editor to open it.

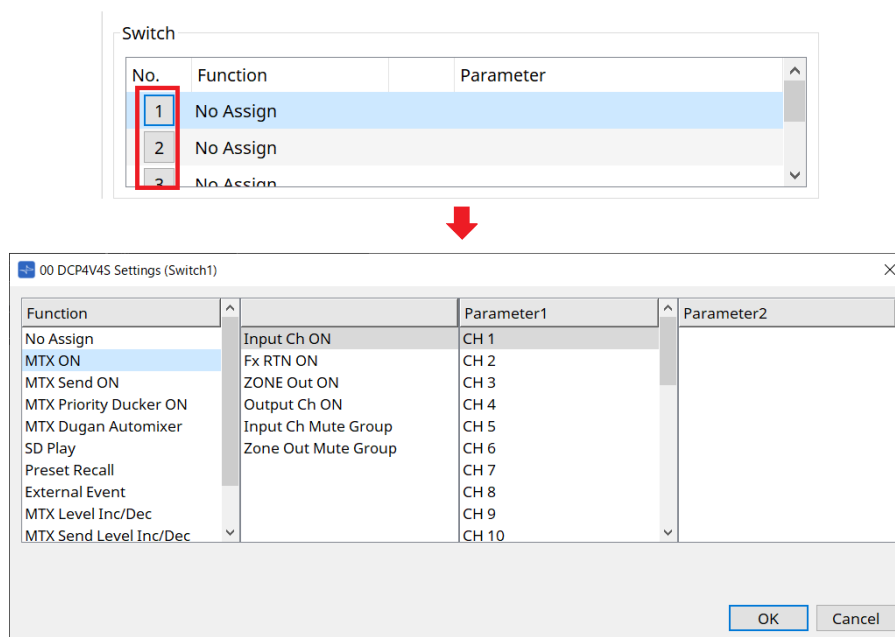

### Function

- **[No Assign]**  
Function is not assigned.
- **[MTX ON / MTX Send ON / MTX Priority Ducker ON / MTX Dugan Automixer]**

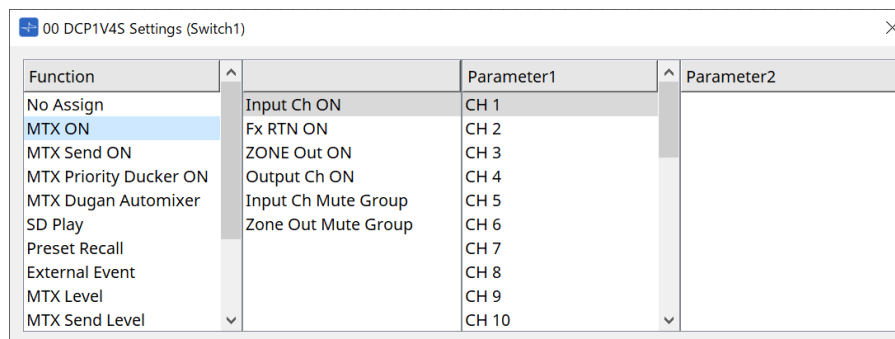

Press the switch to operate the assigned parameter.

- **[SD Play]**

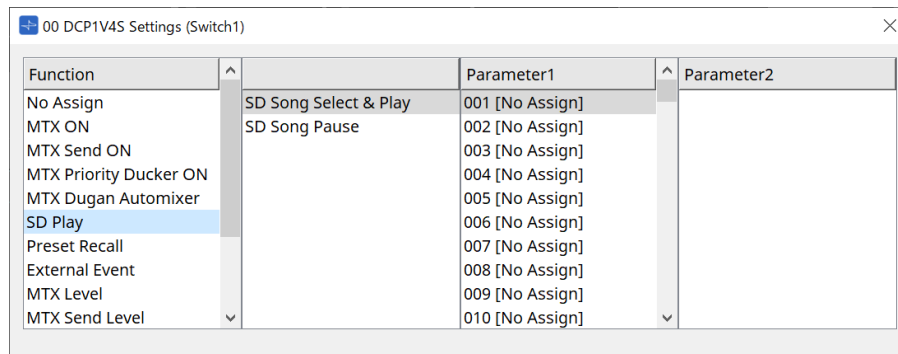

- **SD Song Select & Play**

Plays the file specified in the [Parameter1] list.

Refer to "[SD Card File Manager](#)" dialog box for playback file settings.

- **SD Song Pause**

Press the switch to stop the file being played.

- **[Preset Recall]**

Pressing the switch recalls the selected preset.

- **[External Event]**

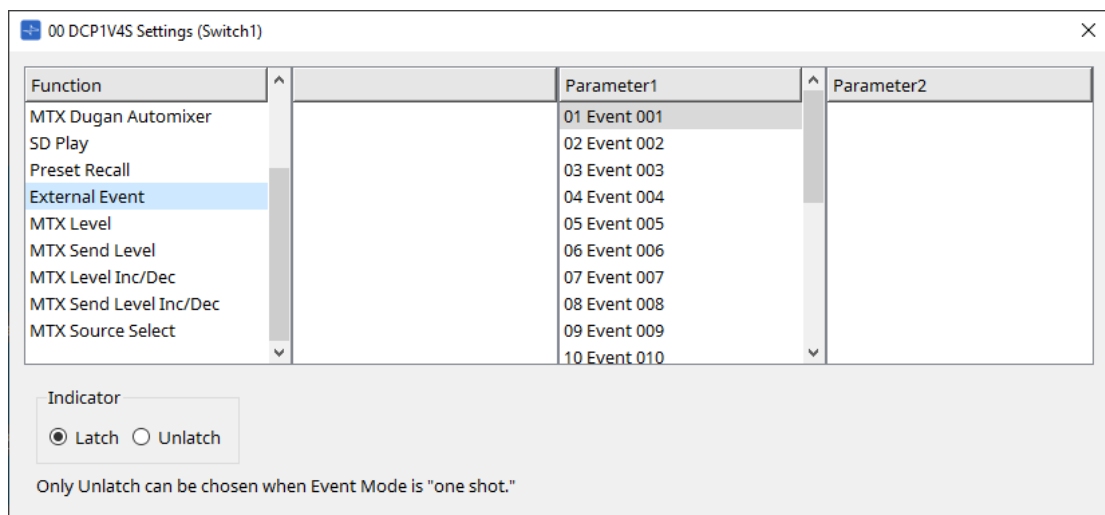

Press the switch to issue the selected event.

Set [External Event] to "[External Events](#)" dialog box.

- **[Indicator]**

Select whether the switch indicator will display the on/off status (Latch), or light only when the switch is pressed (Unlatch).

## [MTX Level / MTX Send Level]

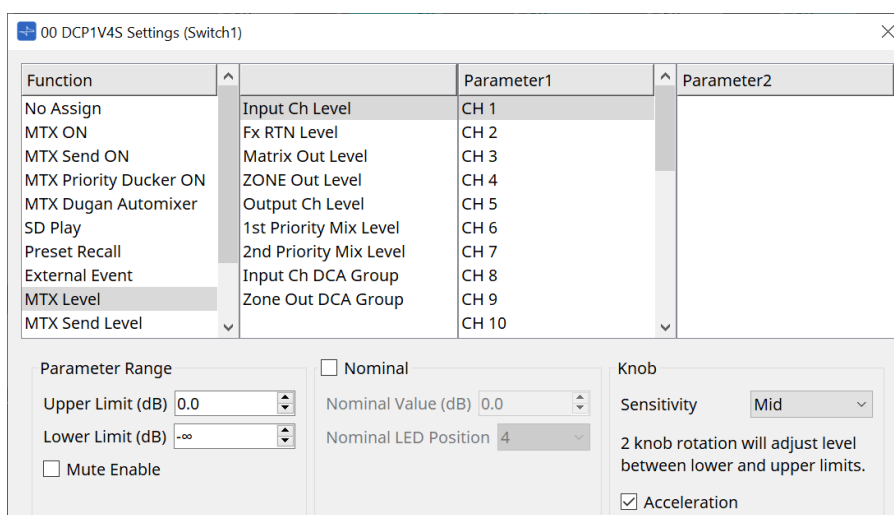

When you press the switch, the assigned parameter is automatically assigned to the knob and can be operated with the knob.

This function is only for DCP1V4S.

If you assign this to a switch, the knob will say "Occupied by sw" and will not be assignable to any other parameter. Refer to the Knob section for parameters.

## [MTX Level Inc/Dec / MTX Send Level Inc/Dec]

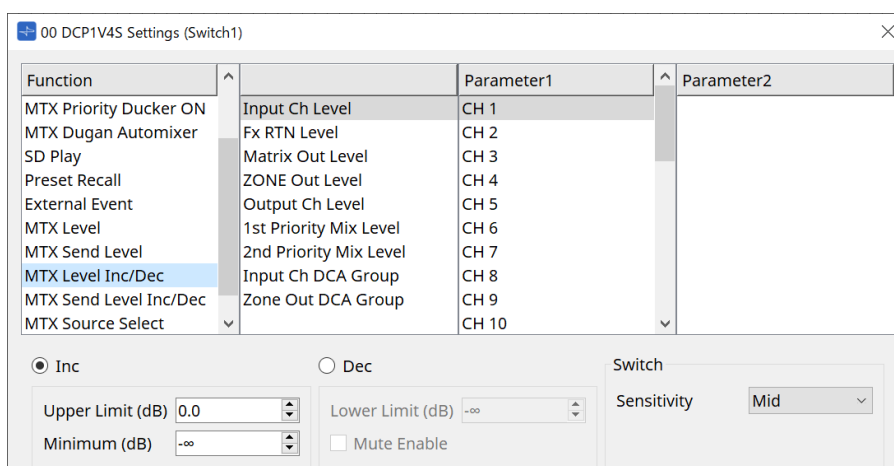

- **[Inc]**

If this is selected, the value increases when the switch is pushed. You can set the movable range with Upper Limit/Minimum.

- **[Dec]**

If this is selected, the value decreases when the switch is pushed. You can set the lower limit with Lower Limit.

- **[Mute Enable] check box**

If this option is selected, the Mute state ( $-\infty$  dB) will be enabled if the level is lowered below the value specified by [Lower Limit].

- **[Sensitivity] list box**

Sets the sensitivity of parameter changes in response to the downward operation of the DCP switch.

**[MTX Source Select]**

This is a source select function that uses the Matrix Mixer component.

Use Input Ch Send ON in combination with Input Ch Send Level.

Specify the send level to be controlled by the switch to which Input Ch Send ON is assigned, and operate that send level with the knob or switch to which Input Ch Send Level is assigned.

**Input Ch Send ON**

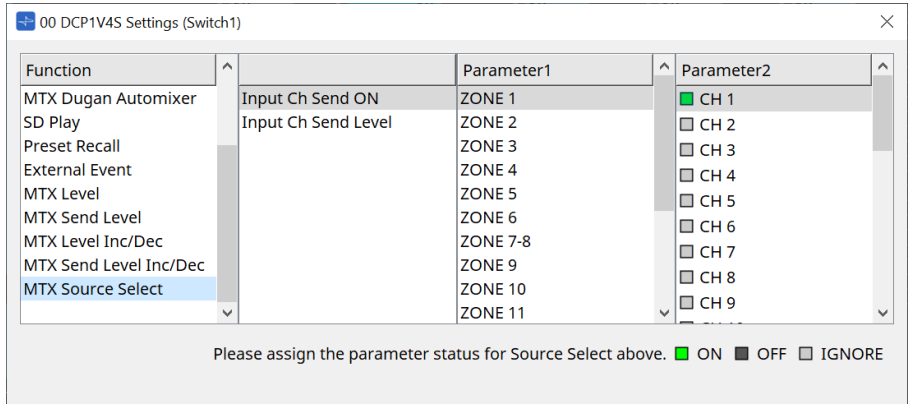

Changes the source (Parameter2) on/off for any output (Parameter1) of the Matrix Mixer component at once. Parameter2 changes its state to "ON", "OFF", and "IGNORE" each time the checkbox is clicked. Only one source can be turned "ON".

Example:

Assign DCP4V4S switches 1 and 2 to [MTX Source Select] > Input Ch Send ON, and knob 1 to [MTX Source Select] > Input Ch Send Level.

They all select the same output (Parameter1).

DCP4V4S

	function	Parameter1	Parameter2				
			CH1	CH2	CH3	CH4	CH5
Sw1	[MTX Source Select] > Input Ch Send ON	ZONE1	ON	OFF	OFF	IGNORE	IGNORE
Sw2	[MTX Source Select] > Input Ch Send ON	ZONE1	OFF	ON	OFF	IGNORE	IGNORE
Knob1	[MTX Source Select] > Input Ch Send Level	ZONE1					

ON ● (green)  
OFF ● (black)  
IGNORE ● (grey)

If switch 1 is pressed, the send level of CH1 for zone 1 is assigned to knob 1.

State when Sw1 is pressed

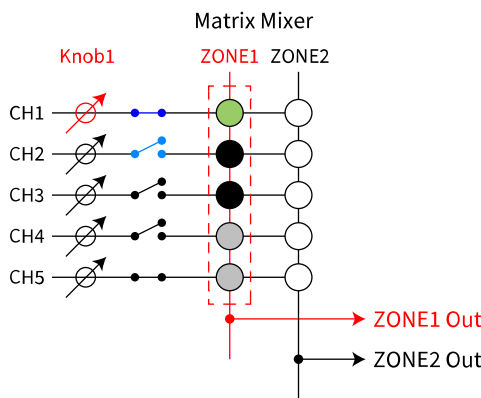

If switch 2 is pressed, knob 1 changes to CH2 send level for zone 1.

State when **Sw2** is pressed  
The parameter assigned to **Knob1** changes automatically

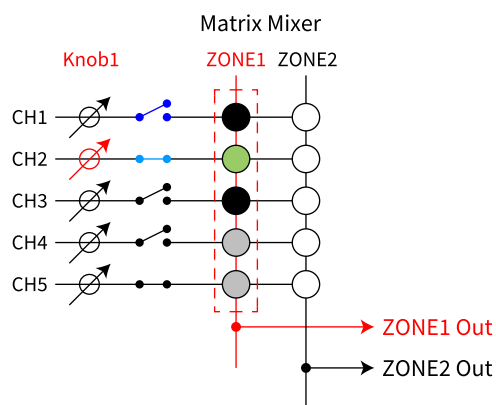

Since the switch automatically changes the send level assigned to the knob, you can control the send level of multiple points with a single knob.

### Input Ch Send Level

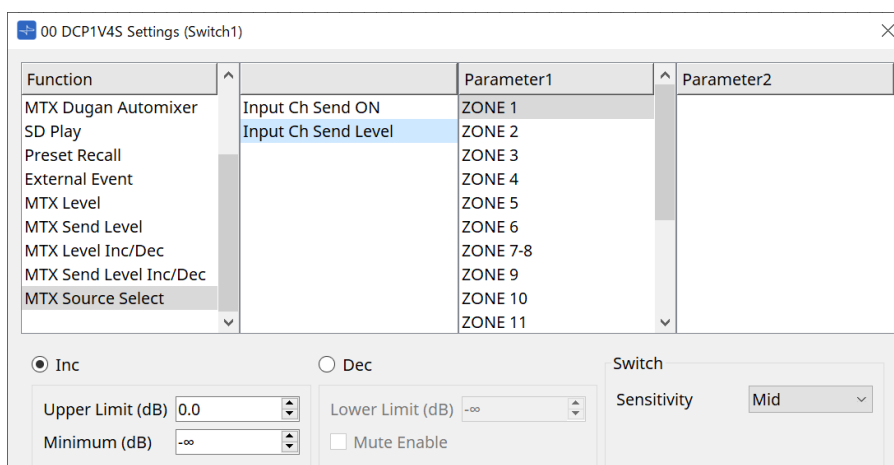

Select the output (Parameter1) of the Matrix Mixer component.

For usage, refer to [MTX Source Select] in the DCP component: Settings dialog (switch).

For parameters, refer to [MTX Level Inc/Dec/MTX Send Level Inc/Dec].



### 27.4.3. DCP component: Settings dialog (knob)

Click the No. icon of the DCP component editor to open it.

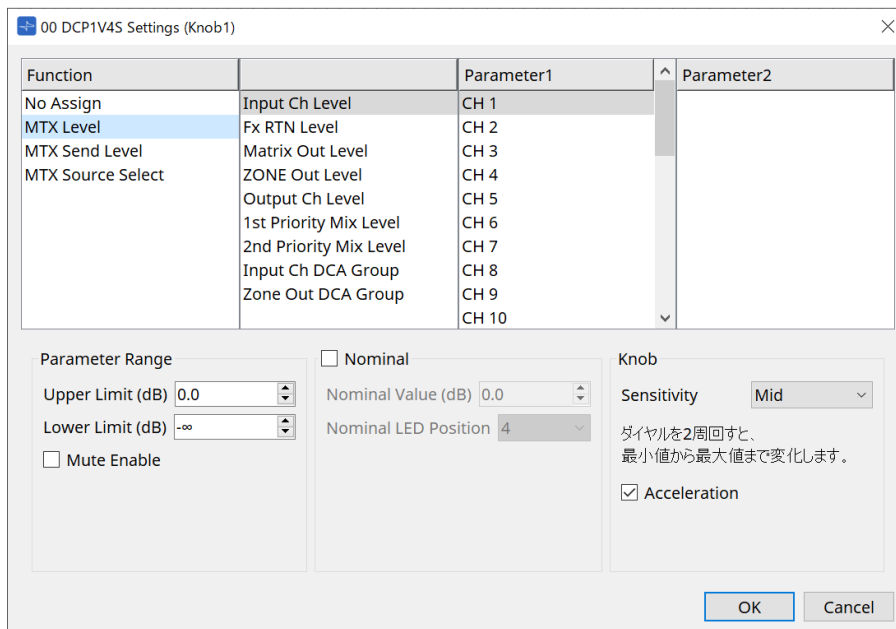
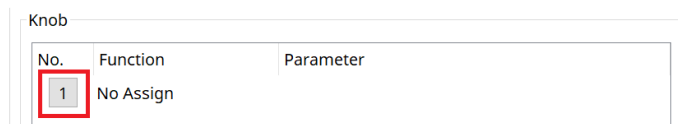

#### Function

- **[No Assign]**  
Function is not assigned.
- **[MTX Level / MTX Send Level]**

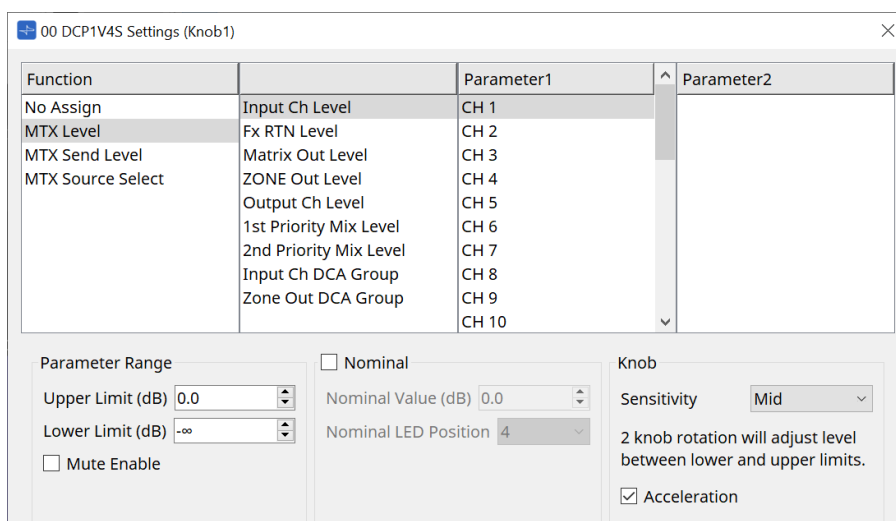

- **[Parameter Range]**  
Use [Upper Limit] and [Lower Limit] to specify the range in which the level can be varied.
  - **[Mute Enable]**  
If [Mute Enable] is on, the Mute state (-∞ dB) will be enabled if the level is lowered below the value specified by [Lower Limit].

- **[Nominal]**

Here you can make settings for the Nominal function.

By specifying the nominal value, you can assign a specific LED position as the normal volume setting. For example by specifying the center LED as the volume setting for normal use and setting the maximum value to the maximum volume that is allowable for the system, you can prevent damage to the system that might occur if the volume of the background music were raised during a noisy time.

If the check box is selected, the Nominal function will be on.

[Nominal Value] specifies the nominal value.

[Nominal LED Position] specifies the LED position that will light when the level reaches the nominal value. If the check box is cleared (Nominal function off), both parameters will be grayedout and unavailable.

- **[Sensitivity] list box**

Sets the sensitivity of parameter changes in response to the rotary operation of the DCP knob.

If [Acceleration] is on, the parameter will change faster if the knob is rotated more rapidly. If [Fast] is selected as the [Sensitivity], the [Acceleration] setting is dimmed and unavailable.

- **[MTX Source Select]**

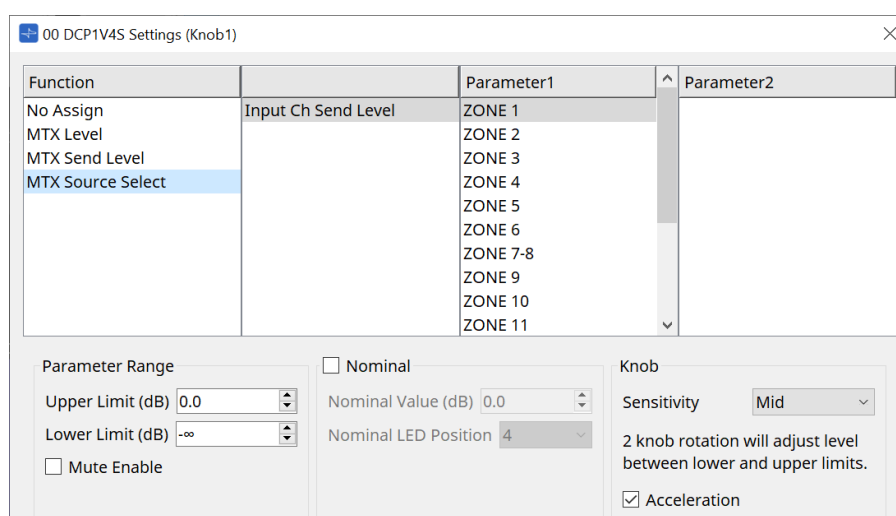

For usage, refer to [MTX Source Select] in the DCP component: Settings dialog (switch).

For parameters, refer to [MTX Level / MTX Send Level].

- **[Dimmer & Lock] tab**

This sets the brightness of the LEDs on the DCP unit and the settings for the resting state.

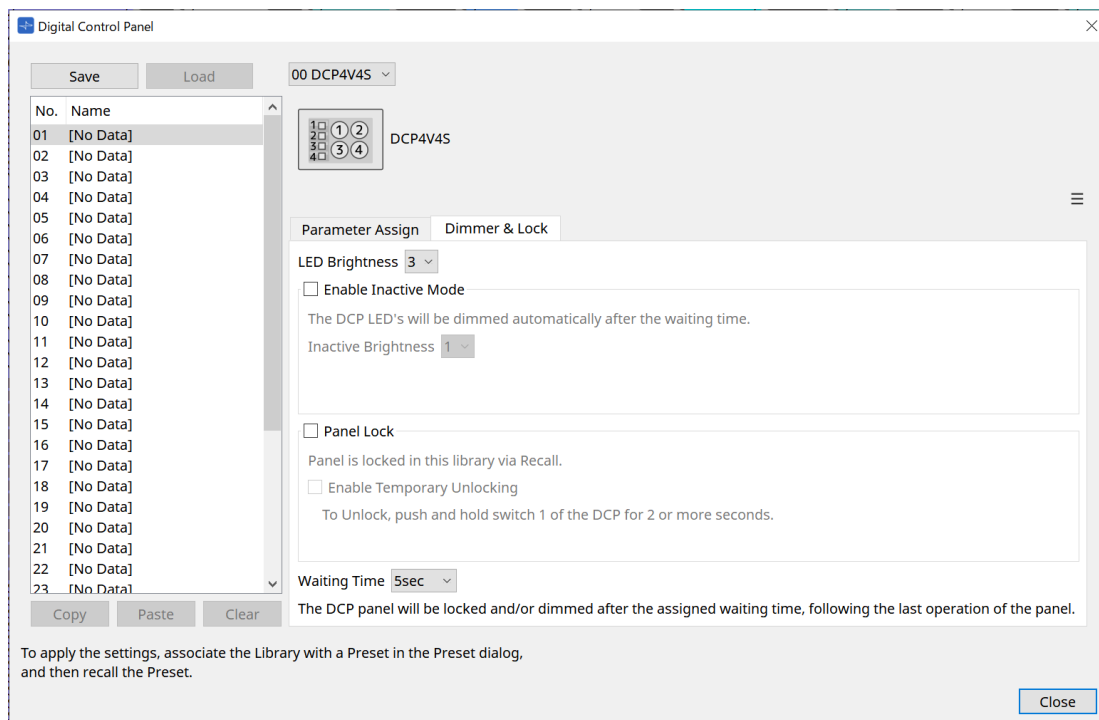

- **[LED Brightness] list box**  
Specifies the brightness of the DCP unit's LEDs. Higher values will make the LEDs brighter.
- **[Enable Inactive Mode] check box**  
If the check box is selected, the unit automatically enters inactive mode after a time duration specified in [Waiting Time].  
[Inactive LED Brightness] specifies the brightness of the LEDs when inactive.  
If the check box is cleared, the drop-down menu is grayed-out and you will be unable to set the brightness.
- **[Panel Lock] check box**  
If this check box is selected, the DCP panel will be locked when the preset library is recalled.  
If the [Enable Temporary Unlocking] check box is selected, pressing and holding down DCP switch 1 for two seconds will unlock the panel.
- **[Waiting Time]**  
Specifies the time from the last operation until the unit enters inactive mode or the panel is locked.

### Menu button

Click this button to execute the following functions.

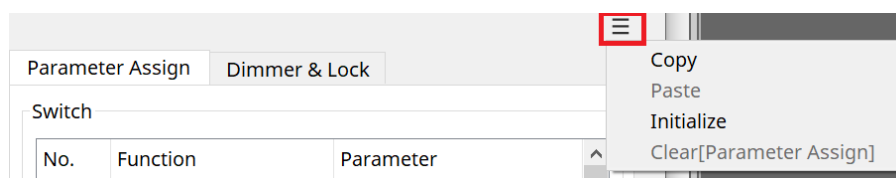

- **[Copy]**  
Copies the Parameter Assign, Dimmer & Lock, and Source Select of the displayed DCP to the copy buffer.
- **[Paste]**  
Overwrites the Parameter Assign, Dimmer & Lock, and Source Select settings of the same model from the copy buffer onto the displayed DCP.  
It is only possible to paste settings that were copied within the same MTX system.
- **[Initialize]**  
Initializes the Parameter Assign, Dimmer & Lock, and Source Select settings of the displayed DCP.

**• [Clear [Parameter Assign]]**

Initializes the Parameter Assign settings of the displayed DCP.

**[Close] button**

Closes the dialog box.

## 27.5. MRX7-D Setting Method

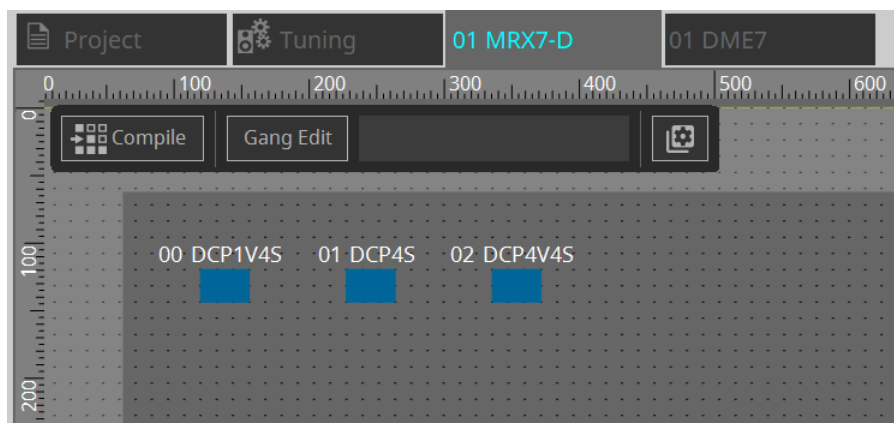

Double-click the DCP component and configure various settings.

For other operations, refer to the MTX5-D/MTX3 [DCP Component Settings](#).

### 27.5.1. DCP Component Settings

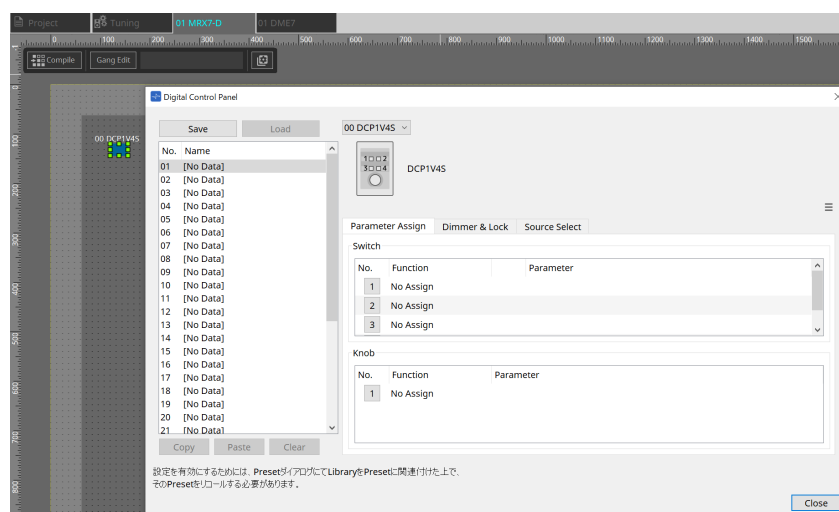

Double-click the DCP component to open the component editor.

#### [Library]

Up to 32 DCP-related settings can be saved as a [Library].

The Library stores the settings for all DCPs connected to the MRX7-D.



The Library can be used on the DCP itself by recalling it at the same time as the MRX7-D presets. Configure the settings in the dialog that appears when the [Recall Settings] button in the Presets area is pressed.



When the Library is recalled, all DCPs (up to 8 units) connected to the MRX7-D will be recalled at once.

When recalling a Library, any desired DCP can be excluded from the recall. Click on the [Recall Filter] button in the Presets area and set the filter in the dialog that appears.

For other operations, refer to the MTX5-D/MTX3 [DCP Component Settings](#).

## 27.5.2. [Parameter Assign] Tab

### 27.5.2.1 Settings Dialog (Switch)

Click the No. icon in the DCP component editor to display the Settings dialog.

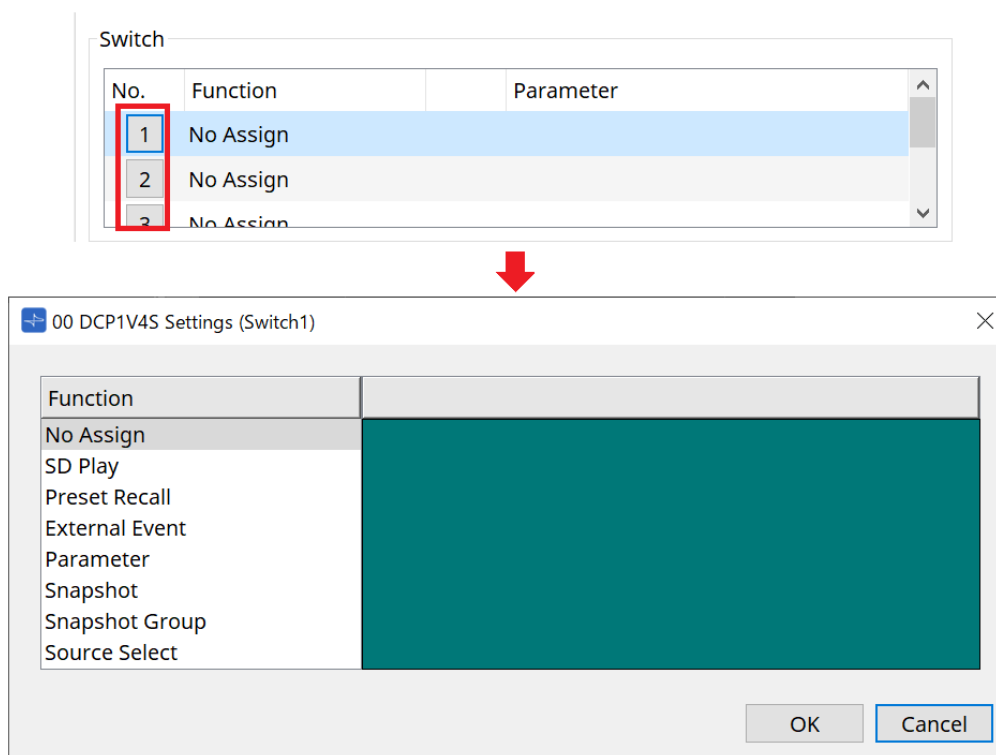

Refer to the DME7 [Settings Dialog \(Switch\)](#).

The differences compared to the DME7 are listed below.

#### [Snapshot Recall]

#### [Snapshot Group Recall]

#### [Preset Recall]

Registration Source	Registration Method
Parameter Sets Area	Drag & drop the snapshot into the green area of the Settings dialog. Drag & drop the snapshot group into the green area of the Settings dialog.
Presets Area	Drag & drop the preset into the green area of the Settings dialog.

#### [Parameter]

Registration Source	Registration Method
Component Editor	While holding the < Ctrl > key down, drag & drop the parameter into the green area of the Settings dialog.
Link Control Editor	While holding the < Ctrl > key down, drag & drop the Link Control into the green area of the Settings dialog.
Parameters Area	Drag & drop the parameter into the green area of the Settings dialog.



[Control Type] cannot be set.

## [MRX Source Select]

This function allows you to change the source of the Source Selector component using the switch, and to change the levels related to the source using the knob. Use a configuration that combines the Source Selector component and Fader component.

Assign Function: Source Selector to both the switch and the knob.

### Procedure

1. Add a Fader component and a Source Selector component to the device sheet and connect them.

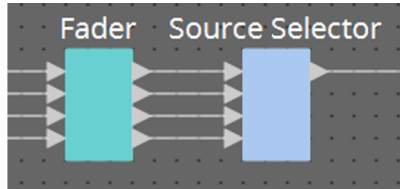

2. Select one of the Source Selector components being placed in the Source Select tab of the DCP component editor.

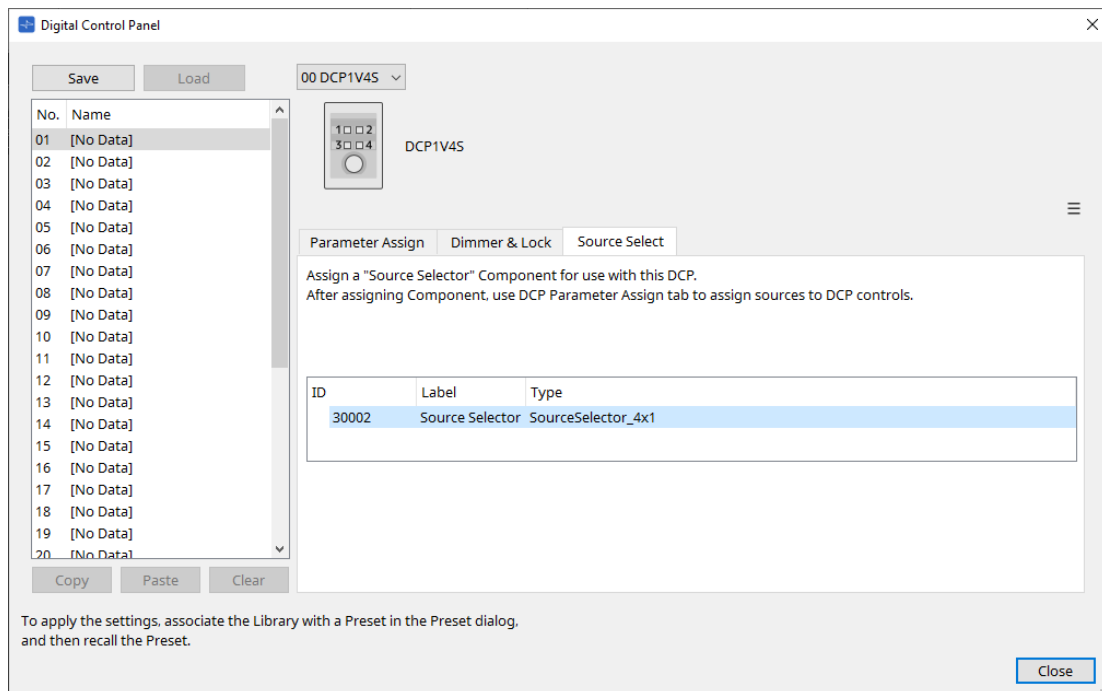

3. Assign the source for the Source Selector component to the switch.

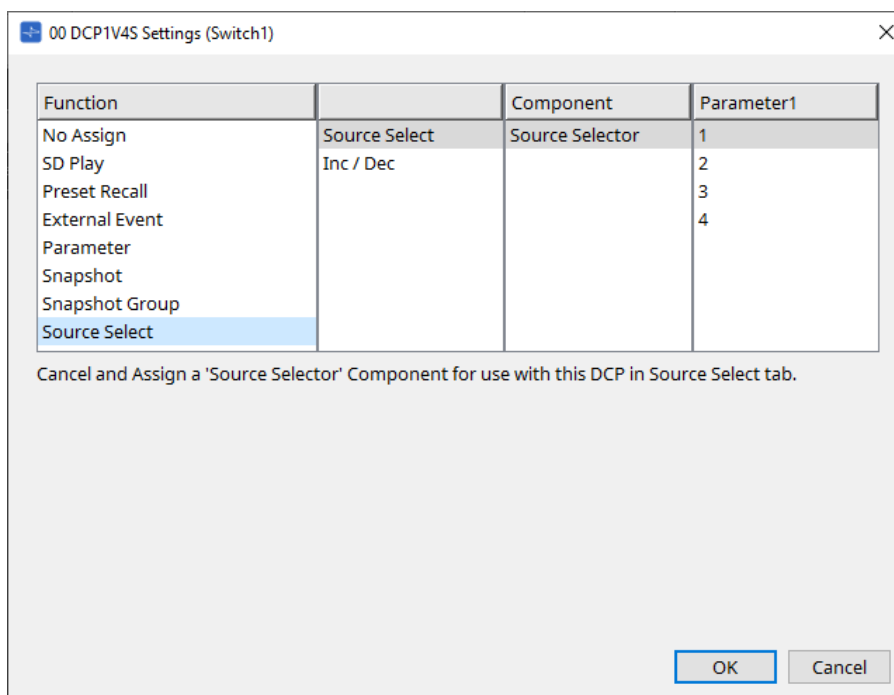

4. **Assigns the level for the fader component connected to the Source Selector component to the knob.** When a source is selected, assign the level parameter output from the Source Selector component by dragging & dropping it into the green area. Set for each source.

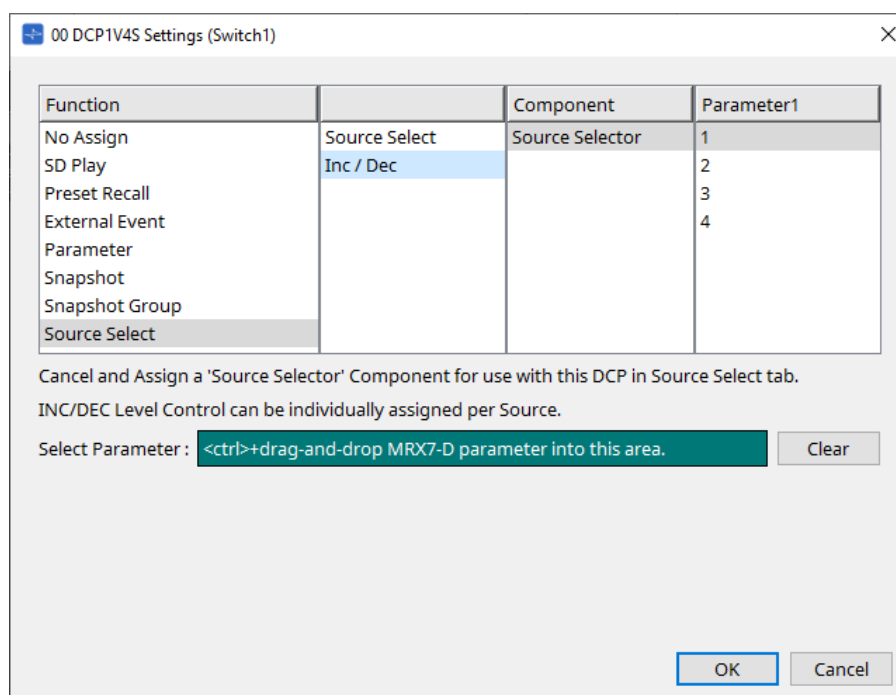

For example, if you select source 1 with switch 1, 1Ch of the Fader component will be assigned to knob 1, and if you select source 2 with switch 2, 2Ch of the Fader component will be assigned to the same knob 1.



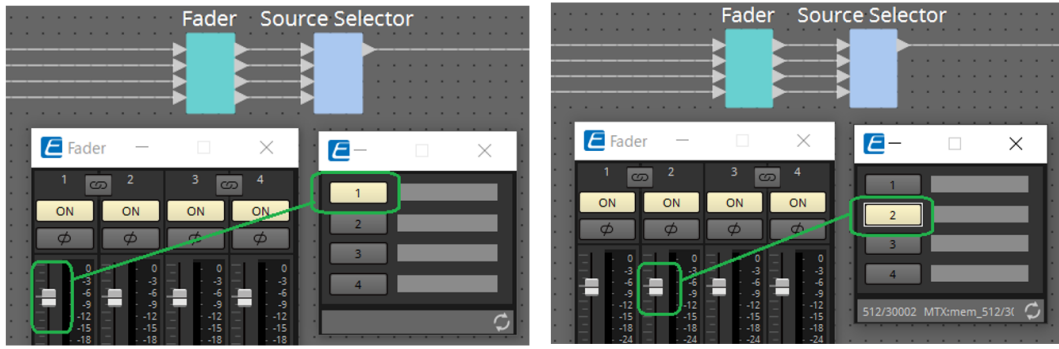

### 27.5.2.2 Settings Dialog (Knob)

Click the No. icon in the DCP component editor to display the Settings dialog.  
Refer to the DME7 [Settings Dialog \(Knob\)](#).

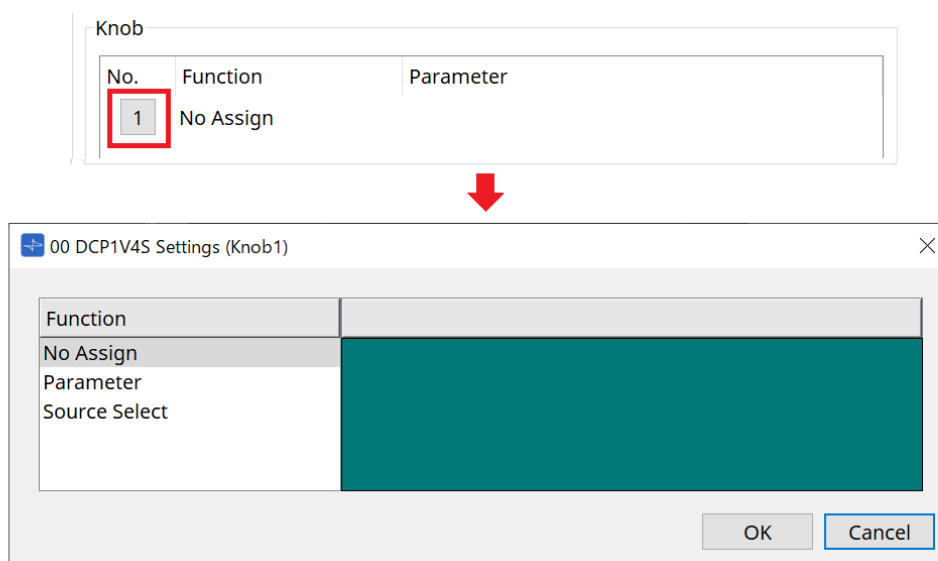

The differences compared to the DME7 are listed below.

#### [Parameter]

Registration Source	Registration Method
Component Editor	While holding the < Ctrl > key down, drag & drop the parameter into the green area of the Settings dialog.
Link Control Editor	While holding the < Ctrl > key down, drag & drop the Link Control into the green area of the Settings dialog.
Parameters Area	Drag & drop the parameter into the green area of the Settings dialog.

#### [MRX Source Select]

Refer to MRX Source Select in "Settings Dialog (Switch)."

### 27.5.3. [Dimmer & Lock] Tab

Refer to the MTX5-D/MTX3 [Dimmer & Lock Tab](#).

### 27.5.4. [Source Select] Tab

Select one of the Source Selector components placed on the device sheet.  
For a description of the functions, refer to "Settings Dialog (Switch)."

## 28. Wall-mount Controller: MCP1

### 28.1. Overview

The MCP1 is a wall-mounted control panel for controlling device parameters, presets, etc.

The External Event function allows products that are not supported by ProVisonaire Design to be controlled.

A home page and six pages can be set, and up to 36 parameters can be assigned to the switches.

Please also refer to the MCP1 Installation Manual for information on handling the MCP1.

### 28.2. Project Sheet

This is the sheet on which devices are placed. When placing devices, the Settings screen shown below is displayed.

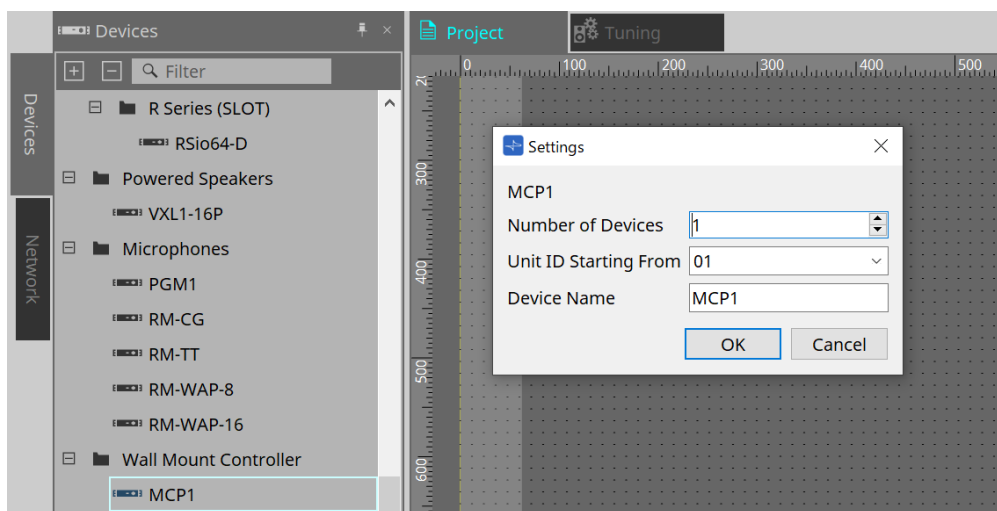

- **Number of Devices**  
Selects the number of MCP1 units to be placed on the sheet.
- **Unit ID Starting From**  
The starting number for the device Unit IDs can be selected.
- **Device Name**  
The device name can be displayed and edited.

## 28.2.1. Properties Area

Displays/edits the MCP1 information.

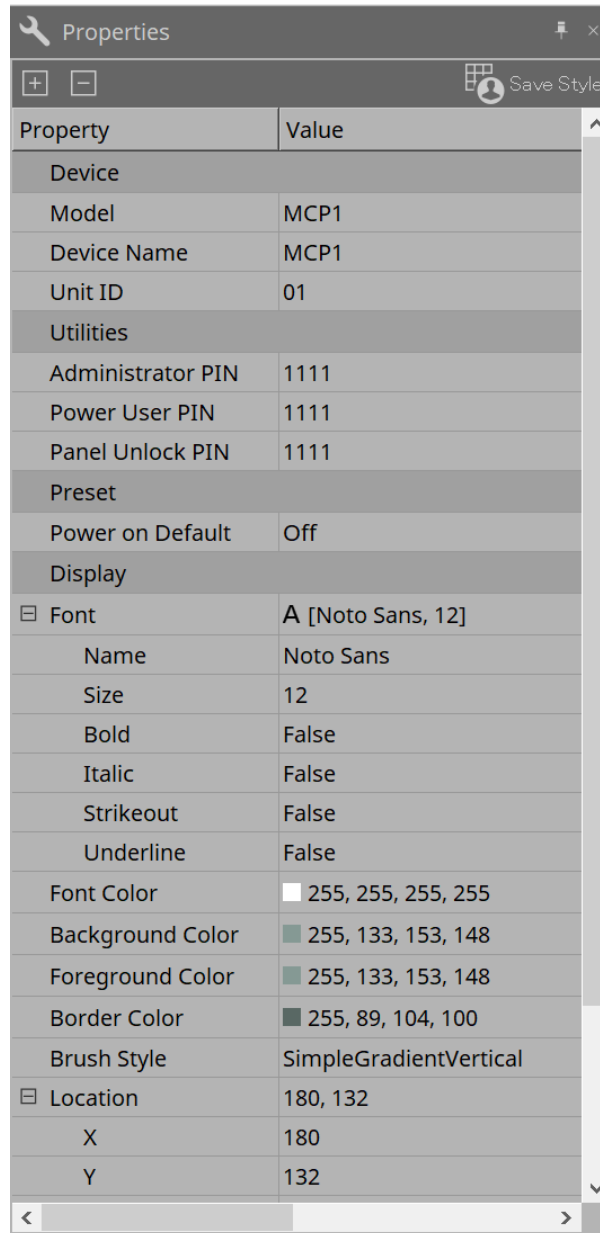

Property	Value
<b>Device</b>	
Model	MCP1
Device Name	MCP1
Unit ID	01
<b>Utilities</b>	
Administrator PIN	1111
Power User PIN	1111
Panel Unlock PIN	1111
<b>Preset</b>	
Power on Default	Off
<b>Display</b>	
Font	A [Noto Sans, 12]
Name	Noto Sans
Size	12
Bold	False
Italic	False
Strikeout	False
Underline	False
Font Color	255, 255, 255, 255
Background Color	255, 133, 153, 148
Foreground Color	255, 133, 153, 148
Border Color	255, 89, 104, 100
Brush Style	SimpleGradientVertical
Location	180, 132
X	180
Y	132

### • Utilities

#### ◦ Administrator PIN

This is the code to open the Settings Page on the main unit. It is a four-digit number. It can also be used as the Power User PIN and Panel Unlock PIN.

#### ◦ Power User PIN

This is the code to open the page when "Power User Page (PIN required)" is enabled. It is a four-digit number.

#### ◦ Panel Unlock PIN

This is the code to unlock the panel lock. It is a four-digit number.

## 28.3. Setting Method

1. **Double-click the MCP1 placed on the Project sheet.**  
[Component Editor](#) will be displayed.

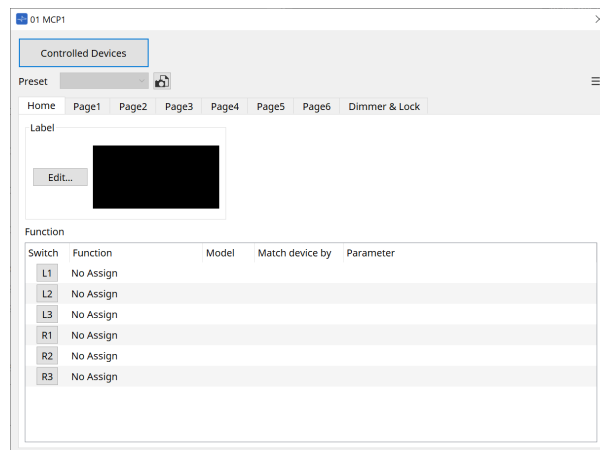

2. **Click on the [Controlled Devices] button in the Component Editor.**  
 The [Controlled Devices dialog](#) will be displayed.  
 On this screen, register the devices to be controlled by the MCP1.

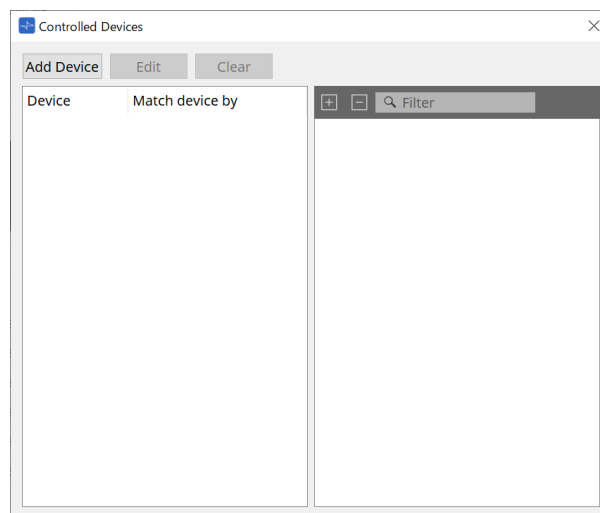

For devices with fixed configurations, such as the MTX5-D and PC-D series, the device does not necessarily need to be placed on the Project sheet. However, devices such as the DME7 and MRX7-D, whose configurations can be freely changed by the user, must be placed on the Project sheet. This is to assign parameters by dragging and dropping them from the Component Editor of the device sheet, the Parameter Sets area, etc.

### 3. Click on the [Switch Selection Button] in the Component Editor.

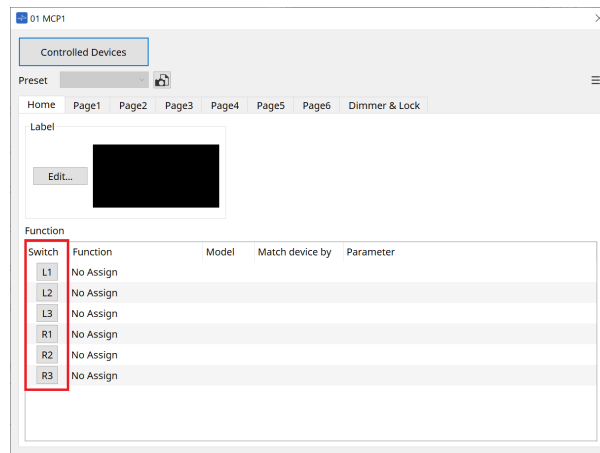

The [Settings dialog](#) will be displayed.

### 4. Drag and drop parameters from the parameter list in the Controlled Devices dialog to the Settings dialog to assign them to switches.

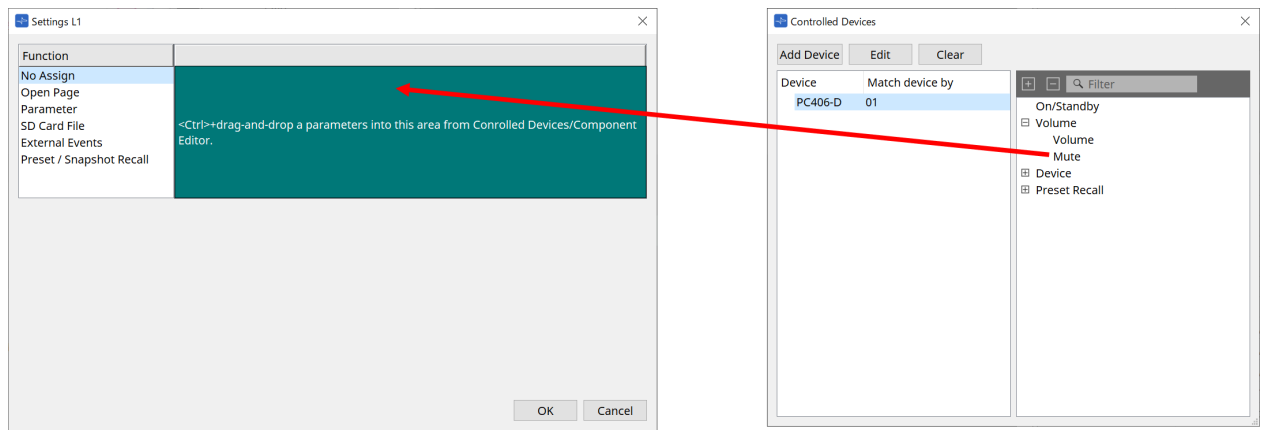

For the DME7 and MRX7-D, drag parameters from the Component Editor or the Parameters area. Even if you move to the DME7 or MRX7-D device sheet, the Settings dialog will remain displayed.

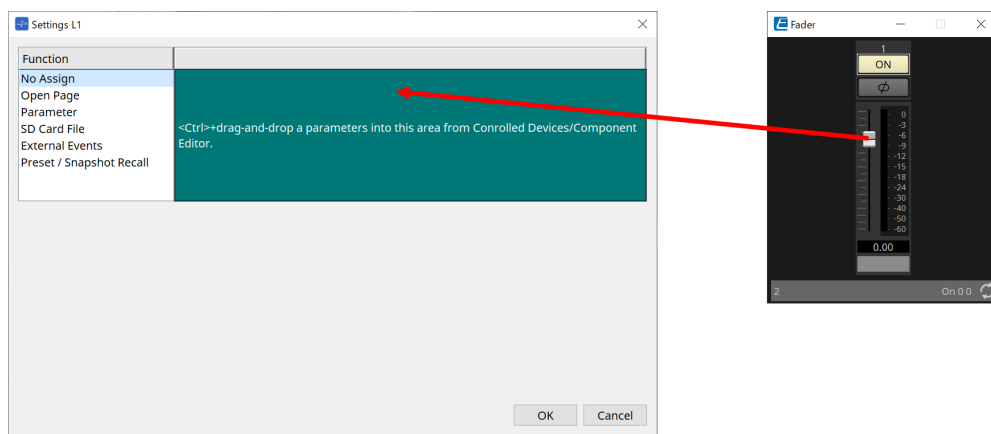

Refer to the [Settings dialog](#) for information on how to assign parameters.



To control a product that is not supported by ProVisionaire Design, use Function > External Event.

5. **Click on the [Preset] button.**

The [Preset List dialog](#) will be displayed. Presets save all page and Dimmer & Lock settings. Loading a preset will load the page and Dimmer & Lock settings into the MCP1 Editor. If you recall a preset while online, the panel settings on the MCP1 main unit will also change.

## 28.4. Component Editor

Double-clicking a device on the Project sheet will open the editor.

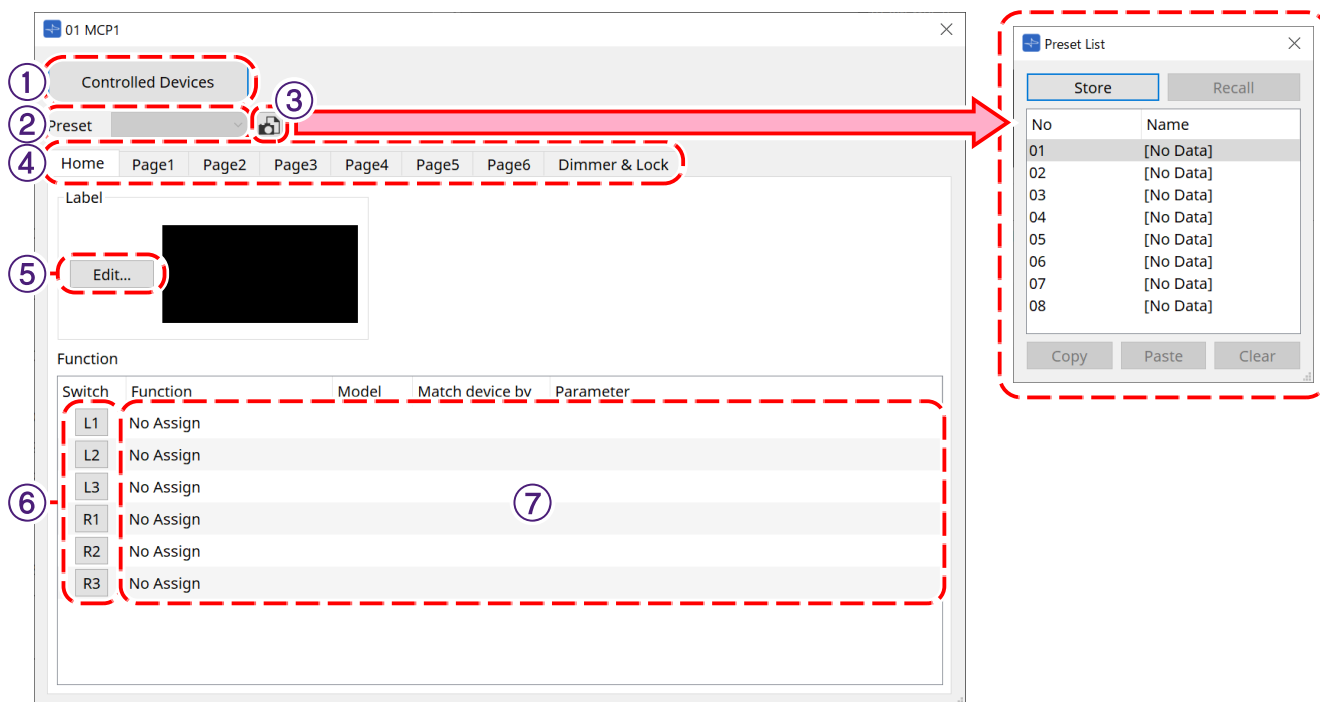

### ① [Controlled Devices] Button

Opens the [Controlled Devices dialog](#).

### ② Preset list

Recalls presets.

### ③ [Preset] Button

Opens the [Preset List dialog](#).

### ④ [Home]/[Page 1] to [Page 6] tabs

Set the MCP1 pages.

The [Home] page is the page that is displayed when the MCP1 is started up or the Home switch is pressed. On the [Home] page, you can switch pages by assigning [Open Page] to a switch.

The [Page 1] tab will be explained here.

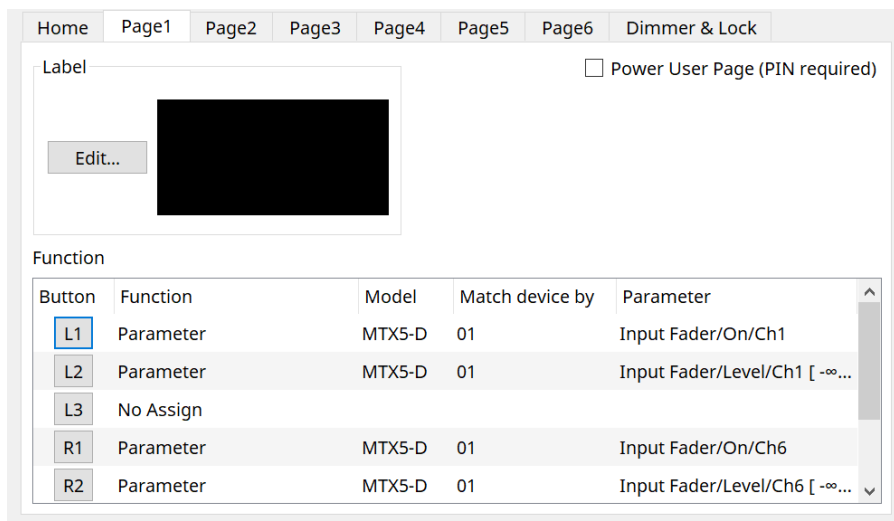



- **[Power User Page [PIN required]] checkbox (other than [Home] page)**

If checked, you will be required to enter the Power User PIN when opening a page on the MCP1 main unit. The Power User PIN is set in the device's Properties area > Utilities.

- ⑤ **Label [Edit] Button**

Opens the [Label dialog](#).

- ⑥ **Function [Switch] selection button**

Click to open the [Settings dialog](#).

- ⑦ **[Function]/[Model]/[Match device by]/[Parameter]**

Displays an overview of the settings made on the Settings screen.

### 28.4.1. [Dimmer & Lock] Tab

Sets the brightness of the MCP1's display and switches, and the operation of the panel lock.

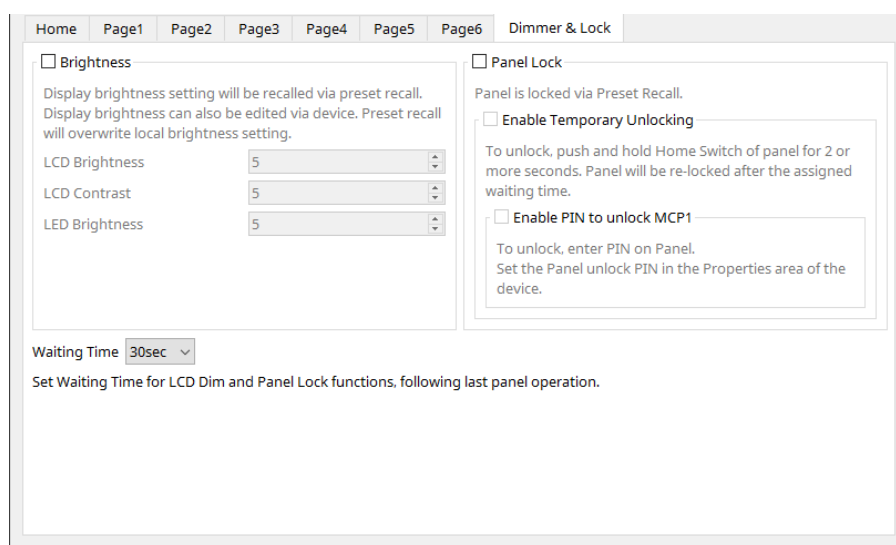

- **[Brightness] checkbox**

If this box is checked, the brightness and contrast of the display and the brightness of the switches can be changed when a preset is recalled.

[LCD Brightness] is the brightness of the display. The higher the number, the brighter the display will be.

[LCD Contrast] is the contrast of the display. The higher the number, the greater the difference between brightness and darkness.

[LED Brightness] is the brightness of the switches. The higher the number, the brighter the switches will be.

- **[Panel Lock] checkbox**

If this box is checked, the MCP1 panel will be locked when a preset is recalled. If the [Enable Temporary Unlocking] box is checked, the panel can be unlocked by pressing and holding the Home switch on the MCP1 for longer than 2 seconds.

If the [Enter PIN to unlock MCP1] box is checked, you will be prompted to enter the Panel Unlock PIN when unlocking the panel.

- **[Waiting Time]**

Sets the time from the last operation until the MCP1 enters hibernation or a locked state.

## 28.4.2. Controlled Devices Dialog

Displayed when the [Controlled Devices] button in the [Component Editor](#) is clicked. Register the devices to be controlled by the MCP1.

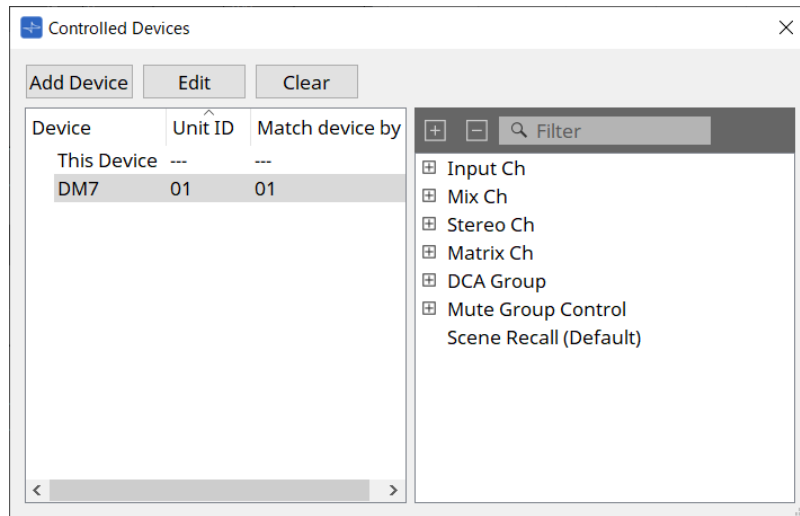

### • [Add Device] Button

Click to open the Add Device dialog.  
Register the devices to be controlled by the MCP1.

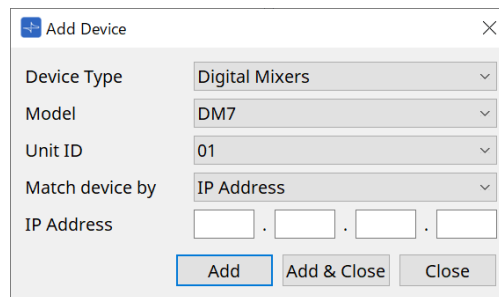

Selects how the MCP1 searches for devices on the network in [Match Device by].  
Select [IP Address] to search by device IP address, or select [Unit ID] to search by device Unit ID.



Unit ID can be used as a device identifier when adding devices to a sheet.

### • [Edit] Button

Click to open the Unit ID & Match Device by dialog.



Changes the [Unit ID] and [Match Device by] of the device selected in the Device List.

### • [Clear] Button

Deletes the device selected in the Device List.

### • Device List

Displays the registered devices.

• **Parameter List**

Displays the parameters of the device selected in the Device List.  
Parameters can be registered in the Settings dialog by dragging and dropping them.



Register parameters for models whose configurations can be freely changed, such as the DME7 and MRX7-D, by dragging and dropping them from the Component Editor or the Parameters area to the Settings dialog.

### 28.4.3. Preset List Dialog

Up to eight MCP1-related settings can be saved as presets.

Presets can be recalled from external devices. They can also be recalled with other MCP1 switches.

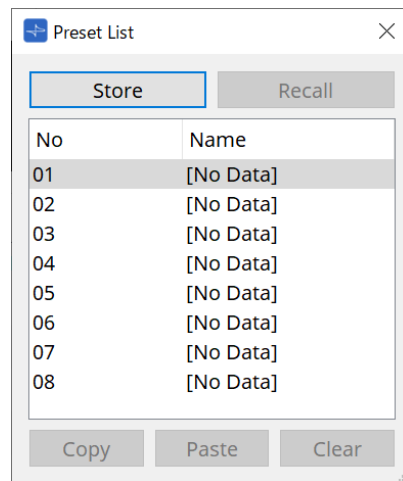

- **[Store] Button**  
Saves the [Home]/[Page 1] to [Page 6]/[Dimmer & Lock] settings to a preset.
- **[Recall] Button**  
Recalls the selected preset.  
The settings are expanded to [Home]/[Page 1] to [Page 6]/[Dimmer & Lock].  
If you recall a preset while online, the panel settings on the main unit will also change.
- **[Copy] Button**  
Copies the selected preset.
- **[Paste] Button**  
Pastes the copied preset to the selected preset.
- **[Clear] Button**  
Clears the selected preset.

## 28.4.4. Label Dialog

Creates an image for each page to be displayed on the MCP1 main unit's display.

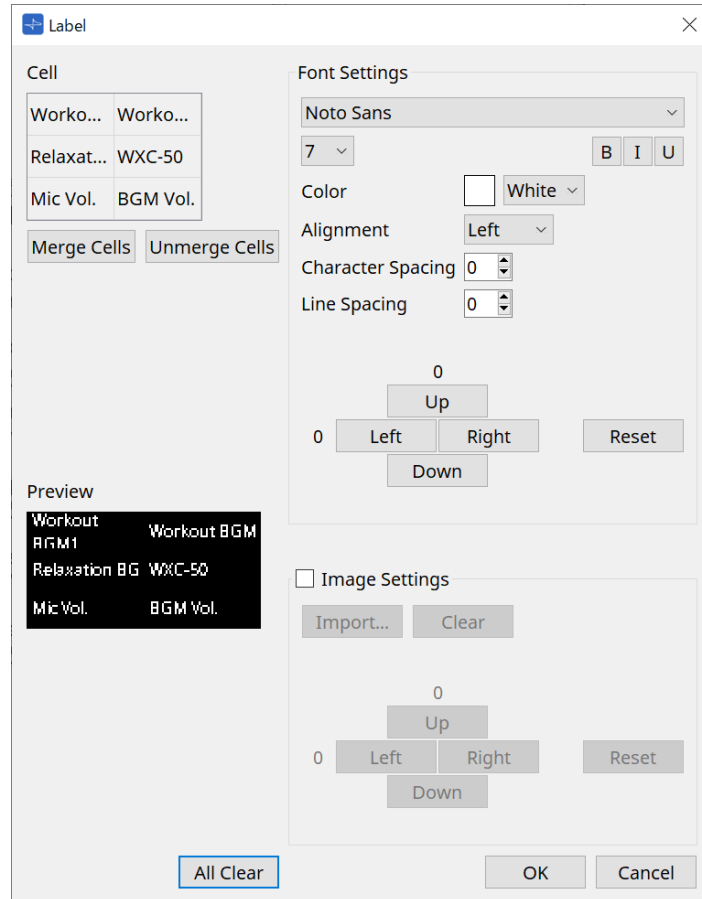

- **[Cell]**

Edits the page screen.

To edit text, double-click the cell or select the cell and press the < F2 > key.

Press the < Enter > key or use the mouse to select another cell to confirm.

If including a background image in a cell, select the cell and check the [Image Settings] checkbox. Press the [Import] button and select the image file.

Cells can be moved not only with the mouse, but also with the cursor keys, < Tab > key, and < Enter > key. A range of cells can also be selected by moving through them while holding down the < Shift > key.

- **[Merge Cells] Button**

Select multiple cells and click this to merge them.

- **[Unmerge Cells] Button**

Select merged cells and click this to unmerge them.

- **[Preview]**

Displays the page image.

The text and images set in [Cell] can be checked.

- **Font Settings Area**

Sets the font of the text displayed in the selected cell.

- **Font List Box**

Selects a font. Fonts installed on the computer can be selected.

- **Font Size List Box**

Selects the font size.

- **[B]/[I]/[U] Buttons**  
Click to make the text in the cell bold/italicized/underlined.
  - **Color**  
Displays the color of the text in the cell. Click on the button to switch between white and black.
  - **[Alignment] List Box**  
Selects the alignment of the text in the cell.
  - **[Character Spacing] spin box**  
Sets the spacing between characters in a cell.
  - **[Line Spacing] spin box**  
Sets the spacing between rows in a cell.
  - **[Up]/[Left]/[Right]/[Down]/[Reset] Buttons**  
Adjust the text position in the cell. The amount of movement is displayed as a numerical value. Click on the [Reset] button to restore it to the initial value.
- **Image Settings**  
The background image of the selected cell can be set when this is checked.
    - **[Import] Button**  
Click to open the Open File dialog.  
The selectable image extensions are **.png**, **.bmp**, and **\*.jpg**.  
After selecting the image data, click on the [OK] button to open the Re-size Image dialog where you can select how to arrange the image in the cell.
- 
- **[Clear] Button**  
Click to delete the background image.
  - **[Up]/[Left]/[Right]/[Down]/[Reset] Buttons**  
Adjust the background image position in the cell. The amount of movement is displayed as a numerical value. Click on the [Reset] button to restore it to the initial value.
- **[All Clear] Button**  
Initializes all cell information.
  - **[OK] Button**  
Retains the setting information and closes the dialog.
  - **[Cancel] Button**  
Discards the setting information and closes the dialog.

## 28.4.5. Settings dialog

Registers parameters and presets to be controlled by the MCP1.

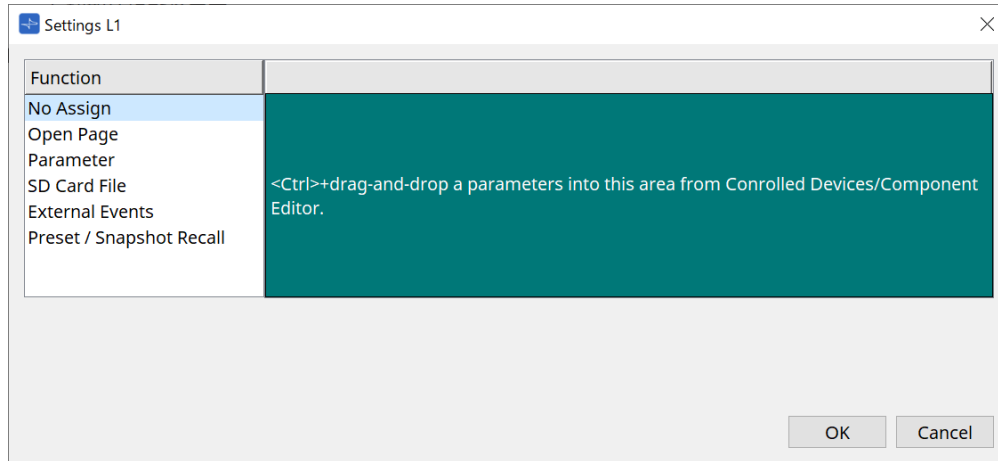

Parameters and presets can be registered to switches by dragging and dropping them into the green area.

Registration Source	Registration Method
Parameter List in the Controlled Device dialog	Drag and drop the parameter or preset into the green area of the Settings dialog.
DME7 and MRX7-D Component Editor*1	While holding down the < Ctrl > key, drag and drop the parameter into the green area of the Settings dialog.
DME7 and MRX7-D Parameters Area	Drag and drop the parameter into the green area of the Settings dialog.
MRX7-D Link Control Editor	While holding down the < Ctrl > key, drag and drop the Link Control into the green area of the Settings dialog.
DME7 Parameter Sets Area	Drag and drop the snapshot into the green area of the Settings dialog.
MRX7-D Parameter Sets Area	Drag and drop the snapshot into the green area of the Settings dialog. Drag and drop the snapshot group into the green area of the Settings dialog.
MRX7-D Presets Area	Drag and drop the preset into the green area of the Settings dialog.

\*1 For devices other than the DME7 and MRX7-D, parameters can only be registered from the Parameter List in the Controlled Device dialog.

## Function

- **[No Assign]**  
Function is not assigned.

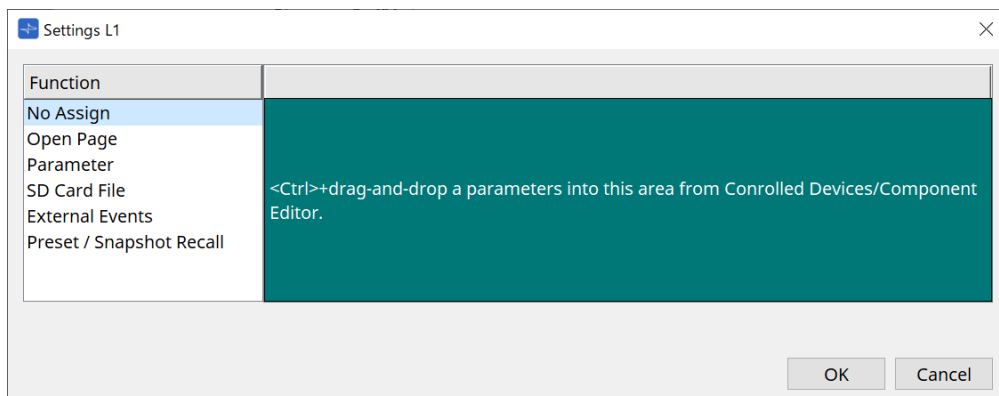

- **[Open Page (Home page only)]**

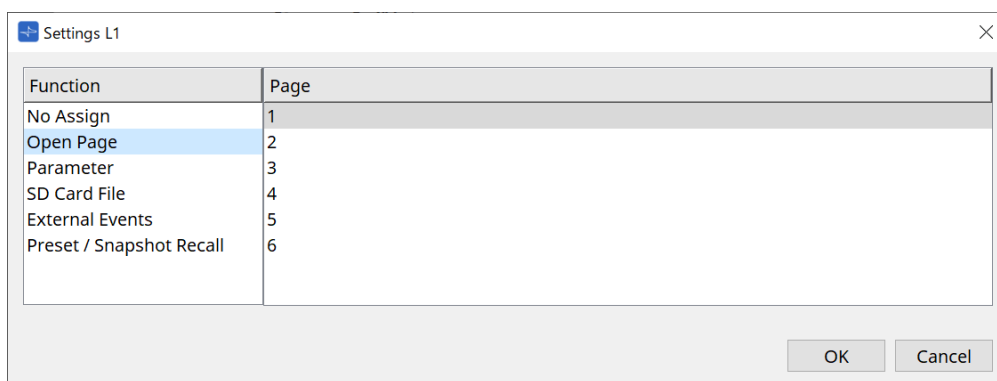

Press the switch to change the MCP1 page.

- **[parameter]**

- **Control Type list box**

When Parameter Value Edit is selected

Operates the assigned parameter within the range specified by the Lower Limit and Upper Limit. Select the parameter you want to operate on the MCP1 main unit by touching it, and operate it using the L1/2/3 and R1/2/3 switches and return switch.

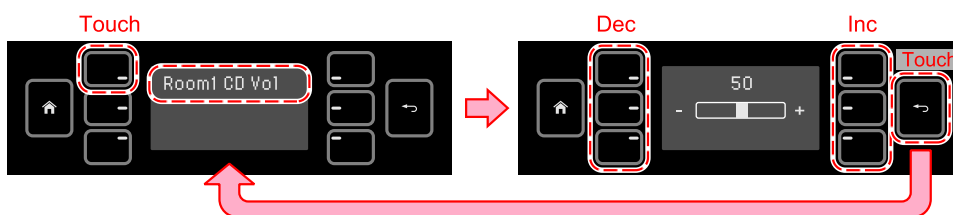



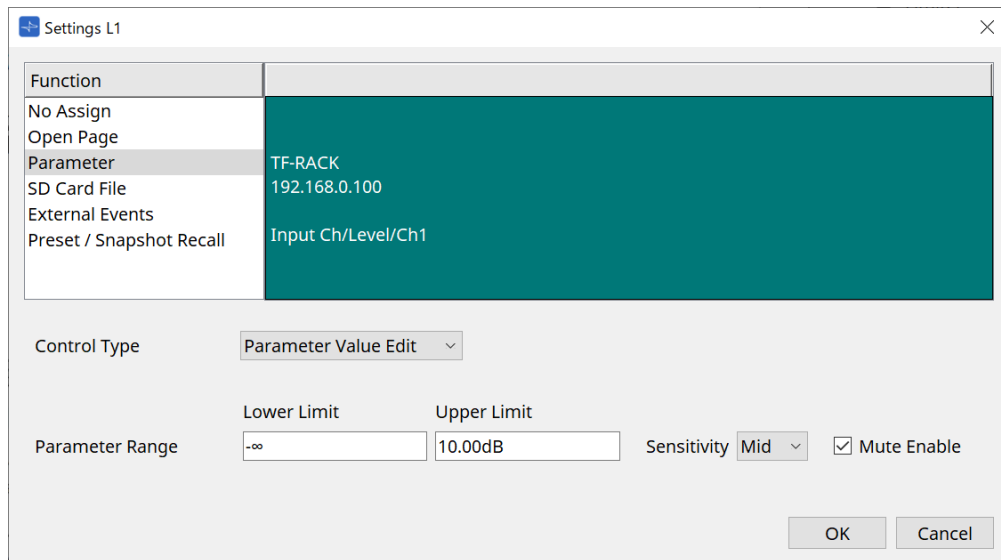

◦ **Parameter Range**

Sets the parameter’s range of motion.  
Click Lower Limit/Upper Limit to display the controls.

◦ **Mute Enable checkbox**

When this is turned on, a Mute state ( $-\infty$  dB) occurs when the level falls below the value set in [Lower Limit].

◦ **[Sensitivity]**

Sets the sensitivity with which the parameter changes in response to switch operations.

When Direct Parameter Value is selected

Sets the assigned parameter to the value specified by Value.  
Click Parameter Value to display the controls.

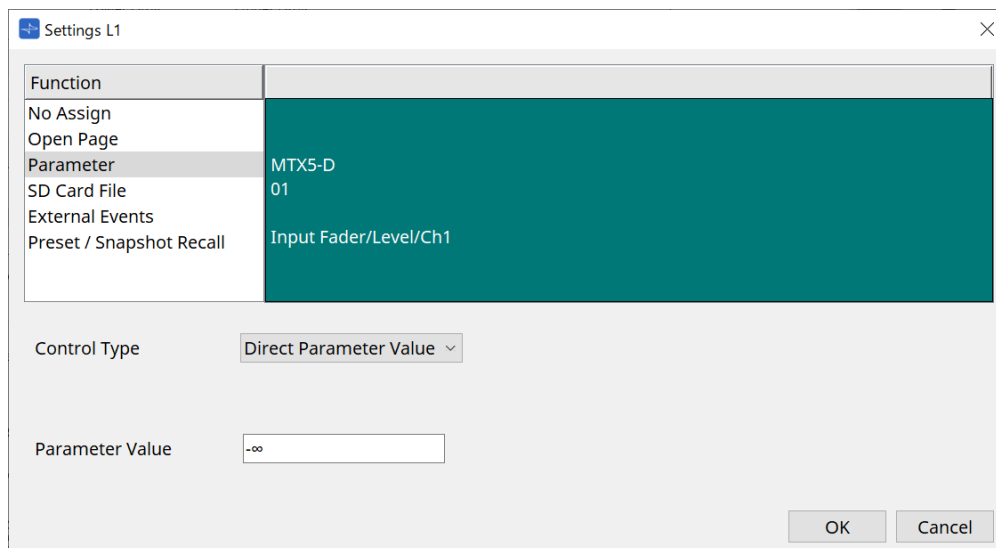
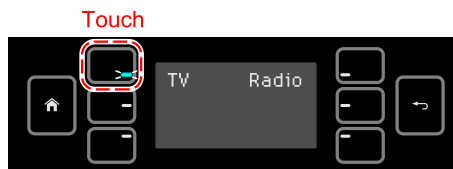

## • [SD Card File Manager]

### For DME7/MRX7-D or MTX3/MTX5-D placed on the Project sheet

When SD Card File > Sel & Play is assigned from Controlled Devices, the SD Card File Manager dialog starts.

For the DME7, one file or multiple consecutive files can be selected.

For the MTX3, MTX5-D, and MRX7-D, only one file can be selected.

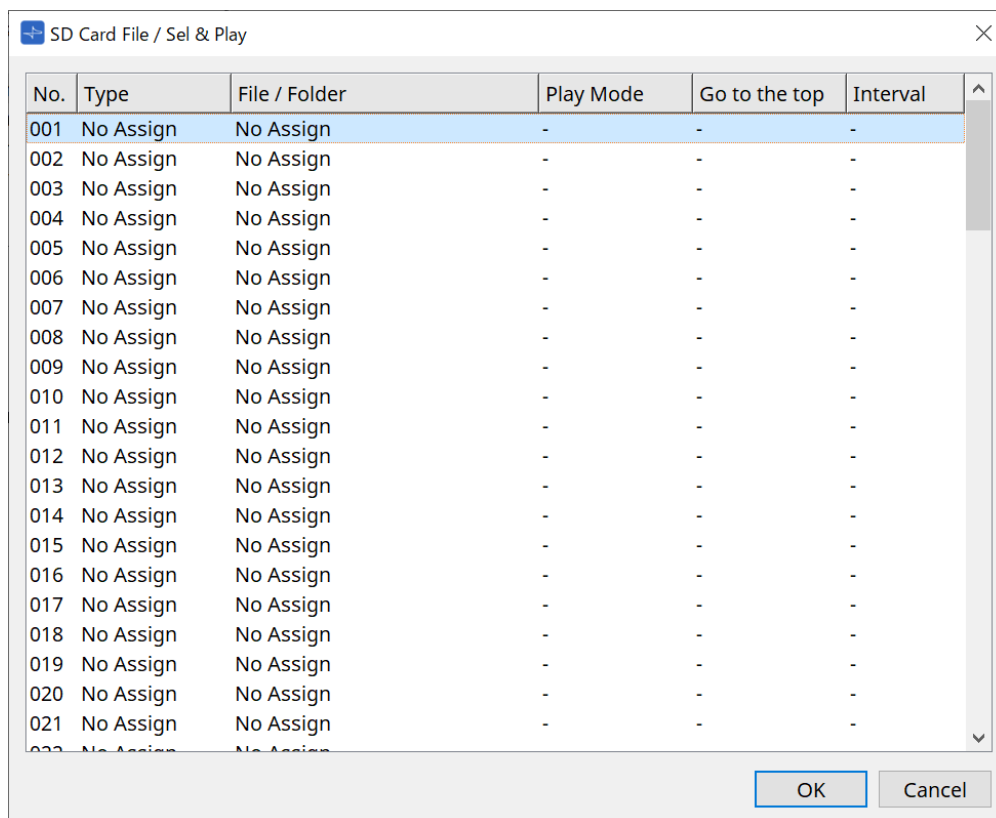

For the DME7, multiple files can be selected.

### When multiple files are selected (for DME7 only)

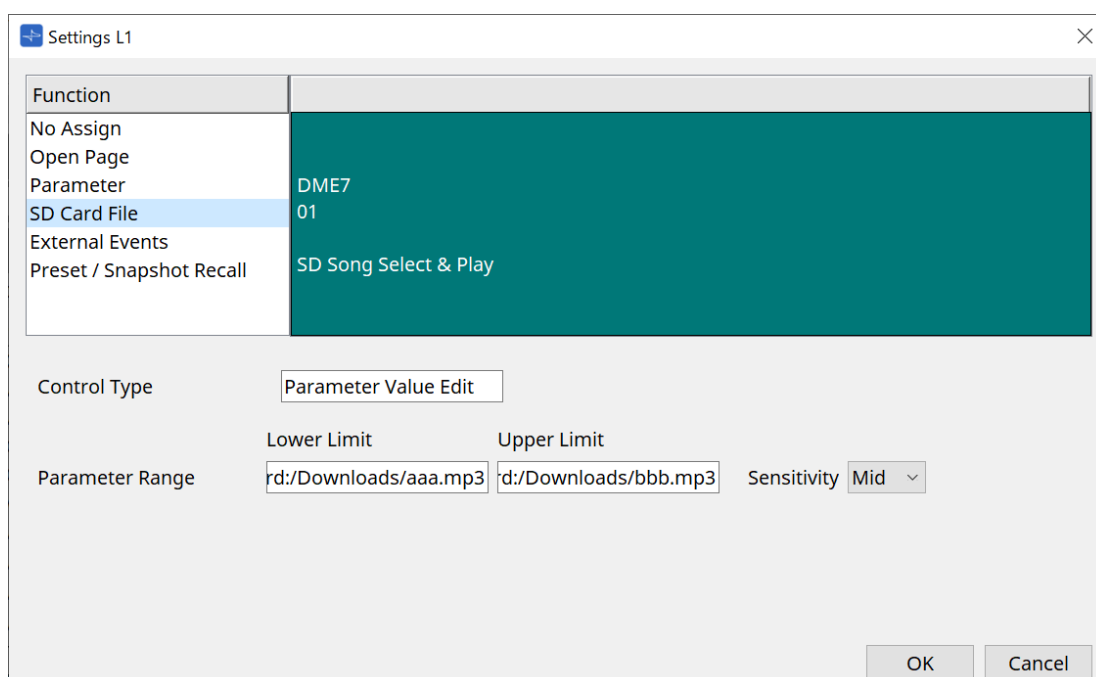

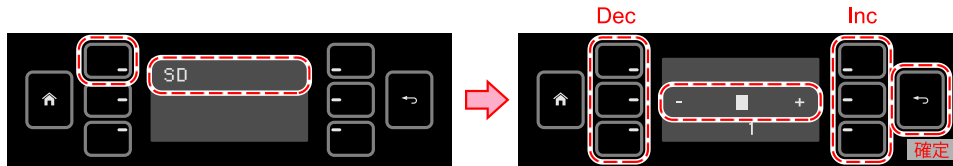

When one file is selected

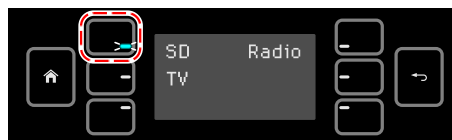
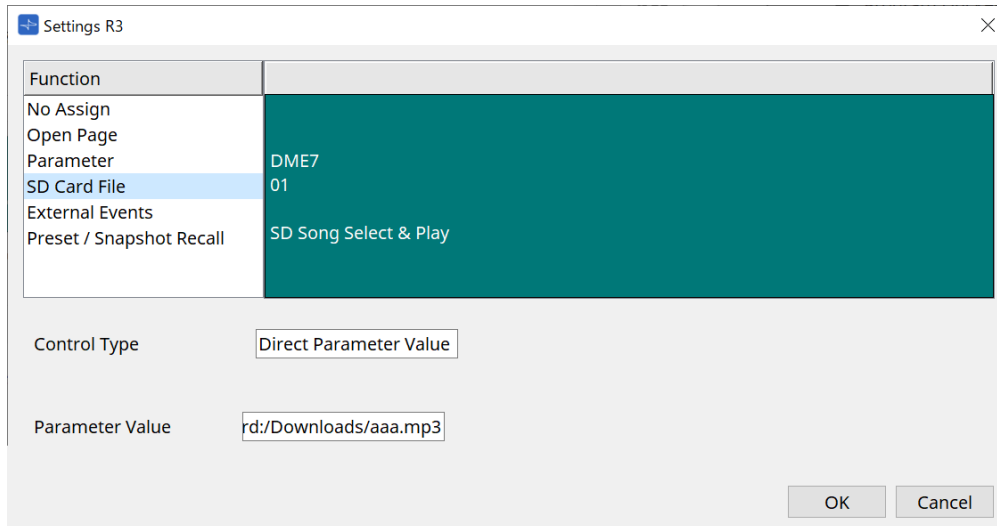

押している間だけ LED 点灯

**For MTX3/MTX5-D not placed on the Project sheet**

After assigning SD Card File > Sel & Play from Controlled Devices by dragging and dropping it, configure the settings related to file playback.

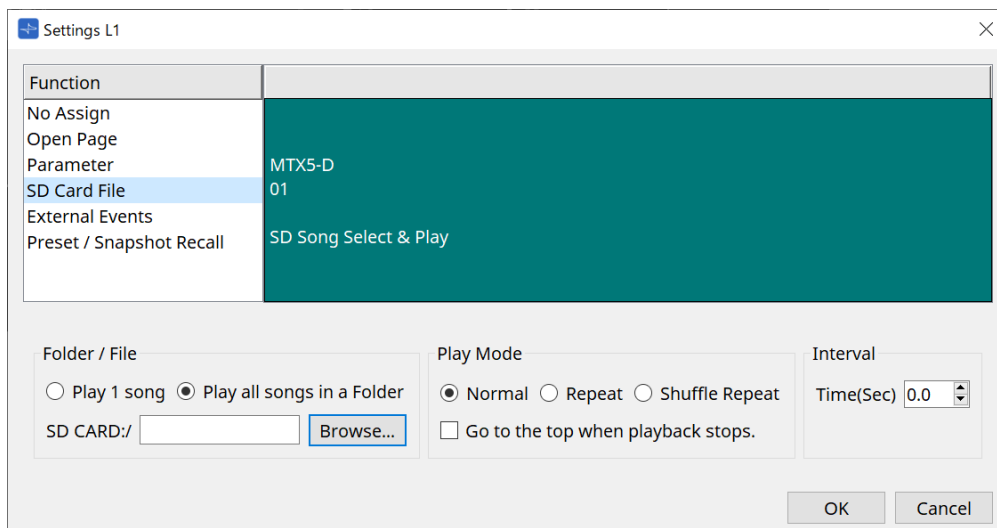

Refer to the DME7 [SD Card File Manager dialog](#) for setting details.

- **[External Event]**

The screenshot shows the 'Settings L2' window with the 'External Events' menu item selected. The 'Event Mode' is set to 'On/Off'. Below this is a table for 'Controlled Devices' with columns for No., Protocol, IP Address, Port No., Delay, and Comments. The table contains four rows, all with 'None' in the Protocol column and '0' in the Port No. and Delay columns. Below the table is a 'Command' section with 'On' and 'Off' buttons, 'Hex' and 'ASCII' radio buttons, and 'Overwrite' and 'Convert' checkboxes. There are also 'Clear' buttons for both the Hex and ASCII input fields. At the bottom right are 'OK' and 'Cancel' buttons.

No.	Protocol	IP Address	Port No.	Delay	Comments
1	None	.	0	0.0s	
2	None	.	0	0.0s	
3	None	.	0	0.0s	
4	None	.	0	0.0s	

- **[Event Mode] List Box**

When an event is assigned to a switch, it operates as follows.

[On/Off]: The MCP1 alternately sends an On command and Off command each time the switch is pressed.

[1shot]: The MCP1 sends the set command each time the switch is pressed.

- **Controlled Device**

Sets the information for the device receiving commands.

For details on how to configure the receiving device, refer to the documentation for each device's commands.

- **Protocol**

Selects the protocol supported by the device receiving commands.

- **IP Address**

Set the IP address of the device receiving commands.

- **Port No.**

Sets the port number of the device receiving commands.

- **Delay**

Sets the delay for each command, with the time the switch was pressed as 0.

- **Comments**

Allows for input of text.

- **Command On/Off**

Displayed when set to On/Off in the [Event Mode] list box.

Sets the respective commands when the switch is on and off.

Commands are entered in two-digit hexadecimal format.

- **Overwrite/Insert**

When set to [Insert], input in the Command text box becomes an insert, and hexadecimal numbers can be added at the beginning or in the middle.

- **Hex**

Sets the command to control the device in hexadecimal.

- **Clear**

Deletes the command.

- **Ascii**

If commands to control the device are provided as character strings in the specifications, etc., enter the commands and use the [Converter] button to convert them into hexadecimal.

- **[Convert] Button**

Converts commands in character strings into hexadecimal and enters them in "Hex".

- **[Presets/Snapshots]**

- **Control Type**

When Parameter Value Edit is selected

Sequentially numbered presets or snapshots can be assigned to a single device.

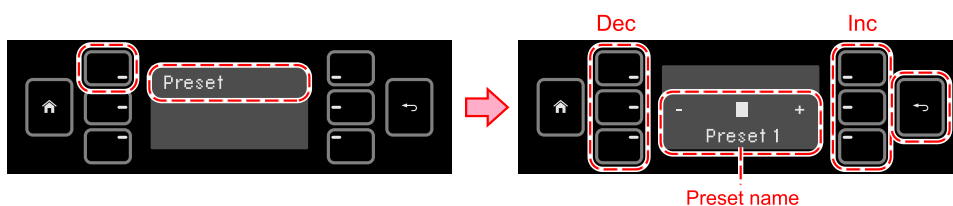
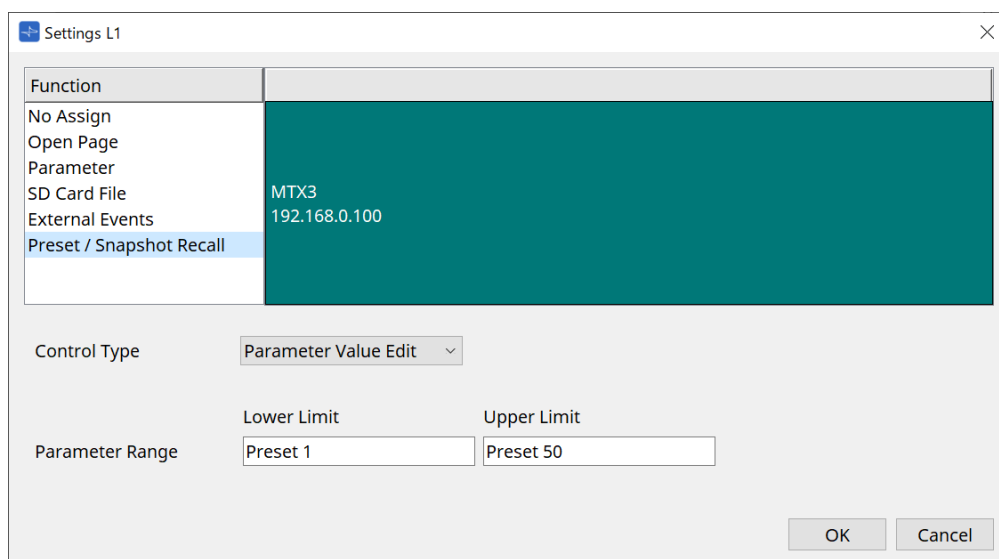

When Direct Parameter Value is selected

Multiple presets, snapshots, or snapshot groups can be assigned to the same switch at the same time by repeating the assign operation. Presets for different devices can also be assigned at the same time.



For the Rivage PM series and DM7 series, only the Direct Parameter Value can be selected.



For the MRX7-D snapshot group, only the Direct Parameter Value can be selected.

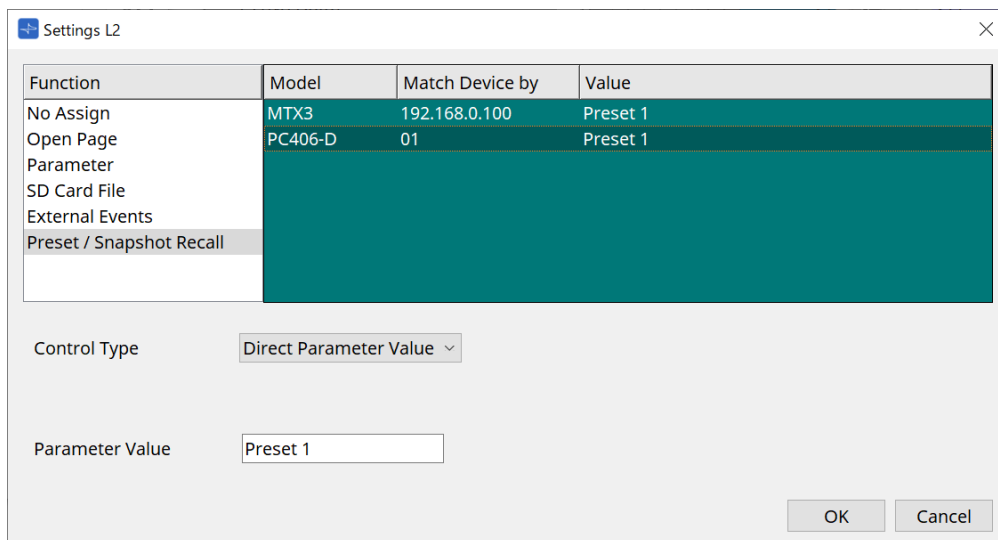

押している間だけ LED 点灯

## 28.5. Alert List

Refer to the MTX5-D/MTX3 [Alert List](#).

## 29. YDIF

### 29.1. YDIF

YDIF is a digital audio transmission format that can send and receive up to 16 channels of audio and wordclock using an Ethernet cable. By connecting devices (MTX series/XMV/EXi8/EXo8) via Ethernet cable, a maximum of 16 channels of audio signals can be transferred without degradation.

By using YDIF, it is possible to easily switch signal routing without changing cable connections.

For example, as shown in the diagram below, a situation such as "outputting the same microphone input signal from multiple speakers" can be handled just by setting the YDIF routing.

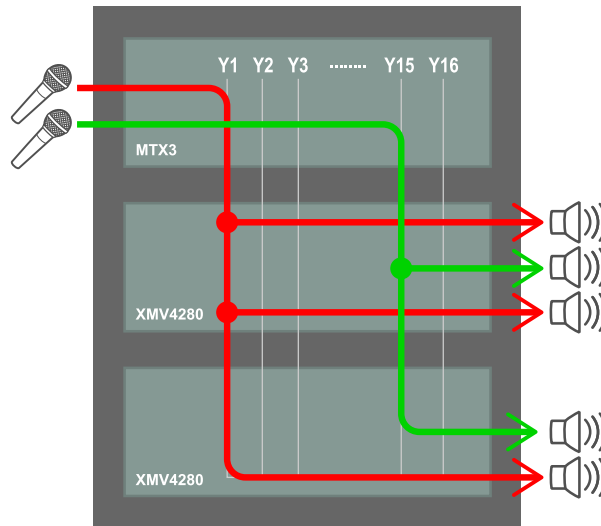

### 29.2. YDIF setting method (Project sheet)

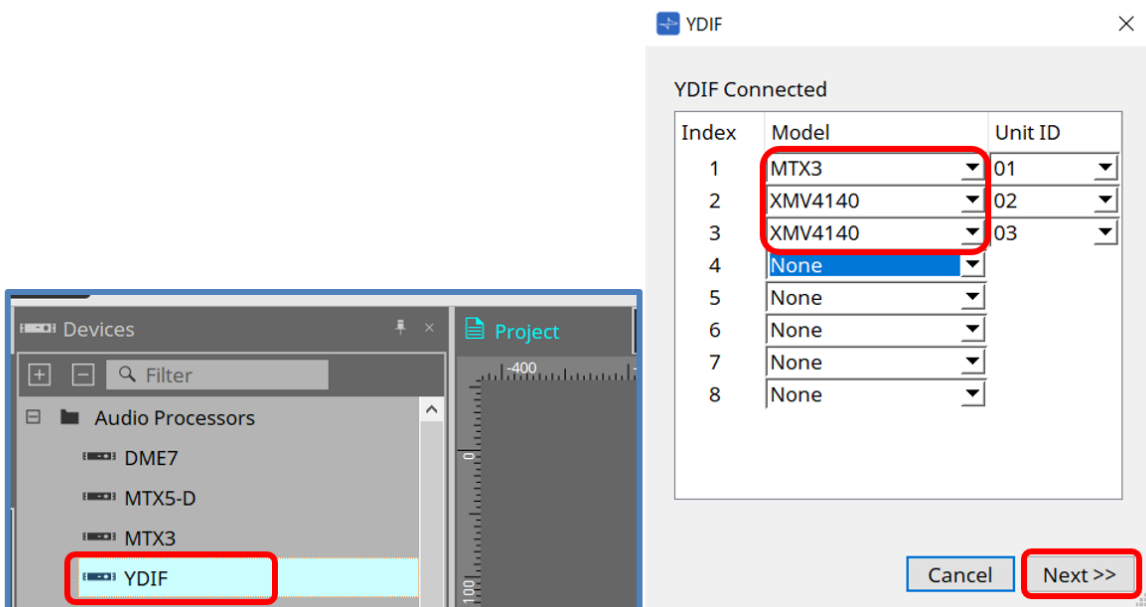

Place the YDIF component in the Device area on the Project sheet. The wizard-based YDIF setting screen will be displayed at this point.

On the YDIF Connected screen, select the Model being used from the pull-down menu and press [Next].

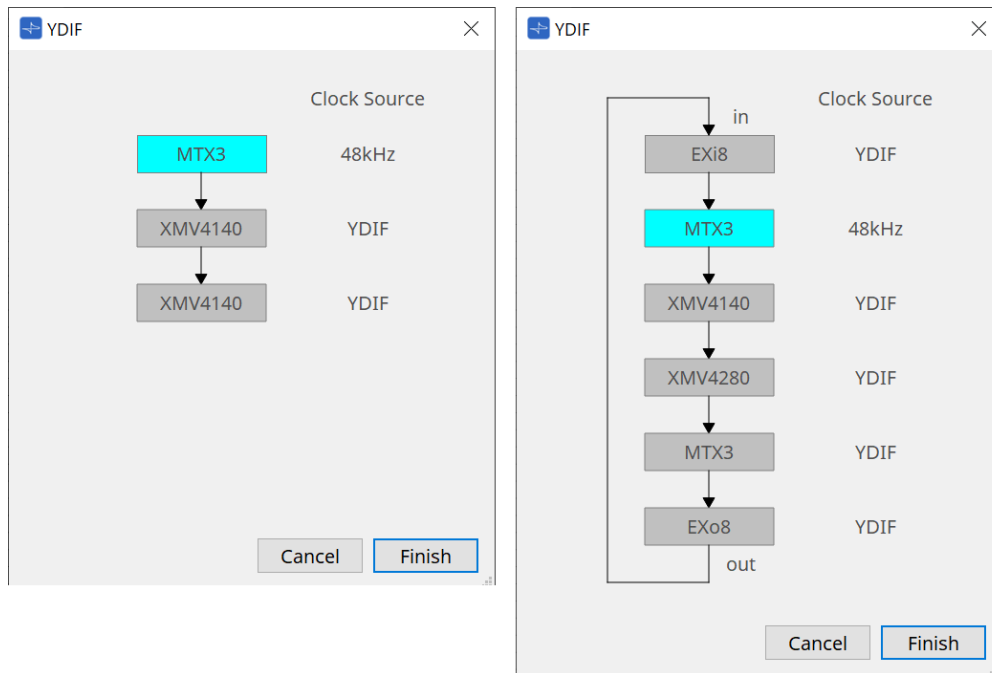

The wiring diagram and the Clock Source will be displayed.

Follow the displayed wiring diagram to connect the actual devices to each other with YDIF cables.

Note that there are two patterns: one in which ring connection is not required (left diagram), and the other in which ring connection is required (right diagram).

When you press the [Finish] button, a YDIF-connected device group will be created in the Project sheet.

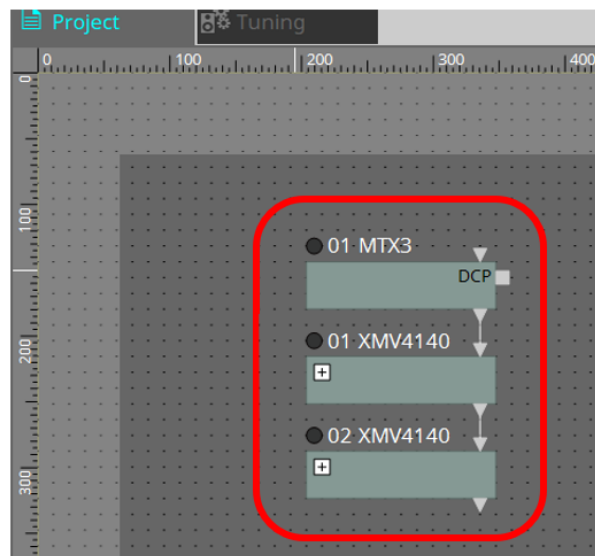

The wizard-based setup has the following two advantages.

- (1) Selecting the wrong combination of devices will prevent the wizard from completing, allowing you to check for misconnections in advance.
- (2) Ring connection decisions are also performed automatically.

Similar settings are also possible by wiring YDIF connectors between devices without using the wizard.

Note that in this case, there will be no warnings about mistaken connections that the wizard provides. In such cases, a ring connection is recommended as usual.



### 29.3. YDIF setting method (device sheets)

Within each device sheet, specify settings such as YDIF Patch and make the settings for the desired routing.

(Example: XMV4140)

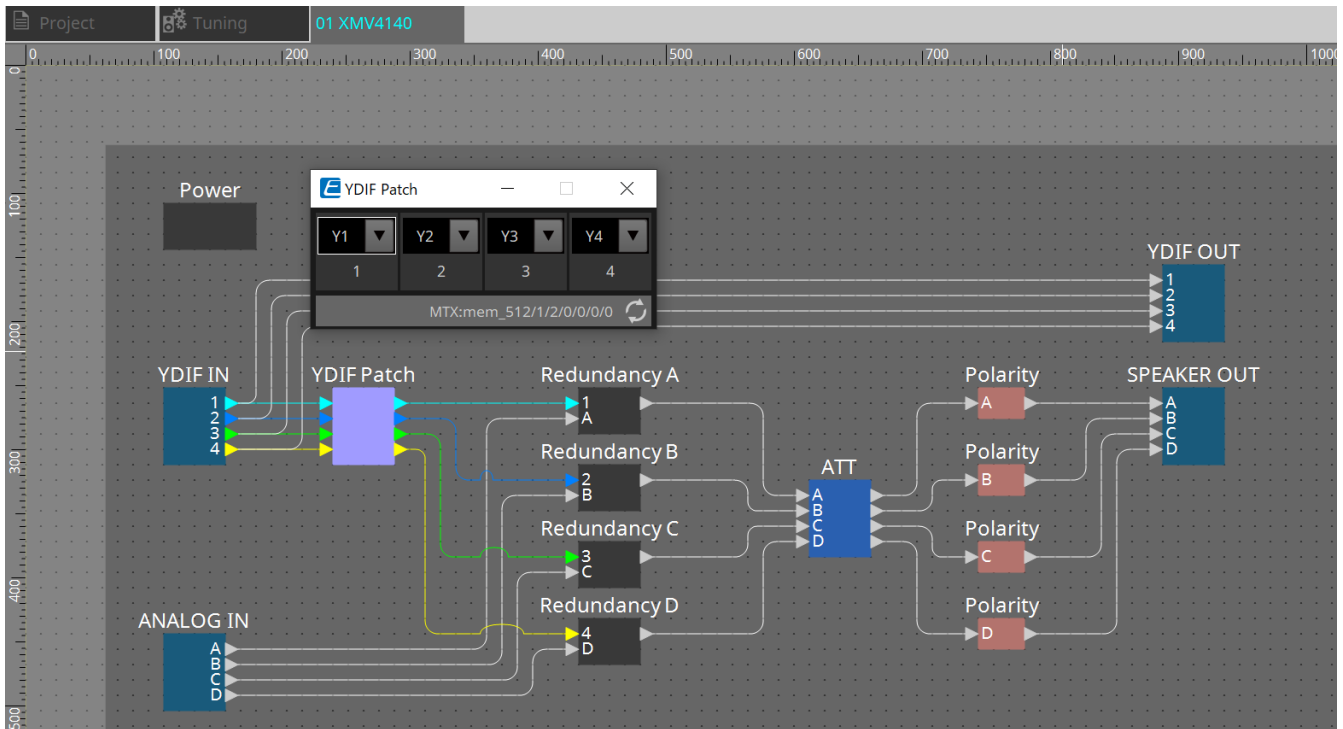

## 30. Settings for controlling devices across subnets

If you are controlling devices on a subnet that is different than that of ProVisionaire Design, all devices are distinguished by their IP address.

For this reason, it is necessary to make settings so that the IP settings of devices placed in ProVisionaire Design (these are called virtual devices) match the IP settings of devices on the network (these are called real devices). The IP settings of virtual devices are made in the **"Match Device by IP Address" dialog box**, and the IP settings of real devices are made in the **"IP Address" dialog box**.

Set the IP addresses so that they are unique for the entire communication path. If devices of the same IP address exist on the communication path, they might not be distinguishable.

First, use the **"Match Device by IP Address" dialog box** to specify IP addresses for the virtual devices.

1. **Place a device in the "Project" sheet.**
2. **In ProVisionaire Design's [System] menu, click [Match Device by IP Address].**  
The **"Match Device by IP Address" dialog box** opens.

Match Devices by IP Address

Set an IP address for the device (virtual device) added to the project.  
ProVisionaire Design will automatically detect network devices that match the virtual device's IP address.

In the IP Setting dialog window, set the IP address of the network device so that it matches the IP address of the virtual device.  
System Menu> IP Settings> Set IP Address> Auto-Assign IP Address.

IP Address Range Finder

IP Address :  .  .  .

Subnet Mask :  ▼

Range :

Default Gateway :  .  .  .

Apply found IP Address Range to the checked devices.

Unit ID	Model	Device Name	IP Address	Subnet Mask	Default Gateway
<input type="checkbox"/> 02	DME7	DME7	<input type="text"/> . <input type="text"/> . <input type="text"/> . <input type="text"/>	<input type="text" value="255.255.255.0"/> ▼	<input type="text"/> . <input type="text"/> . <input type="text"/> . <input type="text"/>
<input type="checkbox"/> 0E	XMV8140	XMV8140	<input type="text"/> . <input type="text"/> . <input type="text"/> . <input type="text"/>	<input type="text" value="255.255.255.0"/> ▼	<input type="text"/> . <input type="text"/> . <input type="text"/> . <input type="text"/>
<input type="checkbox"/> 3A	EXi8	EXi8	<input type="text"/> . <input type="text"/> . <input type="text"/> . <input type="text"/>	<input type="text" value="255.255.255.0"/> ▼	<input type="text"/> . <input type="text"/> . <input type="text"/> . <input type="text"/>
<input type="checkbox"/> 53	XMV8280-D	XMV8280-D	<input type="text"/> . <input type="text"/> . <input type="text"/> . <input type="text"/>	<input type="text" value="255.255.255.0"/> ▼	<input type="text"/> . <input type="text"/> . <input type="text"/> . <input type="text"/>

3. **In "IP Address Range Finder," use the [IP Address] text box to enter a representative IP address of the subnet to which the device to be searched is connected.**
4. **In "IP Address Range Finder," use the [Subnet Mask] list box to select the subnet mask.**
5. **In "IP Address Range Finder," click the [Find Range] button.**  
The valid IP addresses's range is shown in the "Range" field, and an IP address candidate for the default gateway is shown in the [Default Gateway] text box.  
If the default gateway IP address is wrong, edit it.
6. **Check the checkbox of the virtual device for which you want to set the IP address.**
7. **Click the [Apply IP Address] button.**

Match Devices by IP Address

Set an IP address for the device (virtual device) added to the project. ProVisionaire Design will automatically detect network devices that match the virtual device's IP address.

In the IP Setting dialog window, set the IP address of the network device so that it matches the IP address of the virtual device. System Menu> IP Settings> Set IP Address> Auto-Assign IP Address.

IP Address Range Finder

IP Address : 192 . 168 . 100 . 1

Subnet Mask : 255.255.255.0

Find Range

Range : 192.168.100.1 - 192.168.100.254

Default Gateway : 192 . 168 . 100 . 254

Apply IP Address Apply found IP Address Range to the checked devices.

All On All Off All Clear

	Unit ID	Model	Device Name	IP Address	Subnet Mask	Default Gateway
<input checked="" type="checkbox"/>	02	DME7	DME7	192 . 168 . 100 . 1	255.255.255.0	192 . 168 . 100 . 254
<input checked="" type="checkbox"/>	0E	XMV8140	XMV8140	192 . 168 . 100 . 2	255.255.255.0	192 . 168 . 100 . 254
<input checked="" type="checkbox"/>	3A	EXI8	EXI8	192 . 168 . 100 . 3	255.255.255.0	192 . 168 . 100 . 254
<input checked="" type="checkbox"/>	53	XMV8280-D	XMV8280-D	192 . 168 . 100 . 4	255.255.255.0	192 . 168 . 100 . 254

OK Cancel

A static IP address is set for the virtual device.

#### 8. Click the [OK] button.

To assign an IP address to a real device, you can either make settings by operating the real device, or you can use the "IP Address" dialog box to specify an IP address for the real device. Here we will explain how to use the "IP Address" dialog.

Next, we will explain the procedure for setting the IP address set for the virtual device to the real device.

1. **Set the Unit ID of the real device to match the virtual device.**
2. **Connect the real device to the same subnet as ProVisionaire Design so that it can be discovered by ProVisionaire Design.**  
For details, refer to the owner's manual of each device.
3. **While still offline, click [IP Settings] in the [System] menu of ProVisionaire Design.**  
If the "Network Setup" dialog box appears, sselect the same network as ProVisioniare Design.

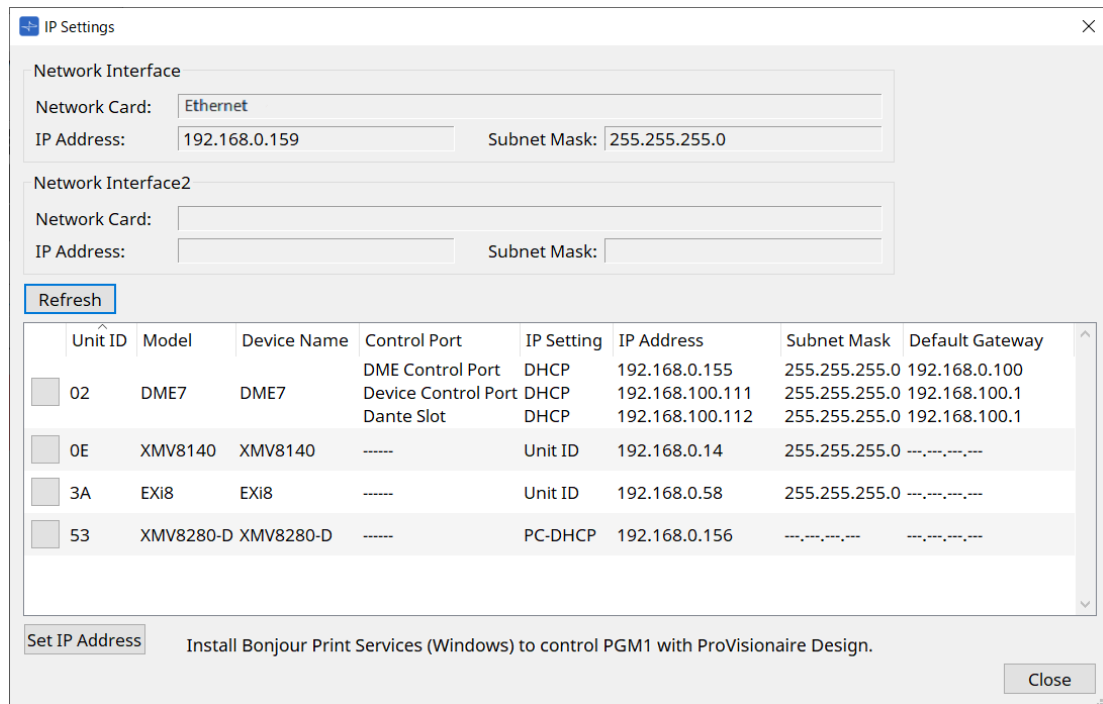

4. When all real devices are shown in the "IP Settings" dialog box, click the [Set IP Address] button. The "IP Address" dialog box opens.

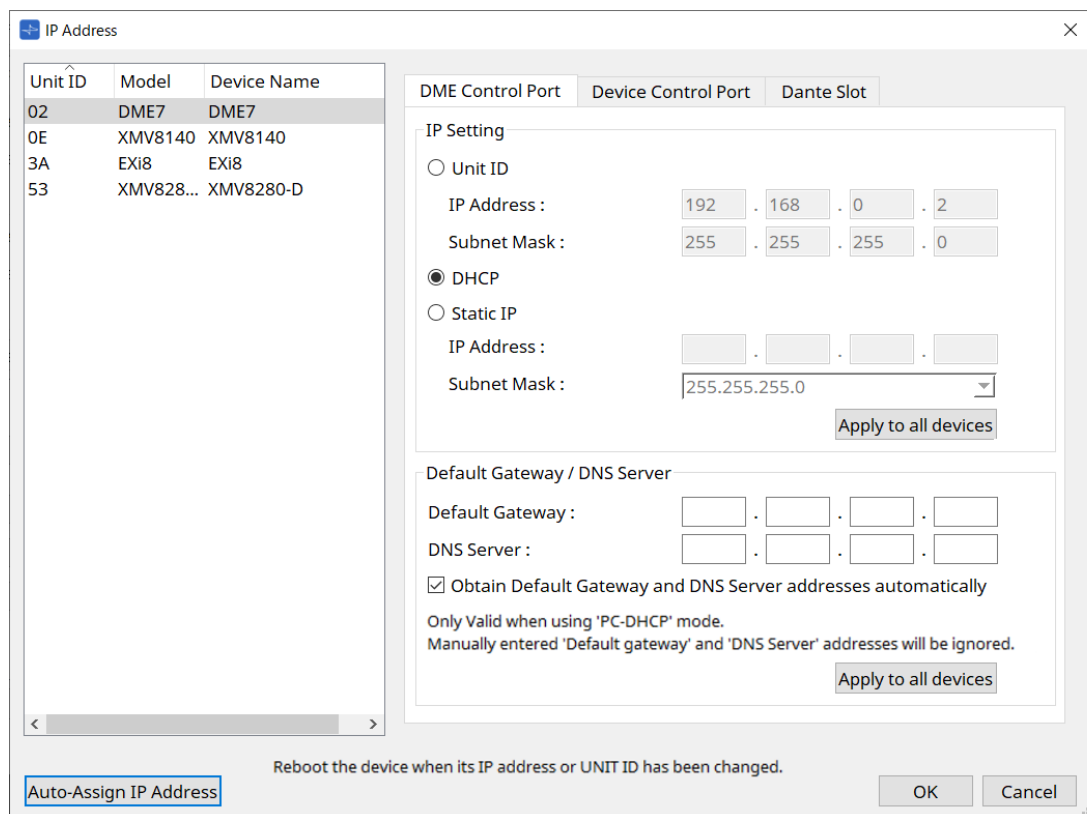

5. Click the [Auto-Assign IP Addresses] button.

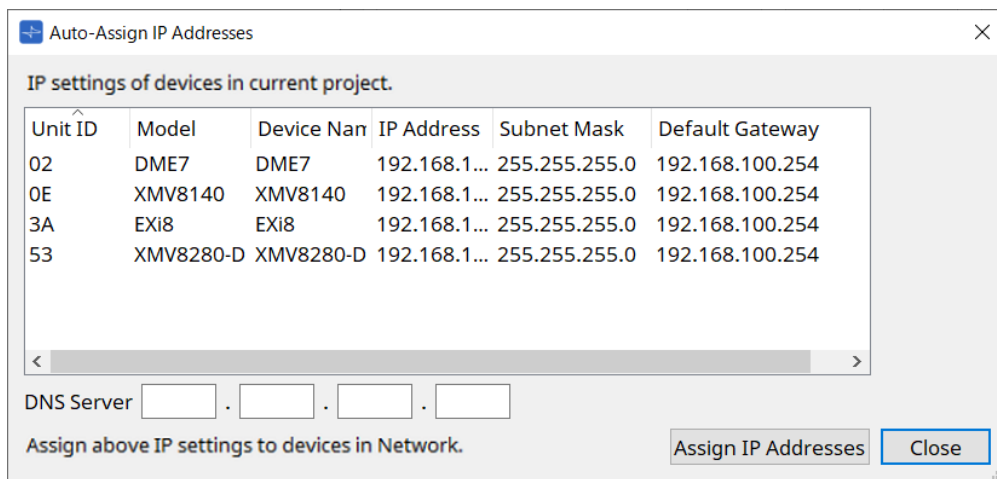

In the Match Device by dialog box, a list of IP addresses set for virtual devices is displayed. Set the DNS Server as required.

6. **Click the [Assign IP Addresses] button.**  
Reflect the settings of the virtual device to the real device whose Model and Unit ID match those of the virtual device.

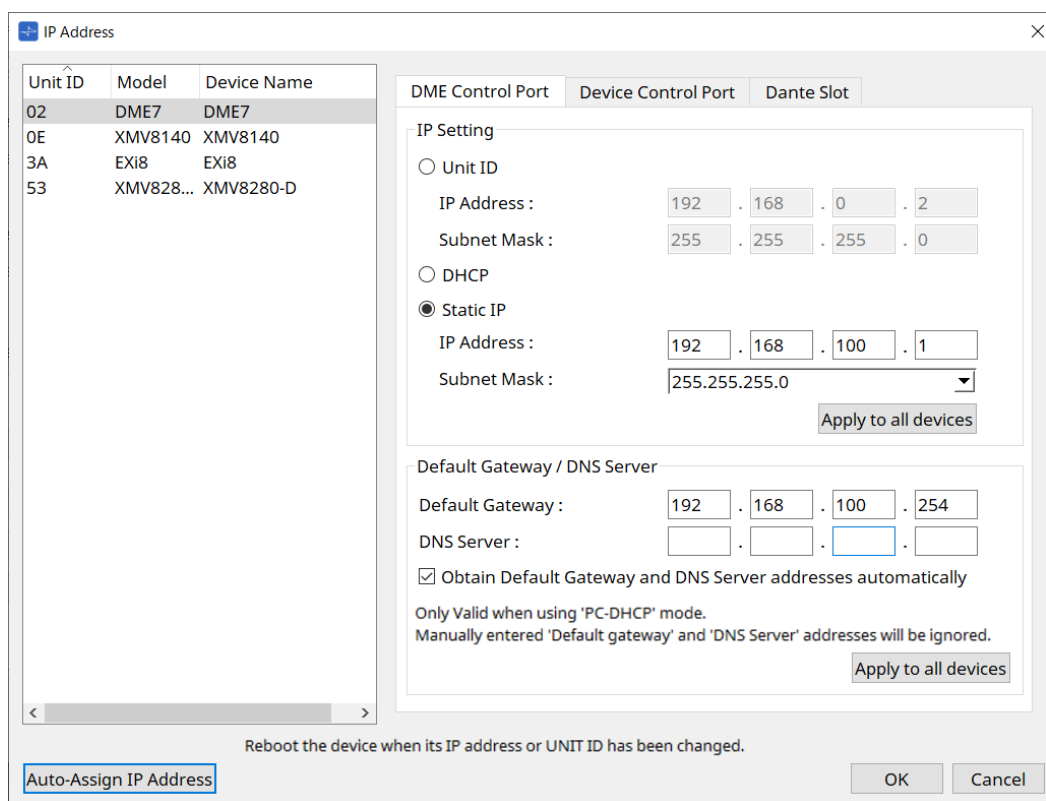

7. **Click the [OK] button.**  
The IP address, subnet mask, and default gateway settings are sent to the real devices.

