

YAMAHA C-80

Natural Sound Stereo Control Amplifier
New Continuously Variable Loudness Control
Super Low-Noise Zero Distortion Rule Head Amp
Zero Distortion Rule / DC Servo / Current Noise Suppression EQ Amp
4-Gang Volume Control
2-Band Parametric Equalizer
Switchable MC / MM Cartridge Gain



OWNER'S MANUAL



Thank you for purchasing the YAMAHA C-80 stereo control amplifier.

CONTENTS

CAUTION (PREPARED IN ACCORDANCE WITH UL STANDARD 1270)	1
CAUTION: READ THIS BEFORE OPERATING YOUR C-80	2
CONNECTION DIAGRAM	3
NAMES OF THE PARTS AND THEIR FUNCTIONS	5
APPLICATIONS	7
TROUBLESHOOTING	8
SPECIFICATIONS	8

IMPORTANT

Please check your unit's serial number on the rear of the cabinet and record it in the space below.

Model: **C-80**

Serial No.:

Keep this owner's manual in a safe place for future reference.

WARNING

To prevent fire or shock hazard, do not expose this appliance to rain or moisture.

CAUTION (PREPARED IN ACCORDANCE WITH UL STANDARD 1270)

1 Read Instructions — All the safety and operating instructions should be read before the appliance is operated.

2 Retain Instructions — The safety and operating instructions should be retained for future reference.

3 Heed Warnings — All warnings on the appliance and in the operating instructions should be adhered to.

4 Follow Instructions — All operating and other instructions should be followed.

5 Water and Moisture — The appliance should not be used near water — for example, near a bathtub, washbowl, kitchen sink, laundry tub, in a wet basement, or near swimming pool, etc.

6 Carts and Stands — The appliance should be used only with a cart or stand that is recommended by the manufacturer.

7 Wall or Ceiling Mounting — The appliance should be mounted to a wall or ceiling only as recommended by the manufacturer.

8 Ventilation — The appliance should be situated so that its location or position does not interfere with its proper ventilation. For example, the appliance should not be situated on a bed, sofa, rug, or similar surface that may block the ventilation openings; or placed in a built-in installation, such as a bookcase or cabinet that may impede the flow of air through the ventilation openings.

9 Heat — The appliance should be situated away from heat sources such as radiators, stoves, or other appliances that produce heat.

10 Power Sources — The appliance should be connected to a power supply only of the type described in the operating instructions or as marked on the appliance.

11 Power-Cord Protection — Power-supply cords should be routed so that they are not likely to be walked on or pinched by items placed upon or against them, paying particular attention to cords at plugs, convenience receptacles, and the point where they exit from the appliance.

12 Cleaning — The appliance should be cleaned only as recommended by the manufacturer.

13 Nonuse Periods — The power cord of the appliance should be unplugged from the outlet when left unused for a long period of time.

14 Object and Liquid Entry — Care should be taken so that objects do not fall into and liquids not spilled into the inside of the appliance.

15 Damage Requiring Service — The appliance should be serviced by qualified service personnel when:

- A. The power-supply cord or the plug has been damaged; or
- B. Objects have fallen, or liquid has been spilled into the appliance; or
- C. The appliance has been exposed to rain; or
- D. The appliance does not appear to operate normally or exhibits a marked change in performance; or
- E. The appliance has been dropped, or the cabinet damaged.

16 Servicing — The user should not attempt to service the appliance beyond those means described in the operating instructions. All other servicing should be referred to qualified service personnel.

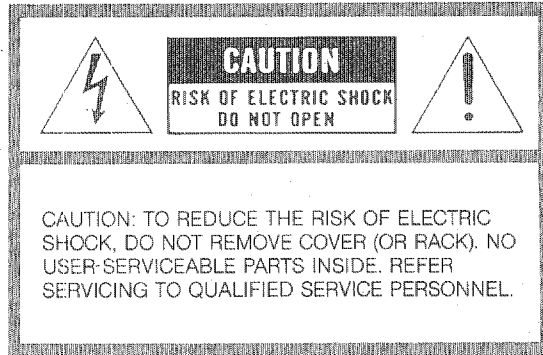

• Explanation of Graphic Symbols

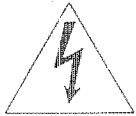

The lightning flash with arrowhead symbol, within an equilateral triangle, is intended to alert you to the presence of uninsulated "dangerous voltage" within the product's enclosure that may be of sufficient magnitude to constitute a risk of electric shock to persons.

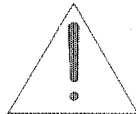

The exclamation point within an equilateral triangle is intended to alert you to the presence of important operating and maintenance (servicing) instructions in the literature accompanying the appliance.

CAUTION: READ THIS BEFORE OPERATING YOUR C-80

1

To ensure the finest performance, please read this manual carefully. Keep it in a safe place for future reference.

2

Install your C-80 in a cool, dry, clean place—away from windows, heat sources, and too much vibration, dust, moisture or cold. Avoid sources of hum (transformers, motors). To prevent fire or electrical shock, do not expose to rain and water.

3

Never open the cabinet. If a foreign object drops into the set, contact your dealer.

4

Do not use force on switches, knobs or cords. When moving the set, first gently disconnect the power plug and the cords connecting to other equipment. Never yank the cords.

5

Always set the volume control to "∞" while lowering the tonearm to play a record; turn the volume up with the stylus in the groove.

6

Do not attempt to clean the C-80 with chemical solvents; this might damage the finish. Use a clean, dry cloth.

7

Be sure to read the "troubleshooting" section on common operating errors before concluding that your C-80 is faulty.

8

Do not connect audio equipment to the AC outlets on the rear panel if that equipment requires more power than the outlets are rated to provide.

C-80

CONNECTION DIAGRAM

Be sure to connect the left (L) and right (R) channels consistently from component to component.

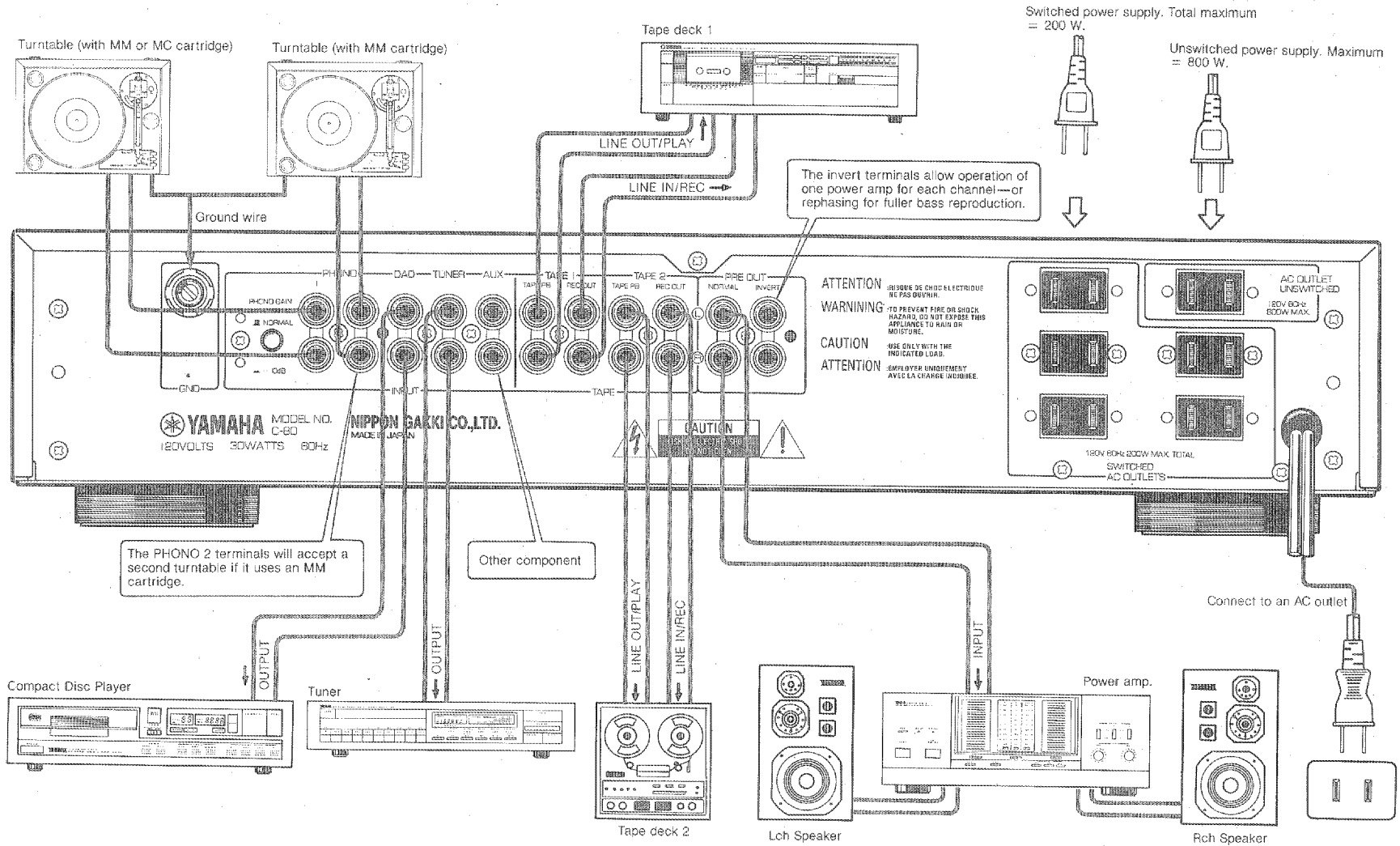

CONNECTING A TURNTABLE

The C-80 accepts two turntables. The PHONO 1 turntable can carry either an MM or an MC cartridge; the PHONO 2 turntable is MM only. The front panel's PHONO rotary switch selects the turntable. The leftmost position selects PHONO 2, which requires an MM cartridge of 47k ohms 220 pf impedance. The five positions to the right are all for PHONO 1: a choice of 3 MM and 2 MC settings is offered.

On the rear panel next to the turntable jacks is the Phono Gain Switch—a small red button. Use this switch to refine volume control with high output level cartridges. Press the button in to lower the output signal by 10 decibels; press again to release the button and return the output signal to normal. Plug each turntable's output cords into the appropriate PHONO jacks. Connect the turntable's ground wire to the Gnd terminal. (This normally produces minimum hum, but in some cases disconnecting the ground wire gives better results.)

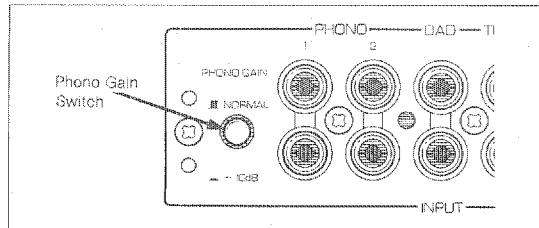

CONNECTING A TUNER

Connect cords from the tuner's OUTPUT jacks to the TUNER jacks of the amplifier.

CONNECTING A TAPE DECK

Two tape decks can be connected to this amplifier's two sets of jacks (TAPE 1 and TAPE 2). Connect the TAPE PB jacks to the tape deck's LINE OUT jacks, and the REC OUT jacks to the deck's LINE IN jacks.

DAD (Digital Audio Disc) TERMINALS

These terminals connect a digital audio compact disc player to the control amplifier. Connect L and R consistently between control amplifier and disc player.

AUX TERMINALS

These terminals can connect a third tape deck (playback only), a second tuner, or other sources. A turntable cannot be connected to the AUX terminals: no RIAA equalization is provided.

AC OUTLETS

For your convenience, the General Model provides 6 AC OUTLETS (5 switched and 1 unswitched) on the rear panel. The maximum power consumption accepted is:

- 5 SWITCHED outlets = 200 watts
- 1 UNSWITCHED outlet = 800 watts

CONNECTING THE POWER AMP

Connect cords from the PRE OUT jacks of the C-80 to the INPUT jacks of your power amplifier.

CONNECTING THE POWER AMP

When using a separate power amplifier for each channel, make the alternate hookup in Fig. 1. This allows you to run ordinary stereo amplifiers (those without inverting pre outs) monaurally. Power amplifiers' supply capacity limits their bass response. When a strong bass note enters both channels of the power amp, total demand for power is high. The PRE OUT INVERT jacks can solve this problem. The hookup shown in Fig. 2, operates the power amp's left and right channels out of phase, greatly reducing the demand on the power supply and in many cases dramatically improving bass reproduction. Be sure to reverse connections to one speaker as shown, to bring output back into phase.

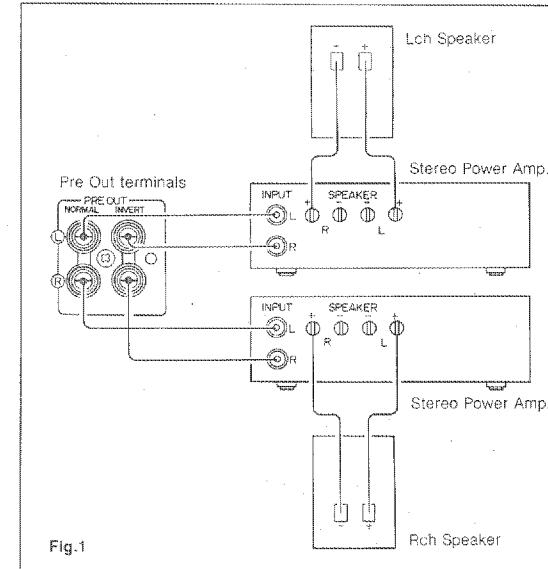

Fig.1

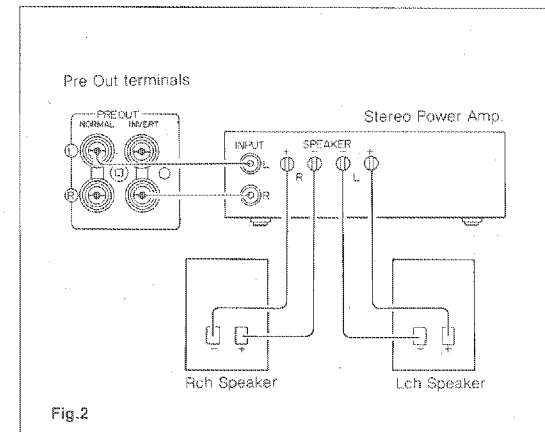
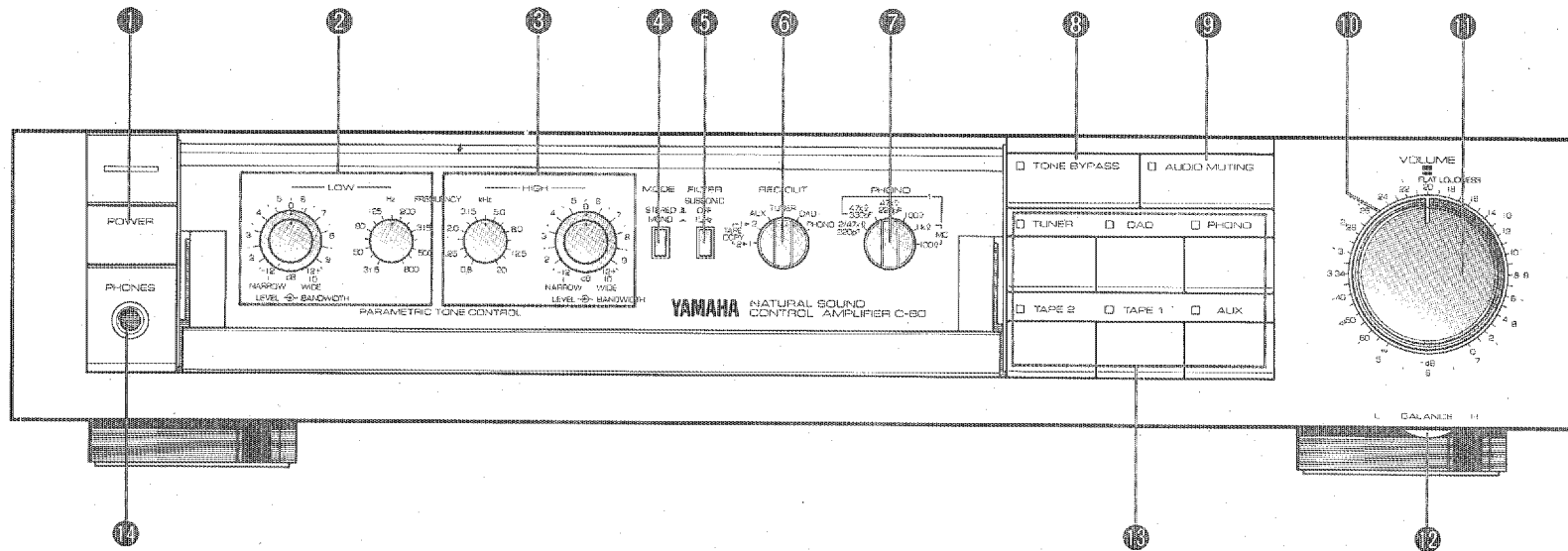

Fig.2

C-80

NAMES OF THE PARTS AND THEIR FUNCTIONS



❶ POWER SWITCH

Push to turn power on or off. Before turning on power, set the VOLUME control all the way down.

■ PARAMETRIC EQUALIZER

❷ EQUALIZER—LOW BAND

The LOW band of the Parametric Equalizer may be used to boost or cut any frequency in the range of 31.5 Hz to 800 Hz by a selectable amount. A range of frequencies is affected, centered on the frequency selected with the FREQUENCY control. The width of the frequency range to be adjusted is set with the BANDWIDTH control. The amount of boost or cut is set with the LEVEL control (-12 dB to +12 dB).

❸ EQUALIZER—HIGH BAND

The HIGH band of the Parametric Equalizer may be used to boost or cut any frequency in the range of 0.8 kHz to 20 kHz by a selectable amount. A range of frequencies is affected, centered on the frequency selected with the FREQUENCY control. The width of the frequency range to be adjusted is set with the BANDWIDTH control. The amount of boost or cut is set with the LEVEL control (-12 dB to +12 dB).

❹ MODE SWITCH

Switches between stereo and mono modes.

❺ SUBSONIC FILTER

This switch cuts out ultra-low-frequency signals caused by warped records or turntable rumble. Subsonic interference drains amplifier power and can even harm speakers if not attenuated.

❻ REC OUT SELECTOR

This switch selects the source for recording. Monitoring the recording source is optional: the input selector switches can be set to the same or a different source from that being recorded. If your tape deck has three-head monitoring capability, you can monitor the just-recorded signal by pressing the corresponding tape input selector switch.

• Independent Recording and Listening Examples

Rec. Out Selector	Input Selector	Action
Tuner	Phono	Listening to a record with the speakers while recording an AM or FM broadcast.
Tuner	Tuner	Listening to an FM or AM broadcast with the speakers while recording it.
Phono	Phono	Listening to a record with the speakers while recording it.
Phono	Tuner	Listening to an FM or AM broadcast with the speakers while recording a record.

• Tape Dubbing

With a tape deck hooked up to each connector (TAPE 1 and TAPE 2), set the REC OUT switch to TAPE COPY position 1 ▶ 2 or 2 ▶ 1. Set the source deck to Play and the receiving deck to Record.

⑦ PHONO TYPE/IMPEDANCE SELECTOR

This rotary switch selects the turntable and impedance. The leftmost position selects PHONO 2, which requires an MM cartridge. The five positions to the right all select PHONO 1: a choice of 3 MM and 2 MC settings is offered.

⑧ TONE BYPASS SWITCH

Press this button to engage Tone Bypass, which routes the input signal so that it is unaffected by the parametric equalizer circuitry. Recommended for phono input.

⑨ AUDIO MUTING SWITCH

Press to lower the volume 20 dB without disturbing the Volume Control position (for taking telephone calls, etc.). Press again to restore normal volume.

⑩ CONTINUOUSLY VARIABLE LOUDNESS CONTROL

This control allows you to retain full tonal range at low volume levels. Your ear loses sensitivity to high and low frequency ranges at low volume settings. Loudness control provides a maximum of 40 dB attenuation, employed according to an equalization curve based on human hearing. Before changing the volume setting, reset the Loudness control to the flat position (notch straight up).

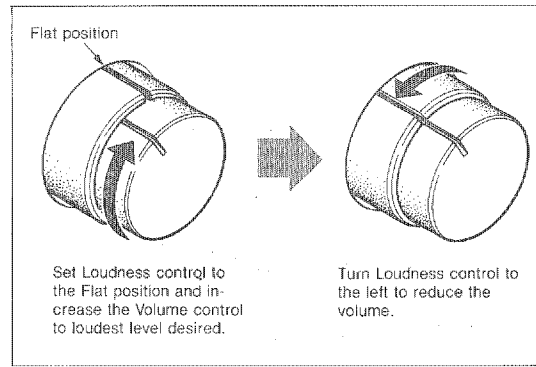

Continuously Variable Loudness Control Characteristics

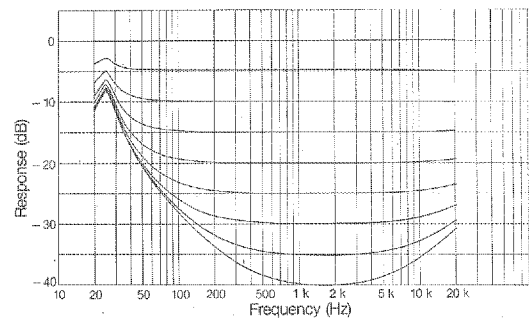

⑪ VOLUME CONTROL

Adjusts overall sound volume. Calibrated in decibels.

⑫ BALANCE CONTROL

This control adjusts the relative volume of the left and right speakers, enabling you to compensate for imbalance caused by asymmetry in speaker locations, furniture arrangement, or in the source program.

⑬ INPUT SELECTOR SWITCHES

These switches select the listening source.

⑭ PHONES JACK

One headphone jack is provided. Plugging in the headphones mutes the audio output to the power amp for private listening.

■ ATTACHING THE RACK MOUNTING ADAPTORS (Optional)

- 1) Remove the screws on the bottom of the unit as shown in the diagram and take off the covers which conceal the adaptor mounting holes. The covers can be removed by sliding them 5 mm down after removing the screws.
 - 2) Verify that the resulting mounting centers of the adaptors will match the width of your rack, then attach the adaptors firmly with screws.
- * Using these adaptors allows the unit to be used with EIA standard racks.

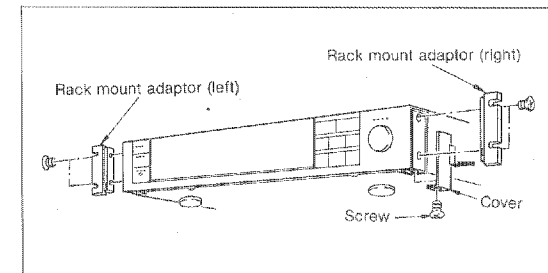

APPLICATIONS

■ PRACTICAL APPLICATIONS OF THE PARAMETRIC EQUALIZER

The C-80's Parametric Equalizer offers extensive control over tone quality. It can be used to adjust for room acoustics, speaker placement, or personal preferences. A LOW band and a HIGH band are provided, each with its own adjustable center frequency, bandwidth, and level (boost/cut).

1) Compensating for Room Acoustics

If a spectrum analyzer or sound level meter is available, you will be able to accurately flatten your listening room's acoustic response using the Parametric Equalizer controls. For example, if a response dip in the high frequency range (often due to sound absorption by carpet, drapes, stuffed furniture or even people) is detected, use the HIGH Parametric Equalizer band to create a corresponding response peak of equal but opposite BANDWIDTH and LEVEL.

If appropriate test instruments are not available, however, rough compensation can be done by ear. For instance, if the bass range sounds too "boomy", indicating a low frequency peak, try setting the LOW range BANDWIDTH to WIDE and the LEVEL control to maximum cut, then sweep the FREQUENCY control through the bass range until you hear the boominess disappear. Then, finally, readjust the BANDWIDTH and LEVEL controls for the most natural overall sound.

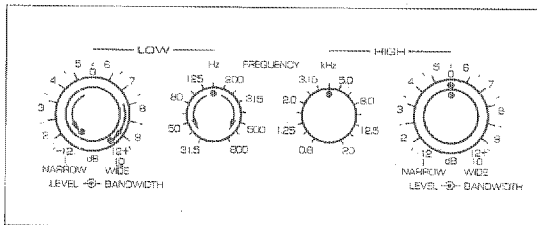

2) Eliminating Noise or Hum

If there is an annoying hum or noise during operation of your system, it can be effectively eliminated using the Parametric Equalizer. In the case of a high-frequency whine, for example, try

setting the HIGH range BANDWIDTH to the maximum NARROW position and the LEVEL control to maximum cut, then sweep the FREQUENCY control through the high frequency range until you hear the interfering frequency noise disappear. Then, finally, readjust the BANDWIDTH and LEVEL controls for the most natural overall sound.

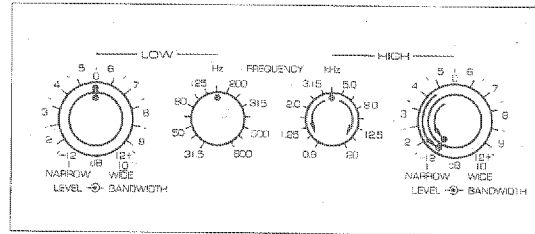

3) Tailoring the Sound

The Parametric Equalizer can also be used to "shape" the sound to emphasize vocals, balance the tonal effect between varying instruments, or create any type of sound you like. Emphasizing the vocals, or mid-range presence, for example, can be done by setting the center FREQUENCY to between 1 kHz and 3 kHz, setting the BANDWIDTH control to the maximum WIDE position, and then boosting the LEVEL slightly. Conversely, vocals or midrange presence can be slightly attenuated by cutting the LEVEL slightly, thereby blending vocals into the background, facilitating conversation over the music or enhancing the background music effect.

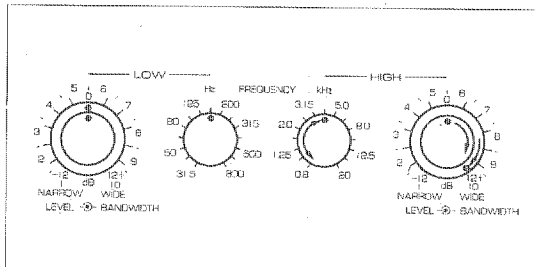

Frequency Control

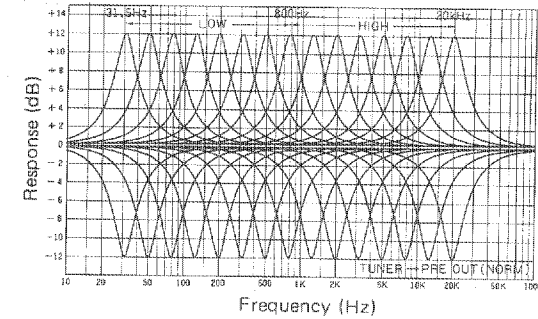

Bandwidth Control

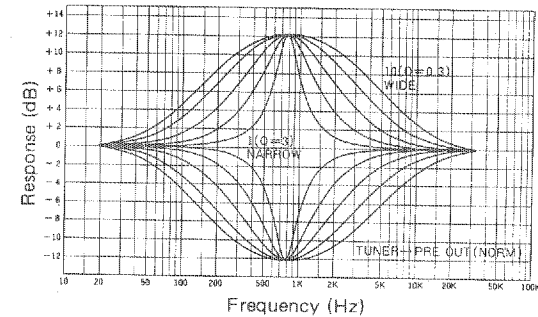

Level Control

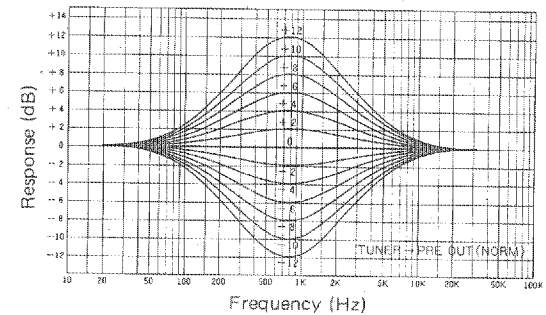

Before assuming that your amplifier is faulty, check the following troubleshooting list which details the corrective action you can take yourself without having to call a service engineer. If you have any doubts or questions, get in touch with your nearest Yamaha dealer.

Fault	Cause	Cure
Power is not supplied even when the Power switch is turned on.	The power plug is not securely plugged in.	Plug it in securely.
No sound is heard.	Input switches set incorrectly. The power amp is not connected correctly. The input terminals are not connected securely.	Set input switches to source you want to hear. Check and secure connections. Connect them securely.
One channel sounds stronger than the other.	The balance control needs adjustment.	Regulate balance with the control located below the knobs for loudness and volume.
Sound from MC cartridge is low.	The Phono rotary switch is set to an MM position.	Set the switch to MC position.
A loud humming sound is heard during record play.	Turntable's ground wire is not connected to amplifier's ground terminal.	Connect the wire. (Sometimes better results can be obtained without the wire.)
Unable to record.	Rec Out selector set improperly.	Set Rec Out to source you are recording.
Volume is too low even when the Volume control is turned up.	The Audio Mute switch is on.	Turn the Audio Mute switch off.

SPECIFICATIONS

Input Sensitivity/Impedance

Phono MC.....100 μ V/100 ohms, 1 k-ohms
MM.....2.5 mV/100 ohms, 47 k-ohms
(220, 330 pF)

DAD, Aux, Tape, Tuner150 mV/47 k-ohms

Output Level/impedance

Pre Out1.5 V/47 ohms

Rec Out150 mV/600 ohms

THD (20-20,000 Hz)

Phono MC to Rec Out, 3 V0.001%

Phono MM to Rec Out, 3 V.....0.001%

DAD, Aux, Tape, Tuner to Rec Out, 3 V0.001%

Frequency Response

DAD, Aux, Tape, Tuner.....20 to 20,000 Hz +0 -0.2 dB

RIAA Deviation

Phono MC, MM20 to 20,000 Hz \pm 0.2 dB

Phono MC, MM10 to 100,000 Hz \pm 0.5 dB

Signal to Noise Ratio

Phono MC (500 μ V, Input Shorted).....91 dB

Phono MM (5.0 mV, Input Shorted).....95 dB

DAD, Aux, Tape, Tuner (150 mV, Input Shorted)106 dB

Power Supply

AC 120 V/60 Hz

Power Consumption

30 W

Dimensions (W x H x D)

435 x 95 x 380 mm

(17-1/8" x 3-3/4" x 14-15/16")

Weight

6.8 kg

(14 lbs. 15 oz.)

Specifications subject to change without notice.

SINCE 1887  **YAMAHA**
NIPPON GAKKI CO., LTD. HAMAMATSU, JAPAN

BWgY,G Printed in Japan ©