



IN-CEILING SPEAKER
ENCEINTE ENCASTRABLE POUR PLAFOND

NS-IC600/NS-IC800

OWNER'S MANUAL
MODE D'EMPLOI
BEDIENUNGSANLEITUNG
MANUALE DI ISTRUZIONI
MANUAL DE INSTRUCCIONES
ИНСТРУКЦИЯ ПО ЭКСПЛУАТАЦИИ
使用说明书

CONSUMER PRECAUTIONS

Read these precautions carefully before setting up your NS-IC600/NS-IC800 speakers.

- When mounting these speakers, be sure to work with two or more persons for safety.
- Do not attach them to thin plywood or soft ceiling surface materials as the screws may tear free, causing the speakers to fall and become damaged, or result in personal injury.
- Do not fasten the speakers to a ceiling with nails, adhesives, or other unsafe hardware. Long-term use and vibrations may cause them to pull free.
- Do not place the speakers where they are liable to be knocked over or struck by falling objects. Stable placement will also ensure better sound performance.
- Do not attempt to modify or fix the speakers. Contact qualified Yamaha service personnel when any service is needed.
- Do not attempt to clean the speakers with chemical solvents as this might damage the finish. To clean, wipe with a dry, soft cloth.
- **Secure placement or installation is the owner's responsibility. Yamaha shall not be liable for any accident caused by improper placement or installation of speakers.**

Information for Users on Collection and Disposal of Old Equipment



This symbol on the products, packaging, and/or accompanying documents means that used electrical and electronic products should not be mixed with general household waste.

For proper treatment, recovery and recycling of old products, please take them to applicable collection points, in accordance with your national legislation and the Directives 2002/96/EC.

By disposing of these products correctly, you will help to save valuable resources and prevent any potential negative effects on human health and the environment which could otherwise arise from inappropriate waste handling.

For more information about collection and recycling of old products, please contact your local municipality, your waste disposal service or the point of sale where you purchased the items.

[Information on Disposal in other Countries outside the European Union]

This symbol is only valid in the European Union. If you wish to discard these items, please contact your local authorities or dealer and ask for the correct method of disposal.

Limited Guarantee for European Economic Area (EEA) and Switzerland

Thank you for having chosen a Yamaha product. In the unlikely event that your Yamaha product needs guarantee service, please contact the dealer from whom it was purchased. If you experience any difficulty, please contact Yamaha representative office in your country. You can find full details on our website (<http://www.yamaha-hifi.com/> or <http://www.yamaha-uk.com/> for U.K. resident).

The product is guaranteed to be free from defects in workmanship or materials for a period of two years from the date of the original purchase. Yamaha undertakes, subject to the conditions listed below, to have the faulty product or any part(s) repaired, or replaced at Yamaha's discretion, without any charge for parts or labour. Yamaha reserves the right to replace a product with that of a similar kind and/or value and condition, where a model has been discontinued or is considered uneconomic to repair.

Conditions

1. The original invoice or sales receipt (showing date of purchase, product code and dealer's name) MUST accompany the defective product, along with a statement detailing the fault. In the absence of this clear proof of purchase, Yamaha reserves the right to refuse to provide free of charge service and the product may be returned at the customer's expense.
2. The product MUST have been purchased from an AUTHORISED Yamaha dealer within the European Economic Area (EEA) or Switzerland.
3. The product must not have been the subject of any modifications or alterations, unless authorised in writing by Yamaha.
4. The following are excluded from this guarantee:
 - a. Periodic maintenance and repair or replacement of parts due to normal wear and tear.
 - b. Damage resulting from:
 - (1) Repairs performed by the customer himself or by an unauthorised third party.
 - (2) Inadequate packaging or mishandling, when the product is in transit from the customer. Please note that it is the customer's responsibility to ensure the product is adequately packaged when returning the product for repair.
 - (3) Misuse, including but not limited to (a) failure to use the product for its normal purpose or in accordance with Yamaha's instructions on the proper use, maintenance and storage, and (b) installation or use of the product in a manner inconsistent with the technical or safety standards in force in the country where it is used.
 - (4) Accidents, lightning, water, fire, improper ventilation, battery leakage or any cause beyond Yamaha's control.
 - (5) Defects of the system into which this product is incorporated and/or incompatibility with third party products.
 - (6) Use of a product imported into the EEA and/or Switzerland, not by Yamaha, where that product does not conform to the technical or safety standards of the country of use and/or to the standard specification of a product sold by Yamaha in the EEA and/or Switzerland.
5. Where the guarantee differs between the country of purchase and the country of use of the product, the guarantee of the country of use shall apply.
6. Yamaha may not be held responsible for any losses or damages, whether direct, consequential or otherwise, save for the repair or replacement of the product.
7. Please backup any custom settings or data, as Yamaha may not be held responsible for any alteration or loss to such settings or data.
8. This guarantee does not affect the consumer's statutory rights under applicable national laws in force or the consumer's rights against the dealer arising from their sales/purchase contract.

CONTENTS

| | | | |
|-----------------------------------|---|---|---|
| CONSUMER PRECAUTIONS | 1 | CONNECTING YOUR AMPLIFIER/RECEIVER | 6 |
| CONTENTS | 2 | Connections..... | 6 |
| PREPARATION | 2 | How to connect..... | 6 |
| Optimum installation layout..... | 2 | After connecting..... | 6 |
| INSTALLATION | 3 | PAINTING THE SPEAKER GRILLE | 6 |
| Before installation | 3 | SPECIFICATIONS | 6 |
| How to install..... | 4 | | |

PREPARATION

Unpacking

After unpacking, check that the following items are contained.

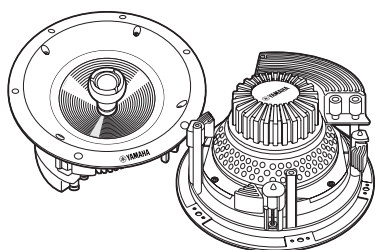

NS-IC600/NS-IC800
Speaker × 2

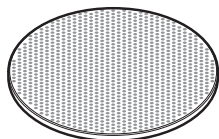

Speaker grille × 2

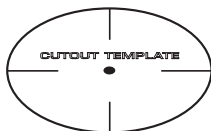

Cutout template × 1

Tools needed for installation

When installing the speakers to the ceiling, you will need to prepare the following tools.

* Use an appropriate tool for the material of the mounting surface.



Pencil

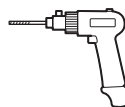

Drill

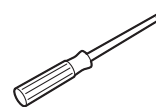

Philips
screwdriver



Wire strippers



Safety goggles



Keyhole saw



Sturdy wire
(such as a coat hanger)



Gloves

Optimum installation layout

Placing the speakers too close to a CRT-type TV may impair the picture color or cause a buzzing noise. In this case, move the speakers away from the TV. This is not an issue with LCD and plasma TVs.

Stereo

For best stereo performance, install the left and right speakers at equal distance from the listening position. Each speaker should be separated by a distance of 1.8 – 3.0 m (6 – 10 ft).

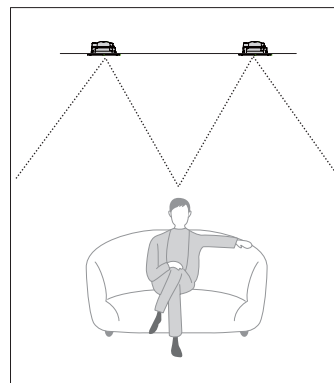

Home Theater (when using as surround speakers)

Use these speakers for left and right surround channels. Surround speakers should ideally be placed behind the listening area, at least as far apart as the front speakers and up to 60 additional centimeters (2 additional feet) apart per side.

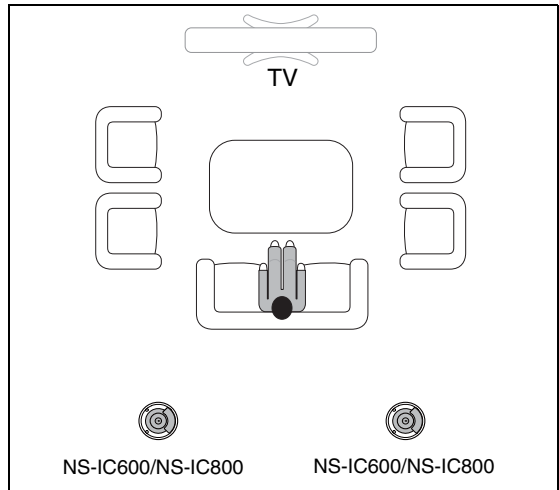

INSTALLATION

Before installation

The following is the recommended procedure for installing the speakers in a ceiling. Please read it carefully before installation.

- Before you begin installation, read this owner's manual completely and consult your local building codes. If you have any doubt, contact your dealer or a qualified audio/video installer.
- Before installing the speakers, run the speaker cables to the installation location.

Ceiling board thickness and clearance space above ceiling

- Check to ensure that the area you are installing the speaker is free of any ceiling joints or studs by tapping the ceiling or using a stud finder.
- Make sure that there is sufficient space on the ceiling for installation and that there are no obstructions such as ducts, pipes, etc. See the following chart for external product dimensions and ceiling installation measurements.
- The thickness required for the ceiling boards is 5 – 30 mm (1/4" – 1-1/8").

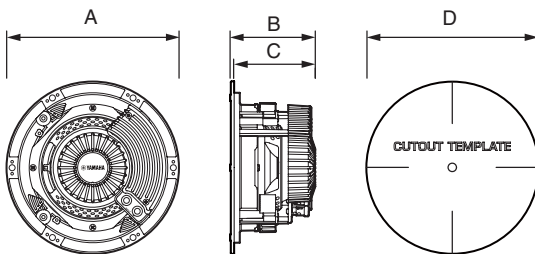

| | NS-IC600 | NS-IC800 |
|------------|-------------------|--------------------|
| Diameter A | φ 231 mm (9-1/8") | φ 272 mm (10-3/4") |
| Depth B | 113.5 mm (4-1/2") | 113.5 mm (4-1/2") |
| Depth C | 109 mm (4-1/4") | 109 mm (4-1/4") |
| Diameter D | φ 204 mm (8") | φ 245 mm (9-5/8") |

* The size differs depending on the model. Refer to the above chart.

- When installing your NS-IC600/NS-IC800 in-ceiling speakers, be aware of the product weight (See specification page) and the sturdiness of the material into which you are installing the speaker.
- Be aware of any concealed studs, electrical wiring or plumbing in the ceiling into which you are installing the speakers. If you are not sure of a safe way to install these speakers, consult a professional installer or a building contractor.

CAUTION

- When installing the speaker, do not touch the woofer or tweeter units with your hands or expose them to excessive physical shock. If they are dented or bent, the sound will be distorted.

NOTE

- If you wish to paint the speaker grille, refer to page 6 "PAINTING THE SPEAKER GRILLE" before proceeding.

How to install

This is the recommended installation procedure when the material of the installation location is plasterboard.

- 1** Position the cutout template where you are installing the speaker.
- 2** Trace a line around the template with a pencil. The mark for the center of the hole is also required.

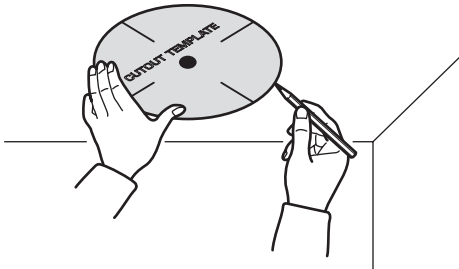

- 3** Drill the pilot hole at the center mark made on the ceiling.

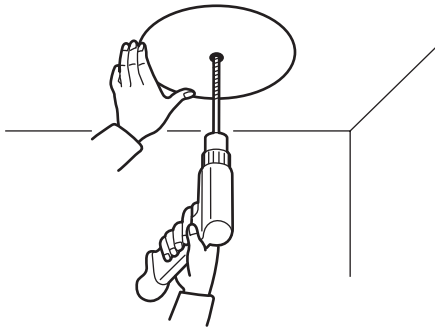

WARNING

- When using a drill or cutting tool, use safety goggles for eye protection and be sure to observe all safety precautions.

- 4** To check the space behind the hole, insert a bent sturdy wire (such as a coat hanger) into the hole, and then slowly rotate the wire to check for any obstruction.
 - If there is any obstruction, patch the hole and select another location.

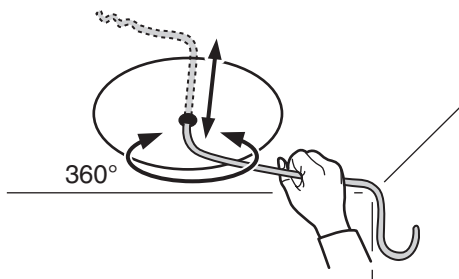

- 5** Insert the tip of a keyhole saw into the pilot hole, and then cut all of the way around the circular outline.

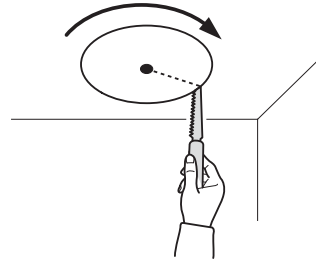

WARNING

- When using a keyhole saw or cutting tool, use safety goggles for eye protection and be sure to observe all safety precautions.

- 6** Pull the speaker cable out of the hole which you have cut.
 - Leave some extra length of cable when pulling the cable out.

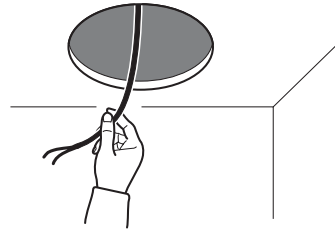

- 7** Connect the speaker cable to the speaker.
 - For detailed instructions, refer to page 6 "CONNECTING YOUR AMPLIFIER/RECEIVER".

- 8** Place the speaker into the ceiling.

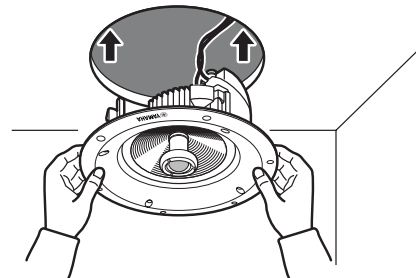

CAUTION

- When installing the speaker, do not touch the tweeter dome or woofer cone directly. This may cause a malfunction.
- Make sure that mounting clamps are turned inward when installing the speaker in a ceiling.

- 9** Insert the speaker into the hole. Loosen four screws approximately one turn counter-clockwise. It will allow the clamps to open easily.

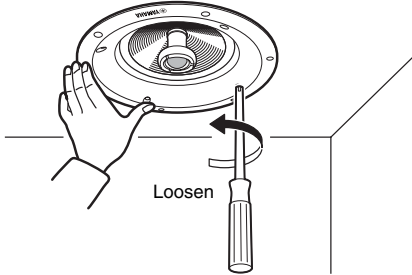

Evenly tighten each of the four mounting screws clockwise using a Philips screwdriver. (At this time, these four mounting clamps open in the ceiling. These opened clamps will press the ceiling board and the speaker together to secure the speaker.) Tighten screws until the mounting clamps sufficiently grip the ceiling. Tighten the screws firmly to secure the speaker to the ceiling.

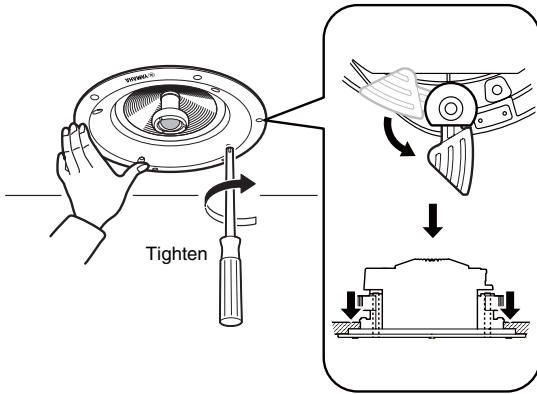

CAUTION

- When tightening the screws, do not screw too tightly. This may cause breakage of the mounting clamps and fracture of the wallboard.
- We recommend using only hand tools as power screwdrivers may over-tighten the screws. Should you use a power screwdriver be certain to select a very low torque setting to prevent damage to the speaker or to the wallboard.
- Make sure that none of the screws are loose and that there are no gaps between the speaker and the ceiling.

HINT

- Tighten the screws in order of opposite sides rather than clockwise or counter-clockwise direction (such as right and left, then top and bottom).

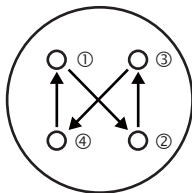

- 10** Adjust the angle of the tweeter.

- Gently press the outer edge of the tweeter housing toward the listening position.
- This tweeter movable angle is about 15° in multiple directions.

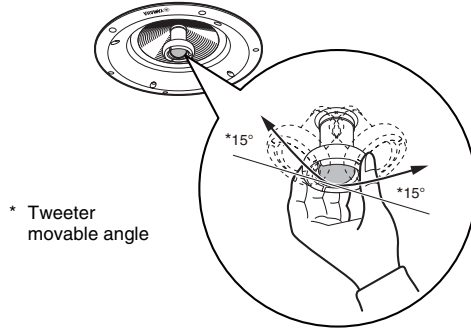

CAUTION

- When adjusting the tweeter, do not rotate it. This may cause the breakage of the tweeter.

- 11** Attach the speaker grille to the speaker.

- As several magnets are on the speaker frame, attach the grille to the frame directly. When attaching the grille, make sure that the grille is attached to the speaker securely to keep the grille from falling.

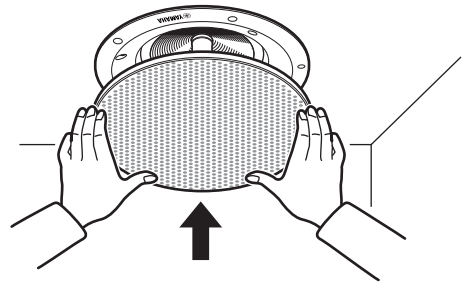

CAUTION

- Be very careful when removing the grille, as it may fall or cause injury. Also, try to place an equal amount of pressure on the circumference when removing the grille. The grille may bend if too much pressure is placed in one location.

CONNECTING YOUR AMPLIFIER/RECEIVER

Before making connections, make sure that the amplifier/receiver is switched off.

- When connecting, also refer to the owner's manual of the connected equipment.

Connections

- Connect the push input terminals at the rear of the speakers to the speaker output terminals of the amplifier/receiver with the speaker cables (not included).
- Connect each speaker making sure not to reverse the polarity "+" (red), "-" (black). If the speaker is connected with reversed polarity, the sound will be unnatural and lack bass.

How to connect

- 1 Remove approximately 10 mm (3/8") of insulation from the end of each speaker cable using wire strippers, and then twist the exposed wires of the cable together to prevent short circuits.
- 2 Press and hold down the speaker terminal.
- 3 Insert the bare wire into the hole in the side of each terminal.

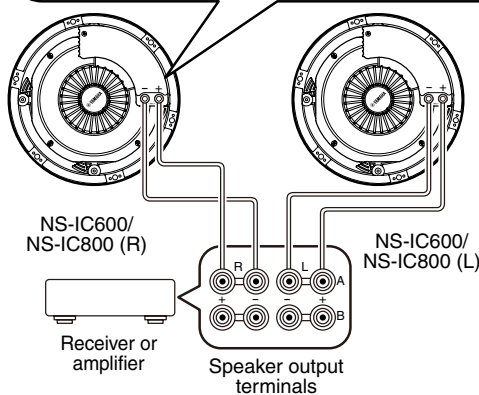
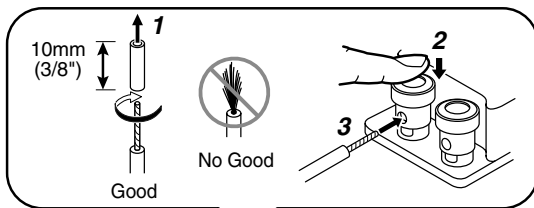

- 4 Release the terminal.
 - Test the firmness of the connection by pulling lightly on the cable at the terminal.

CAUTION

- Do not let the bare speaker wires touch each other as this could damage the speaker or amplifier/receiver, or both.

After connecting

- Lower the power amplifier/receiver volume control before changing input sources. Never change input sources (for example, FM to CD) at high listening levels. Always turn the receiver/amplifier unit off when installing or removing any cables.
- Anytime you note distortion, reduce the volume control on your power amplifier/receiver to a lower setting. Never allow your power amplifier to be driven into "clipping".

PAINTING THE SPEAKER GRILLE

The speaker grilles can be painted to match your room décor. Use high quality spray paint and select a well ventilated area before proceeding.

- 1 Carefully remove the grille from the speaker if attached.
- 2 Remove the scrim cloth that is attached to the back of the grille. (The adhesive that holds the cloth in place is reusable.)
- 3 Apply the paint to the grille.
 - Make sure that the grille holes remain free of paint.
 - Clogging the holes with paint may diminish the sound quality.
- 4 When the paint has fully dried, re-attach the scrim cloth to the back of the grille.
- 5 Re-install the grille on the speaker.

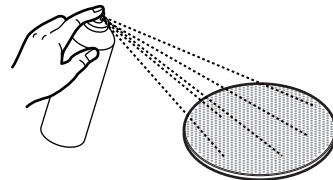

SPECIFICATIONS

| | | NS-IC600 | NS-IC800 |
|--------------------------|------------------------------------|----------------------------|-------------------------------------|
| Type | 2-way Open back type | | |
| Driver | Tweeter | 2.5 cm (1") Soft dome type | |
| | Woofer | 16 cm (6.5") Cone type | 20 cm (8") Cone type |
| Frequency response | 65 Hz to 28 kHz (-10dB) | | 50 Hz to 28 kHz (-10 dB) |
| Impedance | 8 ohms | | |
| Nominal input | 40 W | | 50 W |
| Maximum input | 110 W | | 140 W |
| Sensitivity | 90 dB / 2.83 V, 1 m | | |
| Crossover frequency | 3.2 kHz | | 3.5 kHz |
| Dimensions (with grille) | φ242 × 119D mm (φ9-1/2" × 4-5/8"D) | | φ283 × 120D mm (φ11-1/8" × 4-3/4"D) |
| Weight (with grille) | 1.5 kg (3.3 lbs) | | 1.9 kg (4.2 lbs) |

* Specifications subject to change without notice due to product improvements.

* Speaker cables are not included with this model.

