



Network CD Receiver

CRX-N560

OWNER'S MANUAL

MANUAL DE INSTRUCCIONES

使用说明书

사용 설명서

English

Español

中文

한국어

Read the supplied booklet "Safety Brochure" before using the unit.
Lea el "Folleto de seguridad" que se proporciona antes de utilizar la unidad.
在使用本机前，请阅读随附的小册子“安全手册”。
본 장치를 사용하기 전에 제공된 소책자 "안전 지침서"를 읽으십시오.

Made for
 iPod  iPhone  iPad



TKLV

Contents

Introduction.....4

Supplied accessories.....4
About this manual.....4

Part name.....5

Front panel.....5
Rear panel.....6
Front panel display.....7
🔍 Adjusting display brightness.....7
Remote control.....8

Preparations.....9

Connecting the speakers.....9
Connecting antenna.....10
Connecting to the network.....11
Turning on the power.....12

Setting the network devices.....13

PC.....13
NAS.....13
Mobile devices.....13

Listening to CD.....14

Listening to iPod/USB devices.....15

Playing iPod.....15
Playing USB devices.....15

Listening to the songs in the computer.....17

Setting the media sharing of music files.....17
Playing back songs in the PC.....18

Listening to external sources.....19

More on playback.....20

Shuffle playback.....20
Repeat playback.....20
Playback information.....21
Adjusting sound quality.....22

Listening to FM radio stations.....23

Tuning in FM stations.....23
Presetting FM stations.....23
Selecting preset FM stations.....24
🔍 Deleting a preset station.....24

Listening to Internet radio.....25

Listening to the Music with AirPlay.....26

Playing iPod.....26
Playing iTunes.....26

Using the clock.....27

Setting the clock.....27
Setting the wake-up timer.....28
Sleep timer.....29

Updating the firmware.....30

Option settings.....31

Option menu list.....32

Troubleshooting.....33

General.....33
Network.....34
iPod.....35
Disc.....36
USB devices.....36
FM reception.....37
Messages on the front panel display.....38

Supported devices/media and file formats.....39

Specifications.....41

Information about software.....i

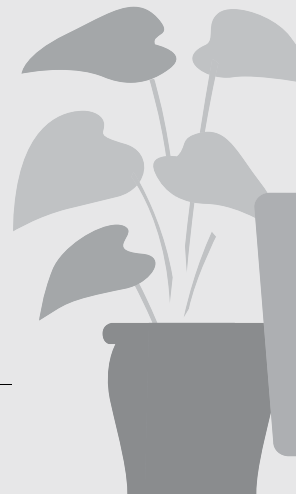

Awesome! Great sound!!

The sound from a PC is something else!.....17, 18

High-resolution sound is played back.....22

Anytime, anywhere, music!

Convenient App! My smartphone as a remote control18

Songs in my iPhone from speakers wirelessly.....26

More on music

A variety of external devices (Blu-ray/DVD/mobile music player etc.) can be connected..... 19

I can listen to the internet radio from my audio system..... 25

Introduction

Confirm the package contents and useful points of this manual.

Supplied accessories

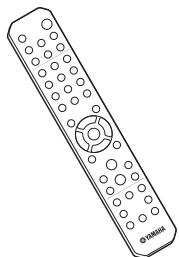

Remote control

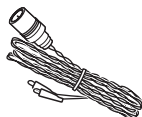

FM antenna

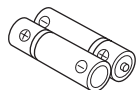

Batteries (× 2)
(AA, R6, UM-3)

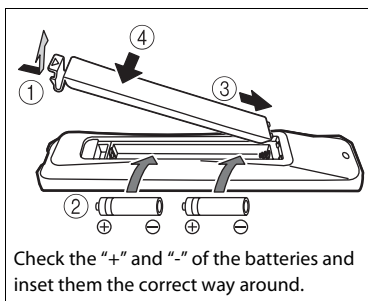

About this manual

- How to operate this unit is described mainly using the remote control.
- Illustrations may differ from actual item depicted.
- "iPod" described in this manual may also refer to "iPhone" or "iPad."
- Symbols:
 - ! Indicates precautions for use of the unit and its feature limitations.
 - 💡 Indicates supplementary explanations for better use.
 - 👉 Indicates the corresponding reference page(s).



- Change both batteries when the operation range of the remote control decreases.

Part name

Familiarize yourself with all parts and these functions.

Front panel

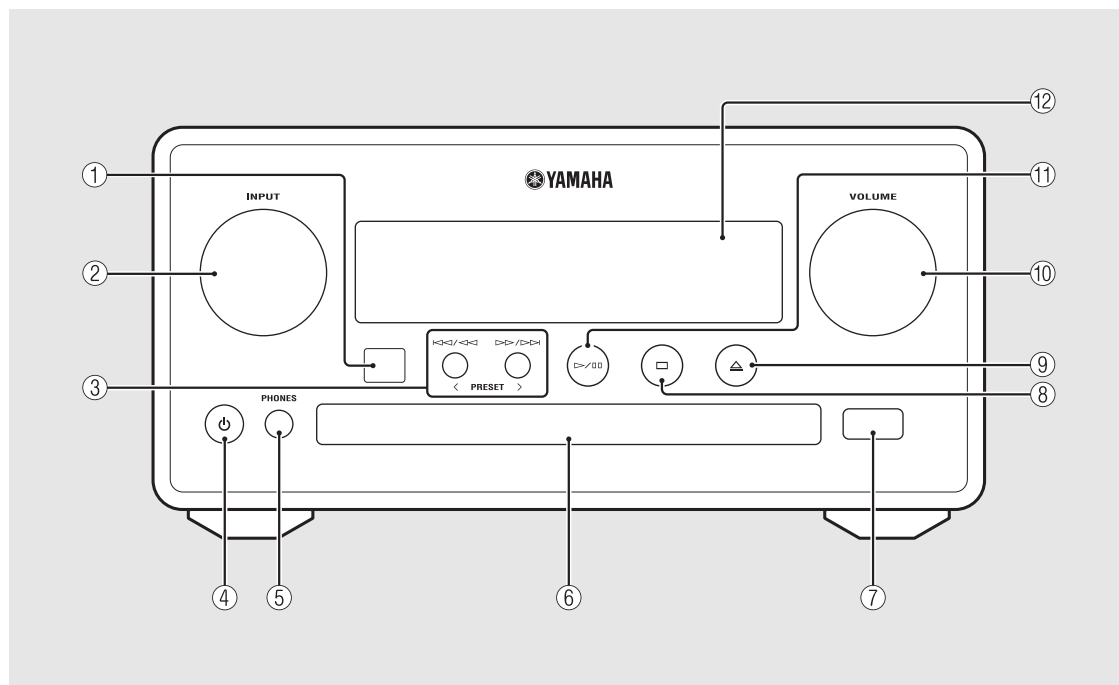

- ① **Remote control receiver**
- ② **INPUT**
Turn left or right to change the audio source. (The source is shown on the front panel display.)
- ③ **⏮/⏪ ⏩/⏭ (P.14, 16, 18)**
PRESET</> (P.24)
- ④ **⏻ (Power) (P.12)**
- ⑤ **PHONES**
Connect headphones to this jack.
- ⑥ **Disc tray (P.14)**
- ⑦ **USB jack (P.15)**
- ⑧ **⏹ (Stop) (P.14, 16, 18, 25)**
- ⑨ **⏏ (Open/close the disc tray) (P.14)**
- ⑩ **VOLUME**
Controls the volume.
- ⑪ **▶/⏸ (Play/pause) (P.14, 16, 18)**
- ⑫ **Front panel display (P.7)**

Rear panel

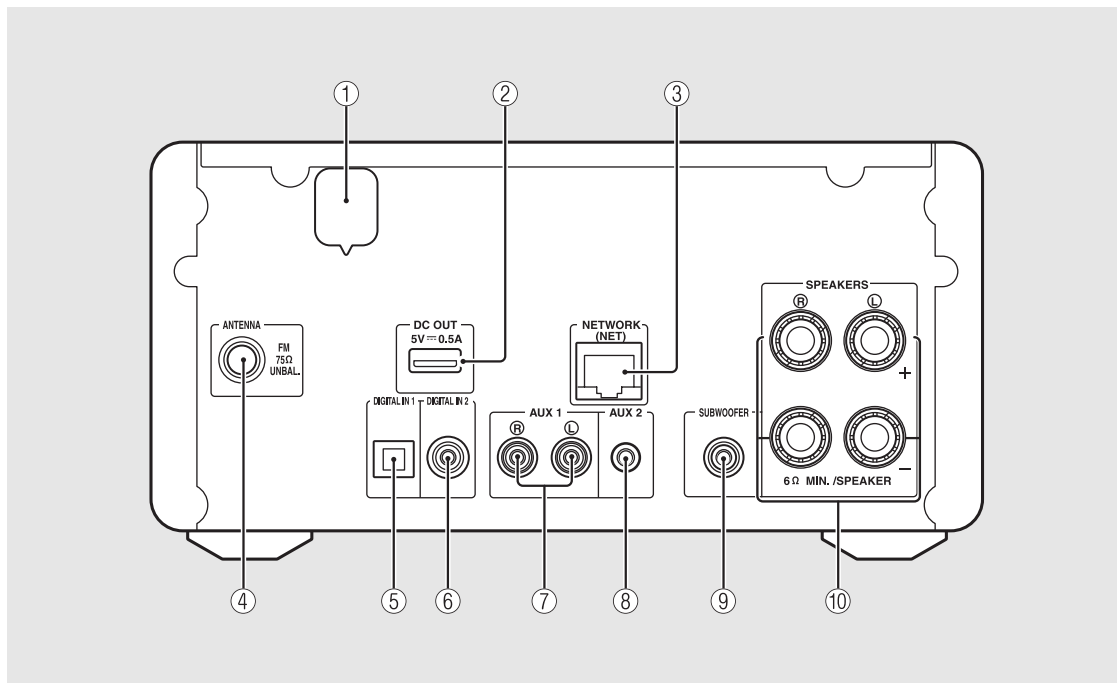

① Power cable (☞ P.12)

② DC OUT terminal

Supplies power to the Yamaha AV accessories from this terminal. When using this, set [Use Accessory] in [System Config] from the option setting, to [YES] (☞ P.31). For details, refer to the owner's manual supplied with the accessory.

③ NETWORK terminal (☞ P.11)

Connects to a network using a commercially available network cable.

④ FM antenna terminal (☞ P.10)

⑤ DIGITAL IN 1 terminal (optical input) (☞ P.19)

⑥ DIGITAL IN 2 terminal (coaxial input) (☞ P.19)

⑦ AUX 1 terminal (RCA input) (☞ P.19)

⑧ AUX 2 terminal (mini jack input) (☞ P.19)

⑨ SUBWOOFER terminal (☞ P.9)

⑩ SPEAKERS terminal (☞ P.9)

Front panel display

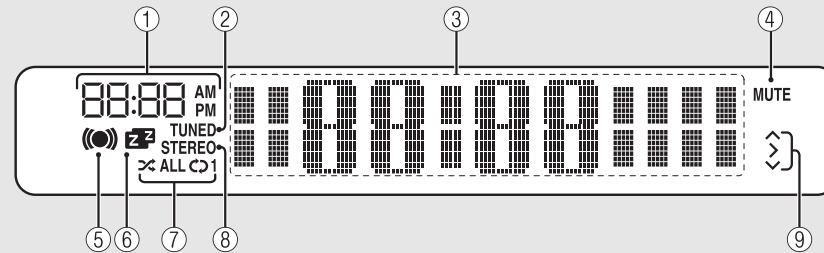

① Clock

Displays the time when the power is on.

② TUNED indicator

Lights up when the unit is tuned into a station.

③ Multi information display

Shows various information, such as the clock in standby mode, music information, or radio frequency (alphanumerics only).

④ MUTE indicator

Lights up when the sound is muted (☞ P.8).

⑤ Wake-up timer indicator

Blinks while setting the wake-up timer and lights up when the timer is set (☞ P.28).

⑥ Sleep timer indicator

Lights up when the sleep timer is set (☞ P.29).

⑦ Shuffle/repeat indicator

Lights up when you set your iPod, CD, USB device, or computer to shuffle or repeat playback (☞ P.20).

⑧ STEREO indicator

Lights up when the unit is receiving a strong signal from an FM stereo broadcast.

⑨ Operation indicators

Shows available control buttons ▲/▼/ENTER (☞ P.8) of the remote control.



Adjusting display brightness

You can adjust the brightness of the front panel display by pressing the **DIMMER** button on the remote control (☞ P.8).

- Each press of the button changes the brightness: bright (default), mid dim, or dim.

Remote control

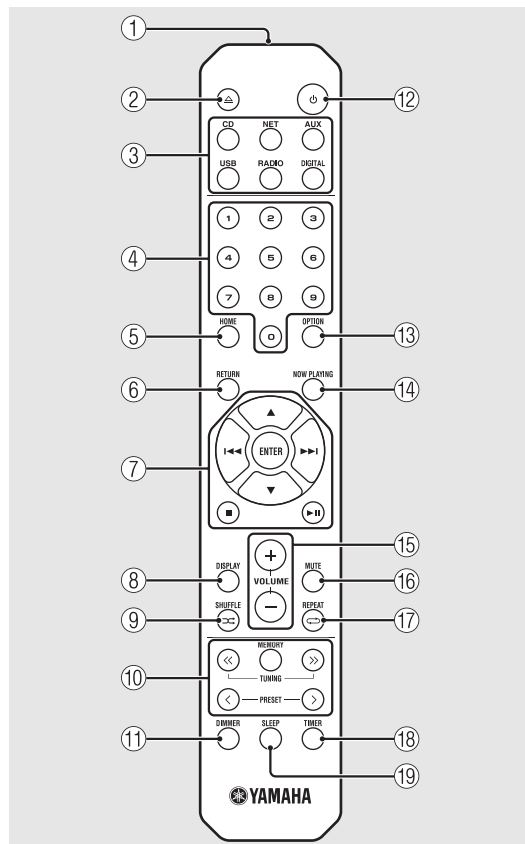

- ① Infrared signal transmitter
- ② (Open/close the disc tray) (☞ P.14)
- ③ Source buttons
Switch the audio source to be played.
- ④ Numeric buttons (☞ P.14)
- ⑤ HOME (☞ P.16, 18, 25)
- ⑥ RETURN (☞ P.14, 16, 18, 25)
- ⑦ Audio control, cursor control buttons
(☞ P.14, 16, 18, 25)
- ⑧ DISPLAY (☞ P.21)
- ⑨ (SHUFFLE) (☞ P.20)
- ⑩ FM control buttons (☞ P.23, 24)
- ⑪ DIMMER (☞ P.7)
- ⑫ (Power) (☞ P.12)
- ⑬ OPTION (☞ P.22, 27, 31)
- ⑭ NOW PLAYING (☞ P.16, 18, 25)
- ⑮ VOLUME +/-
Controls the volume.
- ⑯ MUTE
Turns mute on or off.
- ⑰ (REPEAT) (☞ P.20)
- ⑱ TIMER (☞ P.28)
- ⑲ SLEEP (☞ P.29)

Preparations

Connect speakers or antenna and turn the unit on.

Do not connect the power cable of the unit until you have finished connecting all cables.

Connecting the speakers

- 1 Remove the insulation from the end of the speaker cable to expose the bare wires.

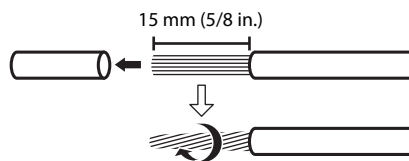

- 2 Connect the speaker to the unit, as the illustration shows.

- Prepare speakers and speaker cables separately.
- For connection of the speakers, refer to the owner's manual supplied with them.

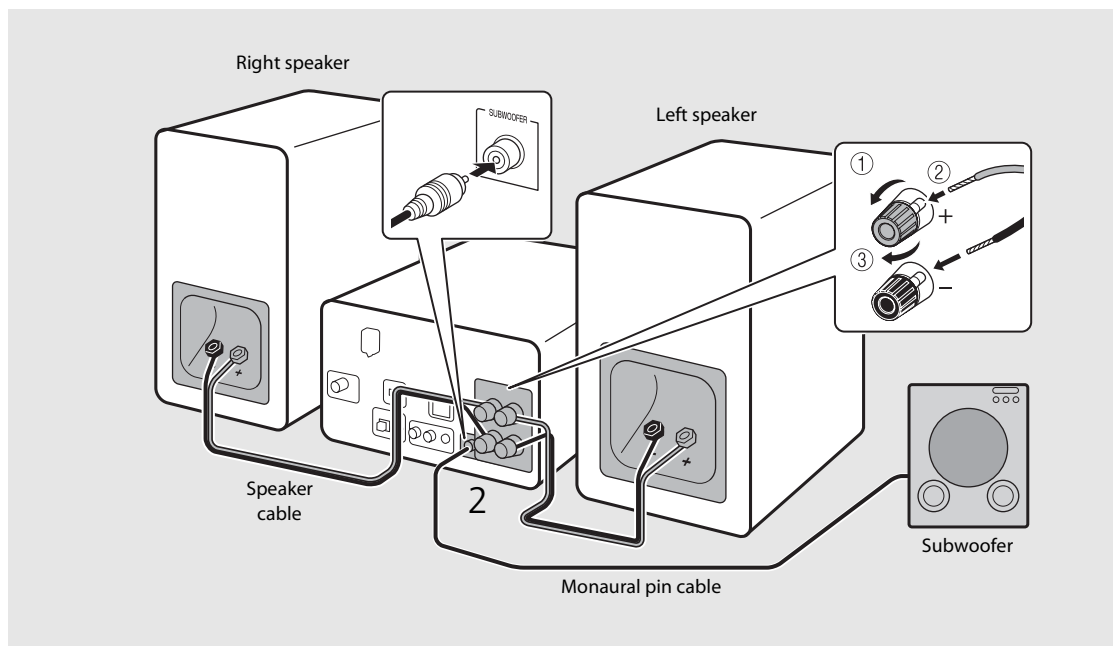

- Take care not to allow the bare speaker wires to touch each other or any metal part of the unit. This could damage the unit and/or the speakers.
- Make sure that left and right (L, R) connections and polarity (red: +, black: -) are correct. If connections are incorrect, the sound will be unnatural.
- Use speakers of at least 6 Ω impedance.
- You can also connect a subwoofer with built-in amplifier to the unit.

Connecting antenna

- 1 Connect the supplied antenna to the unit.
- 2 Install it with pins where the unit can obtain good reception.

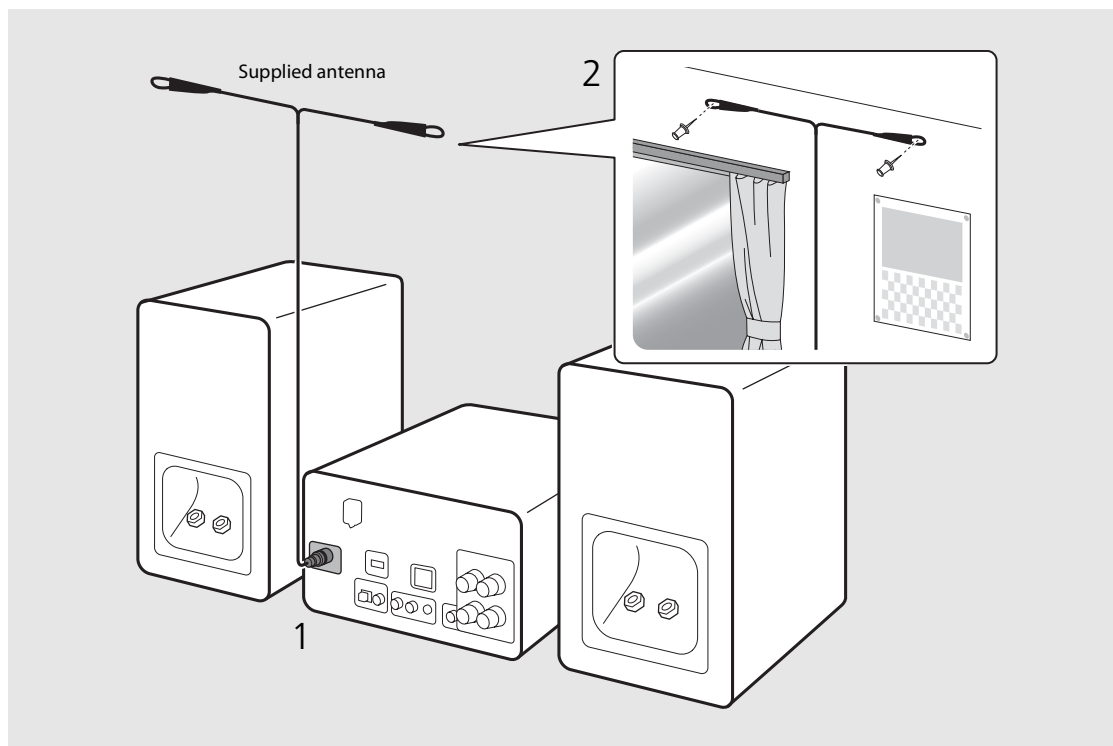

- Be sure to stretch out the antenna as the illustration shows.
- If radio reception with the supplied antenna is not satisfactory, a commercially available outdoor antenna may improve reception.

Connecting to the network

You can play back music files stored on your PC, mobile devices, DLNA*-compatible NAS, or audio contents on the Internet, by connecting this unit to the network. You can also operate the unit with your mobile device.

* Digital Living Network Alliance

Connect the unit to the network as shown on the right.

- Connect with a commercially available STP (shielded twisted pair) network cable (CAT-5 or higher, straight-through cable).

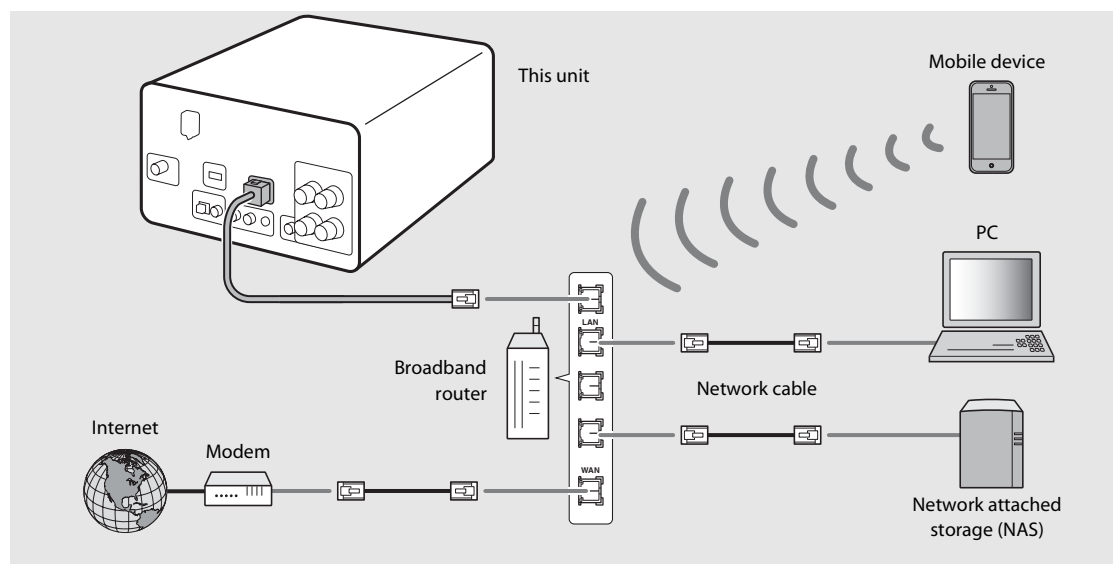





- For details on Internet connection, refer to the owner's manuals of your network devices.
- If you are using a router that supports DHCP, you do not need to configure any network settings for the unit. If you are using a router that does not support DHCP, configure the network setting from [Network Config] in the option setting (P.31).
- Wired connections are recommended for devices other than the mobile to ensure high sound quality.
- Some security software installed on your PC or the firewall settings of network devices (such as a router) may block the access of the unit to the network devices or the Internet. In this case, change the setting of the security software or network devices.
- When setting the subnet manually, each server must be connected to the same subnet as the unit (P.32).

Turning on the power

Plug the power cable into the wall outlet and press .

- The unit turns on.
- Press  again to turn off (standby mode).
- "Eco standby" (default) reduces power consumption of the unit while limiting certain features (as shown in the table on the right).

Canceling the eco standby

- 1 Press  .
 - Option menu is shown on the front panel display.
- 2 Cancel the eco standby.
 - Set the item in the order of [System Config] - [Power Saving] - [Normal].
 - Change the item with / and press  to set.
- 3 Press  to finish the option setting.

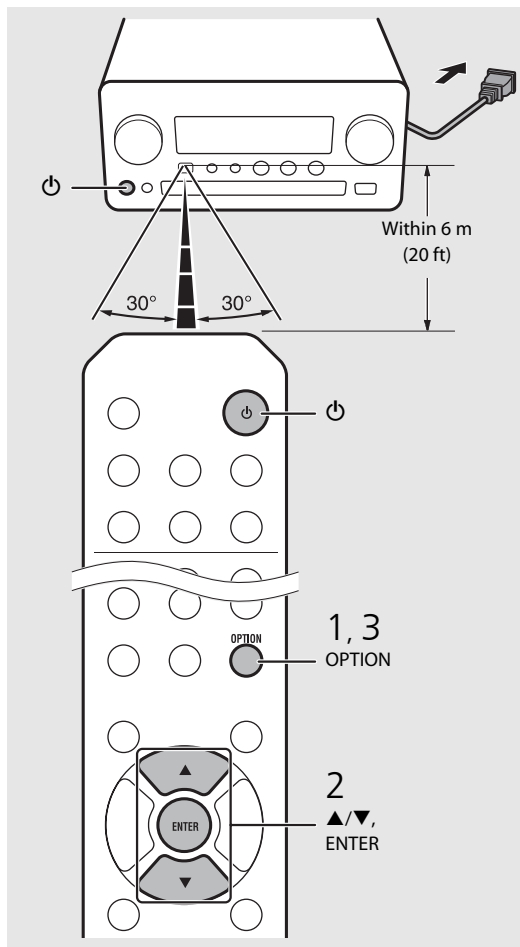

Status in standby/eco standby

	Standby	Eco standby
Charging of iPod/USB devices	✓	—
Enable/disable the wake-up timer*	✓	—
Operation of the source buttons*	✓	✓
CD load/eject	✓	✓
AirPlay	✓	—
Power-on by the application	✓	—
Clock display	✓	—

* Operation with the remote control only

Option menu regarding power (System Config)

(Setting value. **Bold: default**)

Power Saving

Configure the power supply settings.
(Normal, **Eco**)

When you select [Eco], nothing is shown on the front panel display in the eco standby mode.

Auto Power Off

Set the time at which the unit enters standby mode if no operation is performed.

(Timer 2H, Timer 4H, **Timer 8H**, Timer 12H, OFF)

Setting the network devices

Configure your devices connected to the network to play back music files stored on your PC or NAS, or configure your mobile device to control this unit.

PC

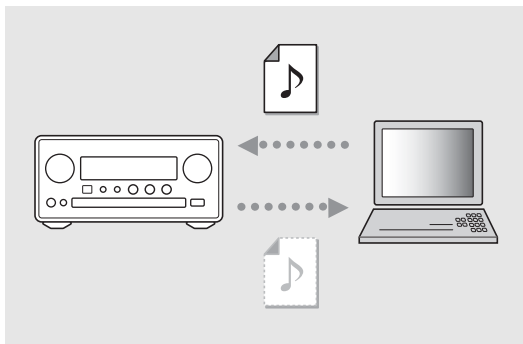

Configure the media sharing setting of your PC (☞ P.17).

NAS

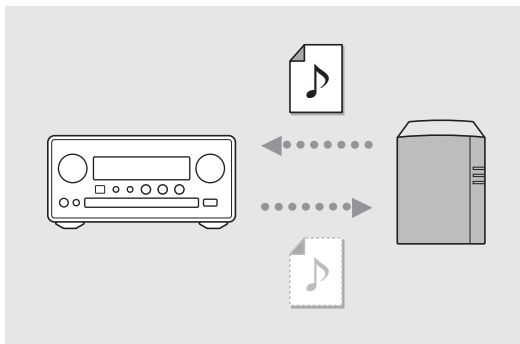

Configure the settings to access your NAS.

- Enable DHCP setting of your NAS if needed.
- For more detailed settings, refer to the owner's manual supplied with your NAS.

Mobile devices

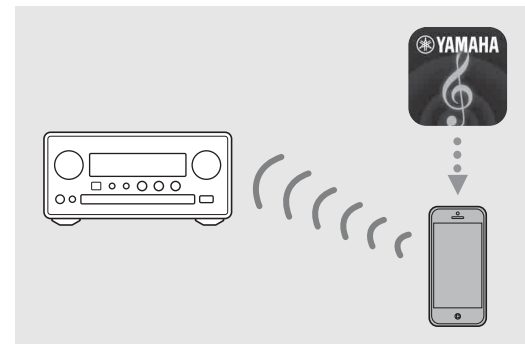

Install the dedicated application "NETWORK PLAYER CONTROLLER" to your mobile devices (☞ P.18).

- The application supports iPhone/iPad/iPod touch and Android mobile devices.
- The mobile device needs to be connected to the same router as the unit.

Listening to CD

This unit allows playback of audio CDs and data CDs in which the MP3/WMA files are recorded. For details on playable CDs, see "Supported devices/medias" (P.39).







1 Turn INPUT to select [CD]. Or, press  on the remote control.

2 Set a CD in a disc tray.

- Press  to open/close the disc tray.

3 Playback starts.

- The remote control functions are shown below.

	Skip to the first file of the previous or next folder when playing back MP3/WMA files.
	Play/pause
	Stop
	Skip to the beginning of the song being played back or the previous song.
	Skip to the next song.
	Starts shuffle playback (P.20).
	Starts repeat playback (P.20).
1 - 9, 0	Specify the song number.
RETURN	Cancel the song number.
ENTER	Apply the song number.

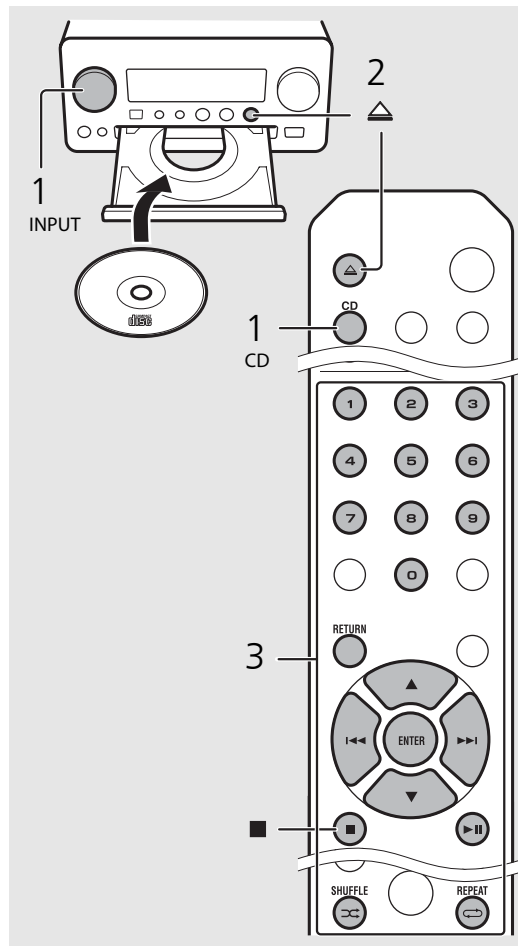

- Files on a data CD are played back in alphanumeric order.
- When CD playback is stopped, playback will resume from the beginning of the song last played. Pressing  while playback is stopped will clear resume playback.

Listening to iPod/USB devices

This unit allows playback of iPod or USB devices which music files are recorded.
For details on playable iPod/USB devices, see "Supported devices/media and file formats" (P.39).

▶ Playing iPod

- 1 Turn INPUT to select [USB] or press  on the remote control.
- 2 Connect the iPod to the USB jack.
 - Prepare the USB cable supplied with your iPod.
 - The source changes to [iPod].
- 3 Playback starts (☞ P.16).

▶ Playing USB devices

- 1 Turn INPUT to select [USB]. Or, press  on the remote control.
- 2 Connect a USB device to the USB port.
- 3 Playback starts (☞ P.16).

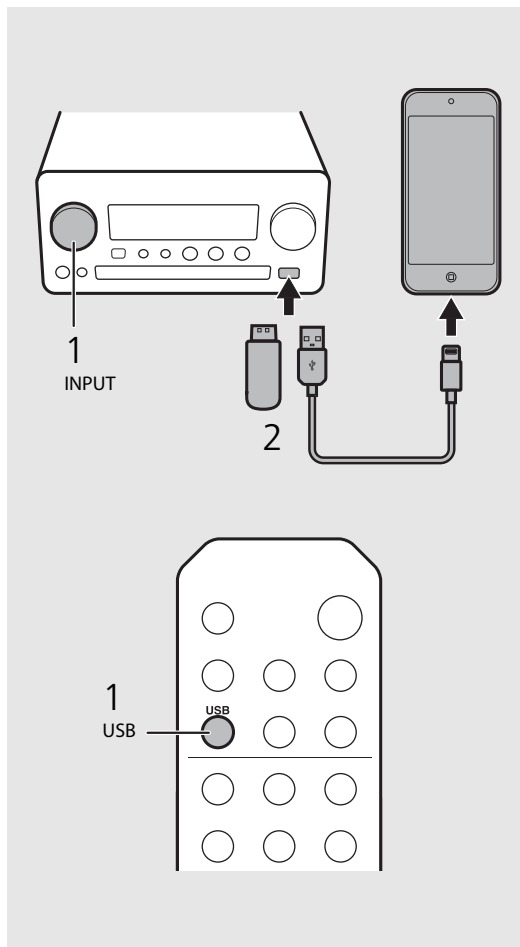







- Some iPods/USB devices may not work properly even if they meet the requirements. Playability of and power supply to all iPods/USB devices are not guaranteed.
- Yamaha and suppliers do not accept any liability for the loss of data saved on an iPod or a USB device connected to the unit. As a precaution, it is recommended to make backup copies of important files.



- Stop playback before disconnecting the USB device.
- An iPod or USB device is automatically charged when it is connected to the unit, except in the eco standby mode.

Remote control operation for iPods/USB devices

	Skip to the beginning of the song being played back or previous song (for iPod, press and hold to fast rewind).
	Skip to the next song (for iPod, press and hold to fast forward).
	Stop
	Play/pause
	Shuffle playback (☞ P.20)
	Repeat playback (☞ P.20)

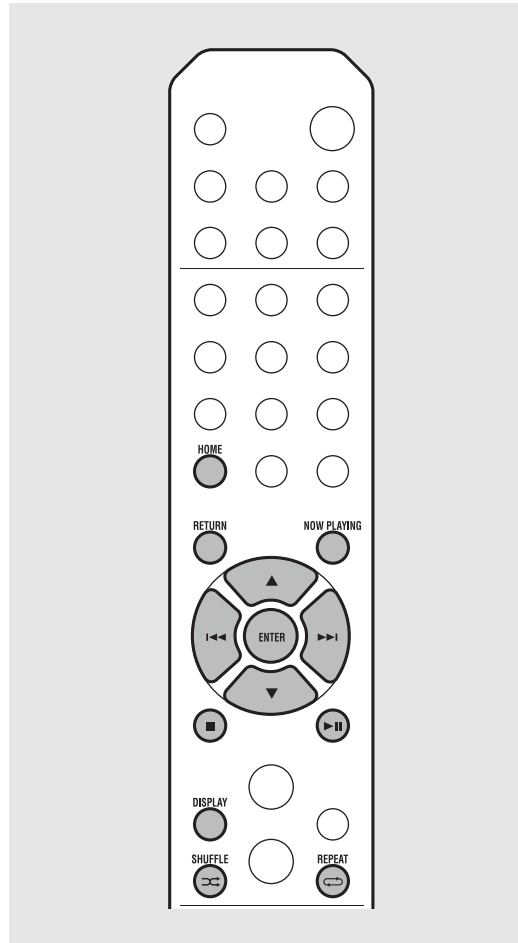

Switching the information display of iPod

- When operating your iPod with Yamaha's application "NETWORK PLAYER CONTROLLER," the information display switches to the extended mode.

To switch the information display mode, press and hold the **DISPLAY** button.

- **Standard mode** (default): Operate your iPod while viewing the screen of the iPod and select a song to play back.
- **Extended mode**: Operate the remote control while viewing the iPod information shown on the front panel display (browsing operation) and select a song to play back. The remote control functions are as shown below.

	Show other item.
ENTER	Confirm the selected item and proceed to the next level or start playback.
HOME	Show the top-level item.
RETURN	Back to the previous item.
NOW PLAYING	Finish browsing and display the playback content information.

Listening to the songs in the computer

This unit allows you to play back music files such as MP3, WMA, or FLAC (lossless audio data compression format) files stored in the computer (server) connected to the network or NAS. Brows the front panel display and select your favorite music file.

Setting the media sharing of music files

To play back music files in your computer with this unit, you need to make the media sharing setting between the unit and computer (Windows Media Player 11 or later). In here, setting with Windows Media Player 12 in Windows 7 is taken as an example.

- 1 Start Windows Media Player 12 on your PC.
- 2 Select "Stream", then "Turn on media streaming."
 - The control panel window of your PC is shown.
- 3 Click "Turn on media streaming."
- 4 Select "Allowed" from the drop-down list next to "CRX-N560."
- 5 Click "OK" to exit.

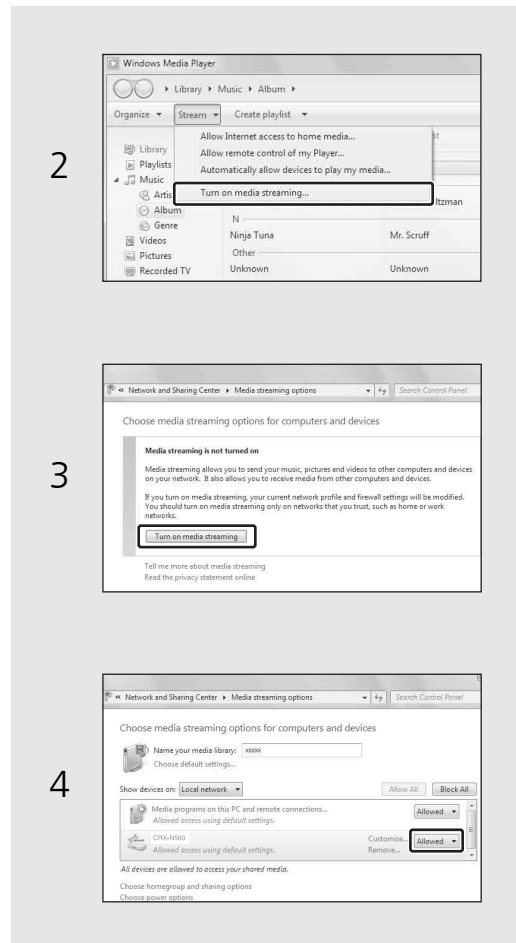

- For details on media sharing settings, refer to Windows Media Player help.

For Windows Media Player 11

- 1 Start the Windows Media Player 11 on your PC.
- 2 Select "Library" then "Media Sharing."
- 3 Check the "Share my media to" box, select the "CRX-N560" icon, and click "Allow."
- 4 Click "OK" to exit.

For a PC or a NAS with other DLNA server software installed

Refer to the owner's manual of your device or software and configure the media sharing settings.

▶ Playing back songs in the PC

1 Press **NET** repeatedly and select [Server].

2 Browse and select a song.

▲/▼	Show other item.
ENTER	Confirm the selected item and proceed to the next level or start playback.
HOME	Show the top-level item.
RETURN	Back to the previous item.
NOW PLAYING	Finish browsing and display playback content information.

3 Start playback.

▶	Play/pause
▶▶/◀◀	Move to the next or previous song in the folder.
■	Stop
⌘	Shuffle playback (☞ P.20)
↺	Repeat playback (☞ P.20)

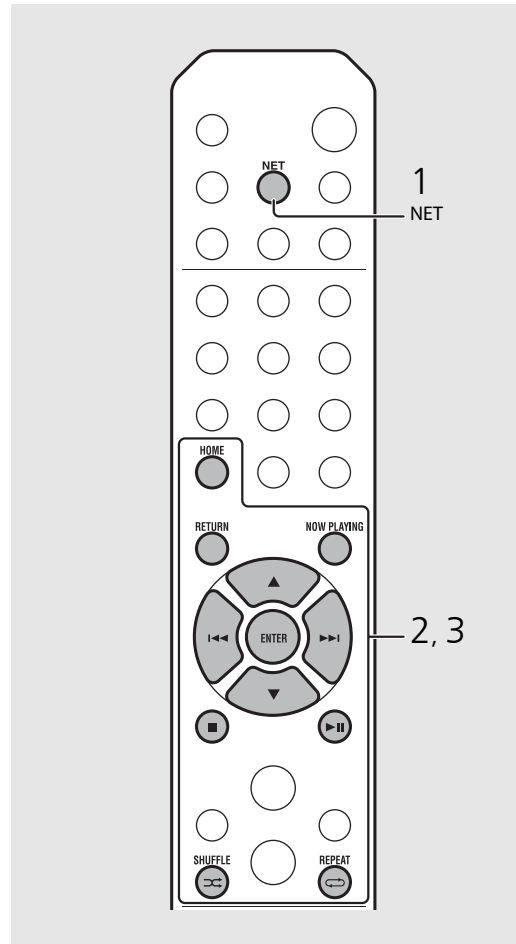

- If playback is not possible, make sure this unit and the PC (server) are connected to the same router (☞ P.11).

Operating from your mobile device

Once you install the app “NETWORK PLAYER CONTROLLER” in your mobile device, you can operate the unit with the mobile device.

- Features
 - Power-on/off, adjusting volume or other basic operation
 - Changing the music source
 - Displaying the information of the radio tuner
 - Selecting, playing back, and stopping songs
 - Playing back songs stored in devices

For downloading the app or the latest information, access to the App Store or Google Play and search “NETWORK PLAYER CONTROLLER.”

Listening to external sources





This unit allows playback of external devices, such as a DVD player or mobile music player. Use the terminal (DIGITAL IN 1/2 or AUX 1/2) according to the device to be connected (☞ P.6). For the connection of each external device, refer to its supplied owner's manual.

1 Unplug the power cable of the unit and connect the external device to the unit.

- Prepare commercially available cables for connection.

2 Plug the power cable of the unit back into the wall outlet and press  to turn the unit on.

3 Change the music source.

- Press  or  according to the connecting terminal for the external device you wish to play back.
- Press  to change the source to AUX1/AUX2 (analog input), press  to change the source to DIGITAL IN1/DIGITAL IN2 (digital input).

4 Play back the connected external device.

- For details on playback, refer to the owner's manual supplied with the external device.

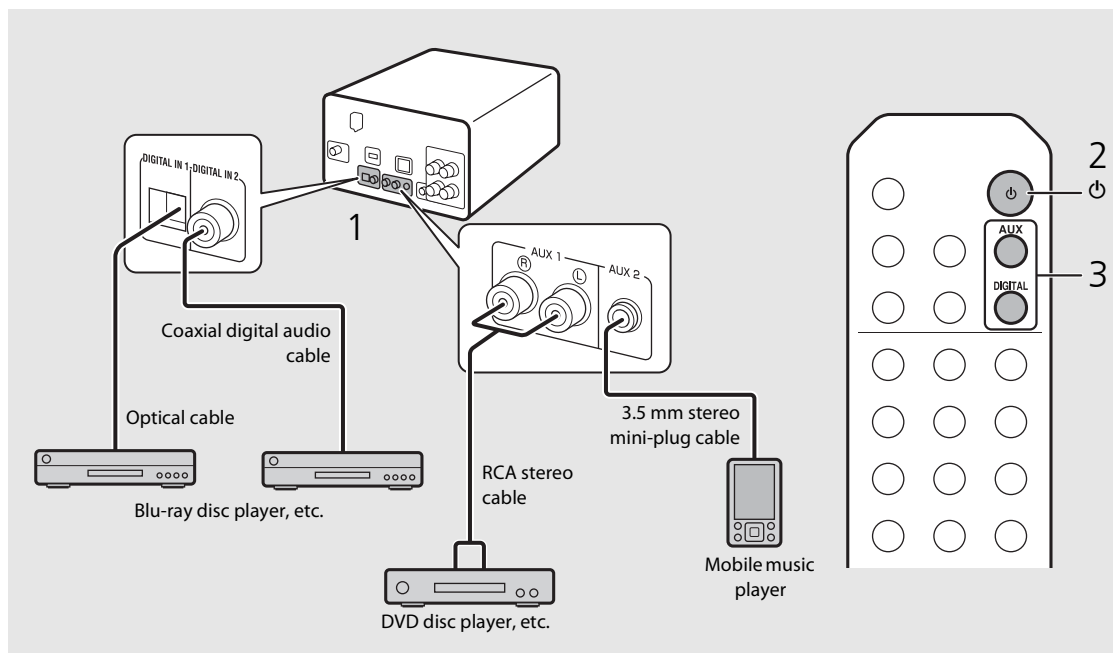

- **Decrease the volume of the unit and the external device before connection.** Otherwise, playback volume may be too loud.

More on playback

You can enjoy music in varied song order or sound quality, and view music information during playback. Operations described in this section apply to all devices, such as PC (server), iPod, USB device, or CD.

Shuffle playback

Press  during playback.

- The shuffle indicator in the front panel display switches as shown below each time you press the button.



 ALL	Perform shuffle playback.*
Not displayed	Does not perform shuffle playback.

* The range of shuffle depends on the media being played back.

Repeat playback

Press  during playback.

- The repeat indicator in the front panel display switches as shown below each time you press the button.

 1	Repeat the song being played back.
ALL 	Perform repeat playback.*
Not displayed	Does not perform repeat playback.

* The range of repeat depends on the playback media.

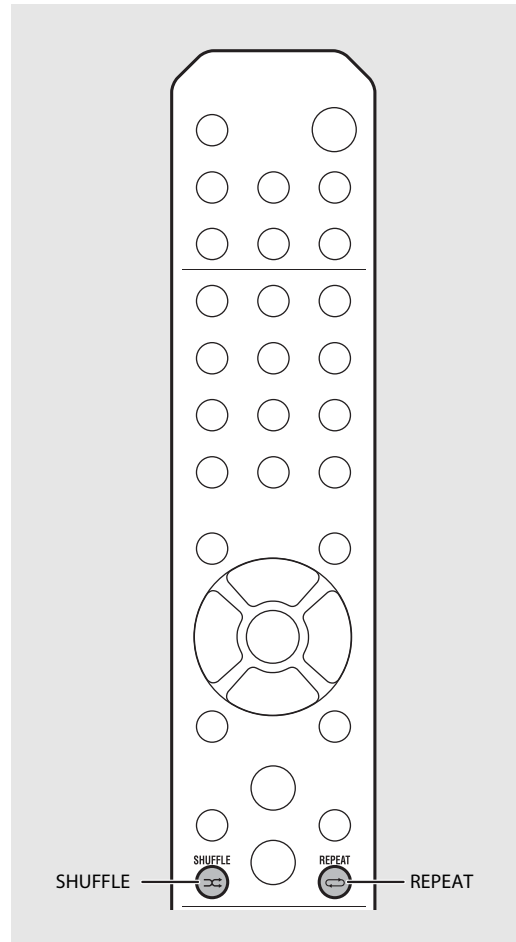

- Shuffle playback and repeat playback can be performed at the same time (except  1).

Playback information

Song title, elapsed time, etc., can be shown on the front panel display.

Press  during playback.



- Display switches in the order as shown below each time you press .

USB/iPod/AirPlay/Server	CD
Song title* ¹	Playing time
Album tile	Remaining time of the song* ²
Artist name	Remaining time of the disc* ²
Playing time	Song title* ^{1, 3}
	Album tile* ³
	Artist name* ³

*1 If the song title cannot be obtained, the file title may be displayed.

*2 Only when playing an audio CD.



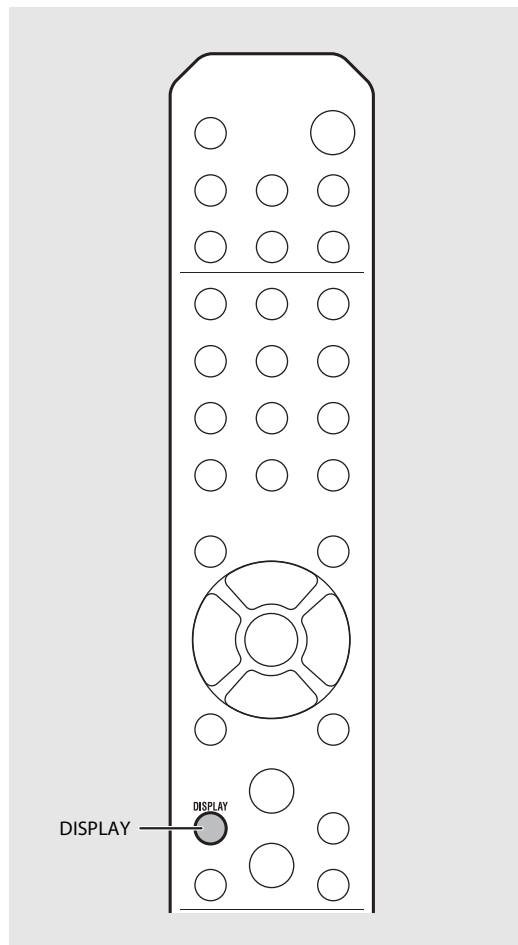





*3 Only when playing an audio CD and when there is information to display.



- Characters shown on the front panel display are alphanumerics only.
- Information is not displayed when the iPod display mode is the standard mode (ⓘ P.16).

Adjusting sound quality

Use the option setting to adjust sound quality.

- 1 Press .
 - Option menu is shown on the front panel display.
- 2 Press  to select the desired item and press .
- 3 Press  to change the setting and press .
 - The setting is applied.
 - Press  to return to the previous item.
 - To cancel the sound quality setting, press .
 - To set other items, repeat steps 2 and 3.
- 4 Press  to finish the option setting.

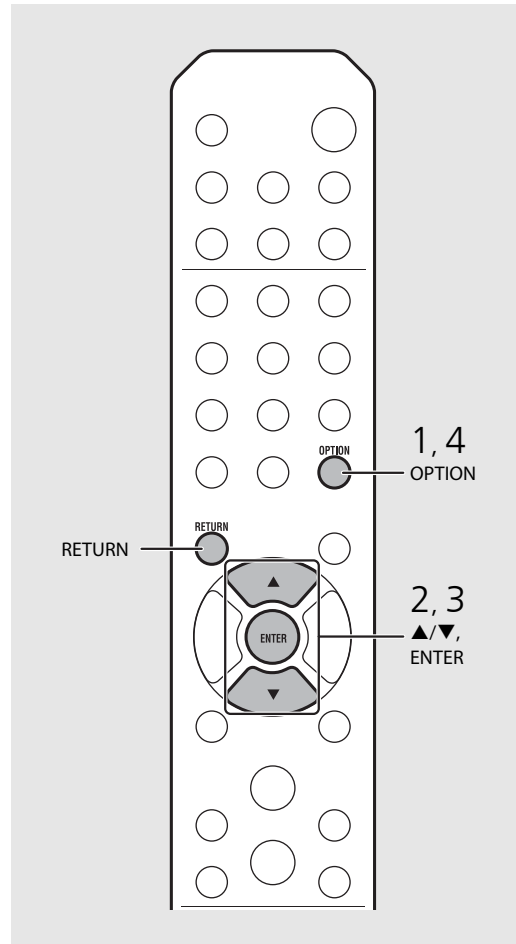

Option menu regarding sound quality

(Setting value. **Bold: default**)

Equalizer

Adjusts low frequency [EQ Low], middle frequency [EQ Mid], and high frequency [EQ High]. The setting is also applied when using headphones.
(-10 to **0** to +10)

Balance

Adjusts the volume balance of the left and right speakers. This setting is not applied when using headphones.
(Lch. +10 to **-CENTER-** to Rch. +10)

Music Enhancer

Regenerates musical elements that are lost through compression.
(ON, **OFF**)
When playing back a high quality music source, such as FLAC or WAV, it is recommended to set to [OFF]. When playing back an audio CD that has not been compressed, this function is not available even if [ON] is set.

Listening to FM radio stations

To listen to FM radio stations, connect the supplied antenna.
See "Connecting antenna" (P.10) for connecting the antenna to the unit.

Tuning in FM stations

- 1 Press **RADIO**.
 - 2 Press and hold **TUNING** (◀) / (▶).
- Automatic tuning starts, then stops automatically when a station is tuned in.

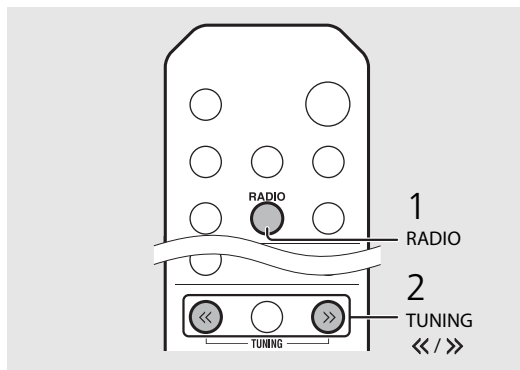

- If station reception is weak, you can tune into a station manually by pressing the **TUNING** ◀ / ▶ button repeatedly.

Presetting FM stations

Auto preset

Tunes in stations with good reception and presets them automatically.

- 1 Press **RADIO**.
 - 2 Press and hold **MEMORY** for 2 seconds or more.
 - 3 Press **MEMORY**.
- Auto preset starts and when it finishes, "Completed!" is shown on the front panel display.

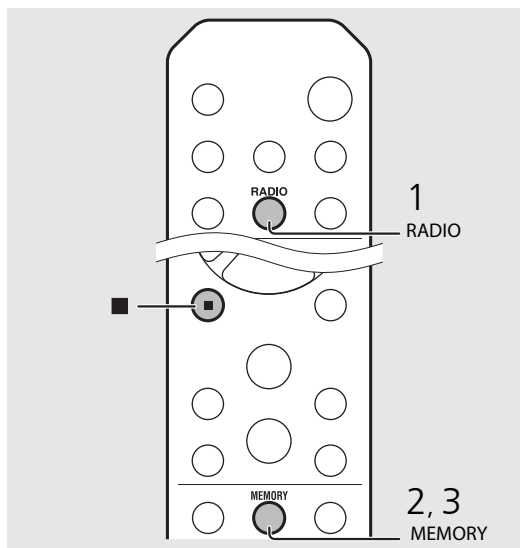

- Auto preset replaces all currently-stored stations with newly-stored stations.



- You can preset up to 30 FM stations.
- To cancel the auto preset, press ■.

Manual preset

- 1 Tune into a station you want to store (☞ P.23).
- 2 Press **MEMORY**.
 - Preset number flashes on the front panel display.



- 3 Press **▲/▼** to select the desired preset number.
- 4 Press **ENTER** to preset the station.

Selecting preset FM stations

- 1 Press **RADIO**.
- 2 Press **PRESET </>** to select a station.

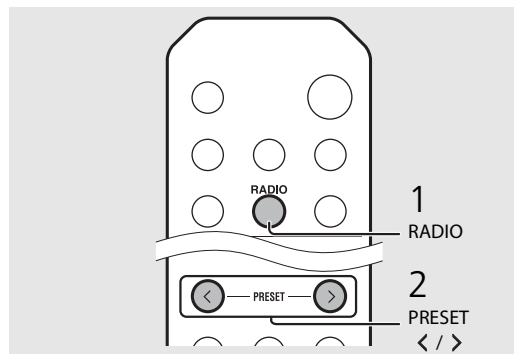
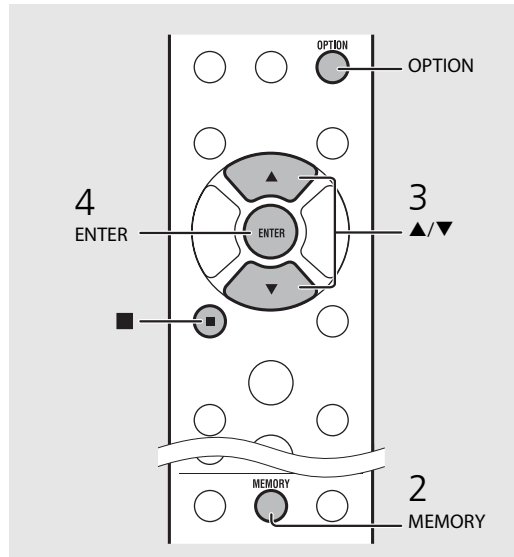

- To cancel manual preset setting, press **■**.

Deleting a preset station

Use the option setting to delete a preset station.

- 1 Press **OPTION** when the source is FM.
 - Option menu is shown on the front panel display.
 - To cancel deleting preset stations, press **OPTION**.
- 2 Press **▲/▼** to select [Preset Delete] and press **ENTER**.
- 3 Press **▲/▼** to select the preset number to be deleted.
- 4 Press **ENTER**.
 - The preset station is deleted and [Deleted!] is shown on the front panel display.
- 5 Press **OPTION** to finish the option setting.

Listening to Internet radio

You can listen to world-wide radio stations via Internet.
Make sure that the unit is connected to the Internet properly (☞ P.11).

1 Press  repeatedly to select [Net Radio].

2 Browse the Internet and select a radio station.



- The remote control functions are shown below.

	Shows other item.
ENTER	Confirm the selected item and proceed to the next level or start playback.
HOME	Show the top-level item.
RETURN	Back to the previous item.
NOW PLAYING	Finish browsing and display the playback content information.

3 Playback starts.

- To stop playback, press .

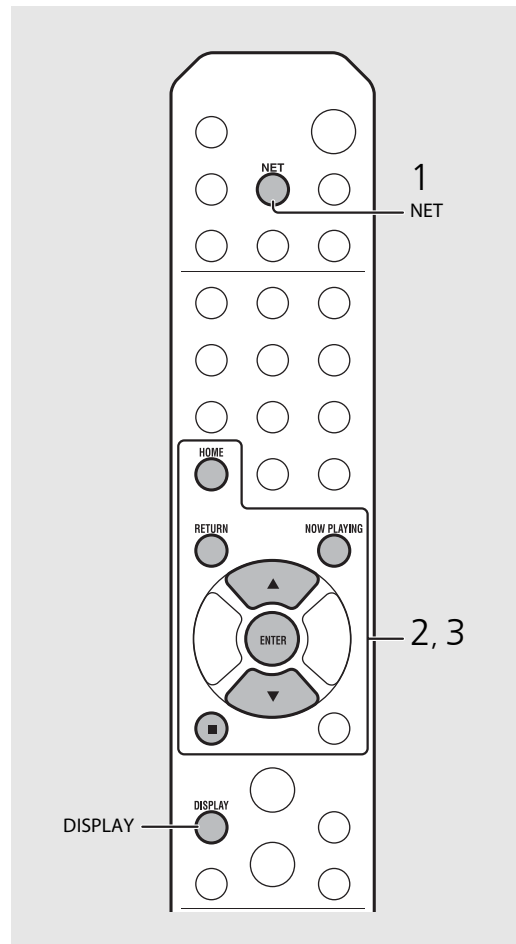

- Playback information can be shown by pressing the **DISPLAY** button while Internet radio is played back. Information changes as shown below each time you press it.



Radio station name (default)
Song title
Playing time

- You can register your favorite Internet radio stations to the "Bookmarks" folder by selecting [Net Radio] as the source on the unit and then accessing the following website with the web browser on your PC.
<http://yradio.vtuner.com/>
To use this feature, you need the vTuner ID of the unit and your e-mail address to create your personal account. You can check the vTuner ID (MAC address of the unit) in [Network Info] (☞ P.32) in the option setting.

Listening to the Music with AirPlay

The AirPlay function allows you to play back iTunes/iPod music on the unit wirelessly via a network. Make sure that the unit and your PC or iPod are connected to the same router (P.11).

▶ Playing iPod

- 1 Turn on the unit and display the playback screen on the iPod.
 - If the iPod recognizes the unit,  is shown on the screen of the iPod.
- 2 Tap  and select the unit's name.
 - The source automatically switches to [AirPlay] and playback starts (except in the eco standby mode).





- When you use iTunes/iPod controls to adjust volume, the volume may be unexpectedly loud. This could result in damage to the unit or speakers. If the volume increases during playback, stop playback on iPod/iTunes immediately.



- You can also use the unit and remote control to play back, pause, stop, and skip songs.
- To control iTunes playback with the remote control, you need to configure the iTunes preferences to enable iTunes control from remote speakers in advance.

▶ Playing iTunes

- 1 Turn on the unit and start iTunes.
 - If the iTunes recognizes the unit,  is shown on the screen of iTunes.
- 2 Click  and select the unit's name.
 - The source automatically switches to [AirPlay] (except in the eco standby mode).
- 3 Play back songs with iTunes.

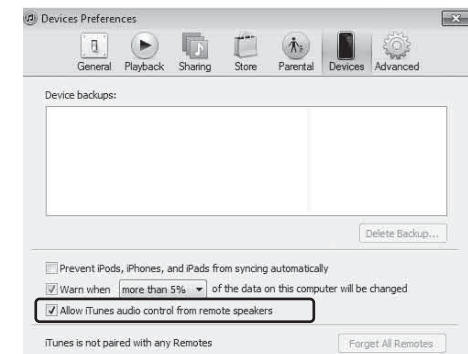
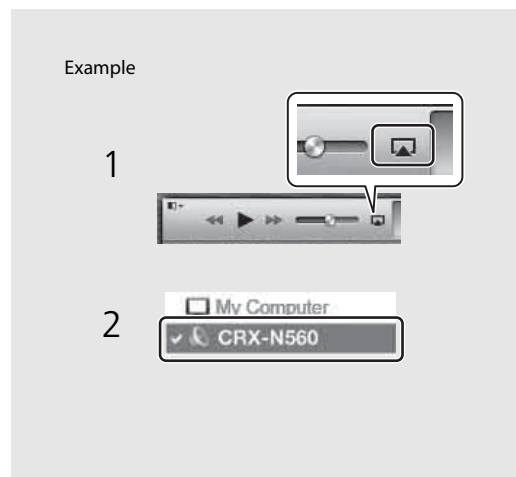

Clearing AirPlay

- Tap/click  on the iPod/iTunes screen and select a device other than CRX-N560 from the speaker list. Or, change the source to other than AirPlay.

Using the clock

Once you set the clock, you can play your favorite song or radio program as an alarm.

Setting the clock

- 1 Press **OPTION**.
 - Option menu is shown on the front panel display.
- 2 Select [System Config] with **▲/▼** and press **ENTER**.
- 3 Select [Clock Setting] with **▲/▼** and press **ENTER**.



- 4 Set the date and time.
 - Change the setting with **▲/▼** and press **ENTER** to confirm it.
 - Perform the procedure in the order of year, month, day, hour, and minute.
 - To cancel the setting, press **RETURN**.
 - When the setting completes, [Completed!] is shown.
- 5 Press **OPTION** to finish the option setting.

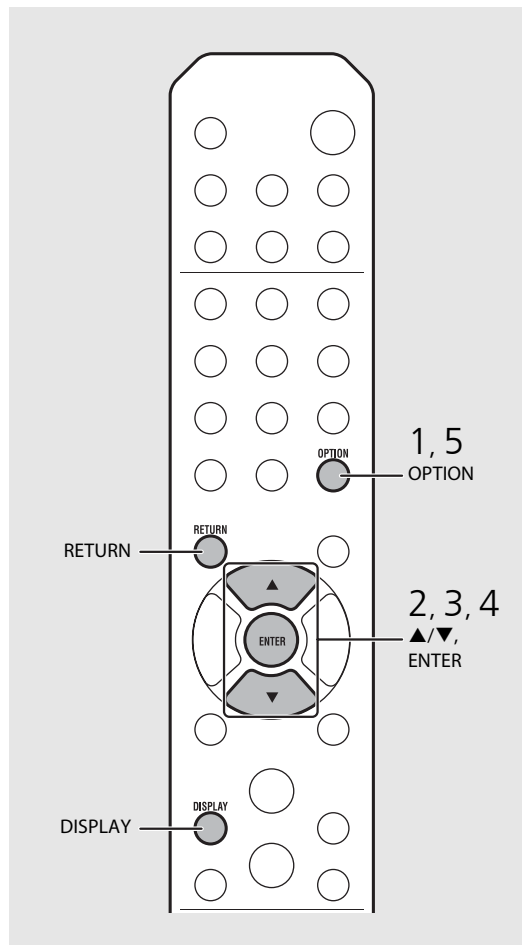

- The clock setting will be lost if you disconnect the power cable from the wall outlet for about a week. Set the clock again.



- The clock format (12-hour/24-hour) can be changed if you press the **DISPLAY** button while setting the clock.

Setting the wake-up timer



Music or beep will be started at the time you set.

1 Press and hold .

- [Timer Setting] and time are shown on the front panel display, and  and hour flash.



2 Set the following items, ① to ③.

- Press  to select a setting value and press  to set the item.
- The display switches to the next item.
- To cancel the setting, press .

① Start-up time

Set the hour and minute.

② Volume

Can be set between [5] to [59], and [MAX].





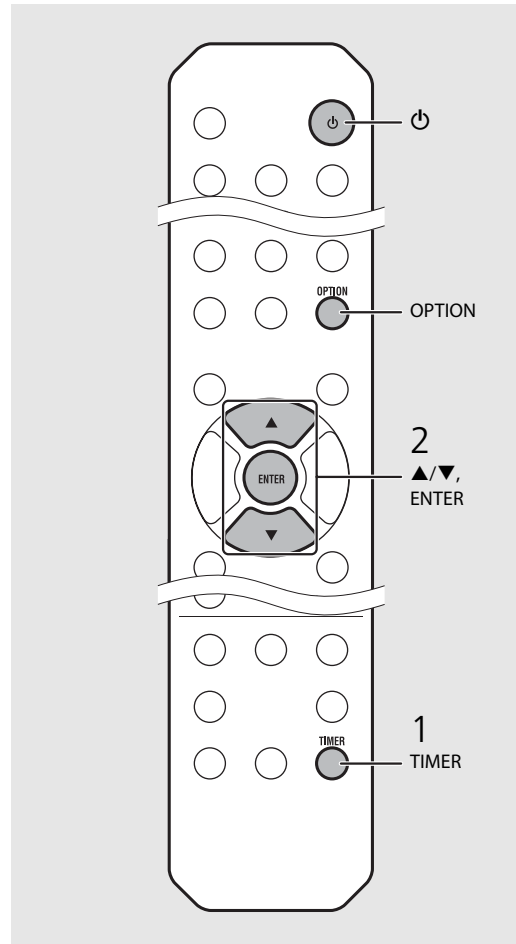

③ Repeat

Repeat: Wake-up timer sounds everyday at the set time.

No Repeat: Wake-up timer sounds once.

Continue to the next page ➔



- Set the clock before setting the wake-up timer.
 - Wake-up timer is not available when [Power saving] is set to [Eco]. Set it to [Normal] (☞ P.12).
-  You can also set the wake-up timer using the option setting.
- 1 Press .
 - The setting menu is shown on the front panel display.
 - 2 Press  to select [Timer Setting] and press .
 - 3 Perform step 2 on the left.
 - 4 Press  to finish the option setting.
 - 5 Set the music source, play back the source, and press .

- When the setting completes, [Completed!] is shown and  lights up on the front panel display.





3 Press .

- The unit enters the standby mode and the beep sounds at the time you set.
- If you wish to play back music at the time you set, select an audio source and play it back before pressing  in this step. See (*) at the bottom of tips on the right for details on audio source playback.



Sleep timer

You can set the time to elapse which the unit automatically enters to standby mode.

Press  several times to select the time.

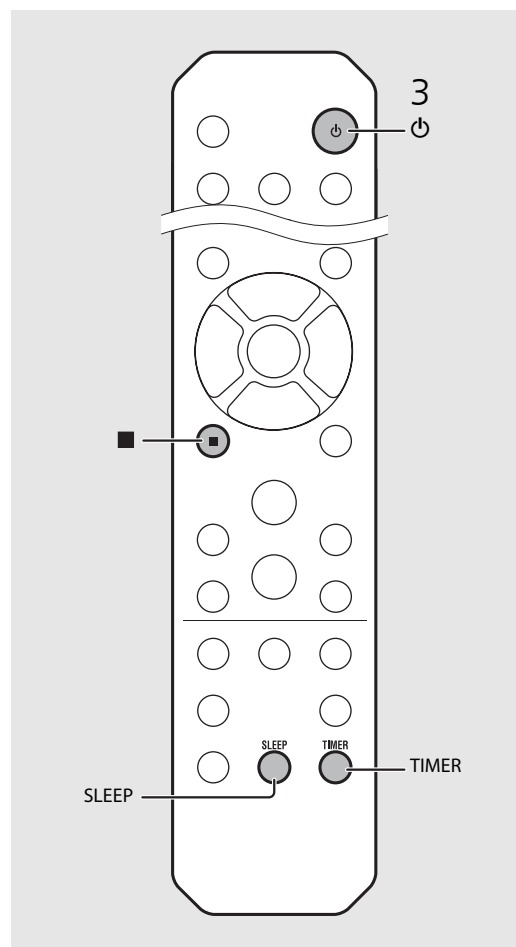
- Time can be selected from 30/60/90/120 min., or OFF.
-  lights up shortly after the time is selected, and the sleep timer is set.
- To cancel the sleep timer, press  again.



- If the source is removed from the unit after the wake-up timer is set, the unit will beep at the start-up time.
 - If any music source is played back at the start-up time,  flashes and playback will continue.
 - After setting the wake-up timer, you can enable or disable it by pressing the **TIMER** button when the unit is on.
 - To stop the beep, press  or ; otherwise, it will stop after 60 minutes.
- * When the music source is set to AUX, Server, DIGITAL IN, or AirPlay, the unit beeps at the start-up time.

Updating the firmware

When new firmware is released, a message to update your current firmware will be shown on the front panel display (when the unit is connected to the Internet only). In this page, an updating method via a network using the option setting is shown.

1 Press .

- The option menu is shown on the front panel display.

2 Select [System Config] with ▲/▼ and press .

3 Select [Firm Update] with ▲/▼ and press .

4 Select [Network] with ▲/▼ and press .

- Update starts.



- When update finishes, messages are shown in the following order: "Update success.", "Please...", and "power off!"

5 Unplug the power cable from the wall outlet and plug it back after about 30 seconds.

- Update is applied.

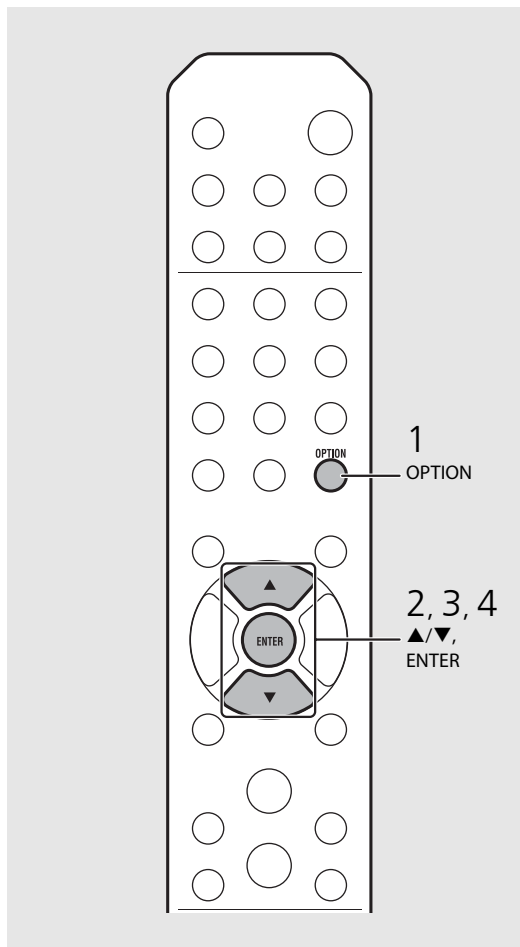

- Do not operate the unit or disconnect the power cable and network cables while updating.



- Once the message prompting update is shown on the front panel display, it will not be shown again, even if you do not perform updating. However, when you turn on the unit after the power cable has been disconnected from the wall outlet for a while, the message will be shown.
- When Internet speed is not fast enough or the unit is connected to the wireless network via a wireless network adapter, network update may not be possible depending on the condition of the wireless connection. In this case, try again or update the firmware using a USB memory device. The firmware can be downloaded from the Yamaha Website.

To update the firmware using a USB memory device

You can download the firmware to the USB memory device, and connect that USB memory device to the USB jack on the unit.

- Select [USB] in step 4 and press the **ENTER** button to start the update.

Option settings

Option settings allow you to configure the unit to suit how you will use it.

1 Press .

- Option menu is shown on the front panel display (☞ P.32).

2 Select a desired option menu with ▲/▼ and press .



3 Change the setting with ▲/▼ and press .

- Repeat step 3 if the sub menu is required to be set.
- Press  to cancel the setting and return to the previous level.
- Repeat steps 2 and 3 if you set another menu item.

4 Press  to finish the option setting.

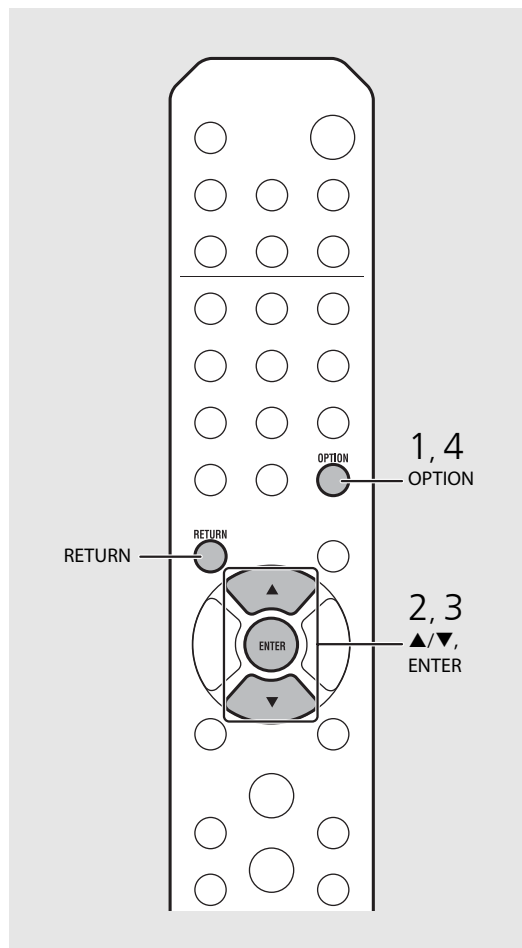

- To set [Advanced Setup] in the option menu, press the **OPTION** button on the remote control while pressing and holding  (stop button) of the unit, then proceed to step 3.

Option menu list

Menu	Sub menu	Default	Function
Preset Delete* ¹ (☞ P.24)			Deletes preset stations.
Equalizer (☞ P.22)	EQ Low	0	Adjusts low frequency.
	EQ Mid	0	Adjusts middle frequency.
	EQ High	0	Adjusts high frequency.
Balance (☞ P.22)		CENTER	Adjusts the volume balance of the left and right speakers.
Music Enhancer (☞ P.22)		OFF	Enables/disables Music Enhancer.
Timer Setting (☞ P.28)			Sets the wake-up timer.
Network Info	Network Status		Shows connection status of the unit and network.
	MAC Address		Shows MAC address.
	System ID		Shows the system ID.
	Network Name		Shows the name of the unit that appears on the network.

Menu	Sub menu	Default	Function
Network Config	DHCP Enabled	YES	Enables/disables DHCP.
	IP Address	0.0.0.0	Confirms and sets the IP address.
	Subnet Mask	0.0.0.0	Confirms and sets the subnet mask.
	Def. Gateway	0.0.0.0	Confirms and sets the default gateway.
	DNS Server(P)	0.0.0.0	Confirms and sets the primary DNS server.
	DNS Server(S)	0.0.0.0	Confirms and sets the secondary DNS server.
System Config	Clock Setting		Sets clock of this unit (☞ P.27).
	Power Saving	Eco	Sets the eco standby (☞ P.12).
	Auto Power Off	Timer 8H	Sets the unit into standby mode automatically (☞ P.12).
	Use Accessory	NO	Selects whether or not to supply power to a Yamaha accessory connected through the DC OUT jack.
	Firm Version		Shows the firmware version of the unit.
	Firm Update	Network	Updates the firmware of the unit (☞ P.30).

Advanced Setup (☞ P.31)	MAC Add.Filter	OFF	Specifies the MAC address (up to 5) and restricts access to this unit of network components. (Operation with AirPlay is not affected even if [MAC Add.Filter] is set to [ON].)
	Factory Reset		Resets the unit's settings to factory default.

*1 Only when the radio is played back

Troubleshooting

Refer to the table below when the unit does not function properly. If your problem is not listed below or if the instruction below does not help, turn off the unit, disconnect the power cable, and contact the nearest authorized Yamaha dealer or service center.

First, check that the connectors of each cable are securely inserted in to jacks on each device.

General

Problem	Cause	Solution
The unit enters the standby mode soon after the power is turned on. The unit does not operate properly.	The power cable is not properly connected.	Connect the power cable firmly.
The power does not turn off.	The internal microcomputer has frozen, due to an external electric shock (such as lightning or excessive static electricity) or to a drop in the power supply voltage.	Hold down ⏻ on the front panel for more than 10 seconds to initialize and reboot the unit. (If the problem persists, unplug the power cable from the wall outlet and plug it again after 30 seconds or more.)
No sound.	No appropriate source has been selected.	Select an appropriate source with INPUT on the front panel or the source buttons on the remote control (☞ P.5, 8).
	Speaker connections are not secure.	Secure the connections (☞ P.9).
	The volume is minimum or mute.	Turn up the volume.
The power is suddenly turned off.	The sleep timer may be set (☞ P.29). Auto Power Off is set (☞ P.12).	Turn on the unit and play the source again.
The clock setting has been cleared.	The power cable has been disconnected or there was power outage.	Connect the power cable, and set the clock again (☞ P.27).
Sound is heard from the speaker on one side only.	Source device or speakers are not connected properly.	Connect the source device or speaker cables properly (☞ P.9, 19). If the problem persists, the cables may be defective.
There is noise interference from digital or high-frequency equipment.	This unit is too close to the digital or high-frequency equipment.	Place this unit farther away from such equipment.
The remote control does not work or does not function properly.	The remote control may be operated outside its operation range.	Operate the remote control within its operation range (☞ P.12).
	The remote control sensor on this unit may be exposed to direct sunlight or strong lighting such as an inverter type fluorescent lamp.	Change the orientation of lighting or the unit, or location of the unit.
	The battery may be worn out.	Replace the batteries with new ones (☞ P.4).
	There are obstacles between the sensor of this unit and the remote control.	Remove the obstacles.

Network

Problem	Cause	Solution
The network feature does not function.	The network parameters (IP address) have not been obtained properly.	Enable the DHCP server function on your router and set [DHCP Enabled] of [Network Config] in the option menu to [YES] on the unit. If you want to configure the network parameters manually, check that you are using an IP address which is not used by other network devices in your network (☞ P.32).
Playback stops (songs cannot be played back continuously).	There are unsupported files in the server.	Remove the files (including image files or hidden files) which the unit does not support, from the folder being played back.
	The media sharing setting is not correct.	Configure the sharing setting and select the unit as a device to which music contents are shared (☞ P.17).
	Some security software installed on your PC is blocking the access of the unit to your PC.	Check the settings of security software installed on your PC.
The unit does not detect the PC.	The unit and PC are not in the same network.	Check the network connections and your router settings, and then connect the unit and the PC to the same network.
	The MAC address filter is enabled on the unit.	In [Advanced Setup] in the option menu of the unit, set [MAC Add.Filter] to [OFF] (☞ P.32).
	Your PC is connected to the secondary SSID of a router supporting multi SSID.	When your PC is connected to the secondary SSID, access to the device connecting to the primary SSID or LAN is restricted (only Internet access is available). Connect your PC to the primary SSID.
	Multiple routers are connected between your network devices (double router).	Disconnect Internet temporarily, check the local network, and connect the network device you wish to use to the same router.
The files in the PC cannot be viewed or played back.	The files are not supported by the unit or the media server.	Use the file format supported by both the unit and the media server (☞ P.40).
Some files cannot be played back with the unit.	You are trying to play back files with DRM (Digital Rights Management) purchased on iTunes Store.	Files with DRM (Digital Rights Management) purchased on iTunes Store cannot be played back.
	The selected Internet radio station is currently not available.	There may be a network problem at the radio station, or the service may have been stopped. Try the station later or select another station.
	The selected Internet radio station is currently broadcasting silence.	Some Internet radio stations broadcast silence at certain of times of the day. Try the station later or select another station.
The Internet radio cannot be played.	Access to the network is restricted by the firewall settings of your network devices (such as the router).	Check the firewall settings of your network devices. The Internet radio can be played only when it passes through the port designated by each radio station. The port number varies depending on the radio station.

Problem	Cause	Solution
The application dedicated to mobile devices does not detect the unit.	The MAC address filter is enabled on the unit.	In [Advanced Setup] in the option menu of the unit, set [MAC Add.Filter] to [OFF] or specify the MAC address of your mobile devices to allow it to access to the unit (☞ P.32).
	The unit and mobile devices are not in the same network.	Check the network connections and your router settings, and then connect the unit and mobile device to the same network.
	Your mobile device is connected to the secondary SSID of a router supporting multi SSID.	When your mobile device is connected to the secondary SSID, access to the device connecting to the primary SSID or LAN is restricted (only Internet access is available). Connect your mobile device to the primary SSID.
	Multiple routers are connected between your network devices (double router).	Disconnect Internet temporarily, check the local network, and connect the network device you wish to use to the same router.
Update of the firmware via network failed.	The network connection is unstable.	Try updating again after a while. Or update the firmware via USB memory (☞ P.30).



iPod

Problem	Cause	Solution
No sound.	The iPod is not connected properly.	Reconnect the iPod to the USB jack (☞ P.15).
	The iPod software version is out of date.	Download the latest iTunes software from Apple's website to update the iPod software version.
	The iPod is in the process of connecting with the unit.	Please wait for a while.
	The iPod is not supported by this unit.	Use a supported iPod (☞ P.39).
The iPod cannot be operated by the iPod, unit, or remote control.	The iPod is not connected properly.	Reconnect the iPod to the USB jack (☞ P.15).
	The iPod software version is out of date.	Download the latest iTunes software from Apple's website to update the iPod software version. If the problem cannot be solved, even with the latest software, reset the iPod.
	When the display mode for iPod is set to the standard mode, the unit or remote control cannot control an iPod. When in the extended mode, iPod does not function for controlling itself.	Check the display mode. (☞ P.16)
The playback information is not shown on the front panel display.	The iPod does not support display of playback information.	This function is only available with an iPod suitably supported by this unit (☞ P.39).
	The display mode is set to the standard mode.	Change the display mode to the extended mode (☞ P.16).

Troubleshooting

Problem	Cause	Solution
The iPod does not charge up.	The iPod is not connected properly.	Reconnect the iPod to the USB jack (☞ P.15).
	The iPod is not supported by this unit.	Use a supported iPod (☞ P.39).
	The unit is in the eco standby mode.	Set [Power Saving] to [Normal] with the option setting (☞ P.12).

Disc

Problem	Cause	Solution
Playback does not start after a disc is set. Some button operations do not work.	The disc set into the unit may not be compatible.	Use a disc supported by the unit (☞ P.39).
	The disc may be dirty.	Wipe the disc clean (☞ P.39).
Playback does not start immediately after pressing  on the unit or  on the remote control (stops immediately).	The disc set in the unit may not be supported.	Use the disc supported by the unit (☞ P.39).
	If the unit was moved from a cold to warm place, condensation may have formed on the disc reading lens.	Wait for an hour or two until the unit adjusts to the room temperature, and try again.

USB devices

Problem	Cause	Solution
The unit does not detect the USB device.	The USB device is not connected to the USB jack securely.	Turn off the unit, reconnect your USB device, and turn the unit on again (☞ P.15).
	The file system of the USB device is not FAT16 or FAT32.	Use a USB device with FAT16 or FAT32 format.
Folders and files in the USB device cannot be viewed.	The data in the USB device is protected by the encryption.	Use a USB device without an encryption function.

FM reception

Problem	Cause	Solution
FM stereo reception is noisy.	The antenna is not connected properly.	Make sure the antenna is connected properly and change the position of the antenna (☞ P.10).
	The radio station you selected may be far from your area, or the antenna input is poor.	Use a commercially available outdoor antenna. For details, consult a specialist store.
Automatic tuning does not work.	The radio station you selected may be far from your area, or the antenna input is poor.	Use a commercially available outdoor antenna. For details, consult a specialist store.
		Use the manual tuning method (☞ P.23).
Cannot select a preset radio station.	The preset (memory) may have been erased.	Preset radio stations again (☞ P.23, 24).
There is distortion, and clear reception cannot be obtained even with a good FM antenna or an outdoor antenna.	Multipath reflection or other radio interference may have occurred.	Change the height, direction, or placement of the antenna.

Messages on the front panel display

Message	Cause	Solution
Unknown	There is a problem with the signal path from your iPod to this unit.	Reconnect the iPod.
	The iPod/USB device being connected is not supported by the unit.	Use a supported iPod/USB device (🔧 P.39).
	The iPod software is out of date.	Download the latest iTunes software from Apple's website to update the iPod software version.
Timer not work	The unit is in the eco standby mode.	Set [Power Saving] to [Normal] with the option setting (🔧 P.12).
Overcurrent	The connected iPod/USB device is not supported by the unit.	Disconnect the iPod/USB device, turn off the unit, and turn it on again. If this does not solve the problem for the USB device, it is not playable on the unit.
	iPod/USB device is not connected properly.	
Unplugged	iPod/USB device is not connected firmly.	Disconnect the iPod/USB device and reconnect it (🔧 P.15).
No Disc	The disc set in the unit may not be supported by the unit.	Use a disc supported by the unit (🔧 P.39).
	The disc may be dirty, or foreign objects may be attached to it.	Remove the disc and then wipe the disc clean.
	Disc is set upside-down.	Set the disc with the labeled side facing up.
No Songs	The disc does not contain playable files.	Set a disc with playable files (🔧 P.39).
Initializing	The unit is starting up.	Wait until the message disappears. If the message stays more than 3 minutes, turn off the unit and turn it on again.
Loading...	The unit is loading the specified file/contents.	Wait until the unit finishes loading.
No Content	Selected folder does not contain playable files.	Select a folder with playable files (🔧 P.40).
Not Connected	The unit is not connected to the Internet.	Check the Internet connection.
Unsupported	You are trying to play back a file which the unit does not support.	Play a file supported by the unit (🔧 P.40).
No Operation	You are trying to open the disc tray while setting the option menu.	Open the disc tray after the option setting is finished.
Access Denied	Access to the PC is denied.	Configure the sharing settings and select the unit as a device to which music contents are shared (🔧 P.17).
Access Error	The unit cannot access the USB device.	Turn off the unit and reconnect your USB device. If the problem persists, try another USB device.
	The unit cannot access the iPod.	Turn off the iPod and turn it on again.
	The connected iPod is not supported by the unit.	Use an iPod supported by the unit (🔧 P.39).
	There is a problem with the signal path from the network to the unit.	Make sure your router and modem are turned on. Check the connection between the unit and your router (or hub) (🔧 P.11).
Version Error	Firmware update is failed.	Update the firmware again.

Supported devices/media and file formats

Supported devices/ medias

PCs

PC with Windows Media Player 11 or Windows Media Player 12 installed.

NAS

NAS that is compatible with DLNA version 1.5.

USB devices

- This unit supports USB mass storage class devices (e.g., flash memories or portable audio players) using FAT16 or FAT32 format.
- Do not connect devices other than USB mass storage class devices (such as USB chargers or USB hubs), PCs, card readers, an external HDD, etc.
- USB devices with encryption cannot be used.

iPod

iPod	iPod touch (1st, 2nd, 3rd, 4th and 5th generations), iPod nano (2nd, 3rd, 4th, 5th, 6th and 7th generations)
iPhone	iPhone 5, iPhone 4S, iPhone 4, iPhone 3GS, iPhone 3G, iPhone
iPad	iPad (4th generation), iPad mini, iPad (3rd generation), iPad 2, iPad

(As of August 2013)

Note

iPod is licensed on the condition that individuals perform privately duplication and playback of uncopyrighted material or material legally approved of duplication and playback. Infringement of copyright is prohibited by law.

Discs

- This unit is designed for use with audio CD, CD-R/RW (ISO 9660 format) with any of the following logos printed on the disc or the disc jacket.

Audio CD



CD-R/RW*



* Discs which bear one of the following.
FOR CONSUMER
FOR CONSUMER USE
FOR MUSIC USE ONLY

- 8-cm discs are playable with this unit.
Set a disc in the inner recessed area of the disc tray.

Notes on discs

- Do not set any other type of disc other than stated above in this unit. Doing so may damage the unit.
- CD-R/RW cannot be played back unless finalized.
- Some discs cannot be played back depending on the disc characteristics or recording conditions.
- Do not use any non-standard shaped discs such as a heart-shaped disc.
- Do not use discs with many scratches or a crack on their surface, or warped/glued discs.

Handling discs

- Do not touch the surface of the disc.
Hold a disc by its edge or center hole.
- Use a soft-tipped pen when writing on the label side of a disc.
- Do not put tape, seal, glue, etc., on a disc.
- Do not use a protective cover to prevent scratches.
- Do not set foreign object on the disc tray.
- Do not set more than one disc in this unit at one time. This could cause damage to both this unit and the discs.
- If a disc becomes dirty, wipe it with a clean, dry soft cloth from the center out to the edge. Do not use record cleaner or paint thinner.
- Do not use any lens cleaners as they may cause malfunction.
- Do not expose discs to direct sunlight, high temperature, high humidity, or dust.
- When a disc is not being used, remove it from this unit and store in an appropriate case.

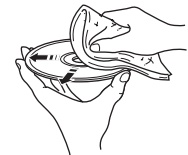

File format

File format the unit supporting is as follows.

DLNA/USB

- The unit supports playback of WAV (PCM format only), MP3, WMA, MPEG-4 AAC and FLAC files (1- or 2-channel audio only).
- The unit is compatible with sampling rates of up to 192 kHz for WAV and FLAC files, and 48 kHz for other files.
- To play back FLAC files, you need to install server software that supports sharing of FLAC files via DLNA on your PC or use a NAS that supports FLAC files.
- Digital Rights Management (DRM) contents cannot be played back.

Discs

- The unit supports playback of MP3 and WMA files with a sampling rate of up to 48 kHz.
- The unit is compatible with both constant and variable bitrates of from 8 to 320 kbps for MP3 files, and from 16 to 320 kbps for WMA files.
- This unit can play back a maximum of 512 files, 255 folders (maximum of 511 files in a folder).
- Digital Rights Management (DRM) files cannot be played back.



AirPlay works with iPhone, iPad, and iPod touch with iOS 4.3.3 or later, Mac with OS X Mountain Lion, and Mac and PC with iTunes 10.2.2 or later.

"Made for iPod," "Made for iPhone," and "Made for iPad" mean that an electronic accessory has been designed to connect specifically to iPod, iPhone, or iPad, respectively, and has been certified by the developer to meet Apple performance standards.

Apple is not responsible for the operation of this device or its compliance with safety and regulatory standards.

Please note that the use of this accessory with iPod, iPhone, or iPad may affect wireless performance.

AirPlay, iPad, iPhone, iPod, iPod nano, iPod touch and iTunes are trademarks of Apple Inc., registered in the U.S. and other countries.



Fraunhofer Institut Integrierte Schaltungen

MPEG Layer-3 audio coding technology licensed from Fraunhofer IIS and Thomson.



This unit supports network connections.



DLNA™ and DLNA CERTIFIED™ are trademarks or registered trademarks of Digital Living Network Alliance. All rights reserved. Unauthorized use is strictly prohibited.

Windows™

Windows is a registered trademark of Microsoft Corporation in the United States and other countries.

Internet Explorer, Windows Media Audio and Windows Media Player are either registered trademarks or trademarks of Microsoft Corporation in the United States and/or other countries.

Android™

Android and Google Play are trademarks of Google, Inc.

Specifications

Player section

CD	Media		CD, CD-R/RW
	Audio format		Audio CD, MP3, WMA
	Laser	Type	Semiconductor laser GaAs/GaAlAs
		Wave length	790 nm
Output power		10 mW	
iPod (digital connection)	Supported iPod		See page 39.
	Supported iPhone		
	Supported iPad		
USB	Supported file format		MP3, WMA, MPEG4 AAC, WAV*, FLAC* * up to 192 kHz/24 bit
AUX IN	Input connector	AUX1	Stereo L/R: RCA
		AUX2	3.5 mm stereo mini jack
DIGITAL IN	Input connector	DIGITAL IN 1	Optical
		DIGITAL IN 2	Coaxial
Network	Interface		100Base-TX/10Base-T
	Internet radio		vTuner service supported
	PC client function		DLNA Ver. 1.5 (DMP/DMR function) supported
	Supported file format		MP3, WMA, MPEG4 AAC, WAV*, FLAC* * up to 192 kHz/24 bit
	AirPlay		AirPlay supported

Tuner section

Tuning range (FM)	87.50 to 108.00 MHz
-------------------	---------------------

Amplifier section

Maximum output power	32 W + 32 W (6 Ω 1 kHz, 10% THD)
Total harmonic distortion AUX1 1 kHz/12.5 W	0.05% or less
EQ control	EQ High (treble)/EQ Mid (middle)/EQ Low (bass): ±10 dB
Headphones	Stereo L/R: 3.5mm stereo mini jack Adapted impedance: 16 Ω - 32 Ω

General

Power supply	Asia model	AC 220-240 V, 50/60 Hz
	Taiwan model	AC110-120 V, 60 Hz
	China model	AC 220 V, 50 Hz
	Korea model	AC 220 V, 60 Hz
Power consumption		44 W
Power consumption in the standby mode		6 W or less
Power consumption in the eco standby mode		0.5 W or less
Dimensions (W × H × D)		215 × 110 × 288 mm (8-1/2 × 4-3/8 × 11-3/8 in)
Weight		2.7 kg (6.0 lbs.)

(As of August 2013)
Specifications are subject to change without notice.

Índice

Introducción.....4

Accesorios suministrados.....4
Acerca de este manual.....4

Nombre de la pieza.....5

Panel delantero.....5
Panel trasero.....6
Visualizador del panel delantero.....7
🔍 Ajuste del brillo de la pantalla.....7
Mando a distancia.....8

Preparativos.....9

Conexión de los altavoces.....9
Conexión de la antena.....10
Conexión a la red.....11
Encendido de la unidad.....12

Ajuste de los dispositivos de red.....13

PC.....13
NAS.....13
Dispositivos móviles.....13

Escuchar CD.....14

Escuchar iPod/dispositivos USB.....15

Reproducir iPod.....15
Reproducir dispositivos USB.....15

Escuchar canciones en el ordenador.....17

Configuración del uso compartido de multimedia de los archivos de música.....17
Reproducción de canciones en el PC.....18

Escuchar fuentes externas.....19

Más información sobre la reproducción.....20

Reproducción aleatoria.....20
Reproducción repetida.....20
Información de reproducción.....21
Ajuste de la calidad del sonido.....22

Escuchar emisoras de radio FM.....23

Sintonizar emisoras FM.....23
Memorización de emisoras FM.....23
Selección de emisoras FM memorizadas.....24
🔍 Eliminación de una emisora memorizada.....24

Escuchar radio por Internet.....25

Escuchar música con AirPlay.....26

Reproducir iPod.....26
Reproducir iTunes.....26

Utilización del reloj.....27

Ajuste del reloj.....27
Ajuste del temporizador de activación.....28
Temporizador de apagado.....29

Actualización del firmware.....30

Ajustes de opciones.....31

Lista de opciones del menú.....32

Resolución de problemas.....33

General.....33
Red.....34
iPod.....35
Disco.....36
Dispositivos USB.....36
Recepción FM.....37
Mensajes del visualizador del panel delantero.....38

Dispositivos, soportes y formatos de archivo compatibles.....39

Especificaciones.....41

Información sobre el software.....42

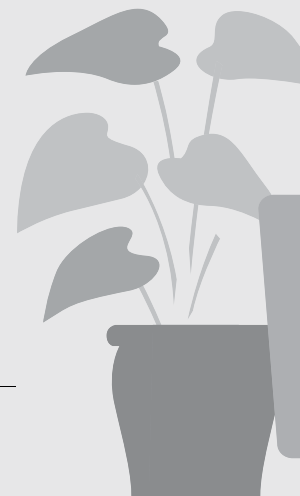

¡Increíble! ¡Un sonido espectacular!

¡La música del ordenador suena como nunca!.....17, 18

Sonido de alta resolución.....22

¡Mi música en cualquier parte!

¡La app más práctica! El smartphone como mando a distancia.....18

Escuchar las canciones de mi iPhone por los altavoces de forma inalámbrica.....26

Más información sobre la música

Conexión de diferentes dispositivos externos (reproductor de Blu-ray/ DVD/portátil, etc.)..... 19

Escuchar radio por Internet desde mi sistema de audio..... 25

Introducción

Compruebe los contenidos del paquete y los puntos más importantes de este manual.

Accesorios suministrados

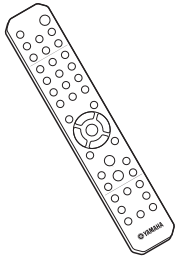

Mando a distancia

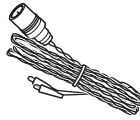

Antena FM

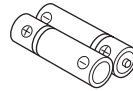

Pilas (x 2)
(AA, R6, UM-3)

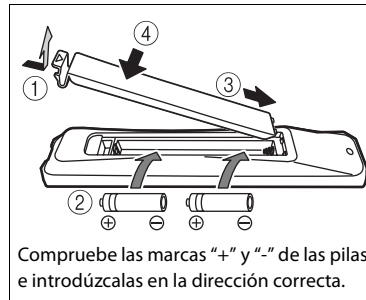

Acerca de este manual

- Las instrucciones de utilización de la unidad utilizan como ejemplo principalmente el mando a distancia.
- Las ilustraciones pueden no coincidir con el producto real.
- En este manual, "iPod" se utiliza también en referencia a un "iPhone" o un "iPad".
- Símbolos:



Indica precauciones de uso de la unidad y las limitaciones.



Indica explicaciones complementarias para mejorar el uso.



Indica la página o las páginas de referencia correspondientes.



- Cambie las dos pilas cuando la distancia de funcionamiento del mando a distancia disminuya.

Nombre de la pieza

Familiarícese con todas las piezas y sus funciones.

Panel delantero

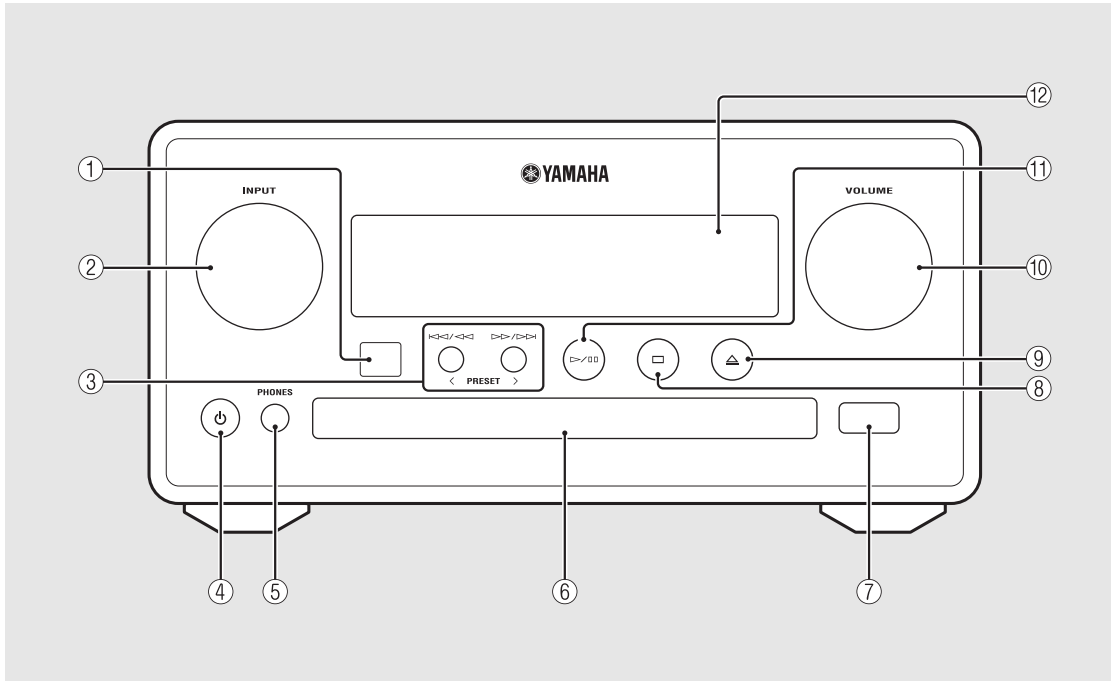

- ① Receptor de mando a distancia
- ② INPUT
Gire hacia la izquierda o la derecha para cambiar la fuente de audio. (La fuente aparece en el visualizador del panel delantero.)
- ③ ◀◀/▶▶ ▶▶/▶▶ (↻ P.14, 16, 18)
PRESET</> (↻ P.24)
- ④ ⏻ (Encendido) (↻ P.12)
- ⑤ PHONES
Toma para conectar auriculares.
- ⑥ Bandeja de disco (↻ P.14)
- ⑦ Toma USB (↻ P.15)
- ⑧ □ (Parada) (↻ P.14, 16, 18, 25)
- ⑨ ≡ (Abrir/cerrar la bandeja de disco) (↻ P.14)
- ⑩ VOLUME
Controlan el volumen.
- ⑪ ▶/▢ (Reproducción/pausa) (↻ P.14, 16, 18)
- ⑫ Visualizador del panel delantero (↻ P.7)

Panel trasero

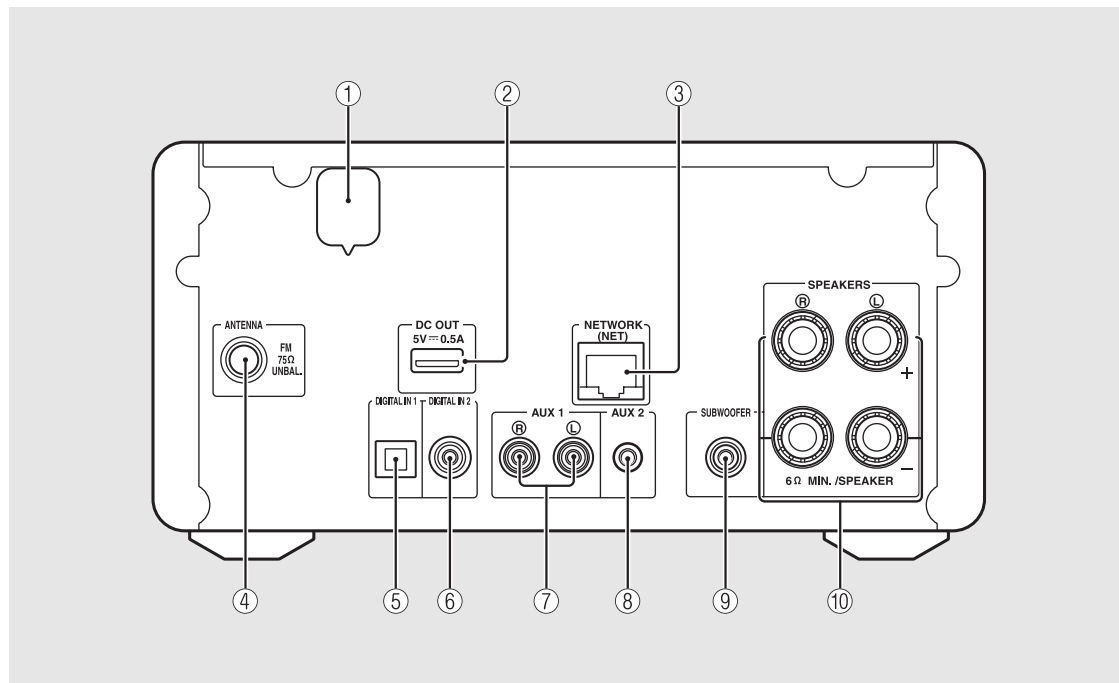

① Cable de alimentación (↪ P.12)

② Terminal DC OUT

Proporciona alimentación a los accesorios AV de Yamaha desde este terminal. Al utilizar este terminal, ajuste [Use Accessory] en el apartado [System Config] de los ajustes de opciones, en [YES] (↪ P.31). Para obtener más información, consulte el manual de instrucciones suministrado con el accesorio.

③ Terminal NETWORK (↪ P.11)

Para la conexión con una red mediante un cable de red disponible en el mercado.

④ Terminal de antena FM (↪ P.10)

⑤ Terminal DIGITAL IN 1 (entrada óptica) (↪ P.19)

⑥ Terminal DIGITAL IN 2 (entrada coaxial) (↪ P.19)

⑦ Terminal AUX 1 (entrada RCA) (↪ P.19)

⑧ Terminal AUX 2 (entrada de minitoma) (↪ P.19)

⑨ Terminal SUBWOOFER (↪ P.9)

⑩ Terminal SPEAKERS (↪ P.9)

Visualizador del panel delantero

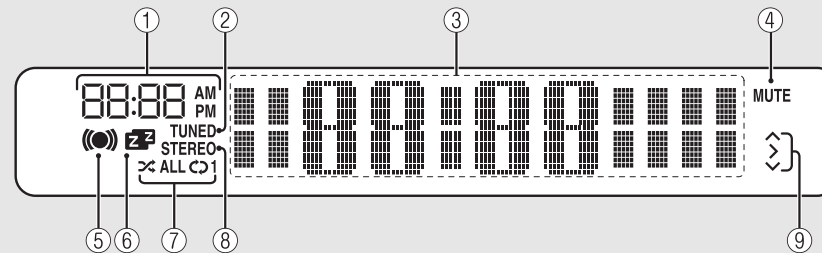

① Reloj

Muestra la hora cuando la alimentación está activada.

② Indicador TUNED

Se enciende cuando la unidad sintoniza una emisora.

③ Visualizador de información múltiple

Muestra diferentes datos, como el reloj en el modo de espera, información musical o frecuencias de radio (solo caracteres alfanuméricos).

④ Indicador MUTE

Se enciende cuando el sonido se silencia (☞ P.8).

⑤ Indicador del temporizador de activación

Parpadea durante el ajuste del temporizador de activación y queda encendido una vez ajustado el temporizador (☞ P.28).

⑥ Indicador del temporizador de apagado

Se enciende cuando el temporizador de apagado está ajustado (☞ P.29).

⑦ Indicador de reproducción aleatoria/repetición

Se enciende cuando configura el iPod, un CD, un dispositivo USB o un ordenador para la reproducción aleatoria o la repetición de la reproducción (☞ P.20).

⑧ Indicador STEREO

Se enciende cuando la unidad está recibiendo una señal intensa de una emisión estéreo FM.

⑨ Indicadores de funcionamiento

Muestra los botones de control disponibles ▲/▼/ENTER (☞ P.8) del mando a distancia.



Ajuste del brillo de la pantalla

Puede ajustar el brillo del visualizador del panel delantero pulsando el botón **DIMMER** del mando a distancia (☞ P.8).

- Con cada pulsación del botón, el brillo cambia entre brillante (opción predeterminada), medio o apagado.

Mando a distancia

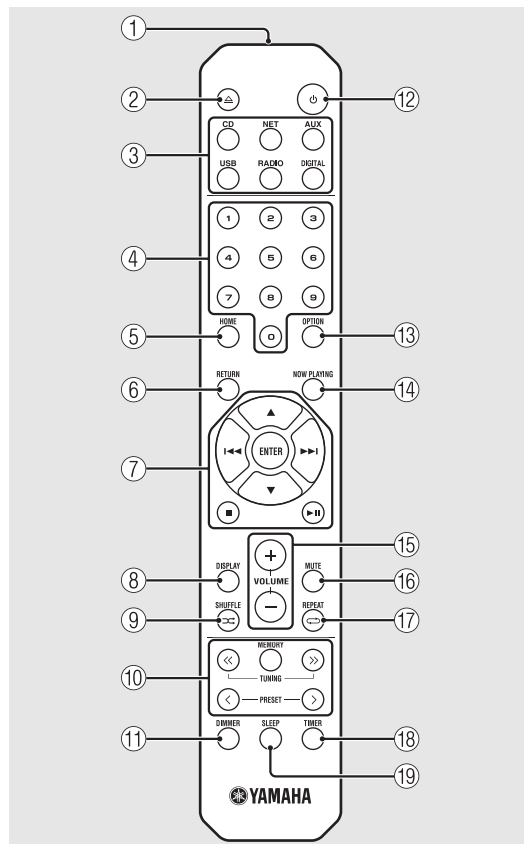

- ① Transmisor de señal infrarroja
- ② (Abrir/cerrar la bandeja de disco) (↪ P.14)
- ③ Botones de fuente
Permiten cambiar la fuente de audio reproducida.
- ④ Botones numéricos (↪ P.14)
- ⑤ HOME (↪ P.16, 18, 25)
- ⑥ RETURN (↪ P.14, 16, 18, 25)
- ⑦ Control de audio, botones de control de cursor
(↪ P.14, 16, 18, 25)
- ⑧ DISPLAY (↪ P.21)
- ⑨ (SHUFFLE) (↪ P.20)
- ⑩ Botones de control FM (↪ P.23, 24)
- ⑪ DIMMER (↪ P.7)
- ⑫ (Encendido) (↪ P.12)
- ⑬ OPTION (↪ P.22, 27, 31)
- ⑭ NOW PLAYING (↪ P.16, 18, 25)
- ⑮ VOLUME +/-
Controlan el volumen.
- ⑯ MUTE
Activa o desactiva el sonido.
- ⑰ (REPEAT) (↪ P.20)
- ⑱ TIMER (↪ P.28)
- ⑲ SLEEP (↪ P.29)

Preparativos

Conecte los altavoces o la antena y encienda la unidad.

No conecte el cable de alimentación de la unidad hasta que haya terminado de conectar todos los cables.

Conexión de los altavoces

- 1 Retire el aislamiento del extremo del cable de los altavoces para dejar al descubierto los hilos expuestos.

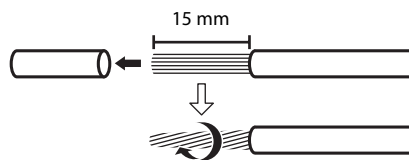

- 2 Conecte el altavoz a la unidad, tal y como muestra la ilustración.

- Prepare los altavoces y los cables de los altavoces por separado.
- Para obtener más información sobre la conexión de los altavoces, consulte el manual de instrucciones suministrado con el producto.

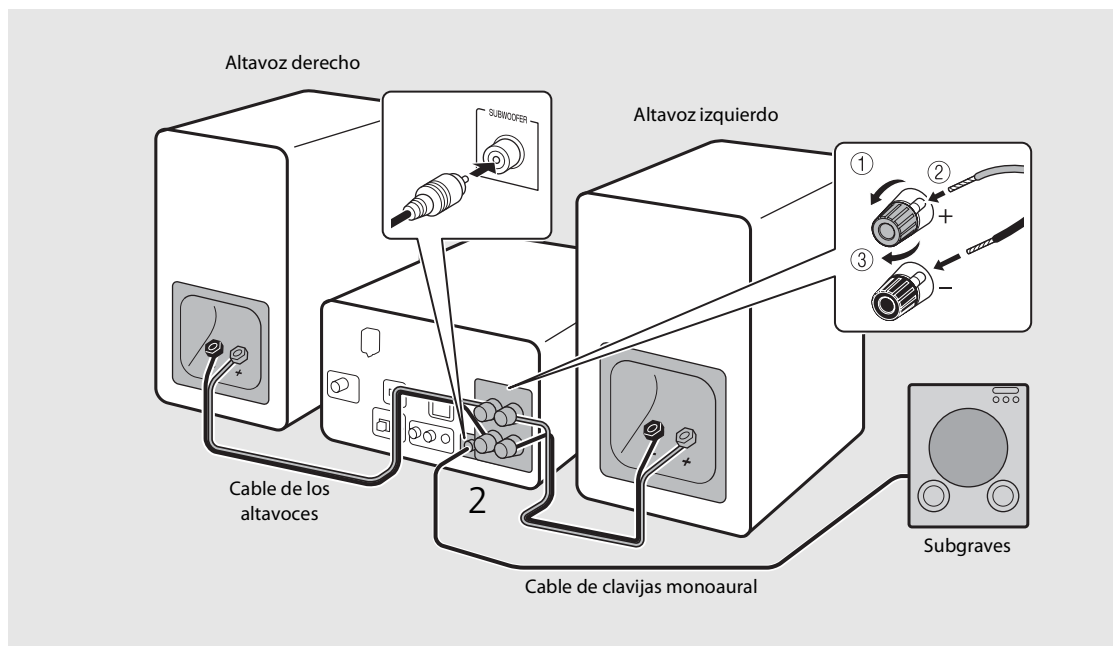

- No deje que los cables de altavoces desnudos entren en contacto entre sí ni toquen partes metálicas de la unidad, ya que podrían dañar la unidad y/o los altavoces.
- Asegúrese de que las conexiones izquierda y derecha (L, R) y la polaridad (rojo: +, negro: -) son correctas. Si las conexiones son incorrectas, el sonido no será natural.
- Utilice unos altavoces con una impedancia mínima de 6 Ω .
- También puede conectar un subwoofer con amplificador incorporado a la unidad.

Conexión de la antena

- 1 Conecte la antena suministrada a la unidad.
- 2 Fíjela con chinchetas en un lugar que permita obtener una buena recepción.

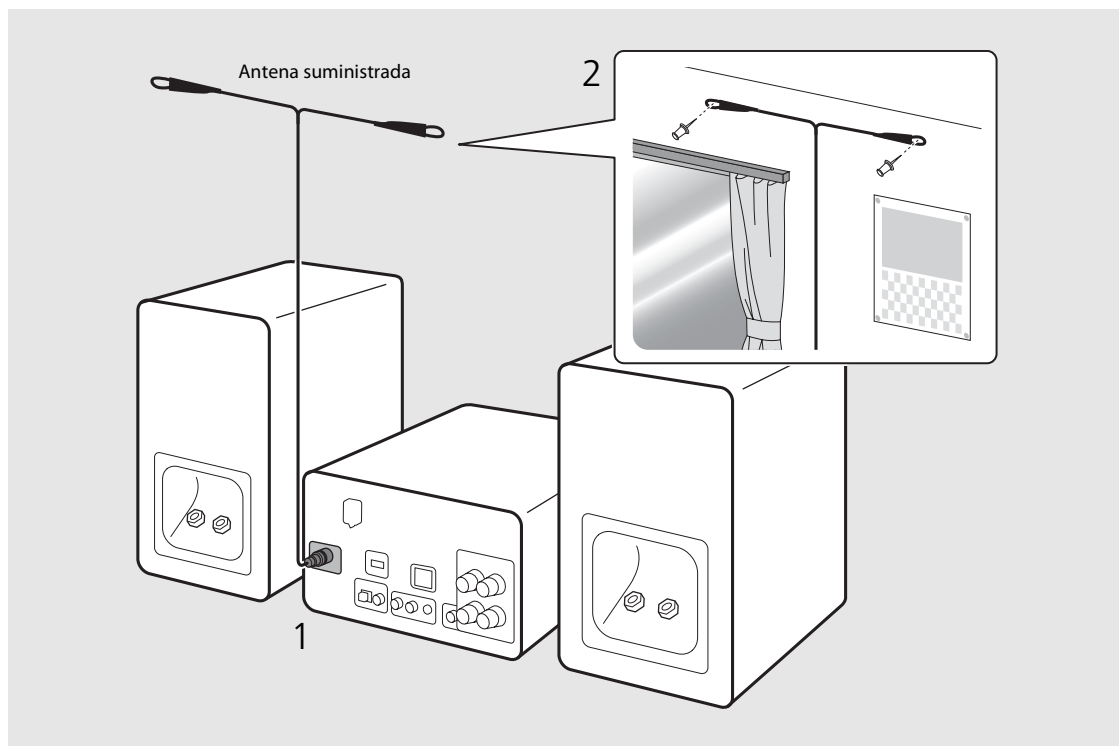

- Asegúrese de extender la antena tal y como muestra la ilustración.
- Si la recepción de radio con la antena suministrada no es buena, es posible adquirir por separado una antena exterior para mejorar la recepción.

Conexión a la red

Puede reproducir archivos de música almacenados en su PC, en dispositivos móviles, en NAS compatibles con DLNA* o contenidos de audio de Internet conectando esta unidad a la red. También puede controlar la unidad desde su dispositivo móvil.

* Digital Living Network Alliance

Conecte la unidad a la red tal y como se muestra en la parte derecha.

- Realice la conexión con un cable de red STP (par trenzado con protección) disponible en el mercado (cable de conexión directa CAT-5 o superior).

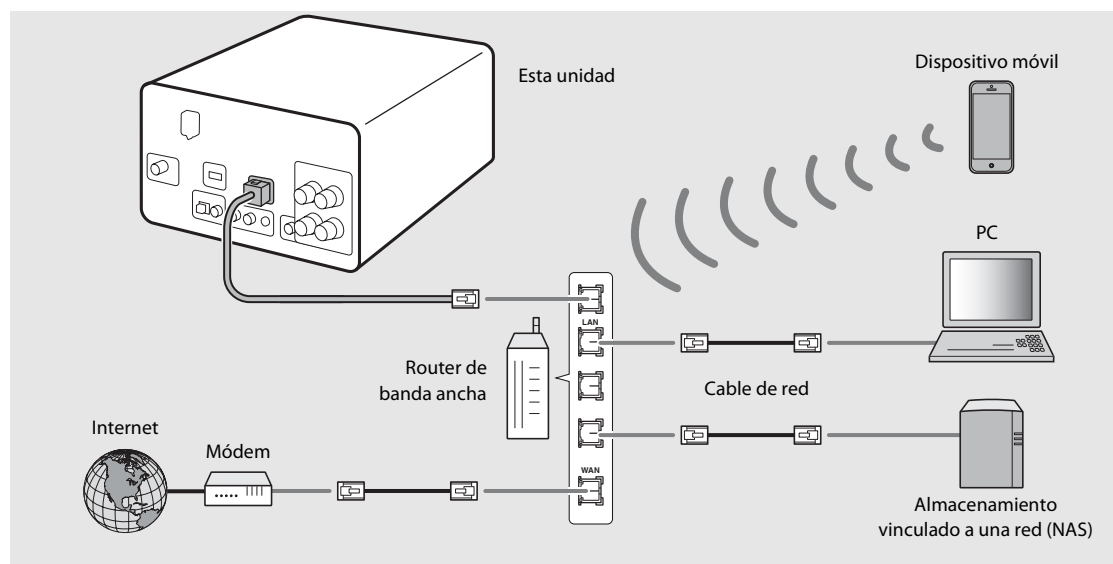

- Para obtener más información sobre la conexión a Internet, consulte los manuales de instrucciones de sus dispositivos de red.
- Si utiliza un router compatible con DHCP, no es necesario realizar la configuración de red de la unidad. Si utiliza un router no compatible con DHCP, realice la configuración de la red en [Network Config], en los ajustes de opciones (☞ P.31).
- En los dispositivos que no sean móviles, se recomienda realizar la conexión con cables para obtener un sonido de mayor calidad.
- Cierta software de seguridad instalado en el equipo o la configuración del firewall de los dispositivos de red (como un enrutador), podrían impedir el acceso de la unidad a los dispositivos de red o a Internet. En este caso, modifique la configuración del software de seguridad o los dispositivos de red.
- Si configura manualmente la subred, todos los servidores deben estar conectados a la misma subred que la unidad (☞ P.32).

Encendido de la unidad

Conecte el cable de alimentación en la toma de corriente y pulse .

- La unidad se enciende.
- Pulse  de nuevo para apagarla (modo de espera).
- El “modo de espera Eco” (predeterminado) reduce el consumo de alimentación de la unidad, aunque limita algunas de sus funcionalidades (tal y como muestra la tabla de la parte derecha).

Cancelación del modo de espera Eco

1 Pulse .

- Aparece el menú de opciones en el visualizador del panel delantero.

2 Cancele el modo de espera Eco.

- Puede acceder a la opción a través de la siguiente ruta: [System Config] - [Power Saving] - [Normal].
- Modifique la opción con los botones ▲/▼ y pulse  para confirmar.

3 Pulse  para finalizar el ajuste.

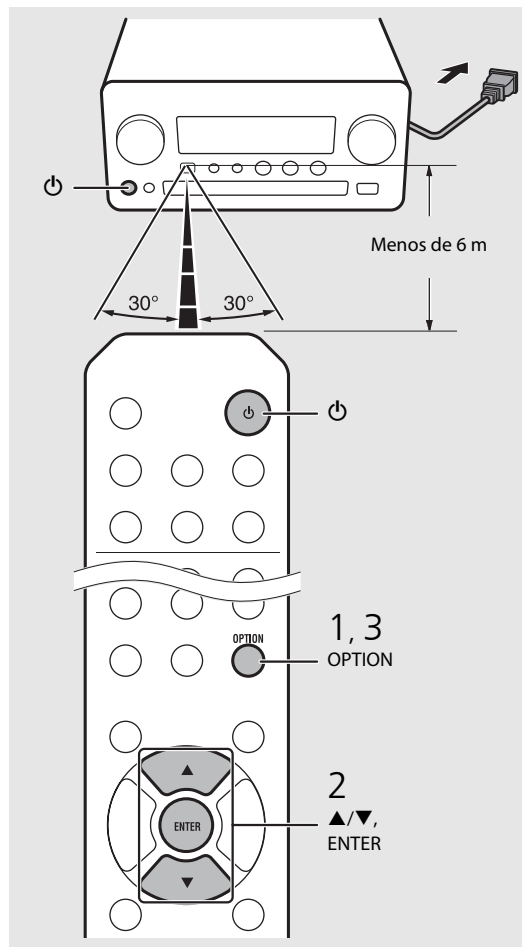

Estado en el modo de espera/espera Eco

	Espera	Espera Eco
Carga de iPod/dispositivos USB	✓	—
Activación/desactivación del temporizador de activación*	✓	—
Utilización de los botones de fuente*	✓	✓
Carga/expulsión de CD	✓	✓
AirPlay	✓	—
Encendido controlado por la aplicación	✓	—
Visualización del reloj	✓	—

* Funcionamiento solo con mando a distancia

Opciones de alimentación del menú (System Config)

(Valor de ajuste. **Negrita: predeterminado**)

Power Saving

Configure los ajustes de alimentación.
(Normal, **Eco**)

Al seleccionar [Eco], no aparece nada en el visualizador del panel delantero en el modo de espera Eco.

Auto Power Off

Ajuste la hora a la que la unidad entrará en el modo de espera si no se realiza ninguna operación.
(Timer 2H, Timer 4H, **Timer 8H**, Timer 12H, OFF)

Ajuste de los dispositivos de red

Configure sus dispositivos conectados a la red para reproducir archivos de música almacenados en su PC o NAS o configure su dispositivo móvil para controlar esta unidad.

PC

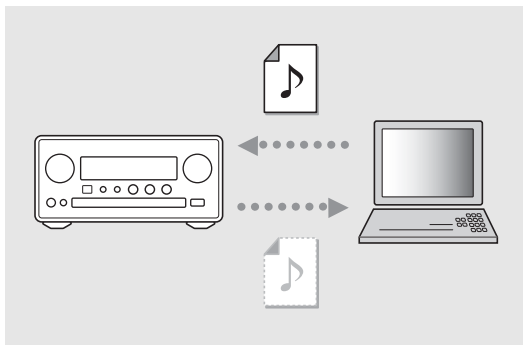

Configure el uso compartido de multimedia de su PC (☞ P.17).

NAS

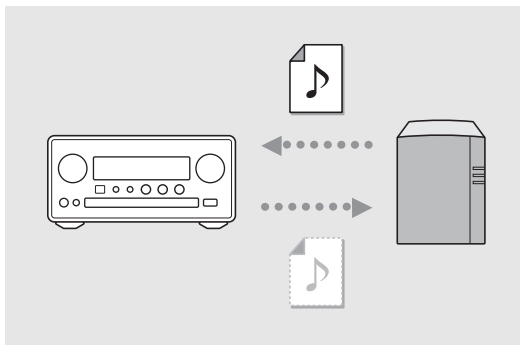

Configure los ajustes para acceder a su NAS.

- Si es necesario, active la configuración DHCP de su NAS.
- Para obtener más información, consulte el manual de instrucciones suministrado con su NAS.

Dispositivos móviles

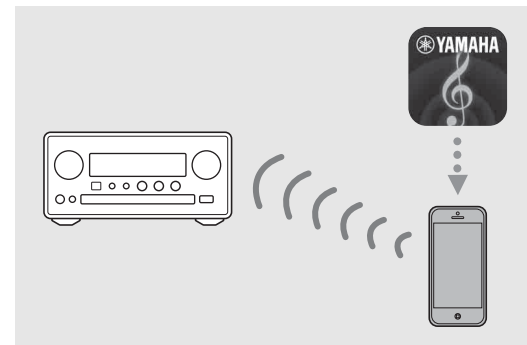

Instale la aplicación especial "NETWORK PLAYER CONTROLLER" en sus dispositivos móviles (☞ P.18).

- La aplicación es compatible con dispositivos iPhone/iPad/iPod touch y Android.
- El dispositivo móvil tiene que estar conectado al mismo router que la unidad.

Escuchar CD

Esta unidad permite la reproducción de CD de audio y CD de datos con archivos MP3/WMA grabados.

Para obtener información sobre los CD que pueden reproducirse, consulte "Dispositivos y soportes compatibles" (P.39).



1 Gire INPUT para seleccionar [CD]. O bien pulse  en el mando a distancia.

2 Introduzca un CD en la bandeja de disco.

- Pulse  para abrir/cerrar la bandeja de disco.

3 Se inicia la reproducción.

- Las funciones del mando a distancia se detallan a continuación.

	Salta al primer archivo de la carpeta anterior o siguiente al reproducir archivos MP3/WMA.
	Reproducción/pausa
	Parada
	Salta al principio de la canción reproducida o a la canción anterior.
	Salta a la siguiente canción.
	Inicia la reproducción aleatoria (☞ P.20).
	Inicia la reproducción de repetición (☞ P.20).
1 - 9, 0	Especifica el número de canción.
RETURN	Cancela el número de canción.
ENTER	Aplica el número de canción.

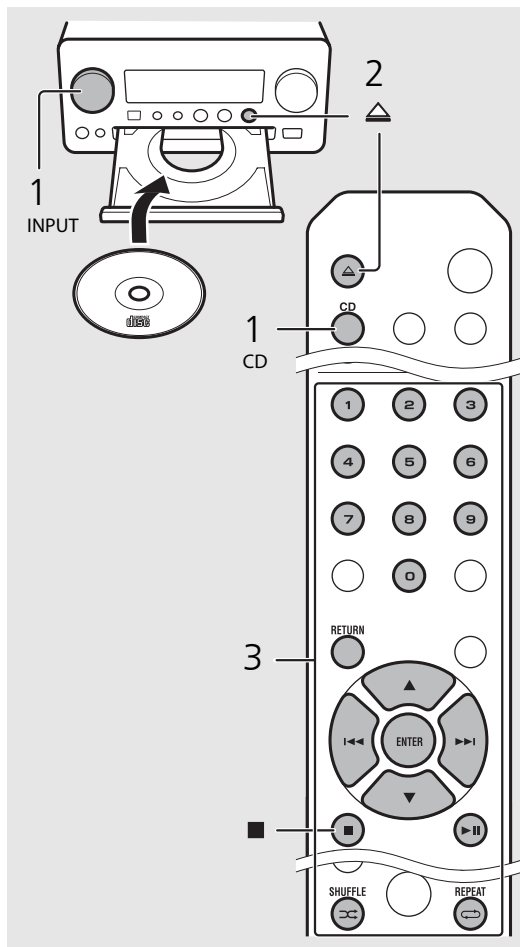



- Los archivos de un CD de datos se reproducen en orden alfanumérico.
- Cuando se detiene un CD de datos, la reproducción se reanuda desde el principio de la última canción reproducida. Si pulsa  con la reproducción detenida, se cancelará la reanudación de la reproducción.

Escuchar iPod/dispositivos USB



Esta unidad permite reproducir iPod o dispositivos USB con archivos de música grabados.

Para obtener información sobre los iPod o dispositivos USB que pueden reproducirse, consulte "Dispositivos, soportes y formatos de archivo compatibles" (P.39).

Reproducir iPod

- 1 Gire INPUT para seleccionar [USB] o pulse  en el mando a distancia.
- 2 Conecte el iPod a la toma USB.
 - Prepare el cable USB suministrado con su iPod.
 - La fuente cambia a [iPod].
- 3 Se inicia la reproducción ( P.16).

Reproducir dispositivos USB

- 1 Gire INPUT para seleccionar [USB]. O bien pulse  en el mando a distancia.
- 2 Conecte un dispositivo USB al puerto USB.
- 3 Se inicia la reproducción ( P.16).

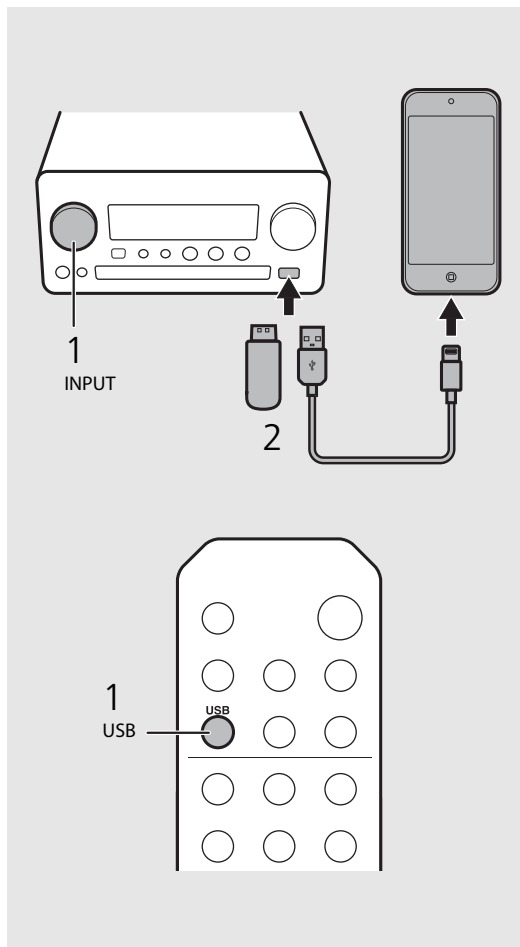







- Es posible que algunos iPod o dispositivos USB no funcionen correctamente aunque cumplan con los requisitos. No se garantizan la reproducción y alimentación de todos los iPod o dispositivos USB.
- Yamaha y sus proveedores declinan toda responsabilidad por la pérdida de los datos guardados en un iPod o dispositivo USB conectado a la unidad. Como medida de precaución, recomendamos realizar copias de seguridad de todos los archivos importantes.



- Interrumpa la reproducción antes de desconectar un dispositivo USB.
- Un iPod o dispositivo USB se carga automáticamente una vez conectado a la unidad, excepto en el modo de espera Eco.

Control de iPod/dispositivos USB con el mando a distancia

	Saltar al principio de la canción reproducida o la canción anterior (en el caso de un iPod, mantener pulsado para retroceder rápidamente).
	Saltar a la canción siguiente (en el caso de un iPod, mantener pulsado para avanzar rápidamente).
	Parada
	Reproducción/pausa
	Reproducción aleatoria (↻ P.20)
	Repetición de reproducción (↺ P.20)

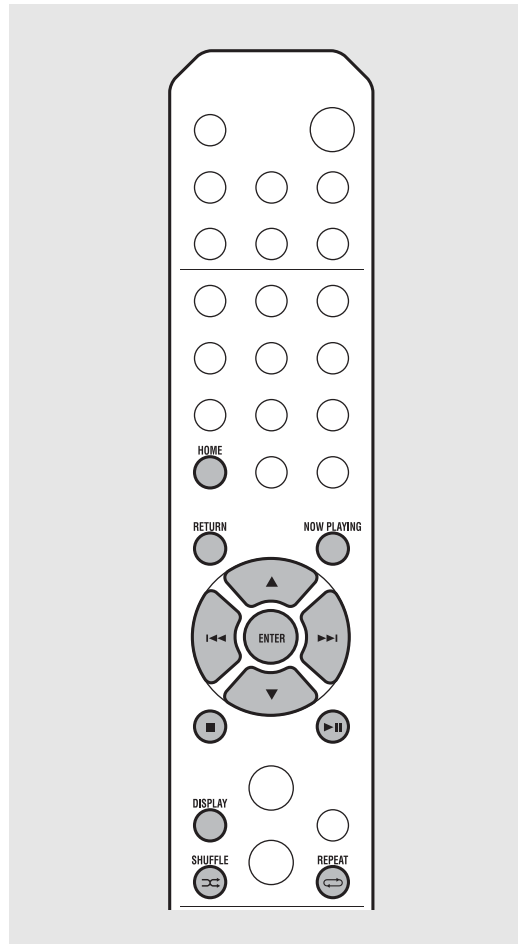

Cambio del modo de visualización de un iPod

- Si controla el iPod con la aplicación de Yamaha "NETWORK PLAYER CONTROLLER", la información mostrada se presenta en el modo ampliado. Para cambiar de modo de visualización de la información, mantenga pulsado el botón **DISPLAY**.

- **Modo estándar** (predeterminado): mientras utiliza el iPod, puede ver la pantalla del iPod y seleccionar la canción que desea reproducir.
- **Modo ampliado**: utilizando el mando a distancia, puede ver la información del iPod en el visualizador del panel delantero (navegación) y seleccionar la canción que desea reproducir. Las funciones del mando a distancia se detallan a continuación.

	Mostrar otra opción.
ENTER	Confirmar la opción seleccionada y pasar al siguiente nivel o iniciar la reproducción.
HOME	Mostrar la opción del nivel superior.
RETURN	Volver a la opción anterior.
NOW PLAYING	Fin de la exploración y visualización de la información de los contenidos reproducidos.

Escuchar canciones en el ordenador

Esta unidad permite reproducir archivos de música como MP3, WMA o FLAC (formato de compresión de datos de audio sin pérdida) almacenados en el ordenador (servidor) conectado a la red o NAS. Solo tiene que moverse por el visualizador del panel delantero y seleccionar el archivo de música que desee.

Configuración del uso compartido de multimedia de los archivos de música

Para reproducir archivos de música en su ordenador con esta unidad, tiene que configurar el uso compartido de multimedia entre la unidad y el ordenador (Reproductor de Windows Media 11 o posterior). En este ejemplo, se utiliza la configuración con Reproductor de Windows Media 12 y Windows 7.

- 1 Inicie Reproductor de Windows Media 12 en su PC.
- 2 Seleccione "Transmitir" y, a continuación, "Activar la transmisión por secuencias de multimedia".
 - Aparece la ventana del panel de control del PC.
- 3 Haga clic en "Activar la transmisión por secuencias de multimedia".
- 4 Seleccione "Permitido" en la lista desplegable junto a "CRX-N560".
- 5 Haga clic en "Aceptar" para salir.

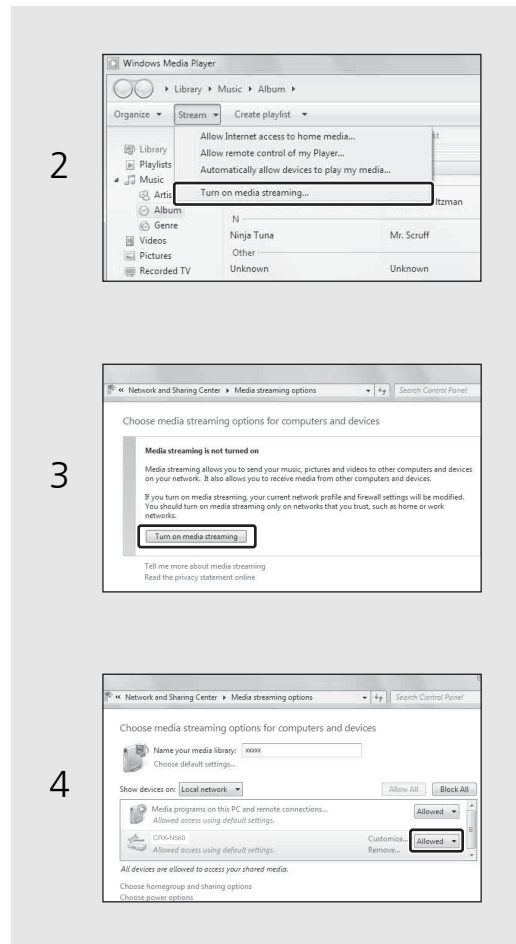

- Para obtener más información sobre la configuración del uso compartido de multimedia, consulte la ayuda del Reproductor de Windows Media.

Para Reproductor de Windows Media 11

- 1 Inicie el Reproductor de Windows Media 11 en su PC.
- 2 Seleccione "Biblioteca" y, a continuación, "Uso compartido de multimedia".
- 3 Marque la casilla "Compartir mi multimedia con", seleccione el icono "CRX-N560" y haga clic en "Permitir".
- 4 Haga clic en "Aceptar" para salir.

Para un PC o NAS con otro software de servidor DLNA instalado

Consulte el manual de instrucciones del dispositivo o software y configure el uso compartido de multimedia.

Reproducción de canciones en el PC

1 Pulse **NET** repetidamente y seleccione [Server].

2 Busque una canción y selecciónela.

▲/▼	Mostrar otra opción.
ENTER	Confirmar la opción seleccionada y pasar al siguiente nivel o iniciar la reproducción.
HOME	Mostrar la opción del nivel superior.
RETURN	Volver a la opción anterior.
NOW PLAYING	Fin de la exploración y visualización de la información de los contenidos reproducidos.

3 Iniciar la reproducción.

▶	Reproducción/pausa
▶▶/◀◀	Pasar a la canción siguiente o anterior de la carpeta.
■	Parada
⌘	Reproducción aleatoria (P.20)
↺	Repetición de reproducción (P.20)

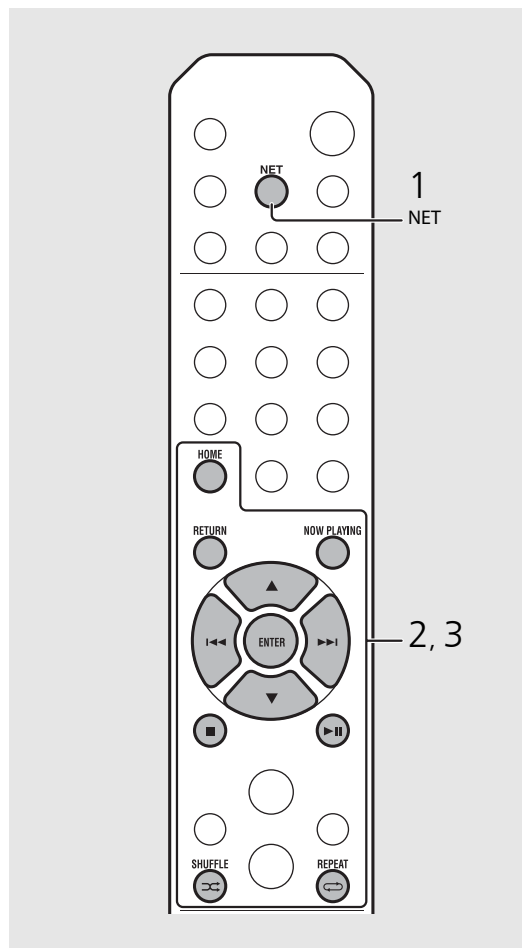

- Si no es posible reproducir, asegúrese de que esta unidad y el PC (servidor) están conectados al mismo router (P.11).

Operaciones desde el dispositivo móvil

Una vez que haya instalado la app "NETWORK PLAYER CONTROLLER" en su dispositivo móvil, podrá controlar la unidad desde el dispositivo móvil.

- Funciones
 - Encendido/apagado, ajuste del volumen y otras operaciones básicas
 - Cambio de la fuente de música
 - Visualización de información del sintonizador de radio
 - Selección, reproducción y parada de canciones
 - Reproducción de canciones almacenadas en los dispositivos

Para descargar la app o la información más reciente, visite el App Store o Google Play y busque "NETWORK PLAYER CONTROLLER".

Escuchar fuentes externas





Esta unidad permite reproducir fuentes externas, como un reproductor de DVD o un reproductor de música portátil. Utilice el terminal (DIGITAL IN 1/2 o AUX 1/2) correcto, en función del dispositivo que vaya a conectar (☞ P.6). Para conectar un dispositivo externo, consulte el manual de instrucciones suministrado con cada dispositivo.

1 Desconecte el cable de alimentación de la unidad y conecte el dispositivo externo a la unidad.

- Prepare los cables (disponibles en el mercado) para la conexión.

2 Vuelva a conectar el cable de alimentación de la unidad a la toma de corriente y pulse  para encender la unidad.

3 Cambie la fuente de música.

- Pulse  o , en función del terminal al que esté conectado el dispositivo externo que desee reproducir.
- Pulse  para cambiar la fuente a AUX1/AUX2 (entrada analógica) o pulse  para cambiar la fuente a DIGITAL IN1/DIGITAL IN2 (entrada digital).

4 Reproduzca el dispositivo externo conectado.

- Para obtener más información sobre la reproducción, consulte el manual de instrucciones suministrado con el dispositivo externo.

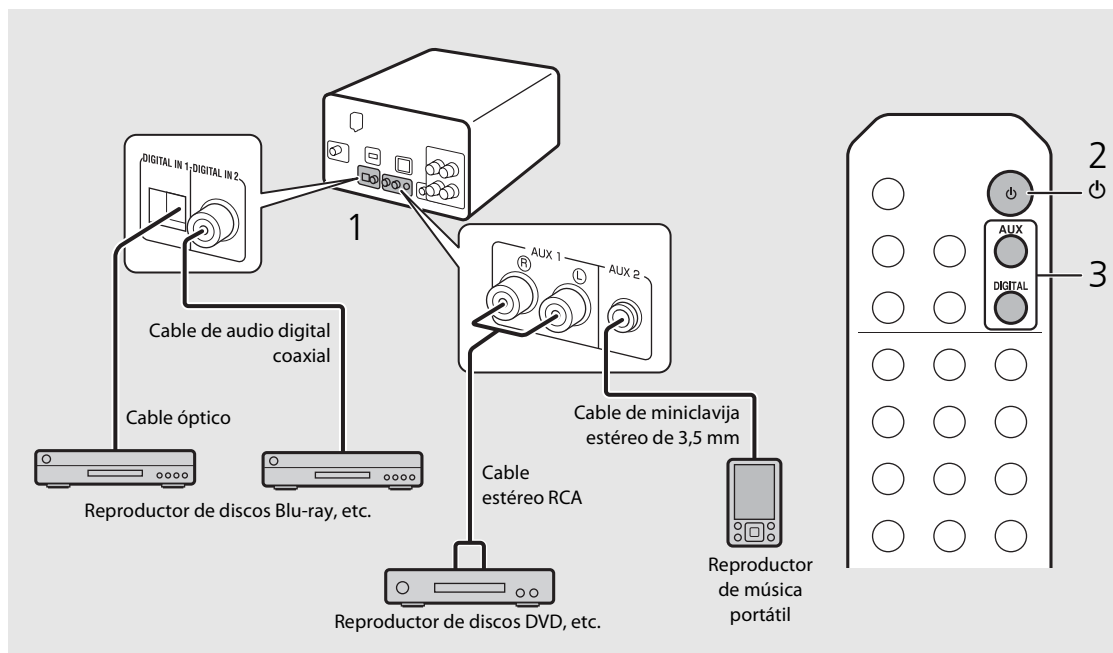

- **Baje el volumen de la unidad y el dispositivo externo antes de la conexión.** De lo contrario, el volumen de la reproducción podría ser excesivo.

Más información sobre la reproducción

Puede disfrutar de las canciones en diferentes órdenes o con diferentes calidades de sonido y ver información sobre la música durante la reproducción. Las operaciones descritas en este apartado son aplicables a todos los dispositivos, como un PC (servidor), un iPod, un dispositivo USB o un CD.

Reproducción aleatoria

Pulse  durante la reproducción.

- El indicador de reproducción aleatoria del visualizador del panel delantero cambia de la forma mostrada a continuación cada vez que pulsa el botón.



 ALL	Iniciar la reproducción aleatoria.*
No mostrado	No inicia la reproducción aleatoria.

* El intervalo de la reproducción aleatoria depende del soporte reproducido.

Reproducción repetida

Pulse  durante la reproducción.

- El indicador de reproducción repetida del visualizador del panel delantero cambia de la forma mostrada a continuación cada vez que pulsa el botón.

 1	Repetir la canción reproducida.
ALL 	Iniciar la repetición de reproducción.*
No mostrado	No inicia la repetición de reproducción.

* El intervalo de la repetición de reproducción depende del soporte reproducido.

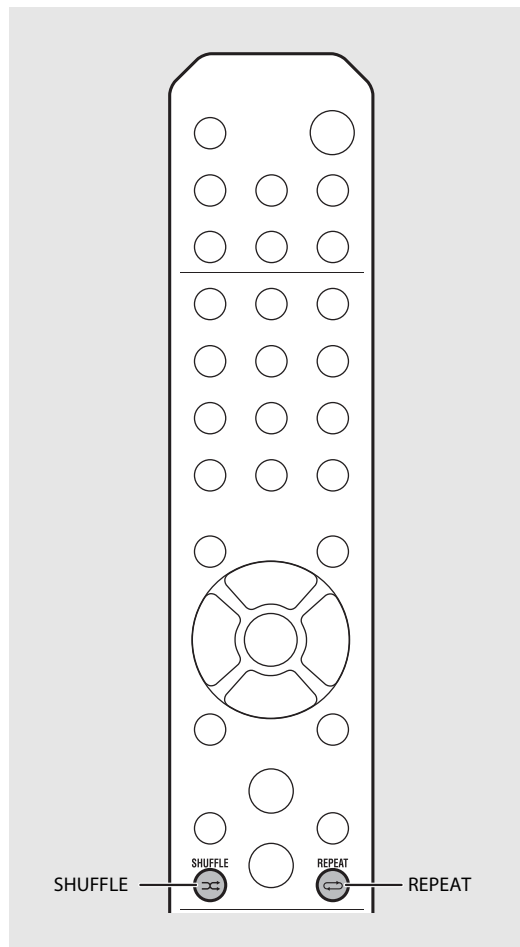

- La reproducción aleatoria y la repetición de reproducción pueden realizarse al mismo tiempo (excepto 1).

Información de reproducción

En el visualizador del panel delantero pueden aparecer el título de la canción o el tiempo transcurrido.

Pulse  durante la reproducción.



- La visualización cambia de la forma mostrada a continuación cada vez que pulsa .

USB/iPod/AirPlay/Server	CD
Título de la canción* ¹	Tiempo de reproducción
Título del álbum	Tiempo restante de la canción* ²
Nombre de artista	Tiempo restante del disco* ²
Tiempo de reproducción	Título de la canción* ^{1, 3}
	Título del álbum* ³
	Nombre del artista* ³

*1 Si no es posible obtener el título de la canción, es posible que aparezca el nombre del archivo.

*2 Solo al reproducir un CD de audio.

*3 Solo al reproducir un CD de audio y si hay información disponible.

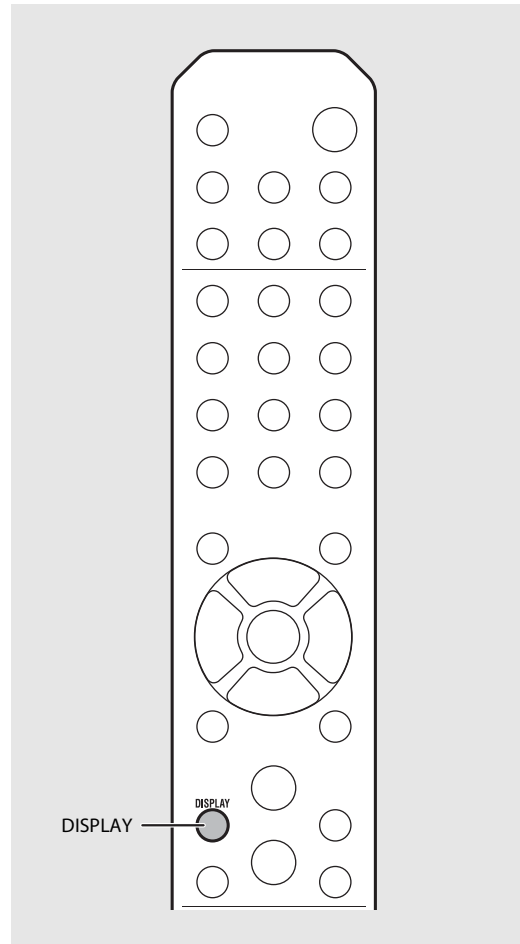

- Los caracteres que aparecen en el visualizador del panel delantero son únicamente alfanuméricos.
- La información no aparece si el iPod está configurado en el modo de visualización estándar (P.16).

Ajuste de la calidad del sonido

Utilice estas opciones para ajustar la calidad del sonido.

- 1 Pulse **OPTION**.
 - Aparece el menú de opciones en el visualizador del panel delantero.
- 2 Pulse **▲/▼** para seleccionar la opción que desee y pulse **ENTER**.
- 3 Pulse **▲/▼** para modificar el valor y pulse **ENTER**.
 - El cambio se aplica.
 - Pulse **RETURN** para volver a la opción anterior.
 - Para cancelar el ajuste de la calidad del sonido, pulse **OPTION**.
 - Para configurar otras opciones, repita los pasos 2 y 3.
- 4 Pulse **OPTION** para finalizar el ajuste.

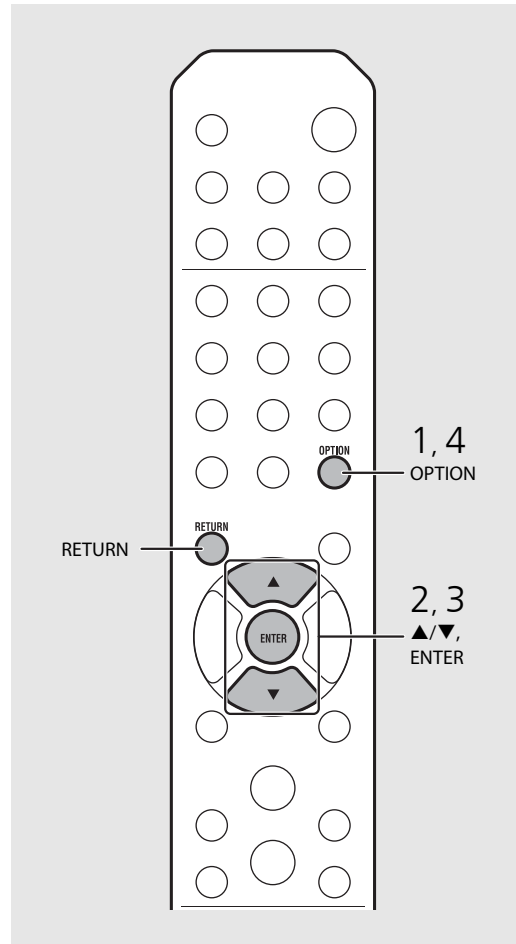

Menú de opciones de calidad de sonido

(Valor de ajuste. **Negrita: predeterminado**)

Equalizer

Ajusta las frecuencias bajas [EQ Low], las frecuencias medias [EQ Mid] y las frecuencias altas [EQ High]. Este ajuste también se aplica cuando se utilizan auriculares. (de -10 a **0** a +10)

Balance

Ajusta el balance del volumen en los altavoces derecho e izquierdo. Este ajuste no se aplica cuando se utilizan auriculares. (de Lch. +10 a **--CENTER--** a Rch. +10)

Music Enhancer

Regenera los elementos musicales perdidos a causa de la compresión. (ON, **OFF**)
Al reproducir fuentes de música de alta calidad, como FLAC o WAV, se recomienda seleccionar [OFF]. Al reproducir un CD de audio sin comprimir, esta función no está disponible aunque se seleccione [ON].

Escuchar emisoras de radio FM

Para escuchar emisoras de radio FM, conecte la antena suministrada.

Consulte "Conexión de la antena" (P.10) para obtener más información sobre cómo conectar la antena a la unidad.

Sintonizar emisoras FM

- 1 Pulse **RADIO**.
- 2 Mantenga pulsado **TUNING** (◀/▶).

 - Empieza la sintonización automática, que se detiene automáticamente cada vez que se sintoniza una emisora.

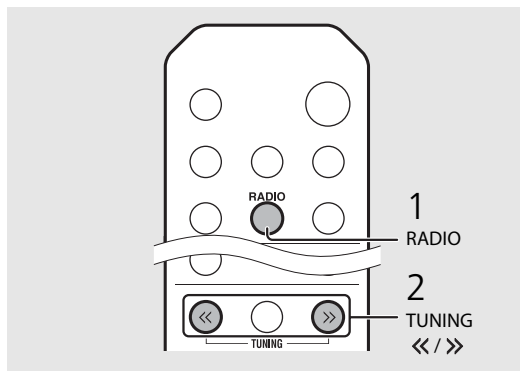

Memorización de emisoras FM

Memorización automática

Sintoniza las emisoras con una buena recepción y las memoriza automáticamente.

- 1 Pulse **RADIO**.
- 2 Mantenga pulsado **MEMORY** durante 2 segundos o más.
- 3 Pulse **MEMORY**.

 - Empieza la memorización automática y, una vez finalizada, aparece "Completed!" en el visualizador del panel delantero.

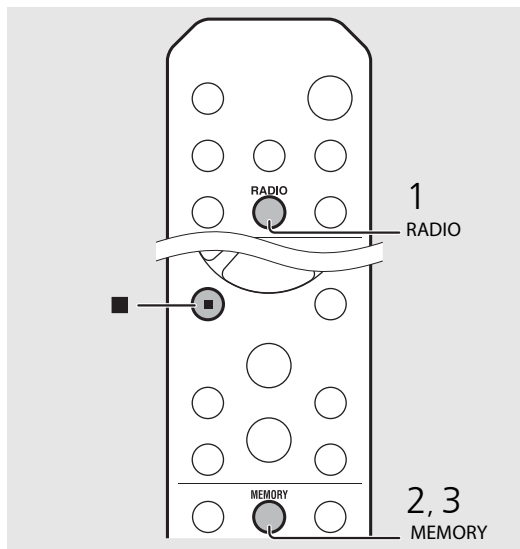

- Si la recepción de la emisora es débil, puede sintonizar una emisora manualmente pulsando el botón **TUNING** (◀/▶) varias veces.



- La memorización automática sustituye todas las emisoras almacenadas previamente por las nuevas emisoras guardadas.



- Es posible presintonizar un máximo de 30 emisoras FM.
- Para cancelar la memorización automática, pulse **■**.

Memorización manual

- 1 Sintonice la emisora que desee almacenar (☞ P.23).
- 2 Pulse .
 - El número de memoria parpadea en el visualizador del panel delantero.



- 3 Pulse ▲/▼ para seleccionar el número de memoria que desee.
- 4 Pulse  para memorizar la emisora.

Selección de emisoras FM memorizadas



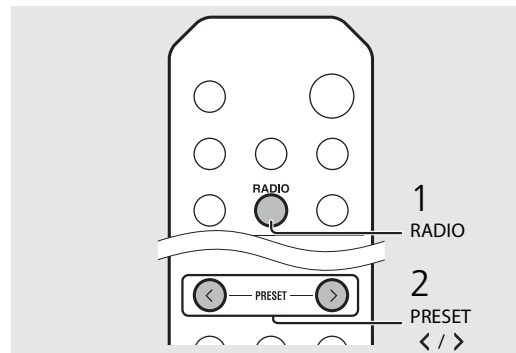
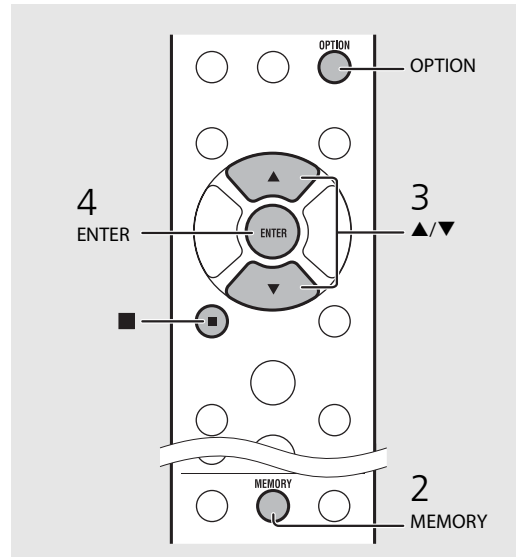

- 1 Pulse .
- 2 Pulse PRESET (◀/▶) para seleccionar una emisora.



- Para cancelar la memorización manual, pulse ■.

Eliminación de una emisora memorizada

Utilice el ajuste de opciones para eliminar una emisora memorizada.

- 1 Pulse  con FM como fuente seleccionada.
 - Aparece el menú de opciones en el visualizador del panel delantero.
 - Para cancelar la eliminación de emisoras memorizadas, pulse .
- 2 Pulse ▲/▼ para seleccionar [Preset Delete] y pulse .
- 3 Pulse ▲/▼ para seleccionar el número de memoria que desee eliminar.
- 4 Pulse .
 - La emisora memorizada se elimina y aparece [Deleted!] en el visualizador del panel delantero.
- 5 Pulse  para finalizar el ajuste.

Escuchar radio por Internet

Ahora, tiene la posibilidad de escuchar emisoras de radio de todo el mundo por Internet. Asegúrese de que la unidad esté correctamente conectada a Internet (☞ P.11).

1 Pulse  repetidamente para seleccionar [Net Radio].

2 Navegue por Internet y seleccione una emisora de radio.



- Las funciones del mando a distancia se detallan a continuación.

▲/▼	Mostrar otra opción.
ENTER	Confirmar la opción seleccionada y pasar al siguiente nivel o iniciar la reproducción.
HOME	Mostrar la opción del nivel superior.
RETURN	Volver a la opción anterior.
NOW PLAYING	Fin de la exploración y visualización de la información de los contenidos reproducidos.

3 Se inicia la reproducción.

- Para detener la reproducción, pulse .

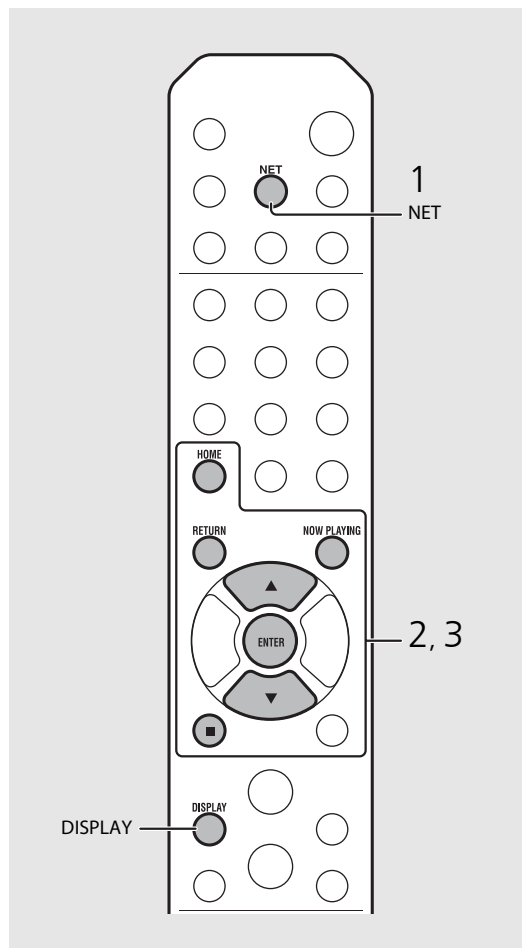

- Puede ver la información de reproducción pulsando el botón **DISPLAY** mientras se reproduce la radio por Internet. Cada vez que pulsa el botón, la información cambia de la forma siguiente.

Nombre de la emisora de radio
(predeterminado)

Título de la canción



Tiempo de reproducción

- Puede registrar sus emisoras de radio por Internet preferidas en la carpeta "Bookmarks" seleccionando [Net Radio] como fuente de entrada en la unidad y, a continuación, accediendo al siguiente sitio web con el navegador de Internet del PC.
<http://radio.vtuner.com/>
Para usar esta función necesita el ID de vTuner de la unidad y su dirección de correo electrónico para crear su cuenta personal. Puede comprobar el ID de vTuner (dirección MAC de la unidad) en [Network Info] (☞ P.32) en el ajuste de opciones.

Escuchar música con AirPlay



La función AirPlay le permite reproducir música de iTunes/iPod de forma inalámbrica en la unidad a través de la red. Asegúrese de que la unidad y el PC o iPod estén correctamente conectados al mismo router (👉 P.11).

Reproducir iPod

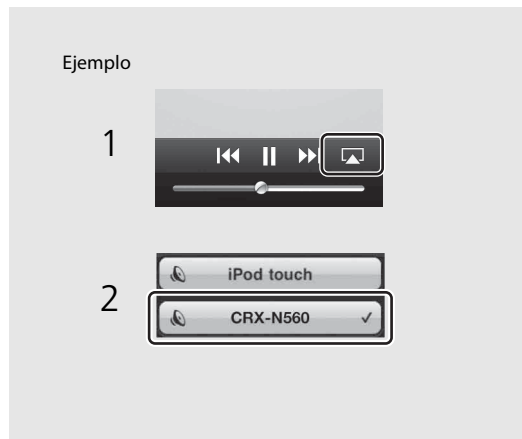
- 1 Encienda la unidad y muestre la pantalla de reproducción en el iPod.
 - Si el iPod reconoce la unidad, aparece  en la pantalla del iPod.
- 2 Toque  y seleccione el nombre de la unidad.
 - La fuente cambia automáticamente a [AirPlay] y empieza la reproducción (excepto en el modo de espera Eco).



Reproducir iTunes

- 1 Encienda la unidad e inicie iTunes.
 - Si iTunes reconoce la unidad, aparece  en la pantalla de iTunes.
- 2 Haga clic en  y seleccione el nombre de la unidad.
 - La fuente cambia automáticamente a [AirPlay] (excepto en el modo de espera Eco).
- 3 Reproduzca las canciones con iTunes.

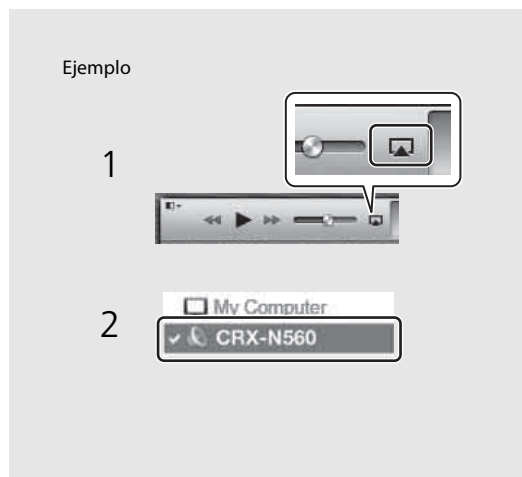

- Cuando se utilizan los controles de iTunes/iPod para ajustar el volumen, el volumen puede estar más alto de lo normal. Esto podría causar daños en la unidad o en los altavoces. Si el volumen aumenta durante la reproducción, detenga inmediatamente la reproducción en el iPod/iTunes.



- También puede utilizar la unidad y el mando a distancia para reproducir, detener o saltar canciones o ponerlas en pausa.
- Para controlar la reproducción de iTunes con el mando a distancia, tiene que configurar las preferencias de iTunes para activar de antemano el control de iTunes desde altavoces remotos.

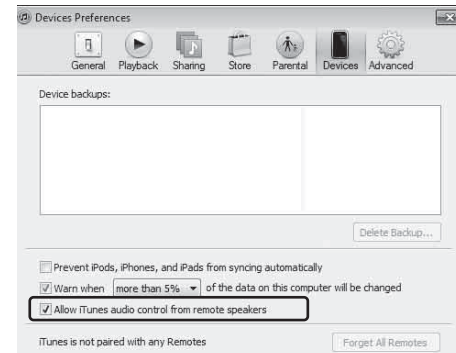

Anulación de AirPlay

- Toque o haga clic en  en la pantalla del iPod/iTunes y seleccione un dispositivo que no sea CRX-N560 en la lista de altavoces. También puede elegir otra fuente que no sea AirPlay.

Utilización del reloj

Una vez configurado el reloj, puede utilizar su canción o programa de radio favorito como alarma.

Ajuste del reloj

1 Pulse .



- Aparece el menú de opciones en el visualizador del panel delantero.

2 Seleccione [System Config] con ▲/▼ y pulse .

3 Seleccione [Clock Setting] con ▲/▼ y pulse .



4 Ajuste la fecha y la hora.

- Modifique los valores con ▲/▼ y pulse  para confirmar.
- Realice la operación empezando por el año y siguiendo por el mes, el día, las horas y los minutos.
- Para cancelar la operación, pulse .
- Una vez finalizado el ajuste, aparece [Completed!].

5 Pulse  para finalizar el ajuste.

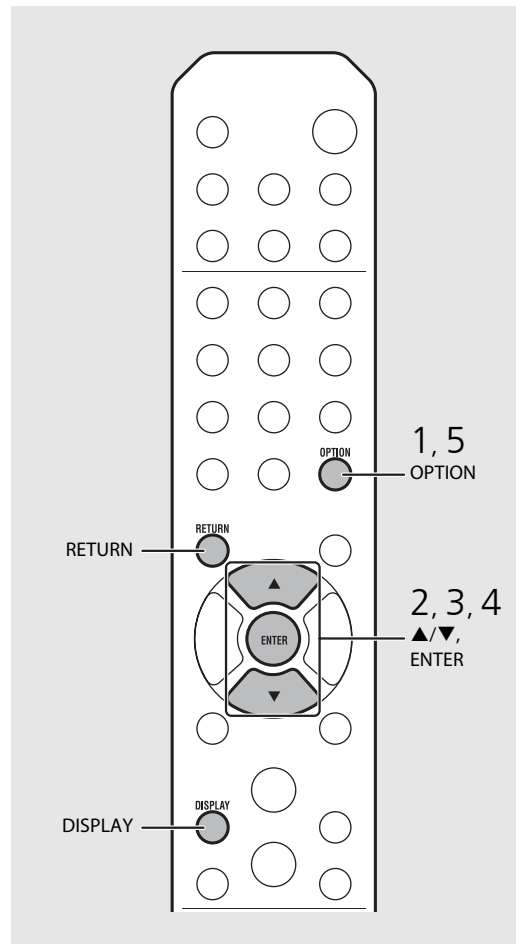

- Los ajustes del reloj se perderán si desconecta el cable de alimentación de la toma de pared durante aproximadamente una semana. Ajuste de nuevo el reloj.



- Puede modificar el formato de la hora (12 horas/ 24 horas) pulsando el botón **DISPLAY** mientras ajusta el reloj.

Ajuste del temporizador de activación



La música o el pitido empezará a sonar a la hora definida.

1 Mantenga pulsado .

- [Timer Setting] y la hora aparecen en el visualizador del panel delantero y  y la hora parpadean.



2 Ajuste las opciones de ① a ③.

- Pulse  para seleccionar un valor de ajuste y pulse  para volver a ajustar la opción.
- Aparece la siguiente opción.
- Para cancelar la operación, pulse .

① Hora de encendido

Ajuste la hora y los minutos.

② Volumen

Puede ajustarse entre [5] y [59] y también [MAX].

③ Repetir

Repeat: El temporizador de activación suena todos los días a la hora definida.

No Repeat: El temporizador de activación suena una vez.

Continúa en la página siguiente ➔

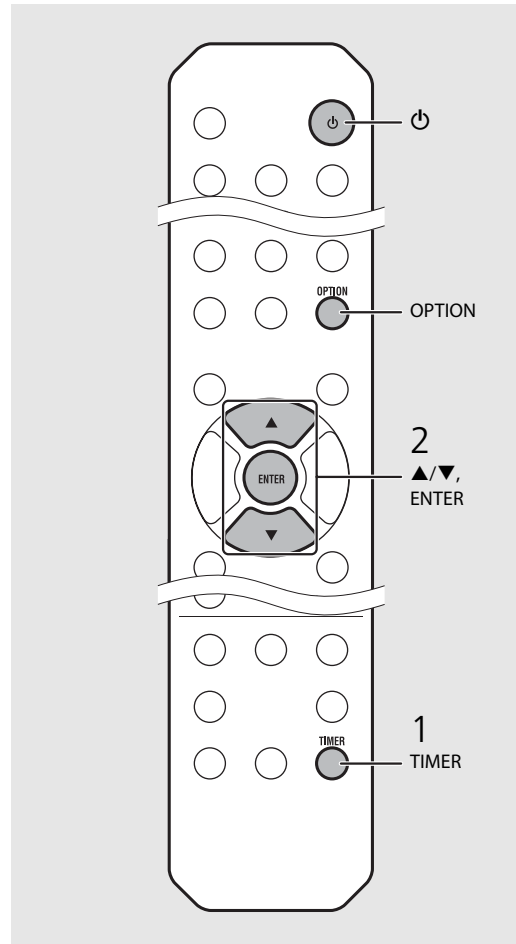

- Antes de configurar el temporizador de activación, ajuste el reloj.
- El temporizador de activación no está disponible si [Power saving] está ajustado en [Eco]. Ajústelo en [Normal] (☞ P.12).



- También puede ajustar el temporizador de activación desde el menú de opciones.

1 Pulse .

- Aparece el menú de configuración en el visualizador del panel delantero.

2 Pulse para seleccionar [Timer Setting] y pulse .

3 Realice el paso 2 de la columna izquierda.

4 Pulse para finalizar el ajuste.

5 Ajuste la fuente de música, reproduzca la fuente y pulse .

- Una vez finalizado el ajuste, aparece [Completed!] y se enciende (●) en el visualizador del panel delantero.



3 Pulse (⏻).

- La unidad entra en el modo de espera y el pitido suena a la hora definida.
- Si desea reproducir música a la hora definida, seleccione una fuente de audio y reproduzca antes de pulsar (⏻) en este paso. Consulte (*), debajo de las sugerencias de la parte derecha, para obtener más información sobre la reproducción de fuentes de audio.

Temporizador de apagado

Puede definir el tiempo que debe transcurrir hasta que la unidad entra automáticamente en el modo de espera.

Pulse ^{SLEEP} (○) varias veces para seleccionar la hora.

- Las opciones de tiempo que puede seleccionar son 30/60/90/120 min. u OFF.
- se enciende poco después de seleccionar la hora y el temporizador de apagado queda configurado.
- Para cancelar el temporizador de apagado, pulse de nuevo ^{SLEEP} (○).

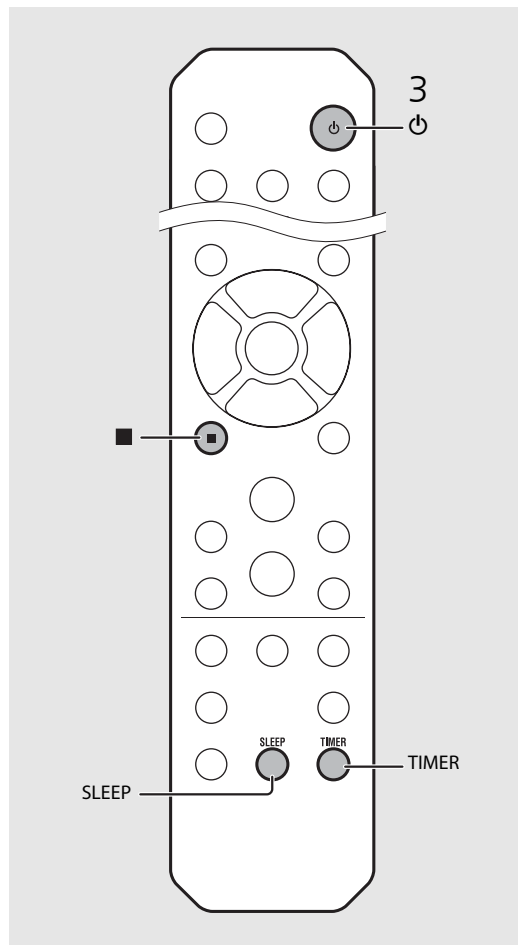

- Si se desconecta la fuente de la unidad después de ajustar el temporizador de activación, la unidad emitirá un pitido a la hora definida para el encendido.
 - Si se está reproduciendo una fuente de música a la hora definida para el encendido, (●) parpadea y la reproducción continúa.
 - Después de ajustar el temporizador de activación, puede activarlo o desactivarlo pulsando el botón **TIMER** con la unidad encendida.
 - Para detener el pitido, pulse o (⏻); de lo contrario, se detendrá en 60 minutos.
- * Si se selecciona AUX, Server, DIGITAL IN o AirPlay como fuente de música, la unidad emite un pitido a la hora definida para el encendido.

Actualización del firmware

Si hay un nuevo firmware disponible, en el visualizador del panel delantero aparecerá un mensaje para actualizar el firmware actual (solo si la unidad está conectada a Internet). En esta página, se describe un procedimiento de actualización a través de la red utilizando el menú de opciones.

1 Pulse .

- Aparece el menú de opciones en el visualizador del panel delantero.

2 Seleccione [System Config] con ▲/▼ y pulse .

3 Seleccione [Firm Update] con ▲/▼ y pulse .

4 Seleccione [Network] con ▲/▼ y pulse .

- Empieza la actualización.



NET UPDATE
S2:Writing 56%

- Una vez finalizada la actualización, aparecen los siguientes mensajes en este orden: "Update success.", "Please..." y "power off!".

5 Desconecte el cable de alimentación de la toma de corriente y vuelva a conectarlo después de aproximadamente 30 segundos.

- La actualización se aplica.

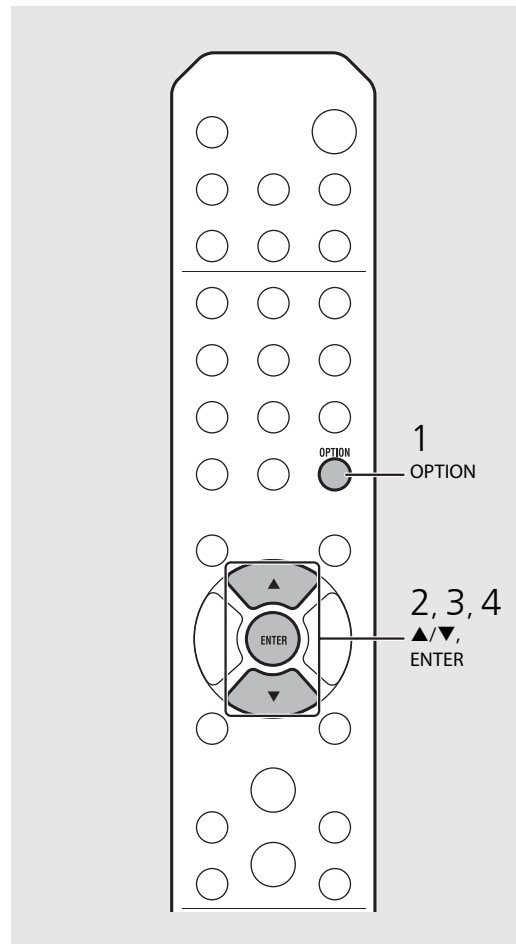

- No controle la unidad ni desconecte el cable de alimentación ni el cable de red durante la actualización.



- Una vez que el mensaje sobre la actualización aparezca en el visualizador del panel delantero, no volverá a aparecer, aunque no realice la actualización. Sin embargo, si enciende la unidad después de haber desconectado el cable de alimentación de la toma de corriente, el mensaje volverá a aparecer.
- Si la conexión a Internet es lenta o si la unidad está conectada a la red inalámbrica por medio de un adaptador de red inalámbrico, es posible que no se pueda realizar la actualización en red, dependiendo del estado de la conexión inalámbrica. En este caso, vuelva a intentarlo o actualice el firmware utilizando un dispositivo de memoria USB. Puede descargar el firmware en el sitio web de Yamaha.

Actualización del firmware a través de un dispositivo de memoria USB

Puede descargar el firmware en la memoria USB y conectar la memoria USB a la toma USB de la unidad.

- Seleccione [USB] en el paso 4 y pulse el botón **ENTER** para iniciar la actualización.

Ajustes de opciones

Los ajustes de opciones permiten configurar la unidad en función de sus preferencias.

1 Pulse .

- Aparece el menú de opciones en el visualizador del panel delantero (ver P.32).

2 Seleccione la opción del menú que desee con ▲/▼ y pulse .





OPTION
Network Config ↕

3 Modifique los ajustes con ▲/▼ y pulse .

- Repita el paso 3 si también tiene que configurar el menú secundario.
- Pulse  para cancelar la operación y volver al nivel anterior.
- Repita los pasos 2 y 3 si tiene que ajustar otra opción del menú.

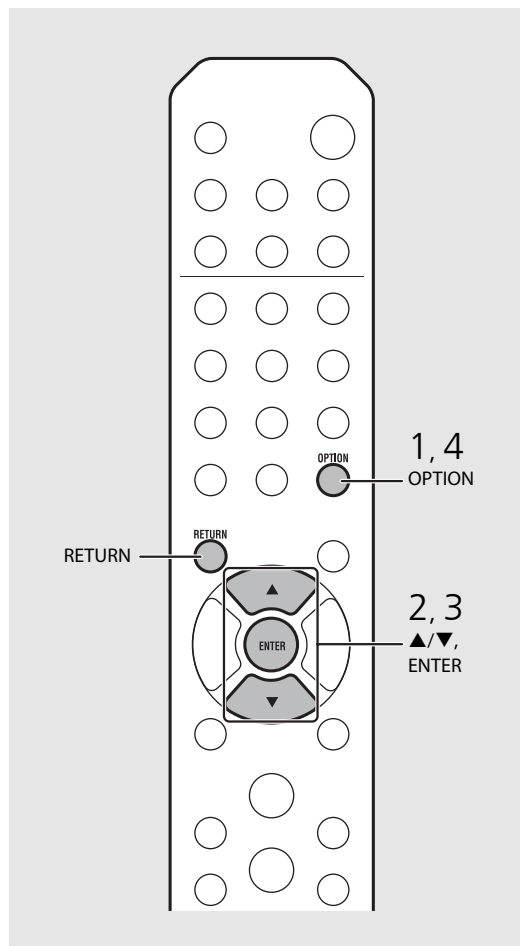
4 Pulse para finalizar el ajuste.



- Para configurar [Advanced Setup] en el menú de opciones, pulse el botón **OPTION** del mando a distancia mientras mantiene pulsado el botón  (parada) de la unidad. A continuación, vaya al paso 3.

Lista de opciones del menú

Menú	Menú secundario	Predeterminado	Función
Preset Delete* ¹ (☞ P.24)			Elimina las emisoras memorizadas.
Equalizer (☞ P.22)	EQ Low	0	Ajusta las frecuencias bajas.
	EQ Mid	0	Ajusta las frecuencias medias.
	EQ High	0	Ajusta las frecuencias altas.
Balance (☞ P.22)		CENTER	Ajusta el balance del volumen en los altavoces derecho e izquierdo.
Music Enhancer (☞ P.22)		OFF	Activa/desactiva Music Enhancer.
Timer Setting (☞ P.28)			Ajusta el temporizador de activación.
Network Info	Network Status		Muestra el estado de conexión de la unidad y la red.
	MAC Address		Muestra la dirección MAC.
	System ID		Muestra el ID del sistema.
	Network Name		Muestra el nombre de la unidad que aparece en la red.

Menú	Menú secundario	Predeterminado	Función
Network Config	DHCP Enabled	YES	Activa/desactiva DHCP.
	IP Address	0.0.0.0	Confirma y ajusta la dirección IP.
	Subnet Mask	0.0.0.0	Confirma y ajusta la máscara de subred.
	Def. Gateway	0.0.0.0	Confirma y ajusta la puerta predeterminada.
	DNS Server(P)	0.0.0.0	Confirma y ajusta el servidor DNS principal.
	DNS Server(S)	0.0.0.0	Confirma y ajusta el servidor DNS secundario.
System Config	Clock Setting		Ajusta el reloj de la unidad (☞ P.27).
	Power Saving	Eco	Ajusta el modo de espera Eco (☞ P.12).
	Auto Power Off	Timer 8H	Ajusta la unidad automáticamente en el modo de espera (☞ P.12).
	Use Accessory	NO	Selecciona si se proporciona alimentación o no a un accesorio Yamaha conectado a través de la toma DC OUT.
	Firm Version		Muestra la versión del firmware de la unidad.
	Firm Update	Network	Actualiza el firmware de la unidad (☞ P.30).

Advanced Setup (☞ P.31)	MAC Add.Filter	OFF	Especifica la dirección MAC (hasta 5) y restringe el acceso de componentes de red a esta unidad. (El funcionamiento con AirPlay no se ve afectado aunque [MAC Add.Filter] esté ajustado en [ON].)
	Factory Reset		Reinicia los ajustes de la unidad a los valores predeterminados de fábrica.

*1 Solo si se reproduce la radio

Resolución de problemas

Consulte la tabla inferior cuando la unidad no funcione correctamente. Si su problema no aparece en la lista a continuación, o si las instrucciones no le sirven de ayuda, apague la unidad, desenchufe el cable de alimentación y póngase en contacto con un centro Yamaha de atención al cliente o concesionario autorizado.

En primer lugar, compruebe que los conectores de cada cable están insertados de forma segura en las tomas de cada dispositivo.

General

Problema	Causa	Solución
La unidad o entra en el modo de espera poco después de conectarse la alimentación. La unidad no funciona correctamente.	El cable de alimentación no está correctamente conectado.	Conecte firmemente el cable de alimentación.
El equipo no se apaga.	El microprocesador interno se ha bloqueado debido a una descarga eléctrica externa (como un rayo o electricidad estática excesiva) o a una caída de la tensión de la fuente de alimentación.	Mantenga pulsado ⏻ en el panel delantero durante más de 10 segundos para reiniciar la unidad. (Si el problema persiste, desconecte el cable de alimentación de la toma de corriente y vuelva a enchufarlo después de como mínimo 30 segundos.)
No hay sonido.	No se ha seleccionado una fuente apropiada.	Seleccione una fuente apropiada con el selector INPUT del panel delantero o los botones de fuente del mando a distancia (⏻ P.5, 8).
	Las conexiones de los altavoces no están seguras.	Asegure las conexiones (⏻ P.9).
	El volumen está al mínimo o silenciado.	Suba el volumen.
La unidad se apaga de forma repentina.	Es posible que esté ajustado el temporizador para dormir (⏻ P.29). Auto Power Off está configurado (⏻ P.12).	Encienda la unidad y reproduzca la fuente de nuevo.
Se ha perdido el ajuste del reloj.	El cable de alimentación se ha desconectado o se ha producido un corte de corriente.	Conecte el cable de alimentación y, a continuación, ajuste el reloj de nuevo (⏻ P.27).
Sólo se oye sonido del altavoz de un lado.	El dispositivo de origen o los altavoces no están conectados correctamente.	Conecte el dispositivo de origen o los cables de los altavoces correctamente (⏻ P.9, 19). Si el problema persiste, los cables podrían estar defectuosos.
Hay interferencia de ruido procedente de un equipo digital o de frecuencias altas.	La unidad está demasiado cerca de un equipo digital o de alta frecuencia.	Separe más la unidad de dicho equipo.
El mando a distancia no está operativo o no funciona bien.	Tal vez se esté utilizando el mando a distancia fuera de la distancia necesaria habitual.	Utilice el mando a distancia dentro del rango operativo (⏻ P.12).
	Puede que el sensor del mando a distancia de esta unidad esté expuesto a la luz solar directa o iluminación, como una lámpara fluorescente de inversor.	Cambie la orientación de la iluminación o la unidad o cambie la unidad de lugar.
	Es posible que la pila esté agotada.	Cambie las pilas por pilas nuevas (⏻ P.4).
	Hay obstáculos entre el sensor de esta unidad y el mando a distancia.	Aparte los obstáculos.

Red

Problema	Causa	Solución
La función de red no funciona.	Los parámetros de red (dirección IP) no se han obtenido correctamente.	Active la función del servidor DHCP en su router y ajuste [DHCP Enabled] del menú [Network Config] en [YES] en la unidad. Si desea configurar los parámetros de red manualmente, compruebe que está utilizando una dirección IP que no esté utilizada por otros dispositivos de su red (☞ P.32).
La reproducción se detiene (no es posible reproducir las canciones de forma continua).	El servidor contiene archivos no compatibles.	Elimine los archivos (incluyendo los archivos de imagen o archivos ocultos) no compatibles con la unidad de la carpeta reproducida.
	El ajuste de compartición de medios no es correcto.	Configure el ajuste de compartición y seleccione la unidad como dispositivo en el que se comparte un contenido musical (☞ P.17).
	Algunos programas de seguridad instalados en el PC bloquean el acceso de la unidad al PC.	Compruebe los ajustes del programa de seguridad instalado en el PC.
La unidad no detecta el PC.	La unidad y el PC no se encuentran en la misma red.	Compruebe las conexiones de red y los ajustes del enrutador y, a continuación, conecte la unidad y el PC a la misma red.
	El filtro de dirección MAC está activado en la unidad.	En [Advanced Setup], en el menú de opciones de la unidad, ajuste [MAC Add.Filter] en [OFF] (☞ P.32).
	Su PC está conectado al SSID secundario de un router compatible con los SSID múltiples.	Si su PC está conectado al SSID secundario, el acceso al dispositivo de conexión con el SSID principal o la LAN está restringido (solo es posible disponer de acceso a Internet). Conecte el PC al SSID principal.
	Hay varios routers conectados entre sus dispositivos de red (router doble).	Desconéctese temporalmente de Internet, compruebe la red local y conecte el dispositivo de red que desea utilizar al mismo router.
	Los archivos del PC no se pueden ver o reproducir.	La unidad o el servidor multimedia no admite los archivos.
Algunos archivos no se pueden reproducir con esta unidad.	Está intentando reproducir archivos con protección DRM (gestión de derechos digitales) adquiridos en iTunes Store.	Los archivos con protección DRM (gestión de derechos digitales) adquiridos en iTunes Store no pueden reproducirse.
La radio de Internet no puede reproducir.	La emisora de radio de Internet seleccionada no está disponible actualmente.	Es posible que haya un problema de red en la emisora de radio o que se haya detenido el servicio. Pruebe la emisora más tarde o seleccione otra emisora.
	La emisora de radio de Internet seleccionada está emitiendo silencio actualmente.	Algunas emisoras de radio de Internet emiten silencio a horas del día concretas. Pruebe la emisora más tarde o seleccione otra emisora.
	El acceso a esta red está restringido por los ajustes de firewall de los dispositivos de red (como, por ejemplo, el enrutador).	Compruebe los ajustes de firewall de los dispositivos de red. La radio de Internet sólo puede reproducir cuando pasa a través del puerto designado por cada emisora de radio. El número del puerto varía según la emisora de radio.

Problema	Causa	Solución
La aplicación específica para dispositivos móviles no detecta la unidad.	El filtro de dirección MAC está activado en la unidad.	En [Advanced Setup], en el menú de opciones de la unidad, ajuste [MAC Add.Filter] en [OFF] o especifique la dirección MAC de sus dispositivos móviles para permitir el acceso a la unidad (☞ P.32).
	La unidad y los dispositivos móviles no se encuentran en la misma red.	Compruebe las conexiones de red y los ajustes del router y, a continuación, conecte la unidad y el dispositivo móvil a la misma red.
	Su dispositivo móvil está conectado al SSID secundario de un router compatible con los SSID múltiples.	Si su dispositivo móvil está conectado al SSID secundario, el acceso al dispositivo de conexión con el SSID principal o la LAN está restringido (solo es posible disponer de acceso a Internet). Conecte el dispositivo móvil al SSID principal.
	Hay varios routers conectados entre sus dispositivos de red (router doble).	Desconéctese temporalmente de Internet, compruebe la red local y conecte el dispositivo de red que desea utilizar al mismo router.
La actualización del firmware a través de la red no ha podido realizarse.	La conexión de red es inestable.	Intente de nuevo la actualización dentro de un rato. También puede actualizar el firmware a través de una memoria USB (☞ P.30).



iPod

Problema	Causa	Solución
No hay sonido.	El iPod no está conectado correctamente.	Vuelva a conectar el iPod a la toma USB (☞ P.15).
	La versión de software del iPod no está actualizada.	Descargue la última versión de iTunes desde el sitio web de Apple para actualizar la versión del software del iPod.
	El iPod está en proceso de conexión con la unidad.	Espere un momento.
	El iPod no es compatible con esta unidad.	Utilice un modelo de iPod compatible (☞ P.39).
El iPod no puede controlarse desde el iPod, la unidad o el mando a distancia.	El iPod no está conectado correctamente.	Vuelva a conectar el iPod a la toma USB (☞ P.15).
	La versión de software del iPod no está actualizada.	Descargue la última versión de iTunes desde el sitio web de Apple para actualizar la versión del software del iPod. Si no es posible resolver el problema, ni siquiera con el software más reciente, restablezca el iPod.
	Si el iPod está configurado con el modo de visualización estándar, el iPod no puede controlarse desde la unidad ni el mando a distancia. Si está en el modo ampliado, el iPod no puede utilizarse para controlar sus funciones.	Compruebe el modo de visualización (☞ P.16).
La información de reproducción no aparece en el visualizador del panel delantero.	El iPod no permite la visualización de información de reproducción.	Esta función solo está disponible con un iPod compatible con esta unidad (☞ P.39).
	El modo de visualización configurado es el modo estándar.	Seleccione el modo de visualización ampliado (☞ P.16).

Resolución de problemas

Problema	Causa	Solución
El iPod no se carga.	El iPod no está conectado correctamente.	Vuelva a conectar el iPod a la toma USB (☞ P.15).
	El iPod no es compatible con esta unidad.	Utilice un modelo de iPod compatible (☞ P.39).
	La unidad está en el modo de espera Eco.	Ajuste [Power Saving] en [Normal] en los ajustes de opciones (☞ P.12).

Disco

Problema	Causa	Solución
La reproducción no se inicia después de insertar un disco. Algunas operaciones con botones no funcionan.	El disco introducido en la unidad podría no ser compatible.	Utilice un disco compatible con la unidad (☞ P.39).
La reproducción no comienza inmediatamente después de pulsar  /  en la unidad o  en el mando a distancia (se detiene inmediatamente).	El disco podría estar sucio.	Limpie el disco (☞ P.39).
	El disco introducido en la unidad podría no ser compatible.	Utilice un disco compatible con la unidad (☞ P.39).
	Si la unidad se ha trasladado desde un lugar frío hasta un lugar cálido, podría haberse formado condensación en la lente de lectura de disco.	Espere una hora o dos, hasta que la unidad se ajuste a la temperatura de la habitación, e inténtelo de nuevo.

Dispositivos USB

Problema	Causa	Solución
La unidad no detecta el dispositivo USB.	El dispositivo USB no está conectado con seguridad a la toma USB.	Apague la unidad, vuelva a conectar el dispositivo USB y vuelva a encender la unidad (☞ P.15).
	El sistema de archivos del sistema USB no es FAT16 o FAT32.	Utilice un dispositivo USB con formato FAT16 o FAT32.
No se pueden ver las carpetas y archivos del dispositivo USB.	Los datos del dispositivo USB están protegidos por el cifrado.	Utilice un dispositivo USB sin función de cifrado.

Recepción FM

Problema	Causa	Solución
La recepción estéreo por FM tiene ruido.	La antena no está conectada correctamente.	Asegúrese de que la antena está conectada correctamente y cambie la posición de la antena (☞ P.10).
	Es posible que la emisora de radio seleccionada esté lejos de su zona o que la recepción de la antena no funcione correctamente.	Utilice una antena para exteriores disponible en el mercado. Para obtener más información, consulte con un establecimiento especializado.
La sintonización automática no funciona.	Es posible que la emisora de radio seleccionada esté lejos de su zona o que la recepción de la antena no funcione correctamente.	Utilice una antena para exteriores disponible en el mercado. Para obtener más información, consulte con un establecimiento especializado.
		Utilice el método de sintonización manual (☞ P.23).
No es posible seleccionar una emisora de radio memorizada.	Es posible que se haya borrado la presintonía (memoria).	Memorice las emisoras de radio de nuevo (☞ P.23, 24).
Hay distorsión y no se puede obtener una buena recepción a pesar de utilizar una buena antena de FM o una antena exterior.	Es posible que se esté produciendo reflexión multirruta o algún otro tipo de interferencia de radio.	Cambie la altura, la dirección o la posición de la antena.

Mensajes del visualizador del panel delantero

Mensaje	Causa	Solución
Unknown	Hay un problema con la trayectoria de señal de su iPod a esta unidad.	Vuelva a conectar el iPod.
	El iPod/dispositivo USB conectado no es compatible con la unidad.	Utilice un modelo de iPod/dispositivo USB compatible (🔗 P.39).
	El software del iPod no se ha actualizado.	Descargue la última versión de iTunes desde el sitio web de Apple para actualizar la versión del software del iPod.
Timer not work	La unidad está en el modo de espera Eco.	Ajuste [Power Saving] en [Normal] en los ajustes de opciones (🔗 P.12).
Overcurrent	El iPod/dispositivo USB conectado no es compatible con la unidad.	Desconecte el iPod/dispositivo USB, apague la unidad y vuelva a encenderla. Si esta solución no resuelve el problema en el caso del dispositivo USB, significa que no puede reproducirse en la unidad.
	El iPod/dispositivo USB no está conectado correctamente.	
Unplugged	El iPod/dispositivo USB no está conectado de forma segura.	Desconecte el iPod/dispositivo USB y vuelva a conectarlo (🔗 P.15).
No Disc	El disco introducido en la unidad podría no ser compatible con la unidad.	Utilice un disco compatible con la unidad (🔗 P.39).
	Es posible que el disco esté sucio o que tenga elementos adheridos.	Extraiga el disco y límpielo.
	El disco está introducido al revés.	Coloque el disco con la cara de la etiqueta hacia arriba.
No Songs	El disco no contiene archivos reproducibles.	Introduzca un disco con archivos reproducibles (🔗 P.39).
Initializing	La unidad se está activando.	Espere hasta que desaparezca el mensaje. Si el mensaje se mantiene durante más de 3 minutos, apague la unidad y vuelva a encenderla.
Loading...	La unidad está cargando el archivo o los contenidos especificados.	Espere hasta que termine la carga de la unidad.
No Content	La carpeta seleccionada no contiene archivos reproducibles.	Seleccione una carpeta con archivos reproducibles (🔗 P.40).
Not Connected	La unidad no está conectada a Internet.	Verifique la conexión a Internet.
Unsupported	Está tratando de reproducir un archivo no compatible con la unidad.	Reproduzca un archivo compatible con la unidad (🔗 P.40).
No Operation	Está tratando de abrir la bandeja del disco mientras configura el menú de opciones.	Abra la bandeja del disco después de configurar las opciones.
Access Denied	El acceso al PC se ha denegado.	Configure los ajustes de compartición y seleccione la unidad como dispositivo en el que se comparte un contenido musical (🔗 P.17).
Access Error	La unidad no puede acceder al dispositivo USB.	Apague la unidad y vuelva a conectar el dispositivo USB. Si el problema persiste, pruebe con otro dispositivo USB.
	La unidad no puede acceder al iPod.	Apague el iPod y vuelva a encenderlo.
	El iPod conectado no es compatible con la unidad.	Utilice un iPod compatible con la unidad (🔗 P.39).
Version Error	Hay un problema con la trayectoria de la señal desde la red hasta la unidad.	Asegúrese de que el enrutador y el módem estén encendidos. Compruebe la conexión entre la unidad y el enrutador (o nodo) (🔗 P.11).
	La actualización del firmware ha fallado.	Actualice el firmware de nuevo.

Dispositivos, soportes y formatos de archivo compatibles

Dispositivos y soportes compatibles

PC

PC con Reproductor de Windows Media 11 o Reproductor de Windows Media 12 instalado.

NAS

NAS compatible con la versión 1.5 de DLNA.

Dispositivos USB

- Esta unidad es compatible con dispositivos de clase de almacenamiento masivo USB (por ejemplo, memorias flash o reproductores de audio portátil) que utilicen el formato FAT16 o FAT32.
- No conecte dispositivos que no sean dispositivos de almacenamiento masivo USB (como por ejemplo, cargadores de USB o concentradores de USB), PC, lectores de tarjetas, una unidad de disco duro externo, etc.
- No es posible utilizar dispositivos USB con cifrado.

iPod

iPod	iPod touch (1ª, 2ª, 3ª, 4ª y 5ª generaciones), iPod nano (2ª, 3ª, 4ª, 5ª, 6ª y 7ª generaciones)
iPhone	iPhone 5, iPhone 4S, iPhone 4, iPhone 3GS, iPhone 3G, iPhone
iPad	iPad (4ª generación), iPad mini, iPad (3ª generación), iPad 2, iPad

(Información actualizada a agosto de 2013)

Nota

La licencia concedida para la utilización de iPod establece que los usuarios solo pueden copiar y reproducir para su uso privado material sin derechos de autor o material con autorización legal para la copia y la reproducción. La vulneración de los derechos de propiedad intelectual está sancionada por la ley.

Discos

- Esta unidad está diseñada para utilizarse con CD de audio, CD-R/RW (formato ISO 9660) con cualquiera de los siguientes logotipos impresos en el disco o en la caja del disco.

CD de audio



CD-R/RW*



* Discos con alguna de las siguientes inscripciones:
FOR CONSUMER
FOR CONSUMER USE
FOR MUSIC USE ONLY

- Esta unidad puede reproducir discos de 8 cm. Coloque el disco en la zona interior cóncava de la bandeja del disco.

Notas acerca de los discos

- No introduzca discos de características diferentes de las descritas anteriormente en la unidad. De lo contrario, podría dañar la unidad.
- Los discos CD-R/RW no pueden reproducirse si no están finalizados.
- En función de las características del disco o las condiciones de grabación, algunos discos no pueden reproducirse.

- No utilice discos de formas no convencionales, como por ejemplo en forma de corazón.
- No utilice discos con muchos arañazos o con grietas en su superficie o bien discos deformados o con adhesivo.

Manipulación de los discos

- No toque la superficie del disco y sujételo siempre por su borde o por el orificio del centro.
- Utilice un rotulador de punta suave cuando escriba en la cara etiquetada de un disco.
- No aplique cinta adhesiva, cola ni material sellante a un disco.
- No utilice fundas de protección para evitar los arañazos.
- No introduzca objetos extraños en la bandeja del disco.
- No cargue más de un disco en la unidad al mismo tiempo. De lo contrario, podría provocar daños en la unidad y en los discos.
- Si un disco se ensucia, límpielo con un paño limpio y seco, desde el centro hacia los bordes. No utilice limpiadores de discos ni disolventes.
- No utilice limpiadores de lentes, porque pueden provocar fallos de funcionamiento.
- No exponga los discos a la luz solar directa, alta temperatura, niveles altos de humedad ni polvo.
- Si un disco no se utiliza, sáquelo de la unidad y guárdelo en su caja.

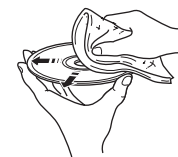

Formatos de archivo

La unidad es compatible con los siguientes formatos de archivo.

DLNA/USB

- La unidad admite la reproducción de archivos WAV (solo formato PCM), MP3, WMA, MPEG-4 AAC y FLAC (únicamente audio de 1 o 2 canales).
- La unidad es compatible con unas frecuencias de muestreo de hasta 192 kHz para los archivos WAV y FLAC, de 48 kHz para los demás archivos.
- Para reproducir archivos FLAC, es necesario instalar en el PC software de servidor que admita el uso compartido de archivos FLAC a través de DLNA o usar una NAS compatible con archivos FLAC.
- No se puede reproducir contenido con gestión de derechos digitales (DRM).

Discos

- La unidad admite la reproducción de archivos MP3 y WMA con una frecuencia de muestreo de hasta 48 kHz.
- La unidad es compatible con velocidades de bits constantes y variables de entre 8 y 320 kbps en el caso de archivos MP3 y entre 16 y 320 kbps en el caso de archivos WMA.
- Esta unidad puede reproducir como máximo 512 archivos y 255 carpetas (como máximo 511 archivos por carpeta).
- No es posible reproducir archivos con gestión de derechos digitales (DRM).



AirPlay es compatible con iPhone, iPad y iPod touch con iOS 4.3.3 o posterior, Mac con OS X Mountain Lion y Mac y PC con iTunes 10.2.2 o posterior.

“Made for iPod” (Fabricado para iPod), “Made for iPhone” (Fabricado para iPhone) y “Made for iPad” (Fabricado para iPad) significa que un accesorio electrónico se ha diseñado específicamente para conectarse a un iPod, un iPhone o un iPad, respectivamente y que el desarrollador ha certificado que cumple con los estándares de rendimiento de Apple. Apple no se hace responsable del funcionamiento de este dispositivo ni de su cumplimiento con los estándares normativos y de seguridad.

Tenga en cuenta que el uso de este accesorio con un iPod, un iPhone o un iPad puede afectar al rendimiento inalámbrico.

AirPlay, iPad, iPhone, iPod, iPod nano, iPod touch y iTunes son marcas comerciales de Apple Inc., registradas en los EE. UU. y en otros países.



Fraunhofer Institut Integrierte Schaltungen

Tecnología de codificación de audio MPEG Layer-3 con licencia de Fraunhofer IIS and Thomson.



Esta unidad es compatible con las conexiones de red.



DLNA™ y DLNA CERTIFIED™ son marcas comerciales o marcas comerciales registradas de Digital Living Network Alliance. Todos los derechos reservados. El uso no autorizado está estrictamente prohibido.

Windows™

Windows es una marca comercial registrada de Microsoft Corporation en los EE. UU. y en otros países.

Internet Explorer, Windows Media Audio y Reproductor de Windows Media son marcas registradas o marcas comerciales de Microsoft Corporation en Estados Unidos y/ o en otros países.

Android™

Android y Google Play son marcas comerciales de Google, Inc.

Especificaciones

Sección del reproductor

CD	Soportes		CD, CD-R/RW
	Formato de audio		CD de audio, MP3, WMA
	Láser	Tipo	Láser semiconductor GaAs/GaAlAs
		Longitud de onda	790 nm
Potencia de salida		10 mW	
iPod (conexión digital)	iPod compatibles		Consulte la página 39.
	iPhone compatibles		
	iPad compatibles		
USB	Formatos de archivo compatibles		MP3, WMA, MPEG4 AAC, WAV*, FLAC* * Hasta 192 kHz/24 bits
AUX IN	Conector de entrada	AUX1	Estéreo izq./der.: RCA
		AUX2	Minitoma estéreo de 3,5 mm
DIGITAL IN	Conector de entrada	DIGITAL IN 1	Óptica
		DIGITAL IN 2	Coaxial
Red	Interfaz		100Base-TX/10Base-T
	Radio de Internet		Compatible con el servicio vTuner
	Función PC cliente		Compatible con DLNA, ver. 1.5 (función DMP/DMR)
	Formatos de archivo compatibles		MP3, WMA, MPEG4 AAC, WAV*, FLAC* * Hasta 192 kHz/24 bits
	AirPlay		Compatible con AirPlay

Sección del sintonizador

Rango de sintonización (FM)	De 87,50 a 108,00 MHz
-----------------------------	-----------------------

Sección del amplificador

Potencia de salida máxima	32 W + 32 W (6 Ω 1 kHz, 10% THD)
Distorsión armónica total AUX1 1 kHz/12,5 W	0,05% o menos
Control de ecualizador	EQ High (agudos)/EQ Mid (medios)/EQ Low (graves): ±10 dB
Auriculares	Estéreo izq./der.: minitoma estéreo de 3,5 mm Impedancia adaptada: 16 Ω - 32 Ω

General

Alimentación eléctrica	Modelo para Asia	CA 220-240 V, 50/60 Hz
	Modelo para Taiwán	CA 110-120 V, 60 Hz
	Modelo para China	CA 220 V, 50 Hz
	Modelo para Corea	CA 220 V, 60 Hz
Consumo		44 W
Consumo en el modo de espera		6 W o menos
Consumo en el modo de espera Eco		0,5 W o menos
Dimensiones (Anchura × Altura × Profundidad)		215 × 110 × 288 mm
Peso		2,7 kg

(Información actualizada a agosto de 2013)
Las especificaciones están sujetas a cambios sin previo aviso.

目录

简介4

- 随机配件4
- 关于本说明书4

部件名称5

- 前面板5
- 后面板6
- 前面板显示屏7
-  调节显示屏亮度7
- 遥控器8

准备工作9

- 连接音箱9
- 连接天线10
- 连接至网络11
- 打开电源12

设定网络装置13

- PC.....13
- NAS.....13
- 移动装置13

聆听 CD14

聆听 iPod/USB 装置中的音频15

- 播放 iPod.....15
- 播放 USB 装置15

聆听电脑中的歌曲17

- 设定音乐文件媒体共享17
- 播放 PC 中的歌曲18

聆听外部音频源19

关于播放的更多信息20

- 随机播放20
- 重复播放20
- 播放信息21
- 调节音质22

收听 FM 电台23

- FM 电台调谐23
- 预设 FM 电台23
- 选择预设的 FM 电台24
-  删除预设电台24

收听网络电台25

使用 AirPlay 听音乐26

- 播放 iPod.....26
- 播放 iTunes.....26

使用时钟27

- 设定时钟27
- 设定闹铃定时器28
- 睡眠定时器29

更新固件30

选项设置31

- 选项菜单列表32

故障排除33

- 一般33
- 网络34
- iPod.....35
- 光盘36
- USB 装置36
- FM 接收37
- 前面板显示屏上的信息38

支持的装置 / 媒体和文件格式39

规格41

软件信息i



太棒了！ 非常出色的音质！

从 PC 播放的声音非常
不错！17, 18

播放高分辨率声音22

随时随地 享受音乐！

便捷的应用程序！把智能手机当作遥
控器18

通过音箱无线播放 iPhone
中的歌曲。26

关于音乐的 更多信息

可以连接多种外部装置（蓝光 /
DVD/ 移动音频播放器等） 19

可以通过音频系统收听网络
电台 25

简介

确认包装清单及本手册的有用要点。

随机配件

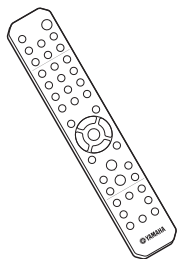

遥控器

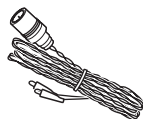

FM 天线

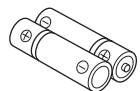

电池 (× 2)
(AA, R6, UM-3)

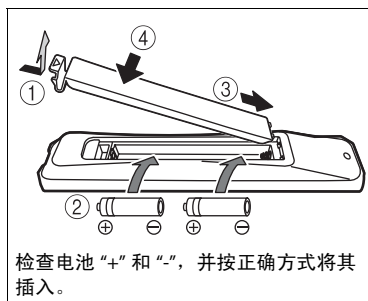

关于本说明书

- 本机的操作方法主要针对遥控器进行描述。
- 图示可能与实际描述的对象有所不同。
- 本手册中描述的“iPod”也可能指的是“iPhone”或“iPad”。

• 符号：



表示与本机的使用及其功能限制有关的注意事项。



表示为方便使用而提供的补充说明。



表示相应的参考页。



- 当遥控器的操作范围缩小时，请同时更换 2 节电池。

部件名称

熟悉所有部件和这些功能。

前面板

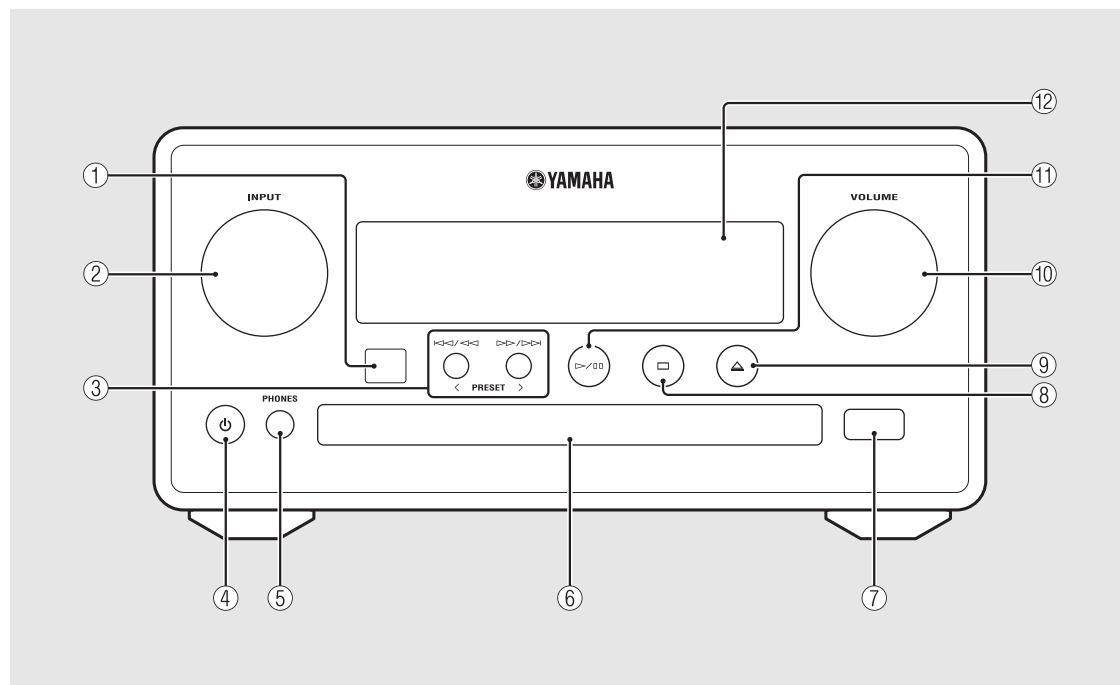

- ① 遥控器接收器
- ② INPUT
向左或向右转动可改变音频源。(音频源显示在前面板显示屏上。)
- ③ ⏮/⏭ ⏮/⏭ (☞ 第 14、16、18 页)
PRESET </> (☞ 第 24 页)
- ④ ⏻ (电源) (☞ 第 12 页)
- ⑤ PHONES
将耳机连接至此插孔。
- ⑥ 光盘托盘 (☞ 第 14 页)
- ⑦ USB 插孔 (☞ 第 15 页)
- ⑧ ⏹ (停止) (☞ 第 14、16、18、25 页)
- ⑨ ⏮/⏭ (打开 / 关闭光盘托盘) (☞ 第 14 页)
- ⑩ VOLUME
控制音量。
- ⑪ ⏮/⏭ (播放 / 暂停) (☞ 第 14、16、18 页)
- ⑫ 前面板显示屏 (☞ 第 7 页)

后面板

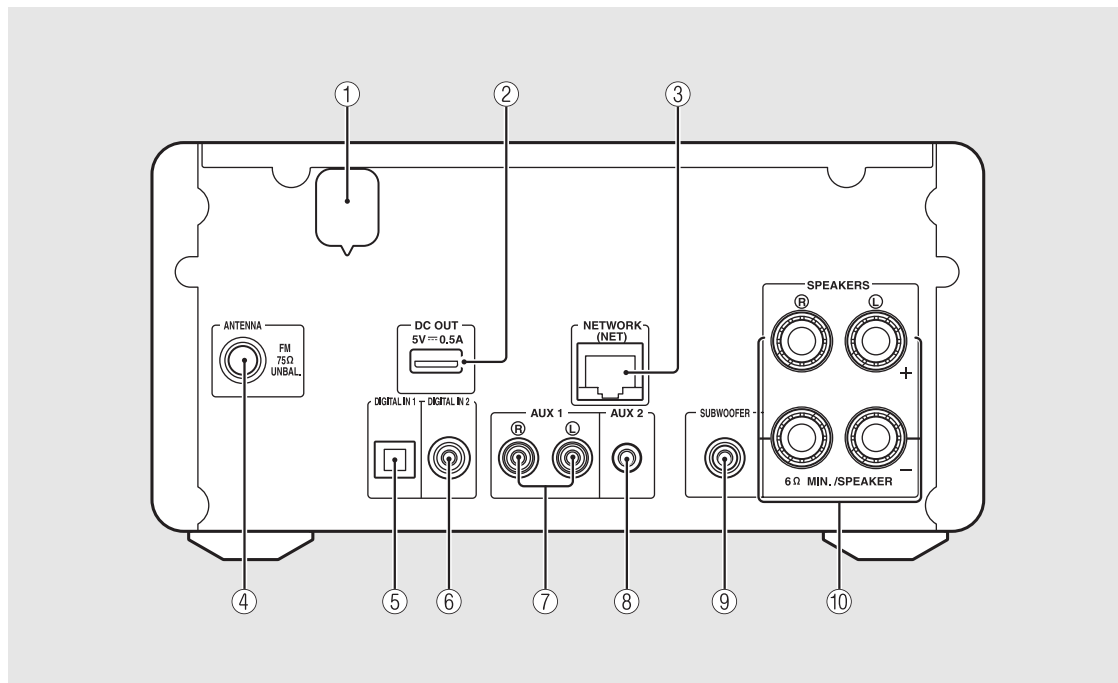

① 电源线 (☞ 第 12 页)

② DC OUT 端子

通过此端子为 Yamaha AV 配件供电。在使用时，从选项设置的 [System Config] 中将 [Use Accessory] 设定为 [YES] (☞ 第 31 页)。有关详情，请参阅配件附带的使用说明书。

③ NETWORK 端子 (☞ 第 11 页)

使用市售网线连接至网络。

④ FM 天线端子 (☞ 第 10 页)

⑤ DIGITAL IN 1 端子 (光纤输入) (☞ 第 19 页)

⑥ DIGITAL IN 2 端子 (同轴输入) (☞ 第 19 页)

⑦ AUX 1 端子 (RCA 输入) (☞ 第 19 页)

⑧ AUX 2 端子 (迷你插孔输入) (☞ 第 19 页)

⑨ SUBWOOFER 端子 (☞ 第 9 页)

⑩ SPEAKERS 端子 (☞ 第 9 页)

前面板显示屏

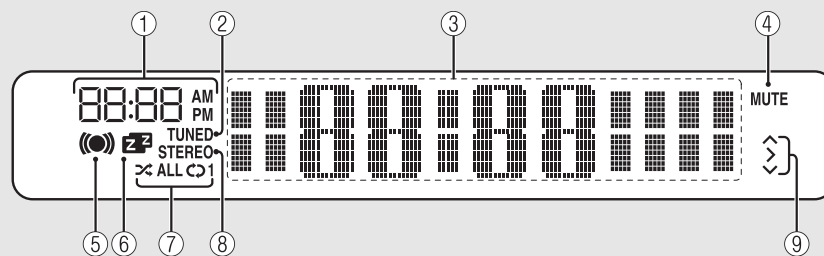

① 时钟

当电源开启时显示时间。

② TUNED 指示

当本机调入电台时点亮。

③ 多信息显示

显示各种信息，如待机模式下的时钟，音乐信息或者无线电频率（仅字母数字）。

④ MUTE 指示

当静音时点亮（☞第 8 页）。

⑤ 闹铃定时器指示

在设定闹铃定时器期间闪烁，当设定了定时器时点亮（☞第 28 页）。

⑥ 睡眠定时器指示

当设定了睡眠定时器时点亮（☞第 29 页）。

⑦ 随机 / 重复指示

当您 iPod、CD、USB 装置或电脑设定为随机或重复播放时点亮（☞第 20 页）。

⑧ STEREO 指示

当本机正在接收 FM 立体声广播较强信号时点亮。

⑨ 操作指示

显示遥控器上可用的控制按钮 ▲/▼/ENTER（☞第 8 页）。



调节显示屏亮度

按遥控器上的 **DIMMER** 按钮可调节前面板显示屏的亮度（☞第 8 页）。

- 每按一下按钮就会改变亮度：亮（默认）、中等或暗。

遥控器

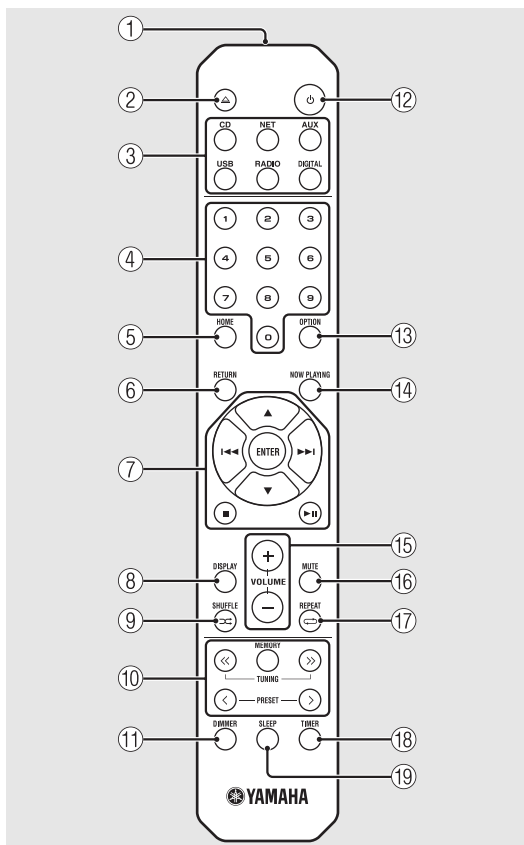

- ① 红外线信号发射器
- ② \triangle (打开/关闭光盘托盘) (☞ 第 14 页)
- ③ 音频源按钮
切换要播放的音频源。
- ④ 数字按钮 (☞ 第 14 页)
- ⑤ HOME (☞ 第 16、18、25 页)
- ⑥ RETURN (☞ 第 14、16、18、25 页)
- ⑦ 音频控制、光标控制按钮
(☞ 第 14、16、18、25 页)
- ⑧ DISPLAY (☞ 第 21 页)
- ⑨ \rightleftarrows (SHUFFLE) (☞ 第 20 页)
- ⑩ FM 控制按钮 (☞ 第 23、24 页)
- ⑪ DIMMER (☞ 第 7 页)
- ⑫ ϕ (电源) (☞ 第 12 页)
- ⑬ OPTION (☞ 第 22、27、31 页)
- ⑭ NOW PLAYING (☞ 第 16、18、25 页)
- ⑮ VOLUME +/-
控制音量。
- ⑯ MUTE
开启或关闭静音。
- ⑰ \rightleftarrows (REPEAT) (☞ 第 20 页)
- ⑱ TIMER (☞ 第 28 页)
- ⑲ SLEEP (☞ 第 29 页)

准备工作

连接音箱或天线，并打开本机。

在连接好所有缆线之前，请勿连接本机的电源线。

连接音箱

- 1 撕下音箱缆线端的绝缘层，露出裸线。

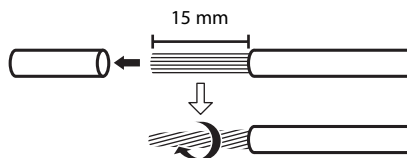

- 2 按照图示，将音箱连接至本机。

- 分别准备音箱或音箱缆线。
- 关于连接音箱，请参阅音箱附带的使用说明书。

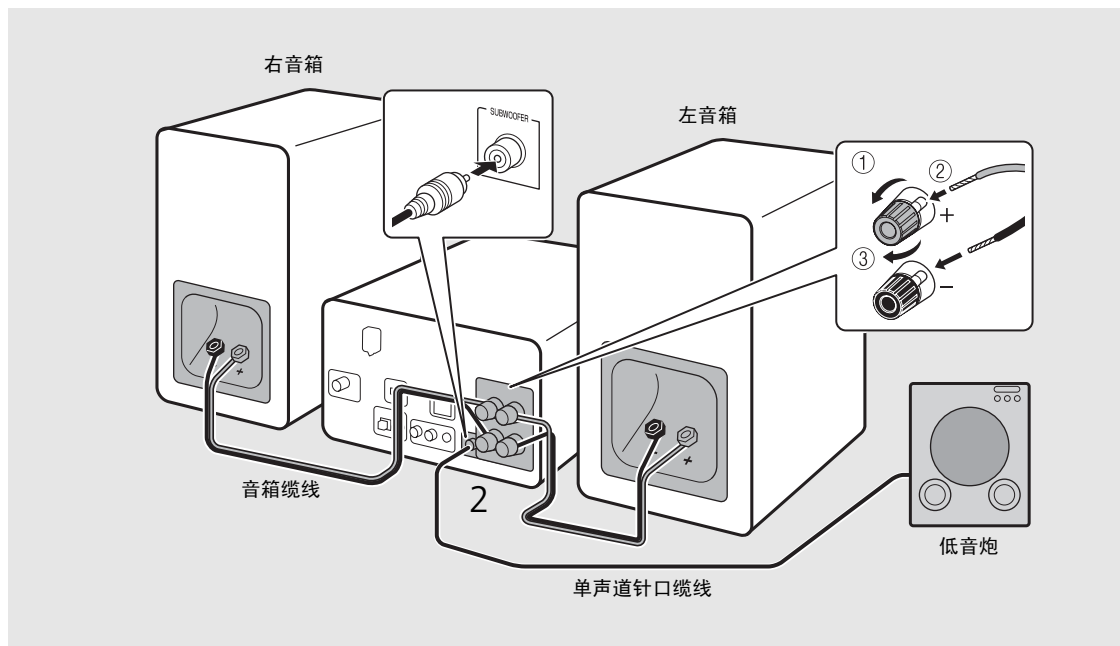

- 注意不要让裸露的音箱导线互相接触或接触到本机的任何金属部分。否则可能损坏本机和 / 或音箱。
- 确保左右侧 (L、R) 连接和极性 (红色: +, 黑色: -) 正确。如果连接不正确, 音质会不自然。
- 使用阻抗至少为 6Ω 的音箱。
- 也可将带有内置放大器的低音炮连接到本机。

连接天线

- 1 将附带的天线连接至本机。
- 2 使用大头针将其安装在本装置接收信号良好的地方。

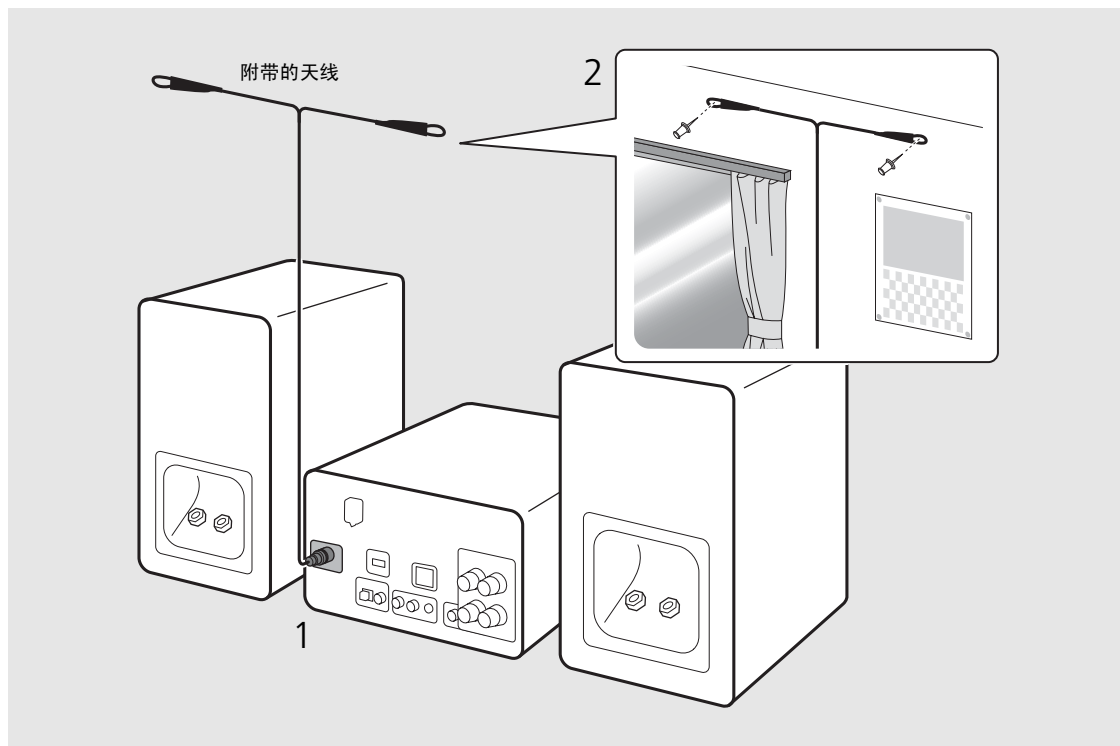

- 确保按照图示拉出天线。
- 如果使用附带的天线时无线电接收不良，市售的室外天线可能会改善接收效果。

连接至网络

将本机连接至网络后，可播放存储在 PC、移动装置、DLNA* 兼容 NAS 上的音乐文件或者网络上的音频内容。也可通过移动装置操作本机。

* Digital Living Network Alliance

如右图所示，将本机连接至网络。

- 使用市售 STP（屏蔽双绞线）网线（CAT-5 或更高速度的直通缆线）连接。

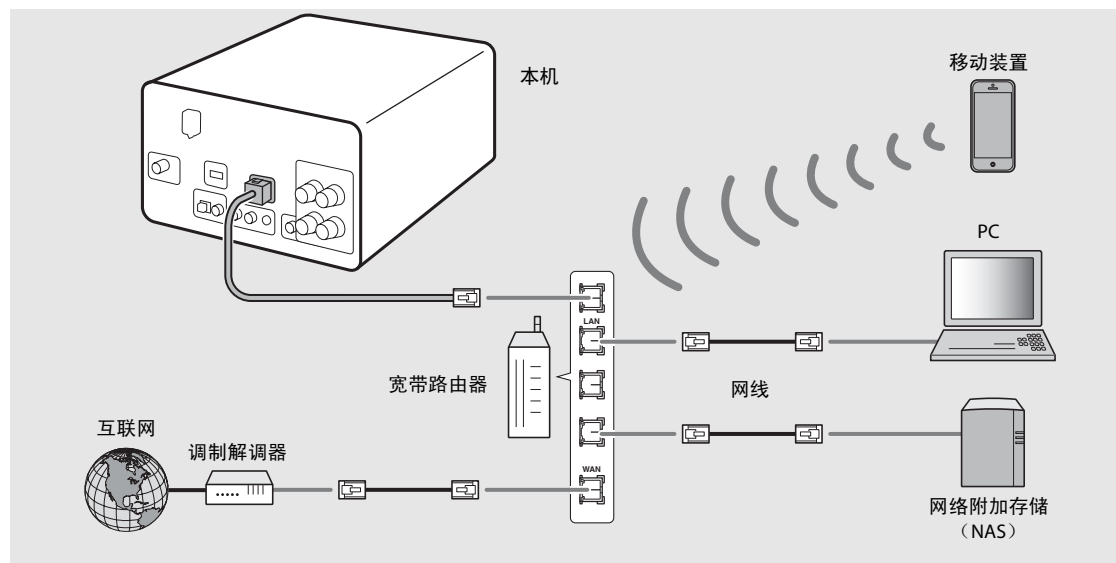

- 有关网络连接的详情，请参阅网络装置的使用说明书。
- 如果您使用的路由器支持 DHCP，则不需要为本机配置任何网络设置。如果您使用的路由器不支持 DHCP，请在选项设置的 [Network Config] 中配置网络设置（☞ 第 31 页）。
- 为确保出色的音质，建议对除手机之外的装置使用有线连接。
- PC 上安装的某些安全软件或网络装置（如路由器）的防火墙设置可能会阻止本机访问网络装置或互联网。这时，需要更改安全软件或网络装置的设置。
- 在手动设定子网时，必须将每台服务器连接至本机所在的子网（☞ 第 32 页）。

打开电源

将电源线插入壁上插座并按 。



- 本机开启。
- 再次按  可关闭本机（待机模式）。
- “省电待机”（默认）可减少本机的耗电量，但同时会限制某些功能（如右表所示）。

取消省电待机

1 按 。

- 前面板显示屏上显示选项菜单。

2 取消省电待机。

- 按照 [System Config] - [Power Saving] - [Normal] 的顺序设定该项目。
- 通过  更改该项目，并按  进行设定。

3 按  结束选项设置。

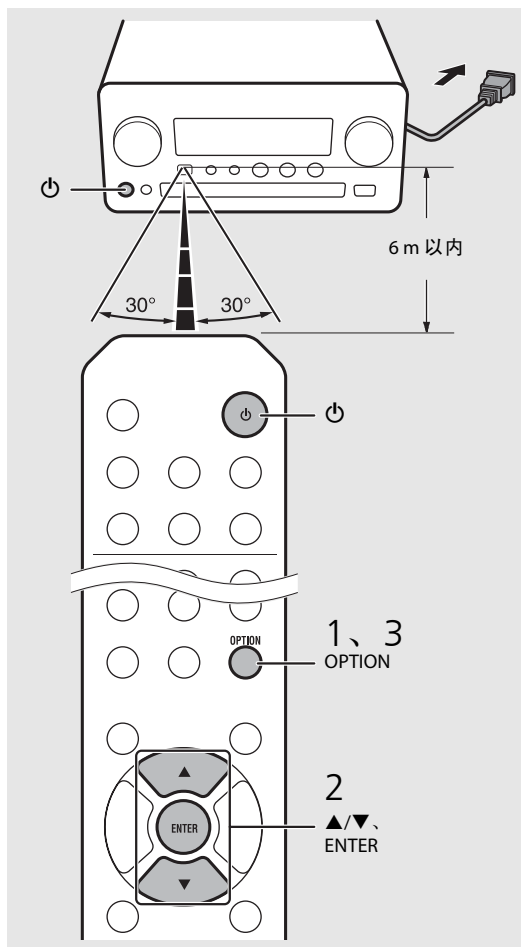

待机 / 省电待机中的状态

	待机	省电待机
iPod/USB 装置充电	✓	—
启用 / 禁用闹铃定时器 *	✓	—
音频源按钮的操作 *	✓	✓
装入 / 弹出 CD	✓	✓
AirPlay	✓	—
通过应用程序接通电源	✓	—
时钟显示	✓	—

* 仅可使用遥控器操作

关于电源的选项菜单（System Config）

（设置值。粗体：默认）

Power Saving

配置电源设置。

（Normal、Eco）

当您选择 [Eco] 时，省电待机模式下前面板显示屏上不显示任何内容。

Auto Power Off

设定本机在不执行任何操作的情况下进入待机模式前的时间。

（Timer 2H、Timer 4H、**Timer 8H**、Timer 12H、OFF）

设定网络装置

配置连接至网络的装置以播放存储在 PC 或 NAS 上的音乐文件，或配置移动装置以控制本机。

PC

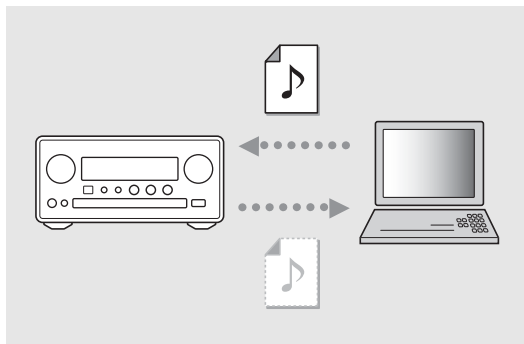

配置 PC 的媒体共享设置
(☞ 第 17 页)。

NAS

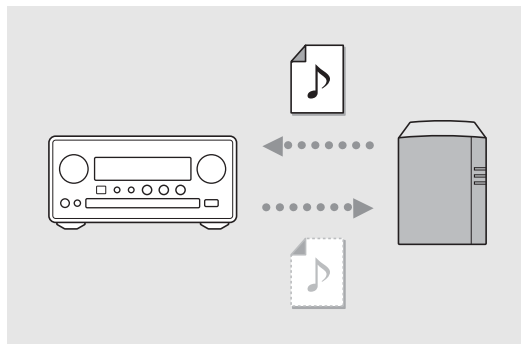

配置访问 NAS 的设置。

- 如有需要，启用 NAS 的 DHCP 设置。
- 有关更多详细的设置，请参阅 NAS 附带的使用说明书。

移动装置

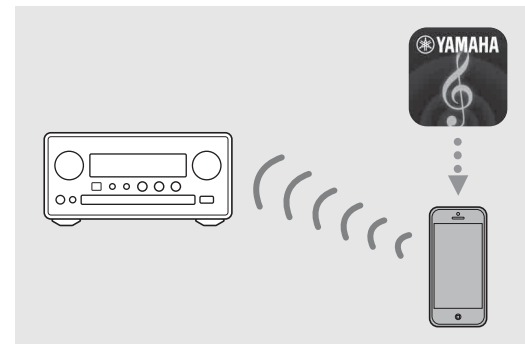



将专门的应用程序“NETWORK
PLAYER CONTROLLER”安装至移动
装置 (☞ 第 18 页)。

- 该应用程序支持 iPhone/iPad/iPod touch 和 Android 移动装置。
- 移动装置需要连接至本机连接的同一个路由器。

聆听 CD

本机可以播放录有 MP3/WMA 文件的音频 CD 和数据 CD。
有关可播放 CD 的详情，请参阅“支持的装置 / 媒体”（第 39 页）。

- 1 转动 INPUT 以选择 [CD]。或者，按遥控器上的 。
- 2 将 CD 装入光盘托盘。
 - 按  打开 / 关闭光盘托盘。
- 3 播放开始。
 - 遥控功能如下所示。

	在播放 MP3/WMA 文件时跳转至上一个或下一个文件夹的第一个文件。
	播放 / 暂停
	停止
	跳转至正在播放的歌曲的开头或者上一首歌曲。
	跳转至下一首歌曲。
	开始随机播放（  第 20 页）。
	开始重复播放（  第 20 页）。
1 - 9, 0	指定歌曲编号。
RETURN	取消歌曲编号。
ENTER	应用歌曲编号。

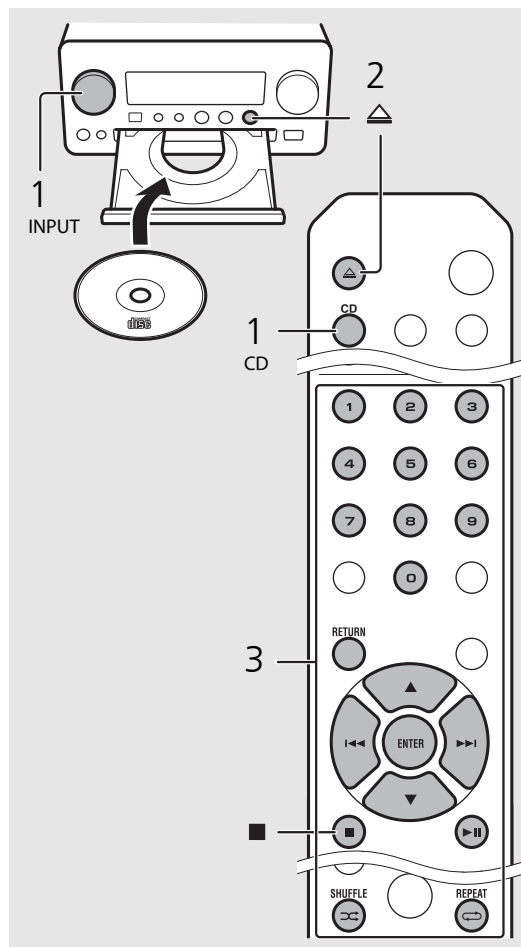

- 数据 CD 上的文件按照字母数字顺序播放。
- 当 CD 播放停止时，会继续从上次播放歌曲的开头继续播放。在播放停止时按  会撤销继续播放。

聆听 iPod/USB 装置中的音频

本机可以播放存储有音乐文件的 iPod 或 USB 装置。

有关可播放 iPod/USB 装置的详情，请参阅“支持的装置 / 媒体和文件格式”（第 39 页）。

播放 iPod

- 1 转动 INPUT 以选择 [USB]，或者按遥控器上的 。
- 2 将 iPod 连接至 USB 插孔。
 - 准备 iPod 附带的 USB 缆线。
 - 音频源更改为 [iPod]。
- 3 播放开始（☞ 第 16 页）。

播放 USB 装置

- 1 转动 INPUT 以选择 [USB]。或者，按遥控器上的 。
- 2 将 USB 装置连接至 USB 端口。
- 3 播放开始（☞ 第 16 页）。

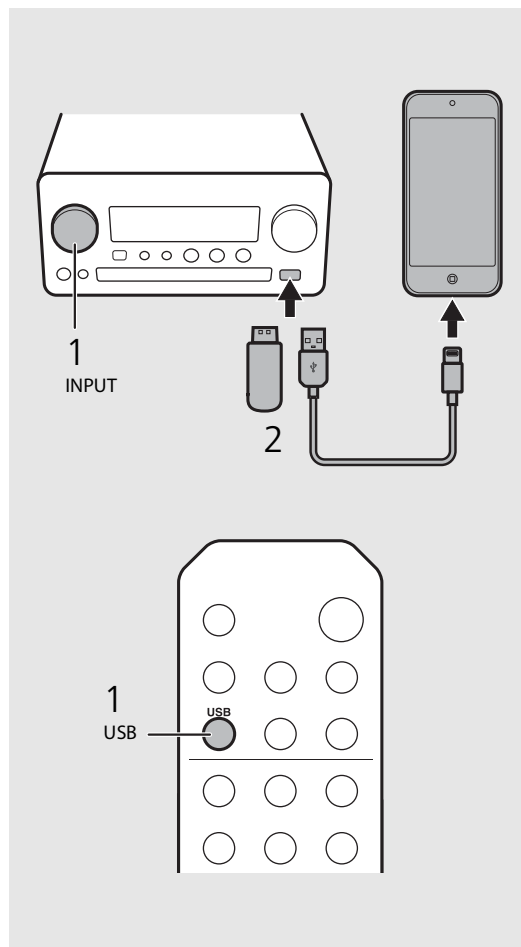







- 某些 iPod/USB 装置即使符合要求也可能无法正常工作。不保证可以播放所有 iPod/USB 装置以及对其进行供电。
- Yamaha 和供应商对连接至本机的 iPod 或 USB 装置上所存储数据的损失不承担任何责任。作为防范措施，建议对重要文件进行备份。



- 请在断开 USB 装置前先停止播放。
- 当连接至本机时，iPod 或 USB 装置会自动充电，省电待机模式除外。

iPods/USB 装置的遥控操作

	跳转至正在播放的歌曲的开头或上一首歌曲（对于 iPod，按住该键可快退）。
	跳转至下一首歌曲（对于 iPod，按住该键可快进）。
	停止
	播放 / 暂停
	随机播放（☞ 第 20 页）
	重复播放（☞ 第 20 页）

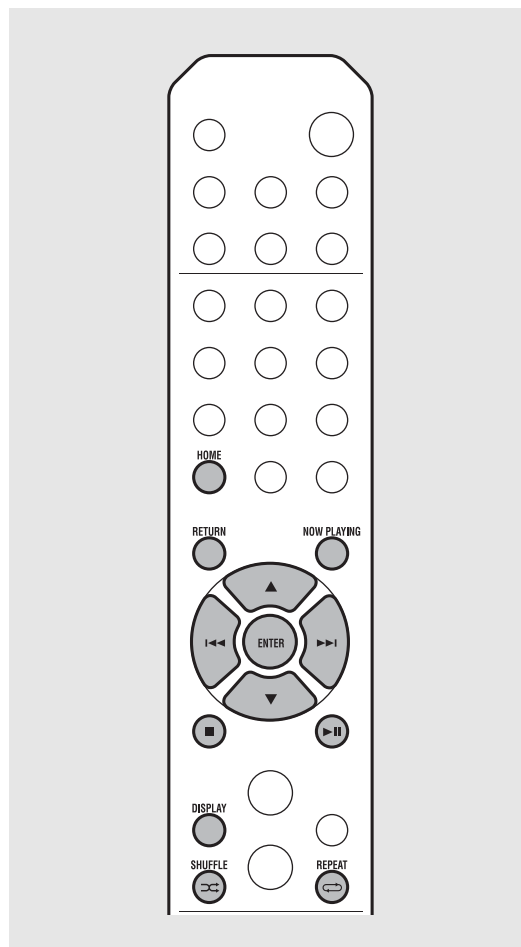

切换 iPod 的信息显示

- 当通过 Yamaha 的应用程序“NETWORK PLAYER CONTROLLER”操作 iPod 时，信息显示切换至扩展模式。若要切换信息显示模式，按住 **DISPLAY** 按钮。

- **标准模式**（默认）：看着 iPod 的屏幕来操作 iPod，并选择歌曲进行播放。
- **扩展模式**：看着前面板显示屏上显示的 iPod 信息来操作遥控器（浏览操作），并选择歌曲进行播放。遥控功能如下所示。

	显示其他项目。
ENTER	确认所选项目并继续进入下一层级或开始播放。
HOME	显示顶层项目。
RETURN	返回至上一项目。
NOW PLAYING	结束浏览并显示播放内容信息。

聆听电脑中的歌曲

本机可以播放连接至网络或 NAS 的电脑（服务器）中存储的音乐文件，如 MP3、WMA 或 FLAC（无损音频数据压缩格式）文件。浏览前面板显示屏并选择您喜欢的音乐文件。

■ 设定音乐文件媒体共享

若要用本机播放电脑中存储的音乐文件，需要在本机和电脑之间进行媒体共享设置（Windows Media Player 11 或更新版本）。在此，以 Windows 7 中 Windows Media Player 12 的设置为例。

- 1 启动 PC 上的 Windows Media Player 12。
- 2 选择“媒体流”，然后选择“打开媒体流”。
 - 出现 PC 控制面板窗口。
- 3 点击“启用媒体流”。
- 4 从“CRX-N560”旁边的下拉列表中选择“已允许”。
- 5 点击“确定”退出。

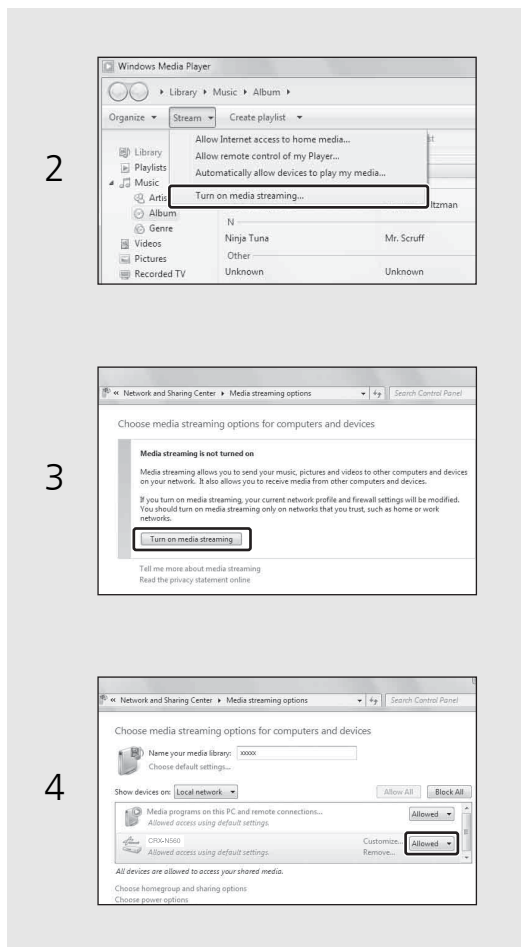

- 有关媒体共享设置的详情，请参阅 Windows Media Player 帮助。

对于 Windows Media Player 11

- 1 启动 PC 上的 Windows Media Player 11。
- 2 选择“媒体库”，然后选择“媒体共享”。
- 3 勾选“共享媒体的位置”复选框，选择“CRX-N560”图标，然后点击“允许”。
- 4 点击“确定”退出。

对于安装了其他 DLNA 服务器软件的 PC 或 NAS

参阅相关装置或软件的使用说明书，然后配置媒体共享设置。



播放 PC 中的歌曲

1 反复按  选择 [Server]。

2 浏览并选择一首歌曲。

▲/▼	显示其他项目。
ENTER	确认所选项目并继续进入下一层级或开始播放。
HOME	显示顶层项目。
RETURN	返回至上一项目。
NOW PLAYING	结束浏览并显示播放内容信息。

3 开始播放。

	播放 / 暂停
	跳转至文件夹中的下一首或上一首歌曲。
	停止
	随机播放 (☞ 第 20 页)
	重复播放 (☞ 第 20 页)

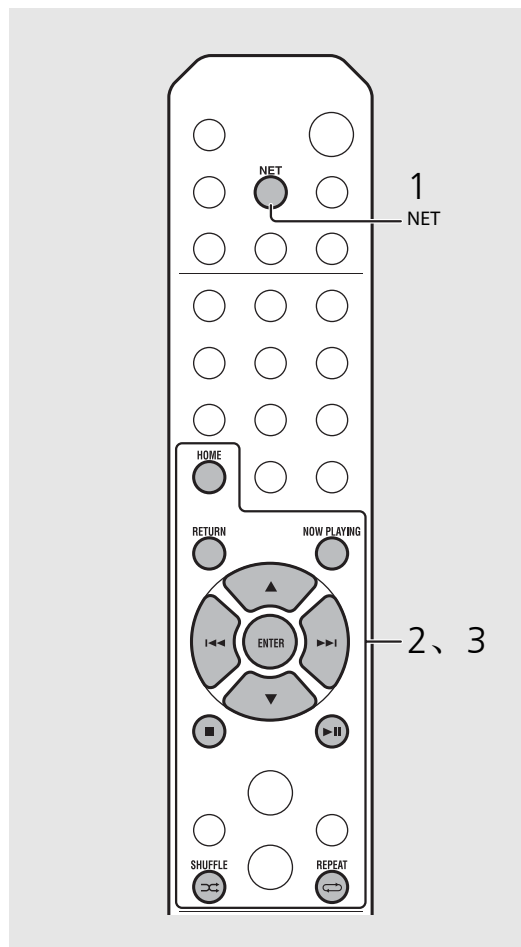

- 如果不能播放，确保本机和 PC（服务器）已连接至同一个路由器（☞ 第 11 页）。

从移动装置操作

在移动装置中安装了应用程序“NETWORK PLAYER CONTROLLER”之后，就可以通过移动装置操作本机。

- 功能
 - 打开 / 关闭电源，调节音量或其它基本操作
 - 更改音乐源
 - 显示无线电调谐器信息
 - 选择、播放和停止播放歌曲
 - 播放装置中存储的歌曲

有关下载应用程序或最新信息，请访问 App Store 或 Google Play 并搜索“NETWORK PLAYER CONTROLLER”。

聆听外部音频源





本机可以播放外部装置，如 DVD 播放器或移动音乐播放器。根据要连接的装置使用端子（DIGITAL IN 1/2 或 AUX 1/2）（☞ 第 6 页）。有关连接各外部装置，请参阅装置附带的使用说明书。

1 拔下本机的电源线，将外部装置连接至本机。

- 准备市售缆线以备连接。

2 将本机的电源线插入壁上插座，按 打开本机。

3 更改音乐源。

- 根据想要播放的外部装置，按下对应的连接端子  或 。
- 按  将音频源更改为 AUX1/AUX2（模拟输入），按  将音频源更改为 DIGITAL IN1/DIGITAL IN2（数字输入）。

4 播放连接的外部装置。

- 有关播放的详情，请参阅外部装置附带的使用说明书。

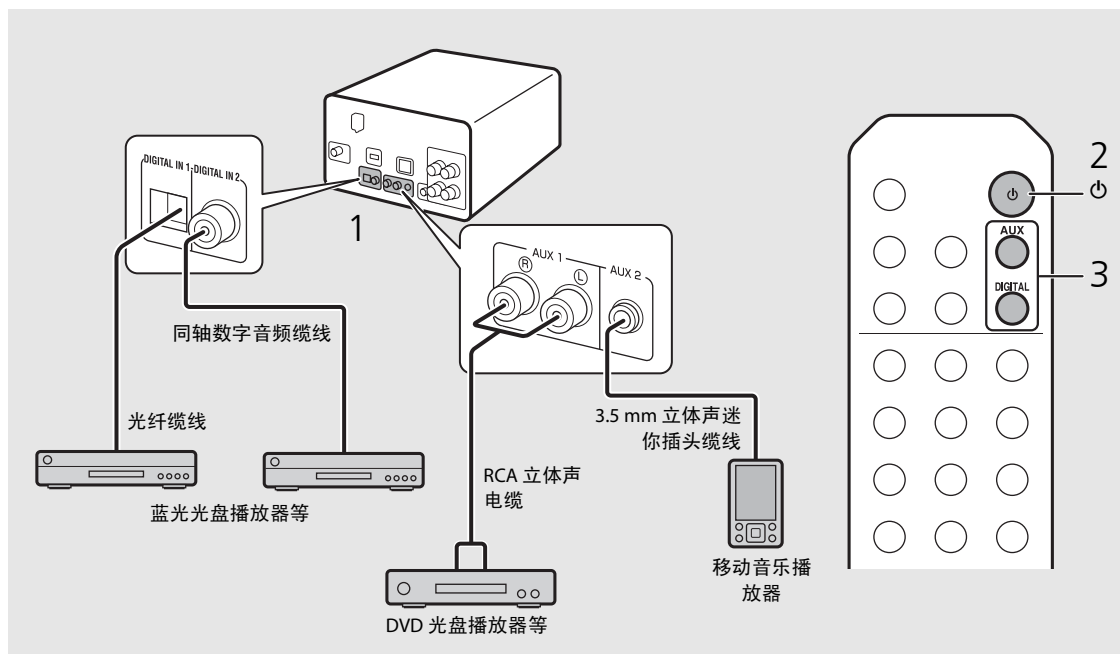

- 连接之前，请调低本机和外部装置的音量。否则，播放音量可能太大声。

关于播放的更多信息

可以不同歌曲顺序或音质播放音乐，并可在播放期间查看音乐信息。
本章节描述的操作适用于所有装置，如 PC（服务器）、iPod、USB 装置或 CD。

随机播放

在播放期间按 。

- 每按一次该按钮，前面板显示屏上的随机播放指示就会如下切换。



 ALL	执行随机播放。*
未显示	不执行随机播放。

* 随机播放的范围取决于正在播放的媒体。

重复播放

在播放期间按 。

- 每按一次该按钮，前面板显示屏上的重复播放指示就会如下切换。

 1	重复播放正在播放的歌曲。
ALL 	执行重复播放。*
未显示	不执行重复播放。

* 重复播放的范围取决于播放媒体。

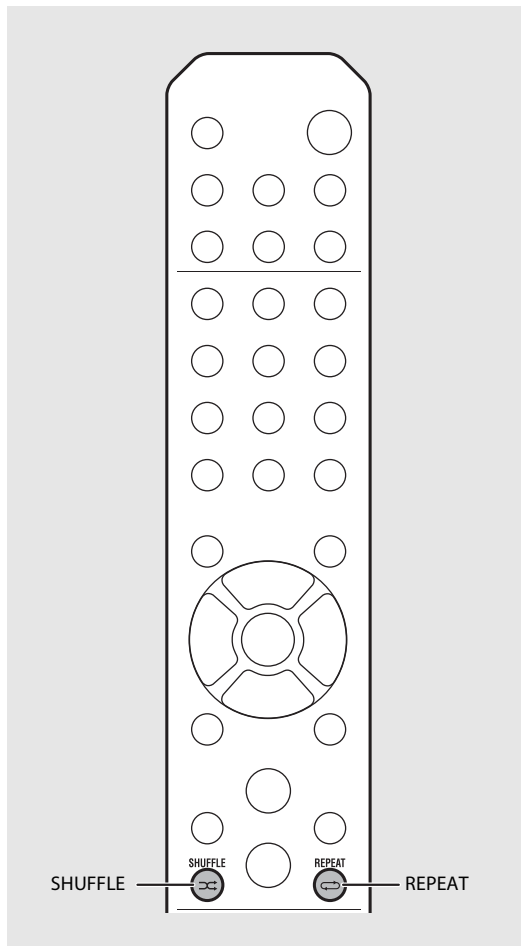

- 随机播放和重复播放可以同时执行（ 1 除外）。

播放信息

歌曲标题、已播放的时间等可显示在前面板显示屏上。

在播放期间按 。



• 每按一次 , 显示按照如下顺序切换。

USB/iPod/AirPlay/Server	CD
歌曲标题 *1	播放时间
专辑标题	歌曲剩余时间 *2
艺术家姓名	光盘剩余时间 *2
播放时间	歌曲标题 *1、3
	专辑名称 *3
	艺术家姓名 *3

*1 如果无法获取歌曲标题，可能不会显示文件标题。

*2 仅在播放音频 CD 时。

*3 仅在播放音频 CD 和有信息要显示时。

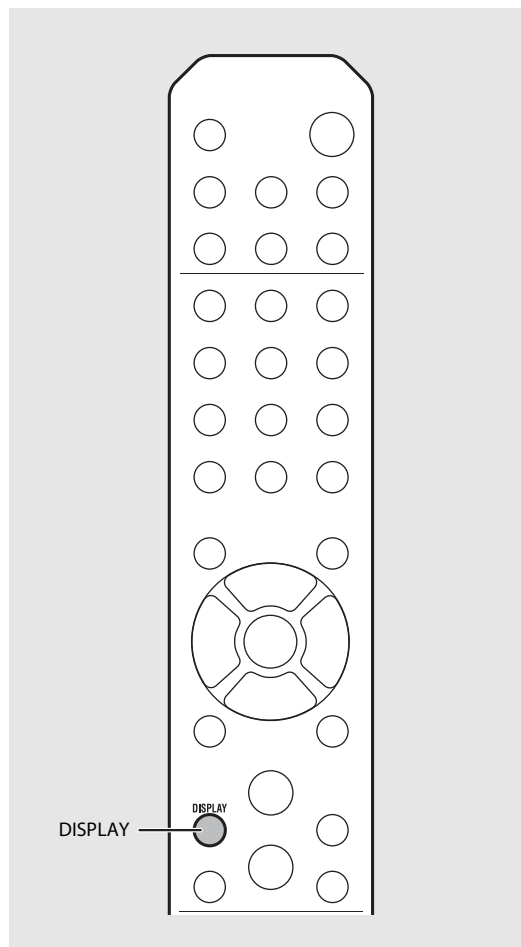

- 前面板显示屏上显示的字符只有字母数字。
- 当 iPod 显示模式为标准模式时，不会显示信息（☞ 第 16 页）。

调节音质

使用选项设置调节音质。

- 1 按 **OPTION**。
 - 前面板显示屏上显示选项菜单。
- 2 按 **▲/▼** 选择所需项目并按 **ENTER**。
- 3 按 **▲/▼** 更改所需项目并按 **ENTER**。
 - 设置即被应用。
 - 按 **RETURN** 返回至前一个项目。
 - 若要取消音质设置，请按 **OPTION**。
 - 若要设定其它项目，请重复步骤 2 和 3。
- 4 按 **OPTION** 结束选项设置。

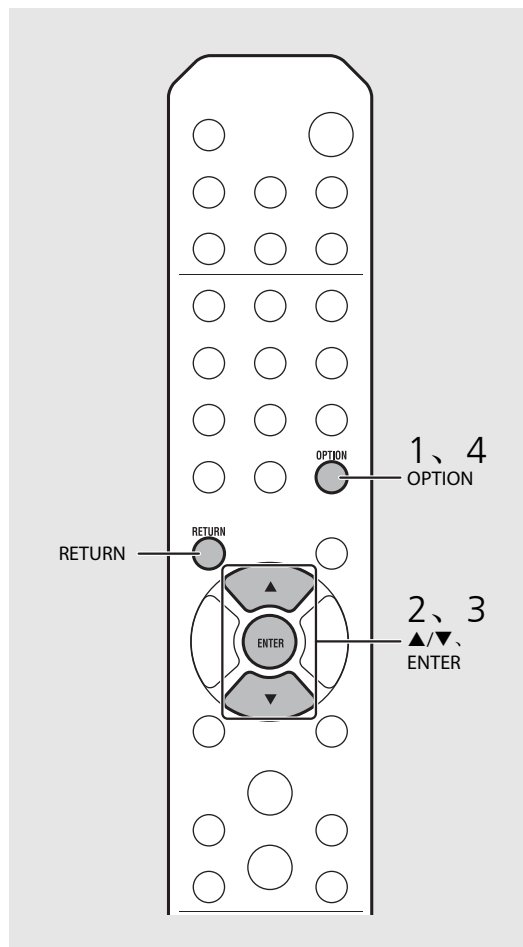

关于音质的选项菜单

(设置值。粗体: 默认)

Equalizer

调节低频 [EQ Low]、中频 [EQ Mid] 和 高频 [EQ High]。
此设置在使用耳机时也适用。
(-10 至 **0** 至 +10)

Balance

调节左、右音箱的音量平衡。此设置在使用耳机时不适用。
(Lch. +10 至 **--CENTER--** 至 Rch. +10)

Music Enhancer

恢复因压缩丢失的音乐元素。
(ON、**OFF**)
当播放高质量音乐源时，如 FLAC 或 WAV，建议设定为 [OFF]。当播放未经压缩的音频 CD 时，即使设定了 [ON]，此功能也不可用。

收听 FM 电台

若要收听 FM 电台，请连接附带的天线。
有关将天线连接至本机，请参阅“连接天线”（第 10 页）。

FM 电台调谐

- 1 按 **RADIO**。
- 2 按住 **TUNING** (◀/▶)。
 - 开始自动调谐，当调入一个电台时，自动停止调谐。

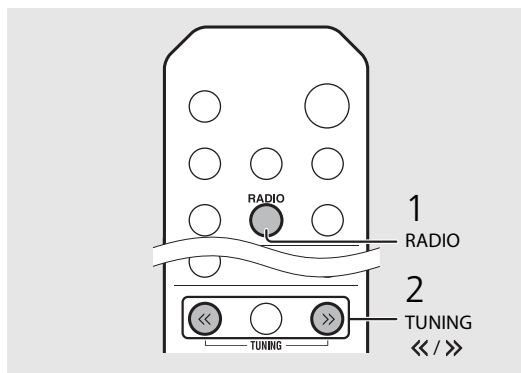

- 如果电台接收很差，可反复按 **TUNING** (◀/▶) 按钮手动调谐至一个电台。

预设 FM 电台

自动预设

调谐接收良好的电台，并对其进行自动预设。

- 1 按 **RADIO**。
- 2 按住 **MEMORY** 2 秒以上。
- 3 按 **MEMORY**。
 - 自动预设开始；当自动预设完成时，前面板显示屏上会显示“Completed!”。

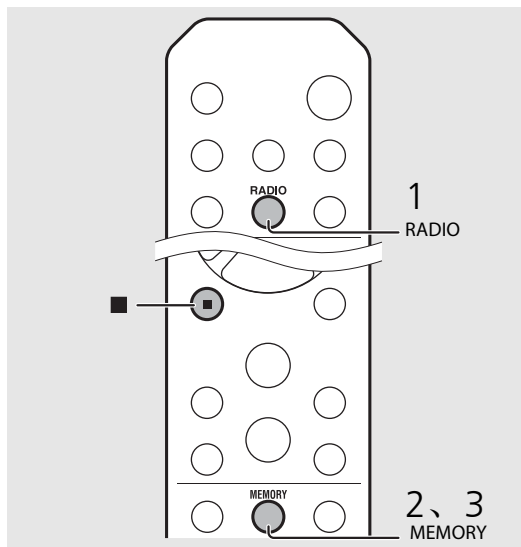

- 自动预设会将现存的所有电台更换为新存储的电台。



- 最多可以预设 30 个 FM 电台。
- 若要取消自动预设，请按 ■。

手动预设

1 调谐至想要存储的电台
(☞ 第 23 页)。

2 按 。

- 预设编号在前面板显示屏上闪烁。



3 按  选择所需预设编号。

4 按  预设电台。

选择预设的 FM 电台

1 按 。

2 按 PRESET  /  选择电台。

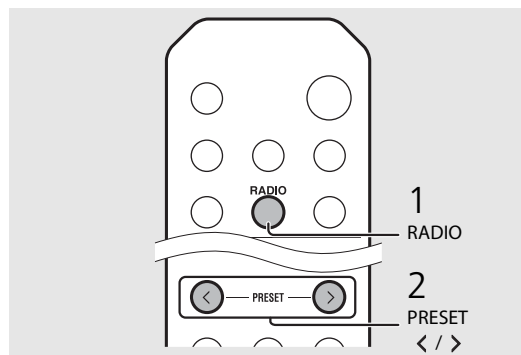
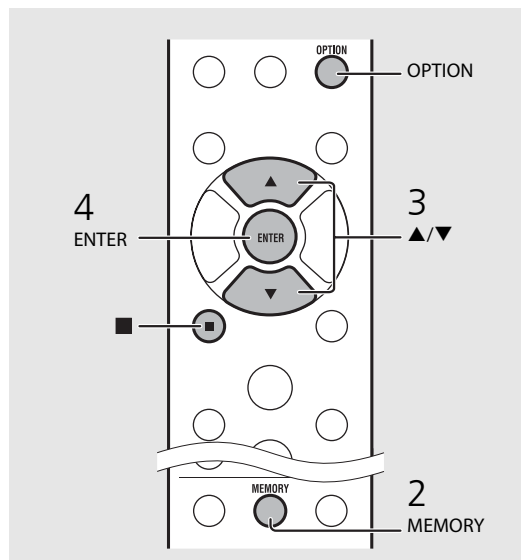

- 若要取消手动预设设置，请按 。

删除预设电台

使用选项设置删除预设电台。

1 当音频源是 FM 时按 。

- 前面板显示屏上显示选项菜单。

- 若要取消删除预设电台，请按 。

2 按  选择 [Preset Delete] 并按 。

3 按  选择要删除的预设编号。

4 按 。

- 预设电台被删除，前面板显示屏上显示 [Deleted]。

5 按  结束选项设置。

收听网络电台

可通过互联网收听全世界的电台。
确保本机已正确连接至互联网（☞ 第 11 页）。

1 反复按  选择 [Net Radio]。

2 浏览互联网并选择一个电台。



• 遥控功能如下所示。

▲/▼	显示其他项目。
ENTER	确认所选项目并继续进入下一层级或开始播放。
HOME	显示顶层项目。
RETURN	返回至上一项目。
NOW PLAYING	结束浏览并显示播放内容信息。

3 播放开始。

• 若要停止播放，请按 。

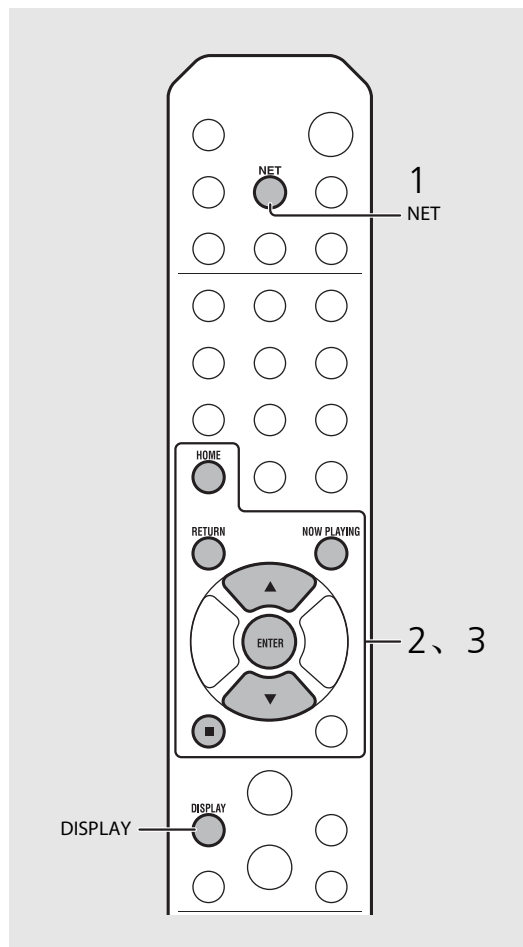

• 当正在播放网络电台时，按 **DISPLAY** 按钮可显示播放信息。每按一次该按钮，信息如下改变。

电台名称（默认）
歌曲标题
播放时间

• 可以通过选择 [Net Radio] 作为本机上的音频源，然后利用 PC 上的网页浏览器访问以下网站，将您喜爱的网络电台加入“收藏夹”文件夹。
<http://yradio.vtuner.com/>
若要使用此功能，需要本机的 vTuner ID 以及您的电子邮件地址，以便创建您的个人帐户。可在选项设置的 [Network Info]（☞ 第 32 页）中查看 vTuner ID（本机的 MAC 地址）。

使用 AirPlay 听音乐

利用 AirPlay 功能，您可通过网络在本机上无线播放 iTunes/iPod 音乐。
确保将本机及 PC 或 iPod 连接至同一路由器（☞ 第 11 页）。

播放 iPod

- 1 打开本机，在 iPod 上显示播放画面。
 - 如果 iPod 能够识别本机，iPod 的画面会上显示 。
- 2 轻触 ，选择本机的名称。
 - 音频源自动切换至 [AirPlay]，播放开始（在省电待机模式中除外）。



播放 iTunes

- 1 打开本机，启动 iTunes。
 - 如果 iTunes 能够识别本机，iTunes 的画面会上显示 。
- 2 点击 ，选择本机的名称。
 - 音频源自动切换至 [AirPlay]（在省电待机模式中除外）。
- 3 使用 iTunes 播放歌曲。

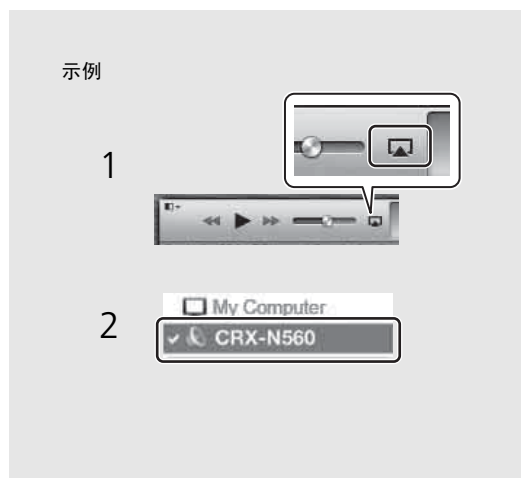

- 使用 iTunes/iPod 控制器来调节音量时，音量可能会意外变大。这可能会导致本机或音箱损坏。如果在播放期间音量变大，请立即停止在 iTunes/iPod 上播放。



- 也可使用本机和遥控器来播放、暂停、停止和跳过歌曲。
- 若要使用遥控器控制 iTunes 播放，需要预先将 iTunes 首选项配置为允许从远程音箱控制 iTunes。

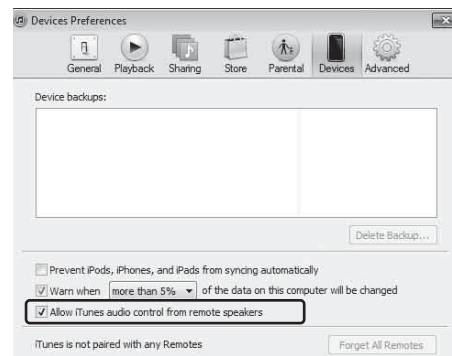

清除 AirPlay

- 轻触 / 点击 iPod/iTunes 画面上的  并从音箱列表中选择 CRX-N560 以外的装置。或者，更改至 AirPlay 以外的音频源。

使用时钟

设定时钟之后，可以播放您喜爱的歌曲或电台节目作为闹铃。

设定时钟

- 1 按 **OPTION**。
 - 前面板显示屏上显示选项菜单。
- 2 通过 **▲/▼** 选择 [System Config] 并按 **ENTER**。
- 3 通过 **▲/▼** 选择 [Clock Setting] 并按 **ENTER**。



- 4 设定日期和时间。
 - 通过 **▲/▼** 更改设置并按 **ENTER** 确认。
 - 按照年、月、日、时和分的顺序执行此步骤。
 - 若要取消设置，请按 **RETURN**。
 - 当设置完成时，显示 [Completed!]。
- 5 按 **OPTION** 结束选项设置。

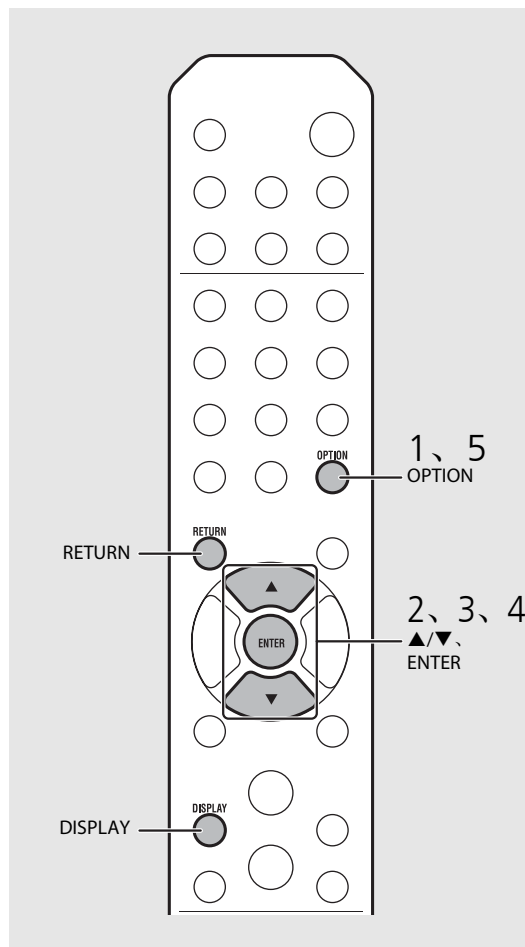

- 如果从壁上插座断开电源线约一周，时钟设置将会丢失。再次设定时钟。



- 在设定时钟时，如果按 **DISPLAY** 按钮，时钟格式（12 小时制 /24 小时制）将改变。

设定闹铃定时器





在您设定的时间，音乐或哔哔声将会响起。

1 按住 。

- 前面板显示屏上显示 [Timer Setting] 和时间，且  和小时数闪烁。



2 设定以下项目，①至③。

- 按 / 选择设置值，并按  设定项目。
- 显示切换至下一个项目。
- 若要取消设置，请按 。

① 开始时间

设定小时和分钟。

② 音量

可在 [5] 至 [59] 和 [MAX] 之间设定。

③ 重复设置

Repeat: 闹铃定时器每天都在设定的时间响起。

No Repeat: 闹铃定时器只响一次。

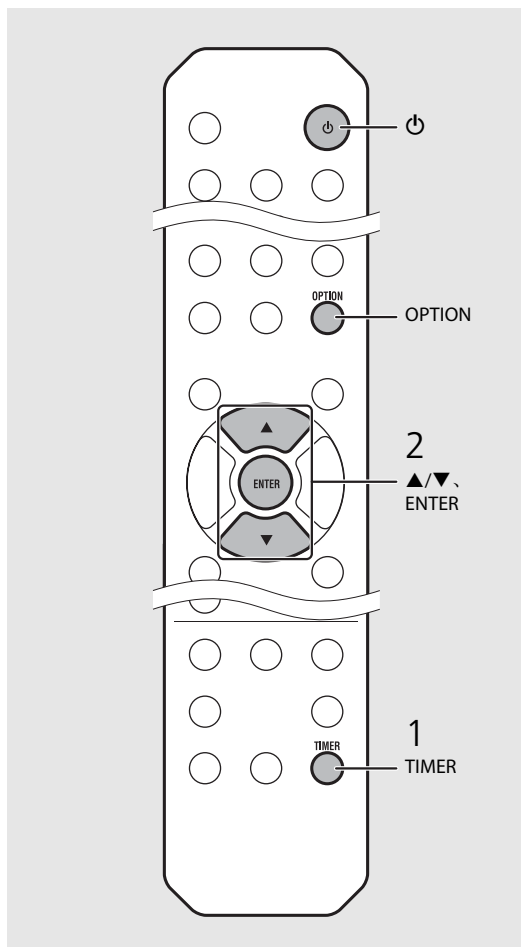

- 在设定闹铃定时器之前先设定闹钟。
- 当 [Power saving] 设为 [Eco] 时，闹铃定时器不可用。将其设为 [Normal] ( 第 12 页)。



- 也可使用选项设置设定闹铃定时器。

1 按 。

- 前面板显示屏上显示设置菜单。

2 按 / 选择 [Timer Setting] 并按 。

3 执行左侧的步骤 2。

4 按 结束选项设置。

5 设定音乐源，播放该音乐源，并按 。

继续下一页 →

- 当设置完成时，前面板显示屏上会显示 [Completed!]，且  点亮。





3 按 .

- 在您设定的时间，本机进入待机模式，哔哔声响起。
- 如果想在设定的时间播放音乐，在本步骤中，选择一个音频源进行播放，然后再按 。有关音频源播放的详情，请参阅右侧提示最后面的 (*) 内容。



睡眠定时器

可以设定经过多少时间之后本机自动进入待机模式。

按  几次，以选择时间。

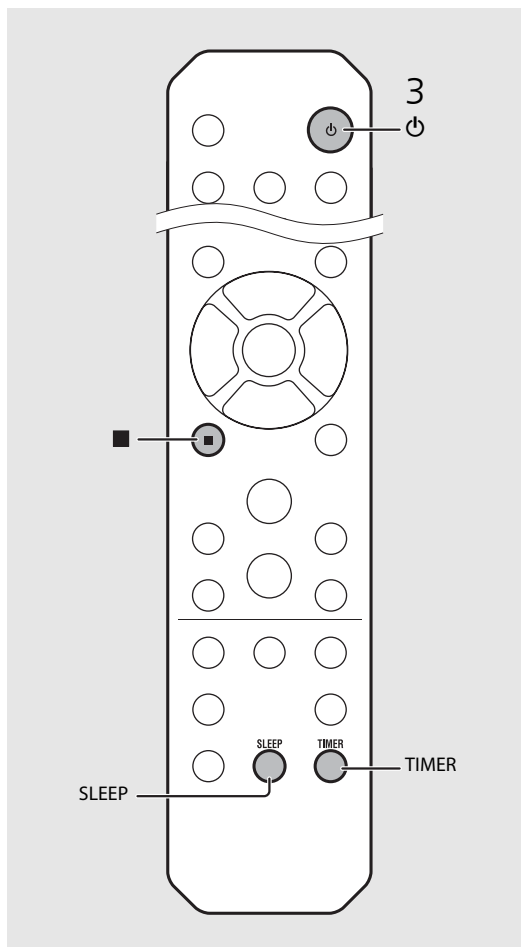





- 可以选择的时间有 30/60/90/120 分钟，或者 OFF。
-  在选择了时间并设定了睡眠定时器之后立刻点亮。
- 若要取消睡眠定时器，再次按 .



- 如果在设定了闹铃定时器之后从本机删除音频源，本机将在设定的开始时间发出哔哔声。
 - 如果到达开始时间时正在播放任何音乐源， 闪烁，播放将继续进行。
 - 在设定了闹铃定时器之后，可在本机开启时按 **TIMER** 按钮来启用或禁用定时器。
 - 若要停止哔哔声，按  或 ；否则将在 60 分钟后停止。
- * 当音乐源设为 AUX、Server、DIGITAL IN 或 AirPlay 时，本机在到达开始时间时将发出哔哔声。

更新固件

发布了新固件后，前面板显示屏上将显示更新现有固件的信息（仅适用于本机连接至互联网时）。此页面显示使用选项设置通过网络进行更新的方法。

- 1 按 。
 - 前面板显示屏上显示选项菜单。
- 2 通过  选择 [System Config] 并按 。
- 3 通过  选择 [Firm Update] 并按 。
- 4 通过  选择 [Network] 并按 。
 - 更新开始。



- 当更新完成后，依次显示以下信息：“Update success.”、“Please...” 和 “power off!”。
- 5 从壁上插座拔出电源线，并在约 30 秒后重新插上。
 - 更新已应用。

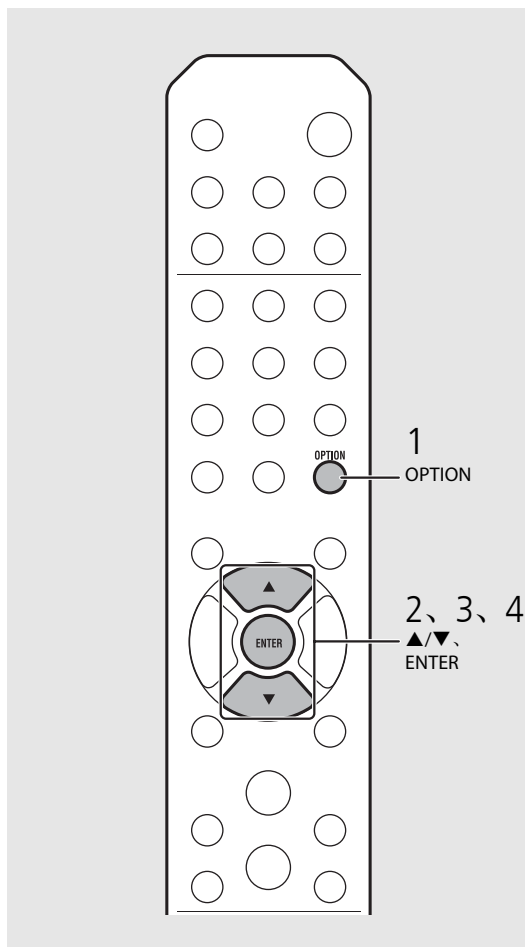

- 在固件更新期间，请不要操作本机或断开电源线或网线。



- 一旦前面板显示屏上出现提示更新的信息后，即使您不执行更新，也不会再次出现。但是，在电源线从壁上插座断开一段时间之后，再打开本机时，将出现该信息。
- 当网速不够快或本机通过无线网络适配器连接到无线网络时，则可能无法进行网络更新，具体取决于无线连接的情况。在此情况下，可再次尝试或使用 USB 存储装置更新固件。固件可从 Yamaha 网站下载。



使用 USB 存储装置更新固件





可将固件下载至 USB 存储装置，并将 USB 存储装置连接至本机上的 USB 插孔。

- 在步骤 4 中选择 [USB]，并按 **ENTER** 按钮开始更新。

选项设置

选项设置用于根据您的使用情况配置本机。

- 1 按 。
 - 前面板显示屏上显示选项菜单（☞ 第 32 页）。
- 2 通过 ▲/▼ 选择所需选项菜单并按 。

- 3 通过 ▲/▼ 更改设置并按 。
 - 如果需要设定子菜单，重复步骤 3。
 - 按  取消设置并返回至上一级。
 - 如果还要设定另一个菜单项，重复步骤 2 和步骤 3。
- 4 按  结束选项设置。

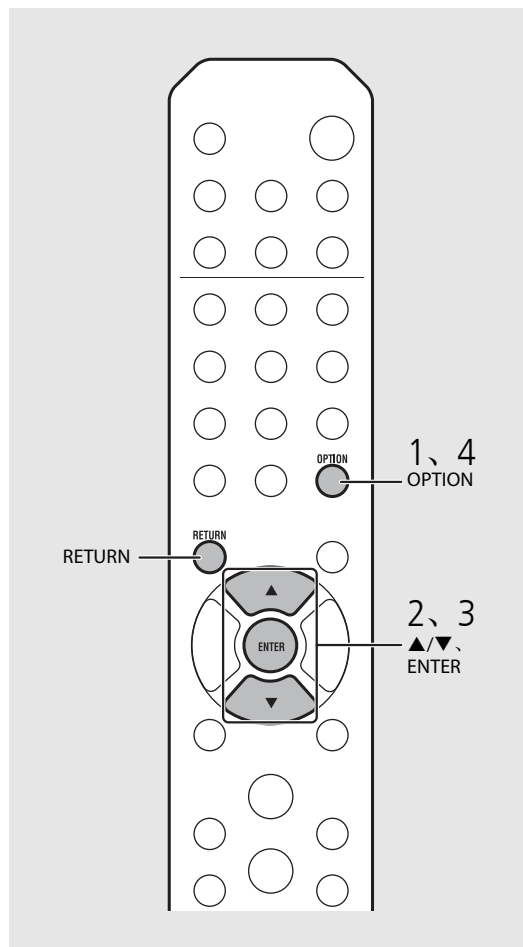

- 若要在选项菜单中设定 [Advanced Setup]，按遥控器上的 **OPTION** 按钮，同时按住本机上的 （停止按钮），然后执行步骤 3。

选项菜单列表

菜单	子菜单	默认值	功能
Preset Delete* ¹ (☞ 第 24 页)			删除预设电台。
Equalizer (☞ 第 22 页)	EQ Low	0	调节低频。
	EQ Mid	0	调节中频。
	EQ High	0	调节高频。
Balance (☞ 第 22 页)		CENTER	调节左、右音箱的音量平衡。
Music Enhancer (☞ 第 22 页)		OFF	启用 / 禁用 Music Enhancer。
Timer Setting (☞ 第 28 页)			设定闹铃定时器。
Network Info	Network Status		显示本机和网络的连接状态。
	MAC Address		显示 MAC 地址。
	System ID		显示系统 ID。
	Network Name		显示出现在网络上的本机名称。

菜单	子菜单	默认值	功能
Network Config	DHCP Enabled	YES	启用 / 禁用 DHCP。
	IP Address	0.0.0.0	确认和设定 IP 地址。
	Subnet Mask	0.0.0.0	确认和设定子网掩码。
	Def. Gateway	0.0.0.0	确认和设定默认网关。
	DNS Server(P)	0.0.0.0	确认和设定首选 DNS 服务器。
	DNS Server(S)	0.0.0.0	确认和设定备用 DNS 服务器。
System Config	Clock Setting		设定本机的时钟 (☞ 第 27 页)。
	Power Saving	Eco	设定省电待机 (☞ 第 12 页)。
	Auto Power Off	Timer 8H	设定本机自动进入待机模式 (☞ 第 12 页)。
	Use Accessory	NO	选择是否通过 DC OUT 插孔连接的 Yamaha 配件供电。
	Firm Version		显示本机的固件版本。
	Firm Update	Network	更新本机的固件 (☞ 第 30 页)。

Advanced Setup (☞ 第 31 页)	MAC Add.Filter	OFF	指定 MAC 地址 (最多 5 个) 并限制网络组件对本机的访问。 (即使 [MAC Add.Filter] 设为 [ON], 通过 AirPlay 的操作也不受影响。)
	Factory Reset		将本机的设置重设为出厂默认值。

*1 仅当在播放电台时

故障排除

当本机工作不正常时，请参阅下表。如果您遇到的问题没有列在下表，或下表给出的指导不起作用，请关闭本机，断开电源线，并就近联络 Yamaha 授权的经销商或服务中心。

首先，检查每条缆线的接头是否已牢固地插入每台装置的插孔中。

一般

问题	原因	解决方案
本机在电源打开后立刻进入待机模式。 本机工作不正常。	电源线未正确连接。	请牢固连接电源线。
无法关闭电源。	内部微电脑因外部电击（例如闪电或过量静电）或电源电压较低而突然停止。	按住前面板上的 ϕ 10 秒以上以初始化并重新启动本机。（如果问题仍然存在，请从壁上插座中拔出电源线并在 30 秒或更长时间之后再次插入。）
无声音。	选择了不合适的音频源。	用前面板上的 INPUT 或遥控器上的音频源按钮选择合适的音频源（☞ 第 5、8 页）。
	音箱连接不牢固。	确保牢固连接（☞ 第 9 页）。
	音量最低或静音。	调高音量。
电源突然关闭。	可能设定了睡眠定时器（☞ 第 29 页）。 设定了 Auto Power Off（☞ 第 12 页）。	打开本机并重新播放音频源。
时钟设定被清除。	电源线已断开或出现断电。	连接电源线，并重新设定时钟（☞ 第 27 页）。
仅从一侧的音箱听到声音。	音频源装置或音箱未正确连接。	正确连接音频源装置或音箱缆线（☞ 第 9、19 页）。如果问题仍然无法解决，缆线可能已损坏。
数字或高频设备产生噪音干扰。	本机太靠近数字或高频设备。	将本机远离此种设备放置。
遥控器不工作或功能不正常。	遥控器可能在其操作范围之外操作。	请在操作范围内操作遥控器（☞ 第 12 页）。
	本机的遥控感应器可能暴露于直射阳光或强光下，如逆变式荧光灯。	改变灯光或本机的方向，或者本机的位置。
	电池电量可能已耗尽。	请更换新电池（☞ 第 4 页）。
	本机的感应器和遥控器之间有障碍物。	移除障碍物。

网络

问题	原因	解决方案
网络功能不起作用。	未正确获取网络参数（IP 地址）。	在路由器上启用 DHCP 服务器功能，并在本机上将选项菜单中 [Network Config] 的 [DHCP Enabled] 设定为 [YES]。如想手动配置网络参数，请确保使用的 IP 地址与网络中其他网络装置使用的地址不同（☞ 第 32 页）。
播放停止（歌曲不能持续播放）。	服务器中存在本机不支持的文件。	从正在播放的文件夹中删除本机不支持的文件（包括图片文件或隐藏文件）。
本机检测不到 PC。	媒体共享设置不正确。	配置共享设置，并选择本机作为共享音乐内容的装置（☞ 第 17 页）。
	PC 上安装的某些安全软件阻止本机访问 PC。	检查 PC 上安装的安全软件的设置。
	本机和 PC 未在同一网络中。	请检查网络连接和路由器设置，然后将本机和 PC 连接至同一网络。
	已在本机上启用 MAC 地址过滤器。	在本机选项菜单的 [Advanced Setup] 中，将 [MAC Add.Filter] 设定为 [OFF]（☞ 第 32 页）。
	PC 已连接至支持多 SSID 的路由器的备用 SSID。	当 PC 连接至备用 SSID 时，对连接至首选 SSID 或 LAN 的装置的访问会受限（只有互联网访问可用）。将 PC 连接至首选 SSID。
无法查看或播放 PC 上的文件。	网络装置之间连接了多个路由器（两个路由器）。	暂时断开网络，检查本地网络，并将希望使用的网络装置连接至同一个路由器。
无法查看或播放 PC 上的文件。	本机或媒体服务器不支持这些文件。	请使用本机和媒体服务器都支持的文件格式（☞ 第 40 页）。
本机无法播放某些文件。	您正在尝试播放从 iTunes Store 购买的受到数字版权管理（DRM）的文件。	无法播放从 iTunes Store 购买的受到数字版权管理（DRM）的文件。
无法播放网络电台。	选择的网络电台当前不可用。	电台可能存在网络问题，或者服务可能已停止。请稍后再尝试收听该电台，或选择其他电台。
	选择的网络电台当前没有广播声音。	某些网络电台在每天的特定时段没有广播声音。请稍后再尝试收听该电台，或选择其他电台。
	对网络的访问受到网络装置（如路由器）的防火墙设置的限制。	请检查网络装置的防火墙设置。网络电台只有在通过每个广播电台指定的端口之后才能播放。端口号因电台而异。

问题	原因	解决方案
专用于移动装置的应用程序检测不到本机。	已在本机上启用 MAC 地址过滤器。	在本机选项菜单的 [Advanced Setup] 中，将 [MAC Add.Filter] 设定为 [OFF]，或指定移动装置的 MAC 地址，以允许其访问本机（☞ 第 32 页）。
	本机和移动装置未在同一网络中。	请检查网络连接和路由器设置，然后将本机和移动装置连接至同一网络。
	移动装置已连接至支持多 SSID 的路由器的备用 SSID。	当移动装置连接至备用 SSID 时，对连接至首选 SSID 或 LAN 的装置的访问会受限（只有互联网访问可用）。将移动装置连接至首选 SSID。
	网络装置之间连接了多个路由器（两个路由器）。	暂时断开网络，检查本地网络，并将希望使用的网络装置连接至同一个路由器。
通过网络更新固件失败。	网络连接不稳定。	一段时间之后再次尝试更新。或者通过 USB 存储装置更新固件（☞ 第 30 页）。

iPod

问题	原因	解决方案
无声音。	iPod 未牢固连接。	重新将 iPod 连接至 USB 插孔（☞ 第 15 页）。
	iPod 的软件版本较老。	从 Apple 网站上下载最新的 iTunes 软件，更新 iPod 软件版本。
	iPod 正在连接本机。	请稍候。
iPod 无法通过 iPod、本机或遥控器操作。	本机不支持此 iPod。	使用本机支持的 iPod（☞ 第 39 页）。
	iPod 未牢固连接。	重新将 iPod 连接至 USB 插孔（☞ 第 15 页）。
	iPod 的软件版本较老。	从 Apple 网站上下载最新的 iTunes 软件，更新 iPod 软件版本。如果即使采用了最新软件也无法解决问题，请重设 iPod。
	当 iPod 的显示模式设定为标准模式时，本机或遥控器无法控制 iPod。当处于扩展模式时，iPod 无法运行或控制自身。	检查显示模式。（☞ 第 16 页）
前面板显示屏上不显示播放信息。	iPod 不支持显示播放信息。	只有使用本机支持的 iPod 时，此功能才可用（☞ 第 39 页）。
	显示模式设定为标准模式。	将显示模式更改为扩展模式（☞ 第 16 页）。
iPod 不充电。	iPod 未牢固连接。	重新将 iPod 连接至 USB 插孔（☞ 第 15 页）。
	本机不支持此 iPod。	使用本机支持的 iPod（☞ 第 39 页）。
	本机处于省电待机模式。	通过选项设置将 [Power Saving] 设定为 [Normal]（☞ 第 12 页）。

光盘

问题	原因	解决方案
在装入光盘后不开始播放。 有些按钮操作不起作用。	本机装入的光盘可能不兼容。	使用本机支持的光盘（☞ 第 39 页）。
按本机上的 ▷/□□ 或遥控器上的 ▶ 后播放未立即开始。	光盘可能脏了。	将光盘擦拭干净（☞ 第 39 页）。
	本机装入的光盘可能不受支持。 如果将本机从寒冷处带到温暖处，光盘读取激光头上可能形成了结露。	使用本机支持的光盘（☞ 第 39 页）。 等待一两个小时，直到本机恢复到室温后再重试。

USB 装置

问题	原因	解决方案
本机检测不到 USB 装置。	未将 USB 装置牢固连接至 USB 插孔。 USB 装置的文件系统不是 FAT16 或 FAT32。	关闭本机，重新连接 USB 装置，然后再次打开本机（☞ 第 15 页）。 使用格式为 FAT16 或 FAT32 的 USB 装置。
无法查看 USB 装置中的文件夹和文件。	对 USB 装置中的数据进行了加密保护。	使用没有加密功能的 USB 装置。

FM 接收

问题	原因	解决方案
FM 立体声接收嘈杂。	天线未牢固连接。	确保天线牢固连接，并改变天线的位置（☞ 第 10 页）。
	所选电台可能离您所在的区域很远，或者天线输入不良。	使用市售的室外天线。有关详情，请咨询专业商店。
自动调谐不工作。	所选电台可能离您所在的区域很远，或者天线输入不良。	使用市售的室外天线。有关详情，请咨询专业商店。
		使用手动调谐方法（☞ 第 23 页）。
无法选择预设电台。	预设（记忆）可能已被删除。	重新预设电台（☞ 第 23、24 页）。
即使使用良好的 FM 天线或室外天线仍然有失真，无法获得清晰接收。	可能出现了多路反射或其它无线电干扰。	改变天线的高度、方向或位置。

前面板显示屏上的信息

信息	原因	解决方案
Unknown	从 iPod 到本机的信号路径有问题。	重新连接 iPod。
	本机不支持正在连接的 iPod/USB 装置。	使用本机支持的 iPod/USB 装置（☞ 第 39 页）。
	iPod 的软件版本较老。	从 Apple 网站上下载最新的 iTunes 软件，更新 iPod 软件版本。
Timer not work	本机处于省电待机模式。	通过选项设置将 [Power Saving] 设定为 [Normal]（☞ 第 12 页）。
Overcurrent	本机不支持连接的 iPod/USB 装置。	断开 iPod/USB 装置，关闭本机，然后重新开启。如果这样还不能解决 USB 装置的问题，则不能在本机上播放该装置。
	iPod/USB 装置未正确连接。	
Unplugged	iPod/USB 装置未牢固连接。	断开 iPod/USB 装置并重新连接（☞ 第 15 页）。
No Disc	本机装入的光盘可能不受本机支持。	使用本机支持的光盘（☞ 第 39 页）。
	光盘可能脏了，或者光盘上有异物。	取出光盘并擦拭干净。
	装入的光盘上下颠倒。	装入光盘，使带有标签的一面朝上。
No Songs	光盘中没有可播放的文件。	装入含有可播放文件的光盘（☞ 第 39 页）。
Initializing	本机正在启动。	等到信息消失。如果信息停留时间超过 3 分钟，则关闭本机，然后再次打开。
Loading...	本机正在加载指定的文件 / 内容。	等到本机完成加载。
No Content	所选文件夹中没有可播放的文件。	选择含有可播放文件的文件夹（☞ 第 40 页）。
Not Connected	本机未连接至互联网。	检查互联网连接。
Unsupported	您正在尝试播放本机不支持的文件。	播放本机支持的文件（☞ 第 40 页）。
No Operation	在设定选项菜单时尝试打开光盘托盘。	在完成选项设置后再打开光盘托盘。
Access Denied	拒绝访问 PC。	配置共享设置，并选择本机作为共享音乐内容的装置（☞ 第 17 页）。
	本机无法访问 USB 装置。	关闭本机，然后重新连接 USB 装置。如果问题仍然存在，请尝试连接其他 USB 装置。
	本机无法访问 iPod。	关闭 iPod 后再打开。
Access Error	连接的 iPod 不受本机支持。	请使用本机支持的 iPod（☞ 第 39 页）。
	从网络到本机的信号路径有问题。	确保已打开路由器和调制解调器。 检查本机和路由器（或集线器）之间的连接（☞ 第 11 页）。
Version Error	固件更新失败。	再次更新固件。

支持的装置 / 媒体和文件格式

支持的装置 / 媒体

PC

安装了 Windows Media Player 11 或 Windows Media Player 12 的 PC。

NAS

兼容 DLNA 版本 1.5 的 NAS。

USB 装置

- 本机支持采用 FAT16 或 FAT32 格式的 USB 大容量存储装置（例如闪存或便携式音频播放器）。
- 切勿连接 USB 大容量存储装置以外的装置（例如 USB 充电器或 USB 集线器）、PC、读卡器、外接硬盘等。
- 不能使用经过加密的 USB 装置。

iPod

iPod	iPod touch（第 1 代、第 2 代、第 3 代、第 4 代和第 5 代），iPod nano（第 2 代、第 3 代、第 4 代、第 5 代、第 6 代和第 7 代）
iPhone	iPhone 5、iPhone 4S、iPhone 4、iPhone 3GS、iPhone 3G、iPhone
iPad	iPad（第 4 代）、iPad mini、iPad（第 3 代）iPad 2、iPad

（截至 2013 年 8 月）

注

iPod 经过许可，个人可以自行复制和播放未加密材料或法律上允许复制和播放的材料。侵犯版权是法律所禁止的。

光盘

- 本机可与光盘上或光盘套上印有以下任意标志的音频 CD、CD-R/RW（ISO 9660 格式）一起使用。

音频 CD



CD-R/RW*



* 带有以下任意标志的光盘。
FOR CONSUMER
FOR CONSUMER USE
FOR MUSIC USE ONLY

- 本机可以播放 8-cm 光盘。
将光盘放在光盘托盘的内部凹进区域。

关于光盘的注意事项

- 请勿将以上所述之外的任何其他类型的光盘装入本机。否则，可能损坏本机。
- 无法播放 CD-R/RW，除非经过最终化处理。
- 根据光盘特征或录制状况，有些光盘不能播放。
- 请勿使用任何非标准形状的光盘，如心形光盘。
- 请勿使用表面有很多刮痕或者有裂纹，或者翘曲 / 胶合的光盘。

使用光盘

- 请勿触碰光盘的表面。拿光盘时，请拿在光盘边缘或中心孔处。
- 在光盘标签面上书写时请使用软笔尖的笔。
- 请勿将胶带、密封胶、胶水等弄到光盘上。
- 请勿使用保护盖以防止刮擦。
- 请勿让异物残留在光盘托盘上。
- 请勿一次在本机中装入多张光盘。这可能导致本机和光盘受损。
- 如果光盘变脏，使用清洁、柔软的干布从中心向外缘擦拭干净。请勿使用唱片清洗剂或油漆稀释剂。
- 请勿使用任何镜头清洁剂，否则可能导致故障。
- 请勿将光盘暴露于直射阳光、高温、高湿或多尘环境。
- 当光盘不在使用时，从本机中取出光盘并存放在合适的壳套中。

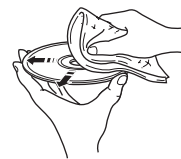

文件格式

本机支持的文件格式如下：

DLNA/USB

- 本机支持播放 WAV（仅限 PCM 格式）、MP3、WMA、MPEG-4 AAC 和 FLAC 文件（仅单声道或双声道音频）。
- 本机兼容的最大采样率为 192 kHz（对于 WAV 和 FLAC 文件）和 48 kHz（对于其他文件）。
- 若要播放 FLAC 文件，则需要安装支持通过 PC 上的 DLNA 共享 FLAC 文件的服务器软件或使用支持 FLAC 文件的 NAS。
- 数字版权管理（DRM）内容无法播放。

光盘

- 本机支持播放最大采样率为 48 kHz 的 MP3 和 WMA 文件。
- 本机兼容 8 至 320 kbps（对于 MP3 文件）和 16 至 320 kbps（对于 WMA 文件）的恒定和可变比特率。
- 本机最多可播放 512 个文件、255 个文件夹（每个文件夹中最多 511 个文件）。
- 数字版权管理（DRM）文件无法播放。



AirPlay 可与 iPhone、iPad 和 iPod touch（iOS 4.3.3 或更新版本）、Mac（OS X Mountain Lion）以及 Mac 和 PC（iTunes 10.2.2 或更新版本）一起使用。

“Made for iPod”、“Made for iPhone”和“Made for iPad”分别表示电子配件是专为连接 iPod、iPhone 或 iPad 而设计的，并且已经得到开发者认证符合 Apple 性能标准。

Apple 对此装置的操作或其在安全和监管标准方面的合规性概不负责。

请注意，对 iPod、iPhone 或 iPad 使用此配件可能会影响无线性能。

AirPlay、iPad、iPhone、iPod、iPod nano、iPod touch 和 iTunes 是 Apple Inc. 在美国和其他国家 / 地区注册的商标。



Fraunhofer
Institut
Integrierte Schaltungen

MPEG Layer-3 音频编码技术已获得 Fraunhofer IIS 和 Thomson 的许可。



本机支持网络连接。



DLNA™ 和 DLNA CERTIFIED™ 是 Digital Living Network Alliance 的商标或注册商标。保留所有权利。未经授权，严禁使用。

Windows™

Windows 是 Microsoft Corporation 在美国和其他国家 / 地区的注册商标。

Internet Explorer、Windows Media Audio 和 Windows Media Player 是 Microsoft Corporation 在美国和 / 或其他国家 / 地区的注册商标或商标。

Android™

Android 和 Google Play 是 Google, Inc. 的商标。

规格

播放器部分

CD	媒体		CD、CD-R/RW
	音频格式		音频 CD、MP3、WMA
	激光	类型	半导体激光 GaAs/GaAlAs
		波长	790 nm
输出功率		10 mW	
iPod (数字连接)	支持的 iPod		请参阅第 39 页。
	支持的 iPhone		
	支持的 iPad		
USB	支持的文件格式		MP3、WMA、MPEG4 AAC、WAV*、FLAC* * 最大 192 kHz/24 比特
AUX 输入	输入接头	AUX1	立体声左 / 右: RCA
		AUX2	3.5 mm 立体声迷你插孔
数字输入	输入接头	DIGITAL IN 1	光纤
		DIGITAL IN 2	同轴
网络	接口		100Base-TX/10Base-T
	网络电台		支持 vTuner 服务
	PC 客户端功能		支持 DLNA 版本 1.5 (DMP/DMR 功能)
	支持的文件格式		MP3、WMA、MPEG4 AAC、WAV*、FLAC* * 最大 192 kHz/24 比特
	AirPlay		支持 AirPlay

调谐器部分

调谐范围 (FM)	87.50 至 108.00 MHz
-----------	--------------------

放大器部分

最大输出功率	32 W + 32 W (6 Ω 1 kHz, 10% THD)
总谐波失真 AUX1 1 kHz/12.5 W	0.05% 以下
EQ 控制	EQ High (高音) / EQ Mid (中音) / EQ Low (低音): ±10 dB
耳机	立体声左 / 右: 3.5mm 立体声迷你插孔 适应阻抗: 16 Ω - 32 Ω

一般

电源	亚洲型号	AC 220-240 V, 50/60 Hz
	台湾型号	AC 110-120 V, 60 Hz
	中国型号	AC 220 V, 50 Hz
	韩国型号	AC 220 V, 60 Hz
功耗	44 W	
待机模式中的功耗	6 W 以下	
省电待机模式中的功耗	0.5 W 以下	
尺寸 (宽 × 高 × 深)	215 × 110 × 288 mm	
重量	2.7 kg	

(截至 2013 年 8 月)
规格时有变更, 恕不另行通知。

목차

소개.....4

- 부속된 액세스리.....4
- 본 설명서에 대하여.....4

각부 명칭.....5

- 전면 패널.....5
- 후면 패널.....6
- 전면 패널 디스플레이.....7
- ▶ 디스플레이 밝기 조정.....7
- 리모컨.....8

준비.....9

- 스피커 연결.....9
- 안테나 연결.....10
- 네트워크에 연결.....11
- 전원 켜기.....12

네트워크 장치 설정.....13

- PC.....13
- NAS.....13
- 모바일 장치.....13

CD 듣기.....14

iPod/USB 장치 듣기.....15

- iPod 재생.....15
- USB 장치 재생.....15

컴퓨터의 곡 듣기.....17

- 음악 파일의 미디어 공유 설정.....17
- PC에서 곡 재생.....18

외부 음원 듣기.....19

재생에 대한 추가 정보.....20

- 임의 재생.....20
- 반복 재생.....20
- 재생 정보.....21
- 음질 조정.....22

FM 라디오 방송 듣기.....23

- FM 방송국 튜닝.....23
- FM 방송국 선국.....23
- 선국한 FM 방송국 선택.....24
- ▶ 선국한 방송국 삭제.....24

인터넷 라디오 청취.....25

AirPlay로 음악 듣기.....26

- iPod 재생.....26
- iTunes 재생.....26

시계 사용.....27

- 시계 설정.....27
- 모닝콜 타이머 설정.....28
- 취침 예약 타이머.....29

펌웨어 업데이트.....30

옵션 설정.....31

- 옵션 메뉴 목록.....32

문제 해결.....33

- 일반사항.....33
- 네트워크.....34
- iPod.....35
- 디스크.....36
- USB 장치.....36
- FM 수신.....37
- 전면 패널 디스플레이의 메시지.....38

지원되는 장치/미디어 및 파일 형식.....39

제품 사양.....41

소프트웨어 관련 정보.....i

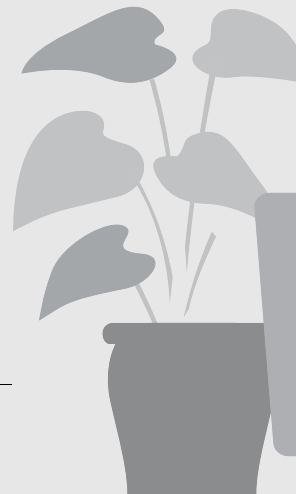

끝내주는 사운드!!

음질이 다른 PC 사운드.....17, 18

고해상도 사운드 재생.....22

언제 어디서나 음악 듣기!

편리한 앱! 내 스마트폰을 리모컨으로 사용18

내 iPhone의 곡을 스피커에서 무선으로 듣기.....26

음악 이외의 기능

다양한 외부 기기(Blu-ray/DVD/모바일 음악 플레이어 등) 연결..... 19

내 오디오 시스템에서 인터넷 라디오 청취..... 25

소개

패키지 내용물과 본 설명서의 유용한 기능을 확인합니다.

부속된 액세서리

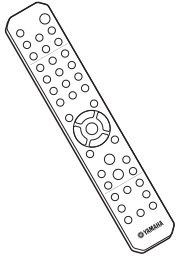

리모컨

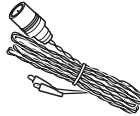

FM 안테나

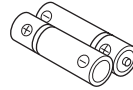

배터리(× 2)
(AA, R6, UM-3)

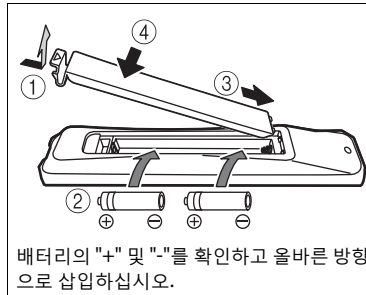

배터리의 "+" 및 "-"를 확인하고 올바른 방향으로 삽입하십시오.

본 설명서에 대하여

- 본 기기의 조작 방법을 주로 리모컨을 사용하여 설명합니다.
- 그림은 기재된 실제 항목과 다를 수도 있습니다.
- 본 설명서에 나오는 "iPod"은 "iPhone" 또는 "iPad"를 포괄하는 것일 수 있습니다.
- 기호:
 - ! 본 기기의 사용 및 기능 제한에 대한 주의 사항을 나타냅니다.
 - 💡 배터리 사용에 대한 보충 설명을 나타냅니다.
 - 👉 해당 참조 페이지를 나타냅니다.

- ! 리모컨의 작동 범위가 줄어들면 배터리를 모두 교체하십시오.

각부 명칭

각부 명칭과 해당 기능을 숙지하십시오.

전면 패널

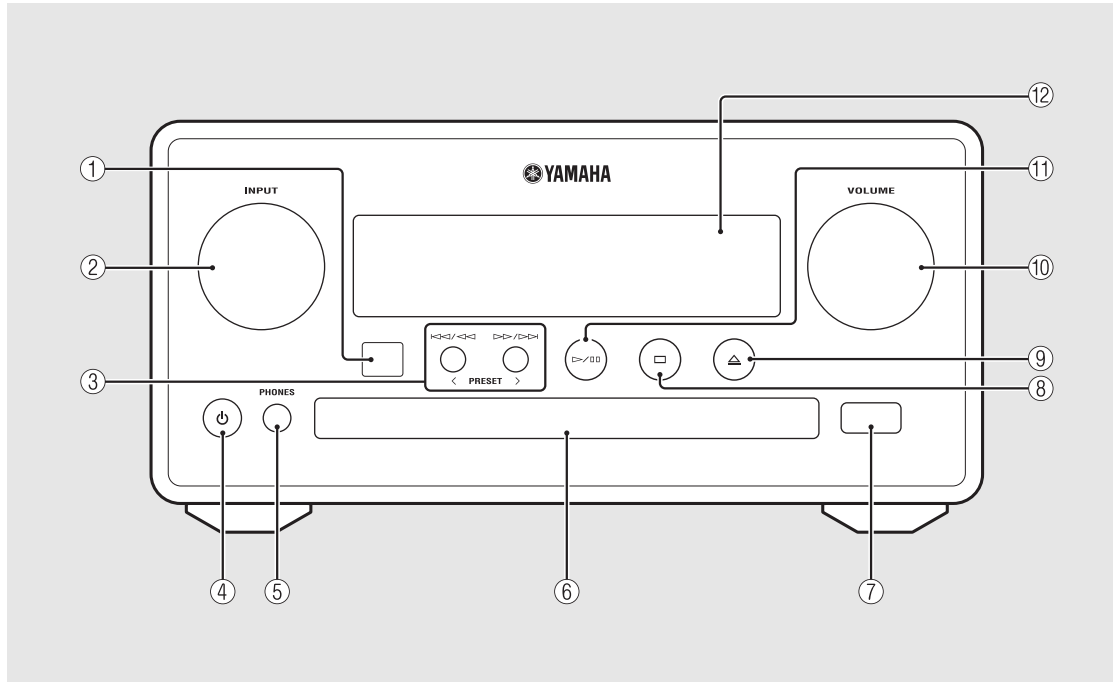

- ① 리모컨 수신기
- ② INPUT
왼쪽 또는 오른쪽으로 돌려 오디오 음원을 변경합니다.
(음원은 전면 패널 디스플레이에 표시됩니다.)
- ③ ⏮/⏪ ⏩/⏭ (☞ 14, 16, 18페이지)
PRESET</>(☞ 24페이지)
- ④ ⏻ (전원)(☞ 12페이지)
- ⑤ PHONES
이 잭에 헤드폰을 연결합니다.
- ⑥ 디스크 트레이(☞ 14페이지)
- ⑦ USB 잭(☞ 15페이지)
- ⑧ □ (중지)(☞ 14, 16, 18, 25페이지)
- ⑨ ≡ (디스크 트레이 열기/닫기)(☞ 14페이지)
- ⑩ VOLUME
볼륨을 조정합니다.
- ⑪ ▷/⏮ (재생/일시 정지)(☞ 14, 16, 18페이지)
- ⑫ 전면 패널 디스플레이(☞ 7페이지)

후면 패널

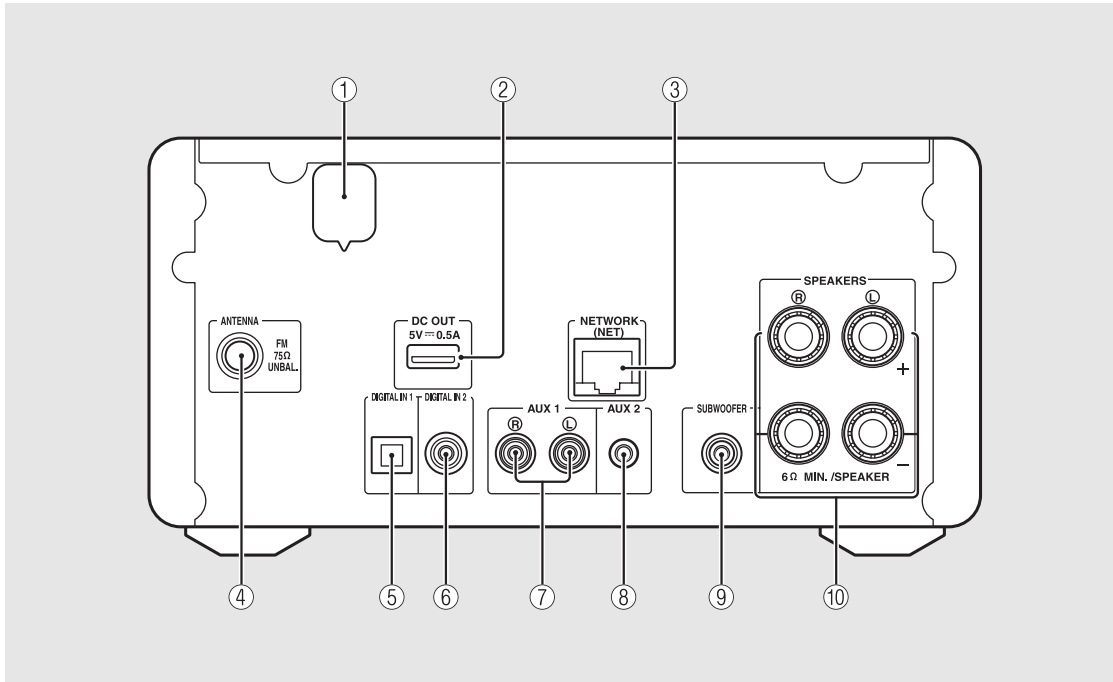

① 전원 케이블(☞ 12페이지)

② DC OUT 단자

이 단자에서 Yamaha AV 액세서리에 전원을 공급합니다. 이 항목을 사용하는 경우 옵션 설정의 [System Config]에서 [Use Accessory]를 [YES]로 설정합니다(☞ 31페이지). 자세한 내용은 액세서리에 부착된 설명서를 참조하십시오.

③ NETWORK 단자(☞ 11페이지)

시판되는 네트워크 케이블을 사용하여 네트워크에 연결합니다.

④ FM 안테나 단자(☞ 10페이지)

⑤ DIGITAL IN 1 단자(광학 입력)(☞ 19페이지)

⑥ DIGITAL IN 2 단자(동축 입력)(☞ 19페이지)

⑦ AUX 1 단자(RCA 입력)(☞ 19페이지)

⑧ AUX 2 단자(미니 잭 입력)(☞ 19페이지)

⑨ SUBWOOFER 단자(☞ 9페이지)

⑩ SPEAKERS 단자(☞ 9페이지)

전면 패널 디스플레이

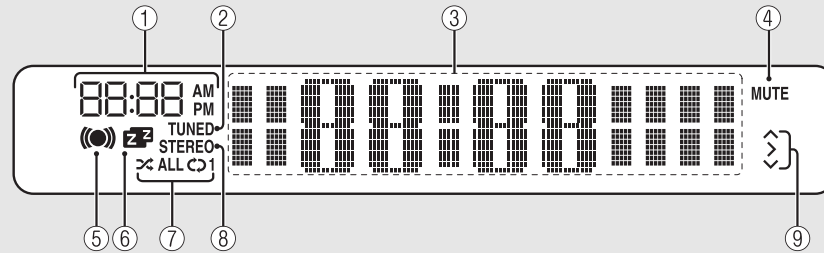

- ① **시계**
전원이 켜진 시간을 표시합니다.
- ② **TUNED 표시등**
기기가 방송국으로 튜닝되면 점등됩니다.
- ③ **다중 정보 표시**
대기 모드일 때 시계, 음악 정보 또는 라디오 주파수 등의 다양한 정보를 표시합니다(영숫자만).
- ④ **MUTE 표시등**
사운드가 음소거되면 점등됩니다(☞ 8페이지).
- ⑤ **모닝콜 타이머 표시등**
모닝콜 타이머를 설정하는 동안 깜박이고 타이머가 설정되면 점등됩니다(☞ 28페이지).

- ⑥ **취침 예약 타이머 표시등**
취침 예약 타이머가 설정되면 점등됩니다(☞ 29페이지).
- ⑦ **임의 재생/반복 표시등**
iPod, CD, USB 장치 또는 컴퓨터를 임의 재생 또는 반복 재생으로 설정하면 점등됩니다(☞ 20페이지).
- ⑧ **STEREO 표시등**
FM 스테레오 방송국에서 강한 신호가 수신되고 있으면 기기가 점등됩니다.
- ⑨ **작동 표시등**
사용 가능한 리모컨의 컨트롤 버튼 ▲/▼/ENTER(☞ 8페이지)를 표시합니다.



디스플레이 밝기 조정

- 리모컨의 **DIMMER** 버튼을 눌러 전면 패널 디스플레이의 밝기를 조정할 수 있습니다(☞ 8페이지).
- 버튼을 누를 때마다 밝게(기본값), 중간, 어둡게로 밝기가 전환됩니다.

리모컨

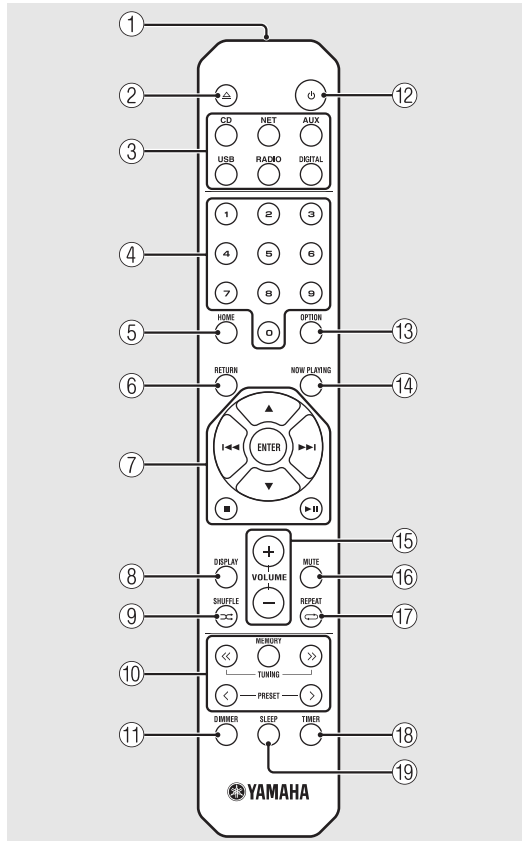

- ① 적외선 신호 송신기
- ② △ (디스크 트레이 열기/닫기)(☞ 14페이지)
- ③ 음원 버튼
재생할 오디오 음원을 전환합니다.
- ④ 숫자 버튼(☞ 14페이지)
- ⑤ HOME(☞ 16, 18, 25페이지)
- ⑥ RETURN(☞ 14, 16, 18, 25페이지)
- ⑦ 오디오 컨트롤, 커서 컨트롤 버튼
(☞ 14, 16, 18, 25페이지)
- ⑧ DISPLAY(☞ 21페이지)
- ⑨ ⇄ (SHUFFLE)(☞ 20페이지)
- ⑩ FM 컨트롤 버튼(☞ 23, 24페이지)
- ⑪ DIMMER(☞ 7페이지)
- ⑫ ⏻ (전원)(☞ 12페이지)
- ⑬ OPTION(☞ 22, 27, 31페이지)
- ⑭ NOW PLAYING(☞ 16, 18, 25페이지)
- ⑮ VOLUME +/-
볼륨을 조정합니다.
- ⑯ MUTE
음소거를 켜거나 끕니다.
- ⑰ ↺ (REPEAT)(☞ 20페이지)
- ⑱ TIMER(☞ 28페이지)
- ⑲ SLEEP(☞ 29페이지)

준비

스피커 또는 안테나를 연결하고 기기를 켭니다.
모든 케이블 연결을 마칠 때까지 기기의 전원 케이블을 연결하지 마십시오.

스피커 연결

- 1 구리선이 노출되도록 스피커 케이블 끝부분의 절연 피복을 벗깁니다.

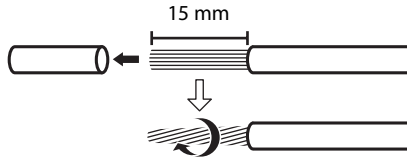

- 2 그림에 나오는 것처럼 스피커를 기기에 연결합니다.

- 스피커와 스피커 케이블을 별도로 준비합니다.
- 스피커 연결은 스피커에 부착된 설명서를 참조하십시오.

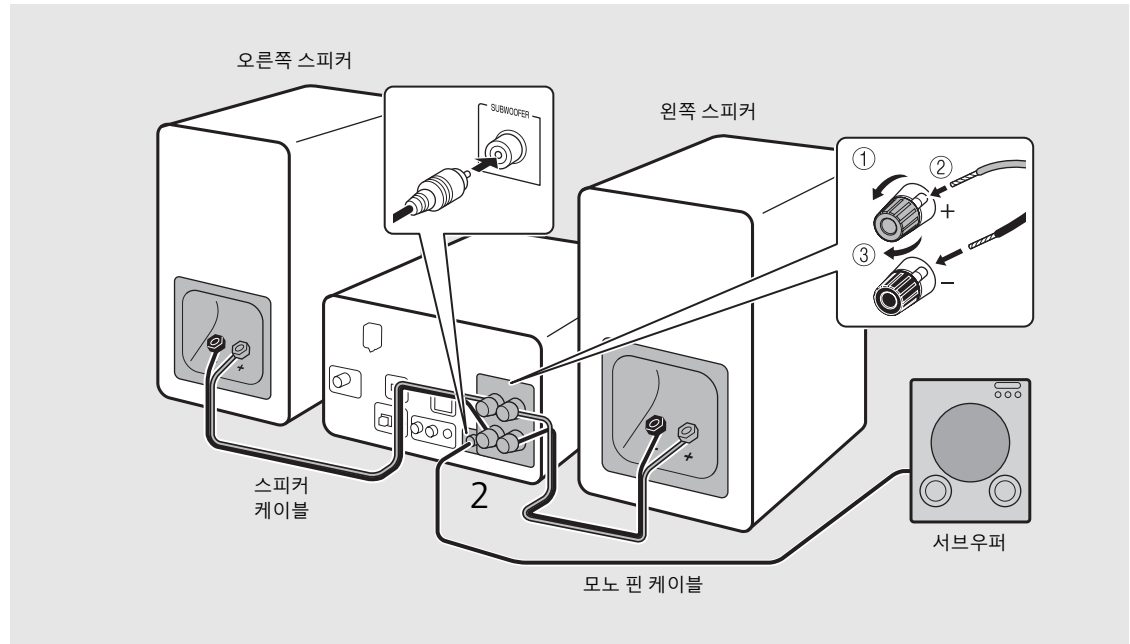

- 피복이 벗겨진 구리선이 서로 닿거나 기기의 금속 부위에 닿지 않도록 주의하십시오. 기기 및/또는 스피커가 손상될 수 있습니다.
- 좌우(L, R) 연결 및 전극(빨간색: +, 검은색: -)이 올바른지 확인하십시오. 연결이 잘못되면 사운드가 부자연스럽게 들릴 수 있습니다.
- 최소 6Ω 임피던스 이상의 스피커를 사용하십시오.
- 내장 앰프가 장착된 서브우퍼를 기기에 연결할 수도 있습니다.

안테나 연결

- 1 부속된 안테나를 기기에 연결합니다.
- 2 핀으로 설치하면 기기의 수신 성능을 높일 수 있습니다.

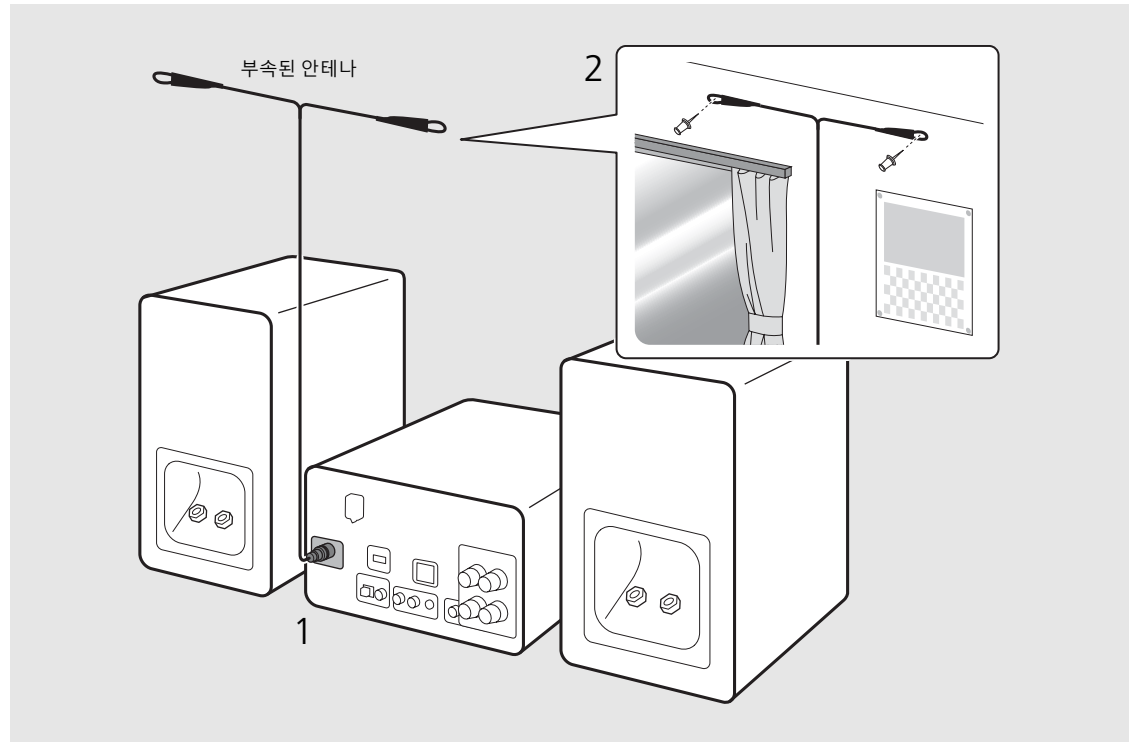

- 그림처럼 안테나를 펼치십시오.
- 부속된 안테나의 라디오 수신 성능이 만족스럽지 못한 경우 시판되는 옥외 안테나를 사용하면 수신 성능이 향상될 수 있습니다.

네트워크에 연결

본 기기를 네트워크에 연결하여 PC, 모바일 장치 및 DLNA* 호환 NAS에 저장된 음악 파일 또는 인터넷의 오디오 콘텐츠를 재생할 수 있습니다. 모바일 장치로 본 기기를 작동할 수도 있습니다.

* Digital Living Network Alliance

오른쪽에 나오는 것처럼 본 기기를 네트워크에 연결합니다.

- 시판되는 STP(차폐형 이중 나선) 네트워크 케이블 (CAT-5 이상, 스트레이트 쓰루 케이블)로 연결합니다.

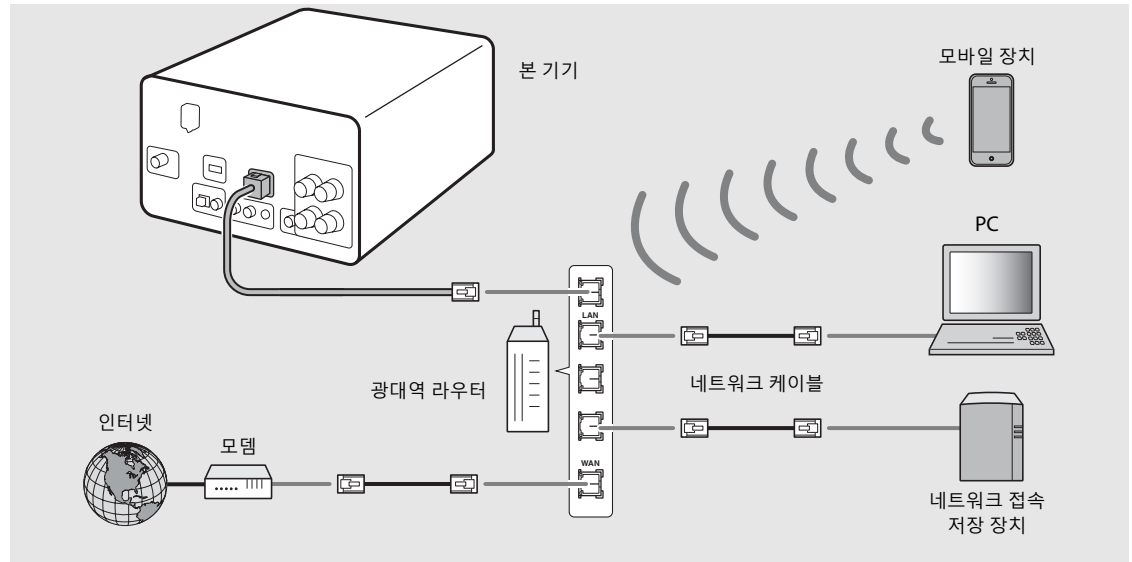





- 인터넷 연결에 대한 자세한 내용은 네트워크 장치의 설명서를 참조하십시오.
- DHCP를 지원하는 라우터를 사용 중이면 본 기기에 대해 네트워크 설정을 구성할 필요가 없습니다. DHCP를 지원하지 않은 라우터를 사용 중인 경우 옵션 설정의 [Network Config]에서 네트워크 설정을 구성하십시오(☞ 31페이지).
- 모바일 장치가 아닌 경우 고음질을 보장하려면 유선으로 연결하는 것이 좋습니다.
- PC에 설치된 일부 보안 프로그램 또는 네트워크 장치(예: 라우터)의 방화벽 설정에 따라 본 기기가 네트워크 장치나 인터넷에 접근하는 것이 차단될 수 있습니다. 이러한 경우에는 보안 소프트웨어 또는 네트워크 장치의 설정을 변경하십시오.
- 서버넷을 수동으로 설정하는 경우 각 서버가 본 기기와 동일한 서버넷에 연결되어야 합니다(☞ 32페이지).

전원 켜기

전원 케이블을 콘센트에 꽂고  을 누릅니다.

- 기기가 켜집니다.
-  을 다시 누르면 장치가 꺼집니다(대기 모드).
- "에코 대기"(기본값)는 본 기기의 전력 소모를 줄이지만 특정 기능이 제한됩니다(오른쪽의 표 참조).

에코 대기 취소

- 1  을 누릅니다.
 - 전면 패널 디스플레이에 옵션 메뉴가 나타납니다.
- 2 에코 대기를 취소합니다.
 - [System Config] - [Power Saving] - [Normal] 순서로 항목을 설정합니다.
 -  로 항목을 변경하고  를 눌러 설정합니다.
- 3  을 눌러 옵션 설정을 마칩니다.

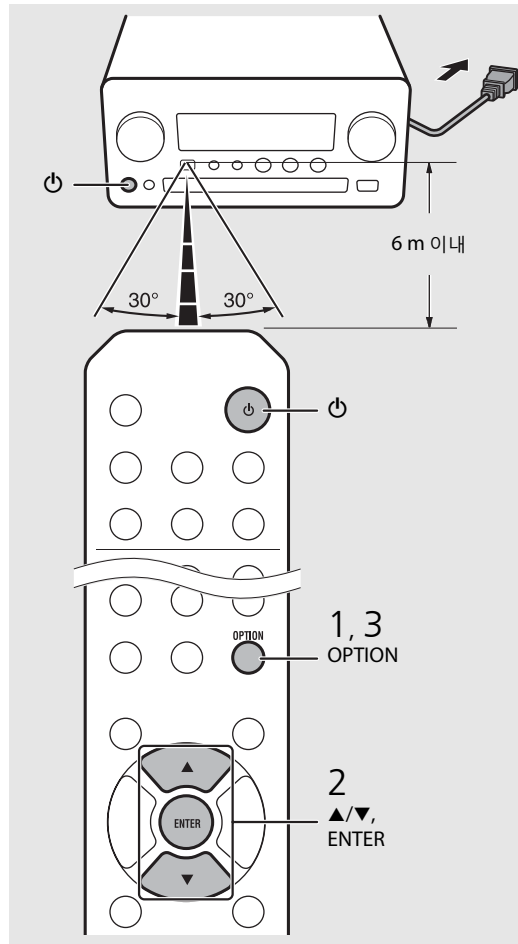

대기/에코 대기의 상태

	대기	에코 대기
iPod/USB 장치 충전	✓	—
모닝콜 타이머 활성화/비활성화*	✓	—
음원 버튼 작동*	✓	✓
CD 로드/꺼내기	✓	✓
AirPlay	✓	—
응용 프로그램으로 전원 켜기	✓	—
시계 표시	✓	—

* 리모컨으로만 작동됨

전원 관련 옵션 메뉴(System Config)

(설정값: 굵은 글꼴: 기본값)

Power Saving

전원 공급 설정을 구성합니다.
(Normal, **Eco**)

[Eco]를 선택한 경우 에코 대기 모드에서 전면 패널 디스플레이에 아무것도 표시되지 않습니다.

Auto Power Off

아무 작업도 수행되지 않을 경우 본 기기가 대기 모드로 진입하는 시간을 설정합니다.
(Timer 2H, Timer 4H, **Timer 8H**, Timer 12H, OFF)

네트워크 장치 설정

PC 또는 NAS에 저장된 음악 파일을 재생하도록 네트워크에 연결된 장치를 구성하거나 본 기기를 제어하도록 모바일 장치를 구성합니다.

PC

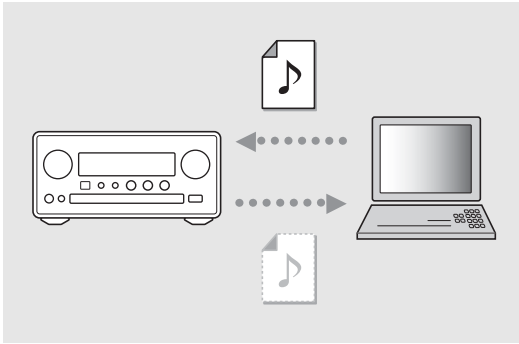

PC의 미디어 공유 설정을 구성합니다
(☞ 17페이지).

NAS

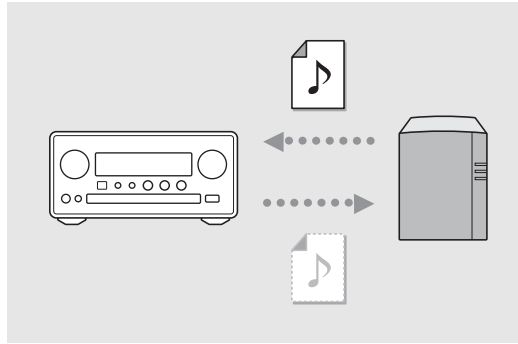

NAS에 액세스하도록 설정을 구성합니다.

- 필요한 경우 NAS의 DHCP 설정을 활성화합니다.
- 자세한 설정은 NAS에 부착된 설명서를 참조하십시오.

모바일 장치

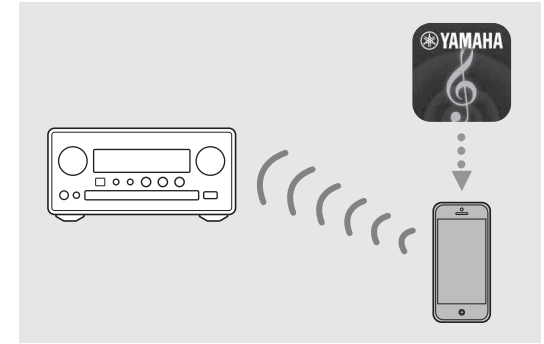









전용 응용 프로그램 "NETWORK PLAYER
CONTROLLER"를 모바일 장치에 설치합니다
(☞ 18페이지).

- 이 응용 프로그램은 iPhone/iPad/iPod touch 및 Android 모바일 장치를 지원합니다.
- 모바일 장치를 본 기기와 동일한 라우터에 연결해야 합니다.

CD 듣기

본 기기로 MP3/WMA 파일이 기록된 오디오 CD와 데이터 CD를 재생할 수 있습니다.
 재생 가능한 CD에 대한 자세한 내용은 "지원되는 장치/미디어"(39페이지)를 참조하십시오.

- 1 INPUT을 돌려 [CD]를 선택합니다. 또는 리모컨의 를 누릅니다.
- 2 디스크 트레이에 CD를 넣습니다.
 - 디스크 트레이를 열거나 닫으려면 을 누릅니다.
- 3 재생이 시작됩니다.
 - 리모컨 기능은 다음과 같습니다.

	MP3/WMA 파일 재생 시 이전 또는 다음 폴더의 첫 번째 파일로 건너뛸니다.
	재생/일시 정지
	중지
	재생 중인 곡의 시작 부분이나 이전 곡으로 건너뛸니다.
	다음 곡으로 건너뛸니다.
	임의 재생을 시작합니다(☞ 20페이지).
	반복 재생을 시작합니다(☞ 20페이지).
1 - 9, 0	곡 번호를 지정합니다.
RETURN	곡 번호를 취소합니다.
ENTER	곡 번호를 적용합니다.

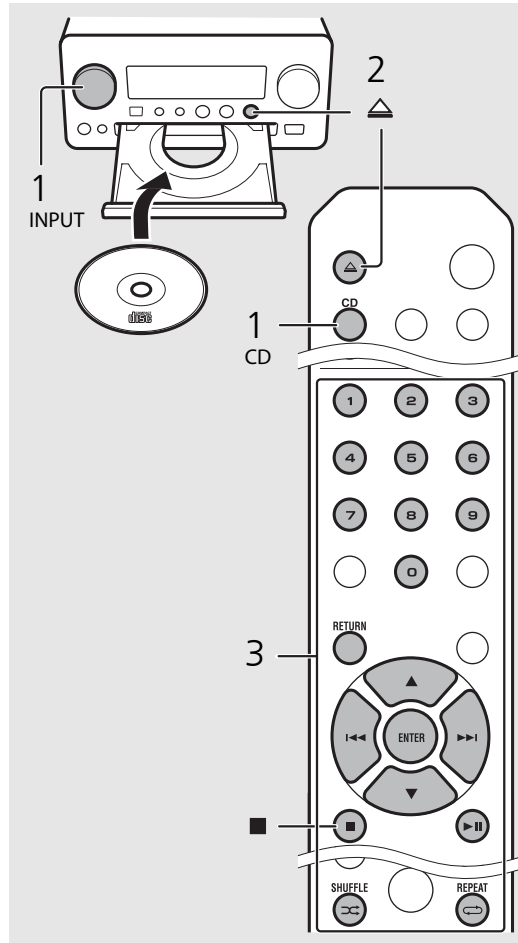

- 데이터 CD의 파일이 영숫자순으로 재생됩니다.
- CD 재생이 중단된 경우 마지막으로 재생한 곡의 시작 부분부터 다시 재생됩니다. 재생이 중단된 동안 을 누르면 다시 재생이 지워집니다.

iPod/USB 장치 듣기

본 기기는 음악 파일이 기록된 iPod 또는 USB 장치를 재생할 수 있습니다.

재생 가능한 iPod/USB 장치에 대한 자세한 내용은 "지원되는 장치/미디어 및 파일 형식"(39페이지)을 참조하십시오.

iPod 재생

- 1 INPUT을 돌려 [USB]를 선택하거나 리모컨의 를 누릅니다.
- 2 iPod을 USB 잭에 연결합니다.
 - iPod에 부착된 USB 케이블을 준비합니다.
 - 음원이 [iPod]으로 변경됩니다.
- 3 재생이 시작됩니다(☞ 16페이지).

USB 장치 재생

- 1 INPUT을 돌려 [USB]를 선택합니다. 또는 리모컨의 를 누릅니다.
- 2 USB 장치를 USB 포트에 연결합니다.
- 3 재생이 시작됩니다(☞ 16페이지).

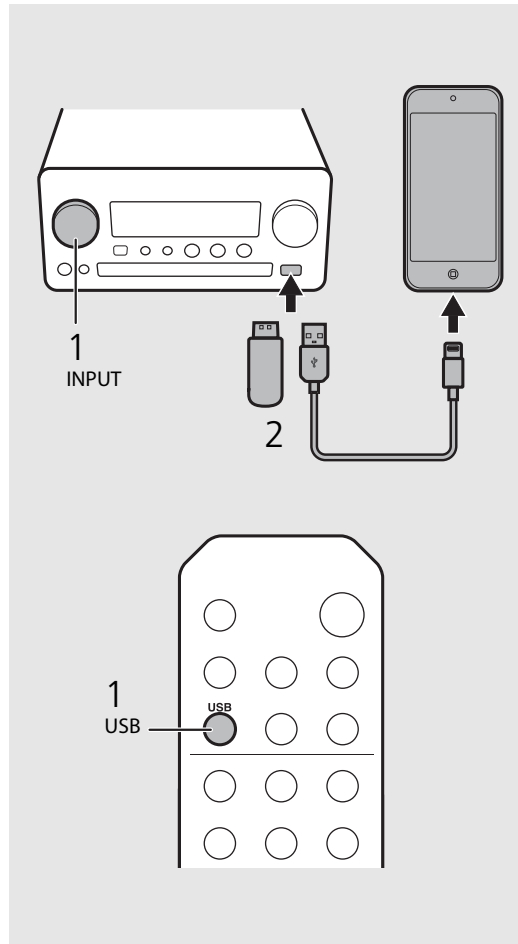







- 일부 iPod/USB 장치는 요구 사항을 충족하더라도 제대로 작동하지 않을 수도 있습니다. 일부 iPod/USB 장치에서는 재생 또는 전원 공급이 보장되지 않습니다.
- Yamaha와 공급업체는 본 기기에 연결된 iPod 또는 USB 장치에 저장된 데이터의 손실에 대해 어떠한 책임도 지지 않습니다. 예방 차원에서 중요한 파일은 백업하는 것이 좋습니다.



- USB 장치를 분리하기 전에 재생을 중지하십시오.
- iPod 또는 USB 장치는 에코 대기 모드일 때 외에는 본 기기에 연결되면 자동으로 충전됩니다.

iPod/USB 장치용 리모컨 조작

	재생 중인 곡의 시작 부분이나 이전 곡으로 건너됩니다(iPod의 경우 빨리 되감으려면 길게 누릅니다).
	다음 곡으로 건너됩니다(iPod의 경우 빨리 감으려면 길게 누릅니다).
	중지
	재생/일시 정지
	임의 재생(↺ 20페이지)
	반복 재생(↻ 20페이지)

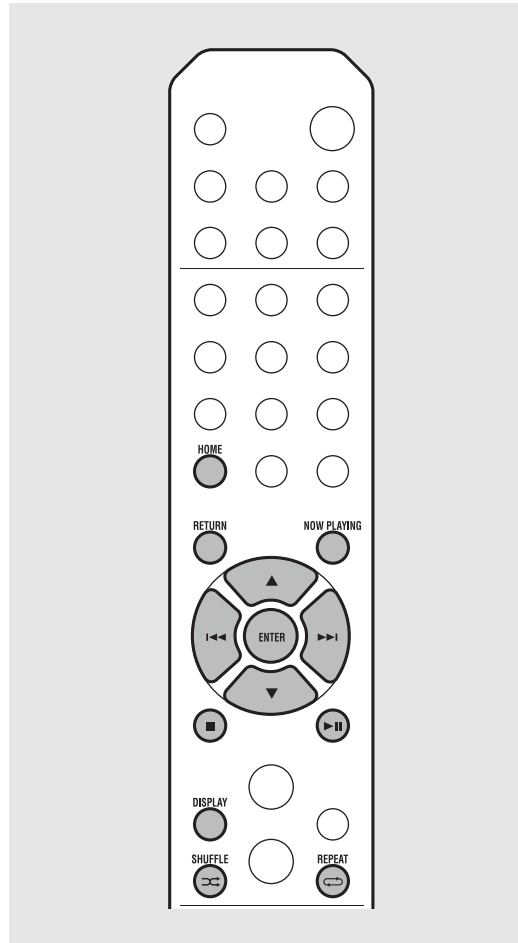

iPod의 정보 표시 전환

Yamaha의 "NETWORK PLAYER CONTROLLER" 응용 프로그램으로 iPod을 작동하면 정보 표시가 확장 모드로 전환됩니다. 정보 표시 모드를 전환하려면 **DISPLAY** 버튼을 길게 누르십시오.

- **표준 모드**(기본값): iPod의 화면을 보면서 iPod을 조작하고 재생할 곡을 선택합니다.
- **확장 모드**: 전면 패널 디스플레이에 나타나는 iPod 정보를 보면서 리모컨을 조작하고(탐색) 재생할 곡을 선택합니다. 리모컨 기능은 다음과 같습니다.

▲/▼	다른 항목을 표시합니다.
ENTER	선택한 항목을 확인하고 다음 레벨로 진행하거나 재생을 시작합니다.
HOME	최상위 항목을 표시합니다.
RETURN	이전 항목으로 돌아갑니다.
NOW PLAYING	탐색을 마치고 재생 콘텐츠 정보를 표시합니다.

컴퓨터의 곡 듣기

본 기기는 네트워크 또는 NAS에 연결된 컴퓨터(서버)에 저장된 MP3, WMA, FLAC(무손실 오디오 데이터 압축 형식) 파일 등의 음악 파일을 재생할 수 있습니다. 전면 패널 디스플레이를 탐색하여 즐겨 듣는 음악 파일을 선택합니다.

▶ 음악 파일의 미디어 공유 설정

본 기기에서 컴퓨터의 음악 파일을 재생하려면 본 기기와 컴퓨터 간에 미디어 공유 설정을 해야 합니다(Windows Media Player 11 이상). 여기에서는 Windows 7에서 Windows Media Player 12로 설정하는 예를 제시합니다.

- 1 PC에서 Windows Media Player 12를 시작합니다.
- 2 "스트림"을 선택한 다음, "미디어 스트리밍 켜기"를 선택합니다.
 - PC의 제어판 창이 나타납니다.
- 3 "미디어 스트리밍 켜기"를 클릭합니다.
- 4 "CRX-N560" 옆의 드롭다운 목록에서 "허용"을 선택합니다.
- 5 종료하려면 "확인"을 클릭합니다.

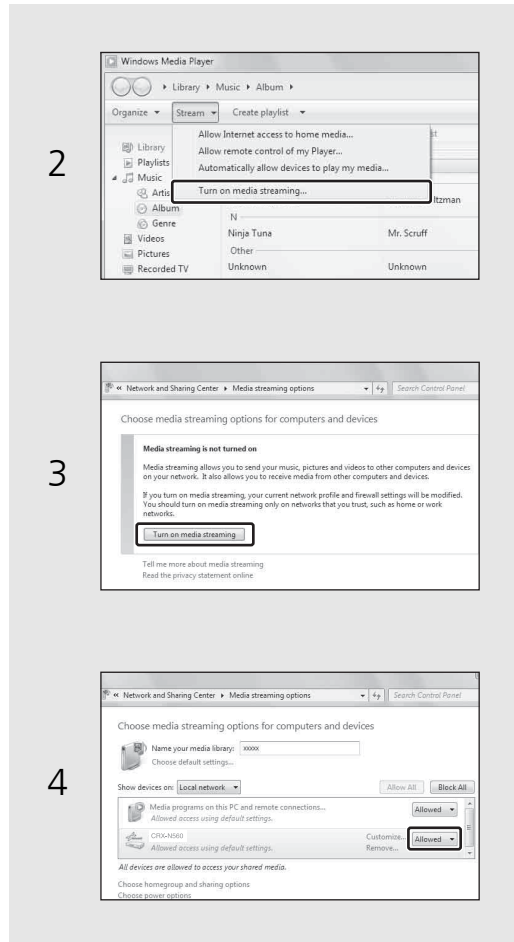

- 미디어 공유 설정에 대한 자세한 내용은 Windows Media Player 도움말을 참조하십시오.

Windows Media Player 11의 경우

- 1 PC에서 Windows Media Player 11을 시작합니다.
- 2 "라이브러리"를 선택한 다음, "미디어 공유를" 선택합니다.
- 3 "내 미디어 공유" 상자를 선택하고 "CRX-N560" 아이콘을 선택한 다음 "허용"을 클릭합니다.
- 4 종료하려면 "확인"을 클릭합니다.

다른 DLNA 서버 소프트웨어가 설치된 PC 또는 NAS의 경우

장치 또는 소프트웨어의 사용 설명서를 참조하여 미디어 공유 설정을 구성하십시오.





PC에서 곡 재생

1 을 반복적으로 누르고 [Server]를 선택합니다.

2 곡을 탐색하고 선택합니다.

▲/▼	다른 항목을 표시합니다.
ENTER	선택한 항목을 확인하고 다음 레벨로 진행하거나 재생을 시작합니다.
HOME	최상위 항목을 표시합니다.
RETURN	이전 항목으로 돌아갑니다.
NOW PLAYING	탐색을 마치고 재생 콘텐츠 정보를 표시합니다.

3 재생을 시작합니다.

	재생/일시 정지
	폴더의 다음 또는 이전 곡으로 이동합니다.
	중지
	임의 재생(☞ 20페이지)
	반복 재생(☞ 20페이지)

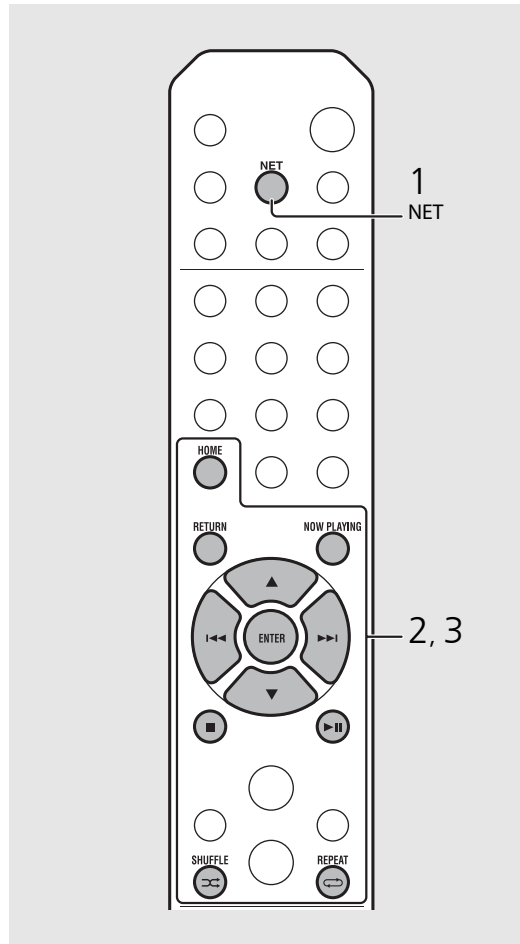

- 재생이 되지 않는 경우 본 기기와 PC(서버)가 동일한 라우터에 연결되어 있는지 확인하십시오 (☞ 11페이지).

모바일 장치에서 조작





모바일 장치에 "NETWORK PLAYER CONTROLLER" 앱을 설치하면 모바일 장치로 본 기기를 조작할 수 있습니다.

- 기능
 - 전원 켜기/끄기, 볼륨 조절 또는 기타 기본 작업
 - 음악 음원 변경
 - 라디오 튜너의 정보 표시
 - 곡 선택, 재생 및 중지
 - 장치에 저장된 곡 재생

앱 또는 최신 정보를 다운로드하려면 App Store 또는 Google Play에 액세스하여 "NETWORK PLAYER CONTROLLER"를 검색하십시오.

외부 음원 듣기

본 기기를 통해 DVD 플레이어 또는 모바일 음악 플레이어 등의 외부 장치를 재생할 수 있습니다. 연결할 장치에 해당하는 단자(DIGITAL IN 1/2 또는 AUX 1/2)를 사용하십시오(☞ 6페이지). 각 외부 장치의 연결은 부속된 설명서를 참조하십시오.

- 1 본 기기의 전원 케이블을 뽑고 외부 장치를 본 기기에 연결합니다.
 - 시판되는 연결용 케이블을 준비합니다.
- 2 기기의 전원 케이블을 콘센트에 다시 꽂고  을 눌러 기기를 켭니다.
- 3 음원을 변경합니다.
 - 재생하려는 외부 장치의 연결 단자에 따라  또는  을 누릅니다.
 - 음원을 AUX1/AUX2(아날로그 입력)로 변경하려면  을 누르고 DIGITAL IN1/DIGITAL IN2(디지털 입력)로 변경하려면  을 누릅니다.
- 4 연결된 외부 장치를 재생합니다.
 - 재생에 대한 자세한 내용은 외부 장치에 부속된 사용 설명서를 참조하십시오.

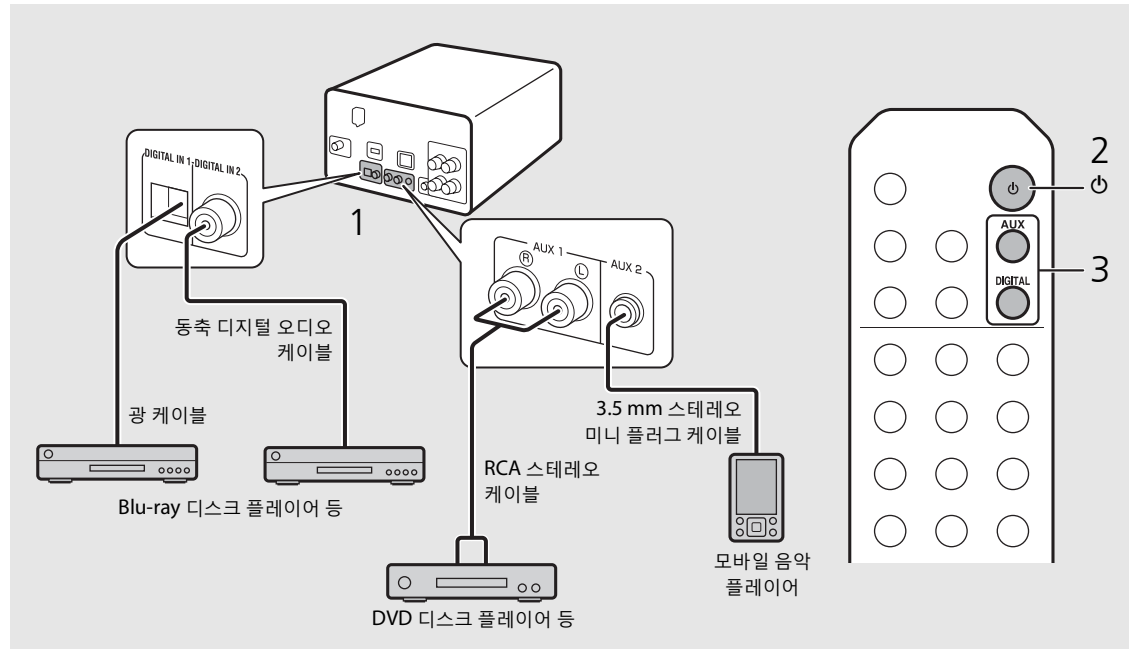

• 연결하기 전에 본 기기와 외부 장치의 볼륨을 줄이십시오. 그렇지 않으면 재생 볼륨이 너무 시끄러울 수 있습니다.

재생에 대한 추가 정보

다양한 곡 순서 또는 음질로 음악을 재생하고 재생 중에 음악 정보를 볼 수 있습니다.
이 단원에서 설명된 기능은 PC(서버), iPod, USB 장치 또는 CD 등 모든 장치에 적용됩니다.

임의 재생

재생 중에  을 누릅니다.

- 버튼을 누를 때마다 전면 패널 디스플레이의 임의 재생 표시등이 아래와 같이 전환됩니다.



 ALL	임의 재생을 수행합니다.*
표시되지 않음	임의 재생을 수행하지 않습니다.

* 임의 재생의 범위는 재생 중인 미디어에 따라 다릅니다.

반복 재생

재생 중에  을 누릅니다.

- 버튼을 누를 때마다 전면 패널 디스플레이의 반복 재생 표시등이 아래와 같이 전환됩니다.

 1	재생 중인 곡을 반복합니다.
ALL 	반복 재생을 수행합니다.*
표시되지 않음	반복 재생을 수행하지 않습니다.

* 반복 범위는 재생 미디어에 따라 다릅니다.

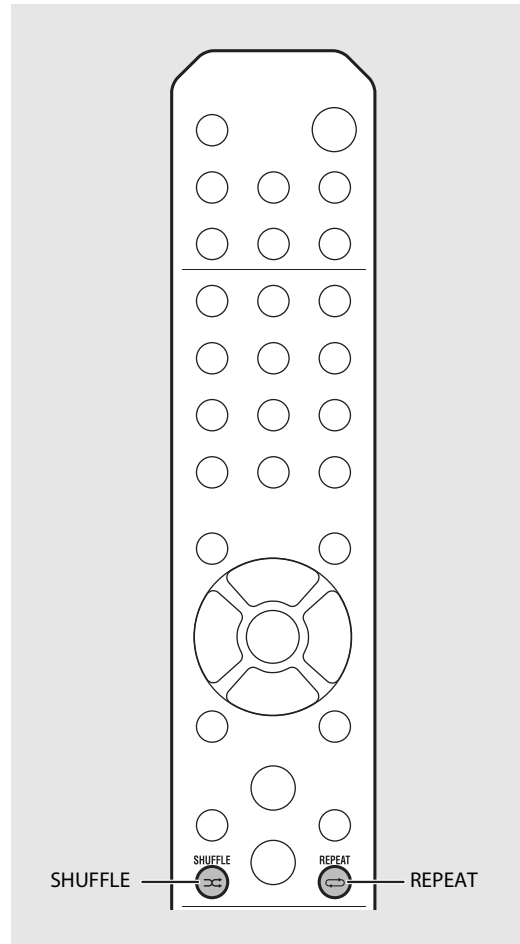

- 임의 재생과 반복 재생은 동시에 수행할 수 없습니다( 1 제외).

재생 정보

전면 패널 디스플레이에서 곡 제목, 경과 시간 등을 볼 수 있습니다.

재생 중에  를 누릅니다.



-  를 누를 때마다 디스플레이가 아래와 같은 순서로 전환됩니다.

USB/iPod/AirPlay/Server	CD
곡 제목*1	재생 시간
앨범 제목	남은 곡 시간*2
아티스트 이름	디스크의 남은 시간*2
재생 시간	곡 제목*1,3
	앨범 제목*3
	아티스트 이름*3

*1 곡 제목을 찾을 수 없으면 파일 제목이 표시될 수도 있습니다.

*2 오디오 CD 재생만 해당.

*3 오디오 CD 재생 시 및 표시할 정보가 있는 경우만 해당.

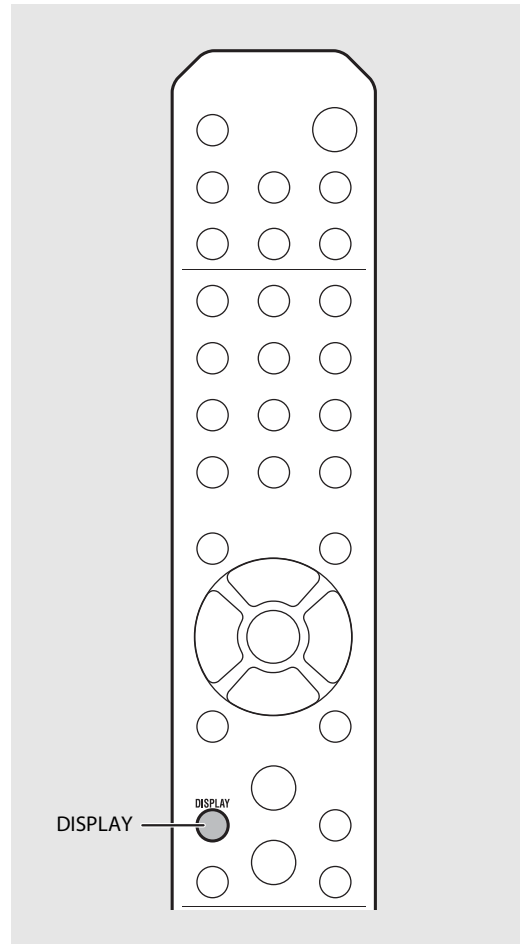

- ! 전면 패널 표시등에는 영숫자 문자만 표시됩니다.
- iPod 디스플레이 모드가 표준 모드인 경우 정보가 표시되지 않습니다(☞ 16페이지).

음질 조정

옵션 설정을 사용하여 음질을 조정할 수 있습니다.

- 1 **OPTION** 을 누릅니다.
 - 전면 패널 디스플레이에 옵션 메뉴가 나타납니다.
- 2 **▲/▼**를 눌러 원하는 항목을 선택하고 **ENTER**를 누릅니다.
- 3 **▲/▼**를 눌러 설정을 변경하고 **ENTER**를 누릅니다.
 - 설정이 적용됩니다.
 - **RETURN** 을 눌러 이전 항목으로 돌아갑니다.
 - 음질 설정을 취소하려면 **OPTION** 을 누릅니다.
 - 다른 항목을 설정하려면 2단계와 3단계를 반복합니다.
- 4 **OPTION** 을 눌러 옵션 설정을 마칩니다.

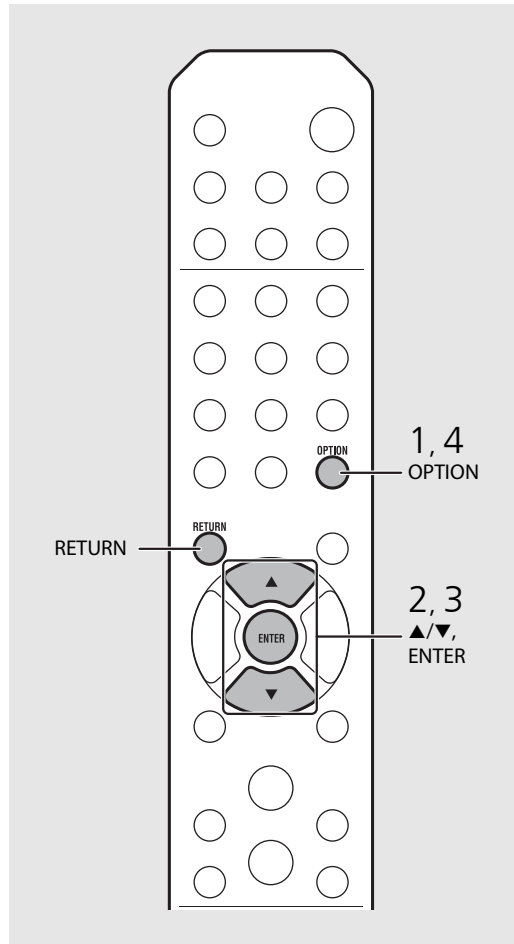

음질과 관련된 옵션 메뉴

(설정값: 굵은 글꼴: 기본값)

Equalizer

낮은 주파수 [EQ Low], 중간 주파수 [EQ Mid] 및 높은 주파수 [EQ High]를 조정합니다. 이 설정은 헤드폰 사용 시에도 적용됩니다.
(-10 ~ **0** ~ +10)

Balance

왼쪽 및 오른쪽 스피커의 볼륨 밸런스를 조정합니다. 이 설정은 헤드폰 사용 시 적용되지 않습니다.
(Lch. +10 ~ **-CENTER-** ~ Rch. +10)

Music Enhancer

압축을 통해 손실된 음악적 요소를 재생성합니다.
(ON, **OFF**)
FLAC 또는 WAV 등의 고품질 음원 재생 시 [OFF]로 설정하는 것이 좋습니다. 압축되지 않은 오디오 CD 재생 시 이 기능이 [ON]으로 설정되어 있더라도 사용할 수 없습니다.

FM 라디오 방송 듣기

FM 라디오 방송을 들으려면 부착된 안테나를 연결하십시오.
본 기기에 안테나를 연결하는 방법은 "안테나 연결"(10페이지)을 참조하십시오.

FM 방송국 튜닝

- 1 **RADIO** 버튼을 누릅니다.
- 2 **TUNING** (◀/▶) 버튼을 길게 누릅니다.
 - 자동 튜닝이 시작된 다음 방송국이 튜닝되면 자동으로 중지됩니다.

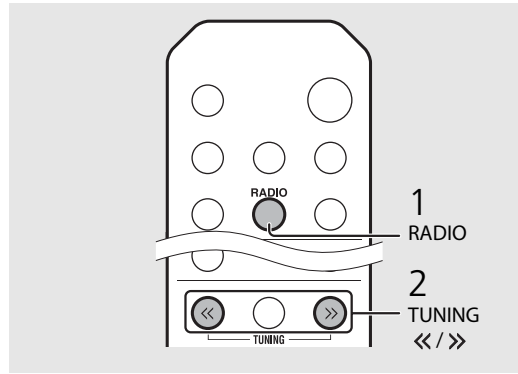

- 방송 수신이 약하면 **TUNING** (◀/▶) 버튼을 반복적으로 눌러 수동으로 방송국을 튜닝할 수 있습니다.

FM 방송국 선국

자동 선국

수신 성능이 좋은 방송국을 자동으로 튜닝하고 선국합니다.

- 1 **RADIO** 버튼을 누릅니다.
- 2 **MEMORY** 버튼을 2초 이상 누릅니다.
- 3 **MEMORY** 버튼을 누릅니다.
 - 자동 선국이 시작되고, 완료되면 전면 패널 디스플레이에 "Completed!"가 나타납니다.

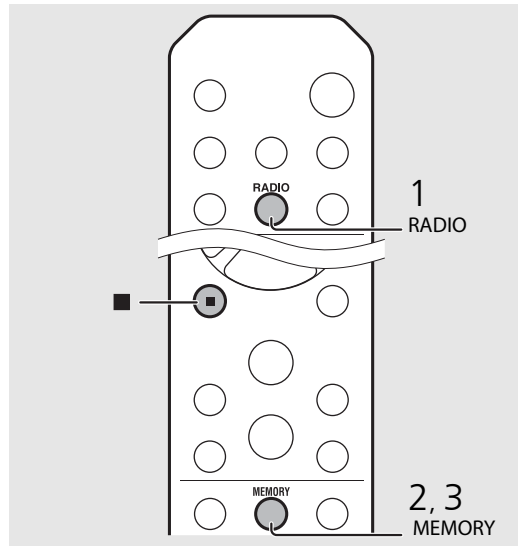

- 자동 선국은 현재 저장된 모든 방송국을 새로 저장된 방송국으로 대체합니다.



- 최대 30개의 FM 방송국을 선국할 수 있습니다.
- 자동 선국을 취소하려면 ■ 버튼을 누릅니다.

수동 선국

1 저장하려는 방송국을 튜닝합니다
(☞ 23페이지).

2  를 누릅니다.

- 전면 패널 디스플레이에서 선국 번호가 깜박입니다.



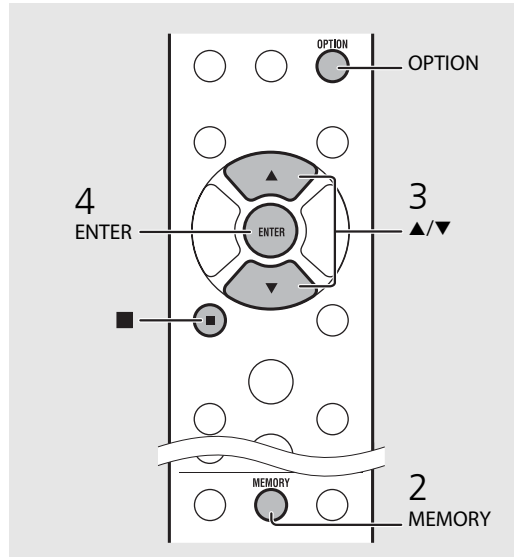

3 ▲/▼를 눌러 원하는 선국 번호를 선택합니다.

4  를 눌러 선국합니다.



▶ 선국한 FM 방송국 선택

1  를 누릅니다.

2 PRESET  /  을 눌러 방송국을 선택합니다.

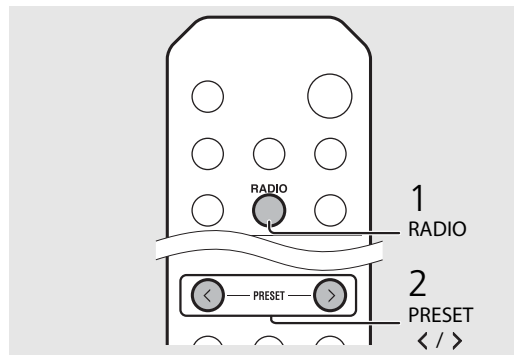

- 수동 선국 설정을 취소하려면  을 누릅니다.

선국한 방송국 삭제

옵션 설정을 사용하여 선국한 방송국을 삭제합니다.

1 음원이 FM이면  을 누릅니다.

- 전면 패널 디스플레이에 옵션 메뉴가 나타납니다.
- 선국한 방송국을 취소하려면  을 누릅니다.

2 ▲/▼를 눌러 [Preset Delete]를 선택하고  를 누릅니다.

3 ▲/▼를 눌러 삭제할 선국 번호를 선택합니다.

4  를 누릅니다.

- 선국한 방송국이 삭제되고 전면 패널 디스플레이에 [Deleted!]가 나타납니다.

5  을 눌러 옵션 설정을 마칩니다.

인터넷 라디오 청취

인터넷을 통해 전세계 라디오 방송을 들을 수 있습니다.
기기가 인터넷에 제대로 연결되었는지 확인하십시오(☞ 11페이지).

- 1 **NET** 버튼을 반복적으로 눌러 [Net Radio]를 선택합니다.
- 2 인터넷을 검색하여 라디오 방송국을 선택합니다.



• 리모컨 기능은 다음과 같습니다.

▲/▼	기타 항목을 표시합니다.
ENTER	선택한 항목을 확인하고 다음 레벨로 진행하거나 재생을 시작합니다.
HOME	최상위 항목을 표시합니다.
RETURN	이전 항목으로 돌아갑니다.
NOW PLAYING	탐색을 마치고 재생 콘텐츠 정보를 표시합니다.

- 3 재생이 시작됩니다.

• 재생을 중지하려면 **■** 버튼을 누릅니다.

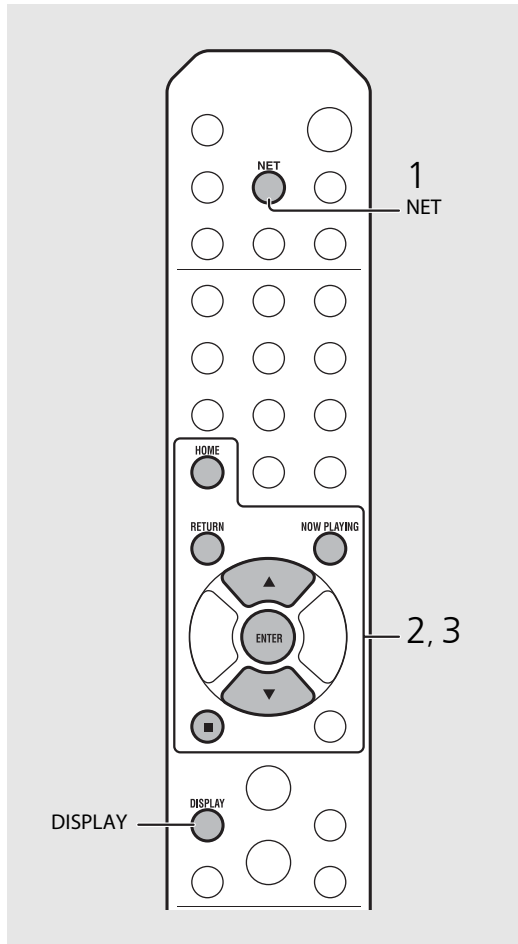

- 인터넷 라디오가 재생되는 동안 **DISPLAY** 버튼을 눌러 재생 정보를 볼 수 있습니다. 버튼을 누를 때마다 정보가 아래와 같이 변경됩니다.

라디오 방송국 이름(기본값)

곡 제목

재생 시간



- 기기에서 [Net Radio]를 음원으로 선택한 다음 PC에서 웹 브라우저로 다음 웹사이트에 액세스하여 즐겨 듣는 인터넷 라디오 방송국을 "즐거찾기" 폴더에 등록할 수 있습니다.
<http://yradio.vtuner.com/>

이 기능을 사용하려면 개인 계정을 만들기 위해 기기의 vTuner ID와 이메일 주소가 필요합니다. 옵션 설정의 [Network Info](☞ 32페이지)에서 vTuner ID(기기의 MAC 주소)를 확인할 수 있습니다.

AirPlay로 음악 듣기



AirPlay 기능을 사용하면 기기에서 네트워크를 통해 무선으로 iTunes/iPod 음악을 재생할 수 있습니다. 기기와 PC 또는 iPod이 동일한 라우터에 연결되었는지 확인하십시오(☞ 11페이지).

iPod 재생

- 1 기기를 켜고 iPod에서 재생 화면을 표시합니다.
 - iPod이 기기를 인식하면 iPod 화면에  이 나타납니다.
- 2  을 누르고 기기의 이름을 선택합니다.
 - 음원이 자동으로 [AirPlay]로 전환되고 재생이 시작됩니다(에코 대기 모드 제외).



iTunes 재생

- 1 기기를 켜고 iTunes를 시작합니다.
 - iTunes가 기기를 인식하면 iTunes 화면에  이 나타납니다.
- 2  을 클릭하고 기기의 이름을 선택합니다.
 - 음원이 자동으로 [AirPlay]로 전환됩니다(에코 대기 모드 제외).
- 3 iTunes로 곡을 재생합니다.

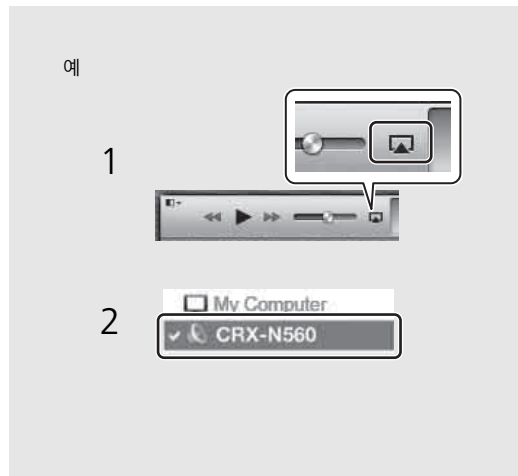

- ! iTunes/iPod 컨트롤을 사용하여 볼륨을 조절할 경우 볼륨이 지나치게 커질 수 있습니다. 이 경우 본 기기나 스피커가 손상될 수 있습니다. 재생 중에 볼륨이 커지면 즉시 iPod/iTunes에서 재생을 중지하십시오.
- 💡 기기와 리모컨을 사용하여 곡 재생, 일시 정지, 중지 및 건너뛰기를 수행할 수 있습니다.
- 리모컨으로 iTunes 재생을 제어하려면 미리 원격 스피커의 iTunes 제어 기능을 활성화하도록 iTunes 기본 설정을 구성해야 합니다.

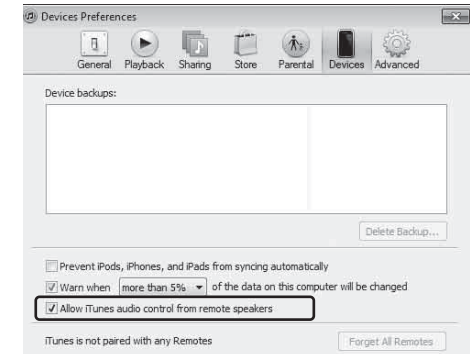

AirPlay 소거

- iPod/iTunes 화면에서  을 누르고/클릭하고 스피커 목록에서 CRX-N560 이외의 다른 장치를 선택합니다. 또는 음원을 AirPlay가 아닌 다른 음원으로 변경합니다.

시계 사용

시계를 설정하면 즐겨 듣는 곡이나 라디오 프로그램을 알람으로 재생할 수 있습니다.

시계 설정

- 1 **OPTION** 을 누릅니다.
 - 전면 패널 디스플레이에 옵션 메뉴가 나타납니다.
- 2 **▲/▼**로 [System Config]를 선택하고 **ENTER**를 누릅니다.
- 3 **▲/▼**로 [Clock Setting]을 선택하고 **ENTER**를 누릅니다.



- 4 날짜와 시간을 설정합니다.
 - **▲/▼**로 설정을 변경하고 **ENTER**를 눌러 확인합니다.
 - 연, 월, 일, 시, 분 순서로 절차를 수행합니다.
 - 설정을 취소하려면 **RETURN** 을 누릅니다.
 - 설정이 완료되면 [Completed!]가 나타납니다.
- 5 **OPTION** 을 눌러 옵션 설정을 마칩니다.

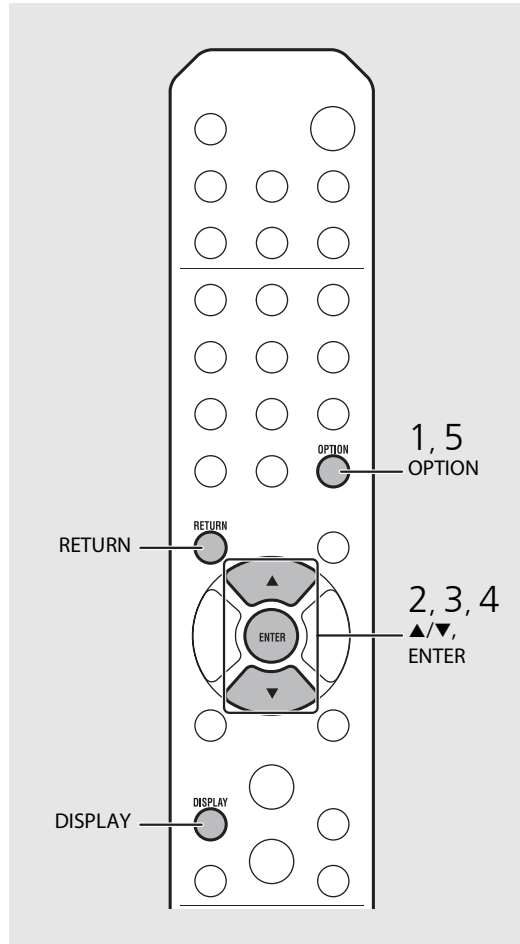

- ! • 콘센트에서 전원 케이블을 뽑은 상태로 1주일 정도 지나면 시계 설정이 지워집니다. 시계를 다시 설정하십시오.
- 💡 • 시계를 설정할 때 **DISPLAY** 버튼을 누르면 시계 형식(12시간/24시간)을 변경할 수 있습니다.

모닝콜 타이머 설정



설정된 시간에 음악 또는 비프음이 시작됩니다.

1  를 길게 누릅니다.

- 전면 패널 디스플레이에 [Timer Setting] 및 시간이 나타나고  및 시간이 깜박입니다.



2 다음 항목 ① ~ ③을 설정합니다.

- ▲/▼를 눌러 설정값을 선택하고  를 눌러 항목을 설정합니다.
- 디스플레이가 다음 항목으로 전환됩니다.
- 설정을 취소하려면  을 누릅니다.

① 시작 시간

시와 분을 설정합니다.

② 볼륨

[5] ~ [59] 및 [MAX]로 설정할 수 있습니다.

③ 반복



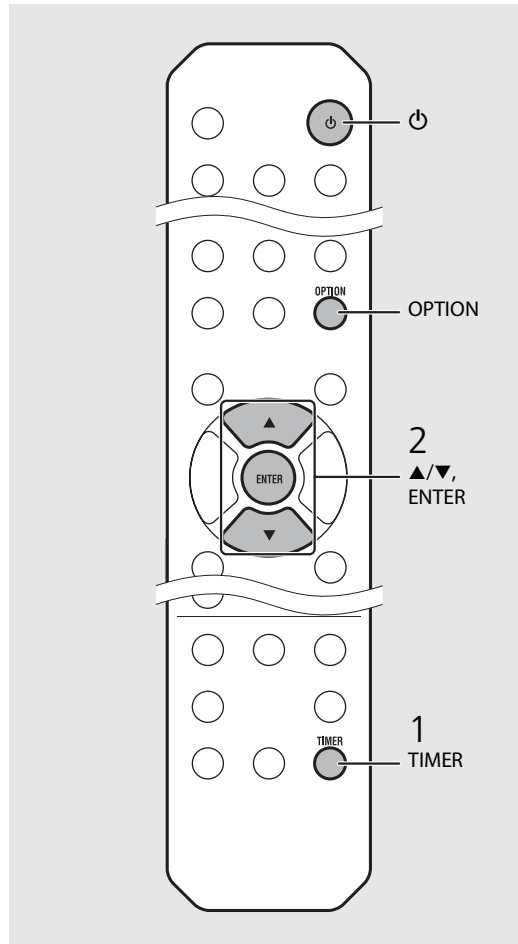

Repeat: 매일 설정한 시간에 모닝콜 타이머가 울립니다.

No Repeat: 모닝콜 타이머가 1회 울립니다.



- 모닝콜 타이머를 설정하기 전에 시계를 설정하십시오.
- [Power saving]이 [Eco]로 설정된 경우 모닝콜 타이머를 사용할 수 없습니다. [Normal]로 설정하십시오(☞ 12페이지).



- 옵션 설정을 사용하여 모닝콜 타이머를 설정할 수도 있습니다.
 - 1  을 누릅니다.
 - 전면 패널 디스플레이에 설정 메뉴가 나타납니다.
 - 2 ▲/▼를 눌러 [Timer Setting]을 선택하고  를 누릅니다.
 - 3 왼쪽의 2단계를 수행합니다.
 - 4  을 눌러 옵션 설정을 마칩니다.
 - 5 음악 음원을 설정하고 음원을 재생하고  을 누릅니다.

다음 페이지로 계속 ➡

- 설정이 완료되면 전면 패널 디스플레이에 [Completed!]가 나타나고 (●)이 점등됩니다.



3 (●)을 누릅니다.

- 기기가 대기 모드로 진입하고 설정된 시간에 비프음이 울립니다.
- 설정된 시간에 음악을 재생하려면 이 단계에서 (●)을 누르기 전에 오디오 음원을 선택하고 재생하십시오. 오디오 음원에 대한 자세한 내용은 오른쪽의 팁 하단부(*)를 참조하십시오.

취침 예약 타이머

기기가 자동으로 대기 모드로 들어가는 간을 설정할 수 있습니다.

(SLEEP)을 여러 번 눌러 시간을 선택합니다.

- 30/60/90/120분 또는 OFF 중에서 시간을 선택할 수 있습니다.
- (Z) 시간이 선택된 후에 잠깐 점등되고 취침 예약 타이머가 설정됩니다.
- 취침 예약 타이머를 취소하려면 (SLEEP)을 다시 누릅니다.

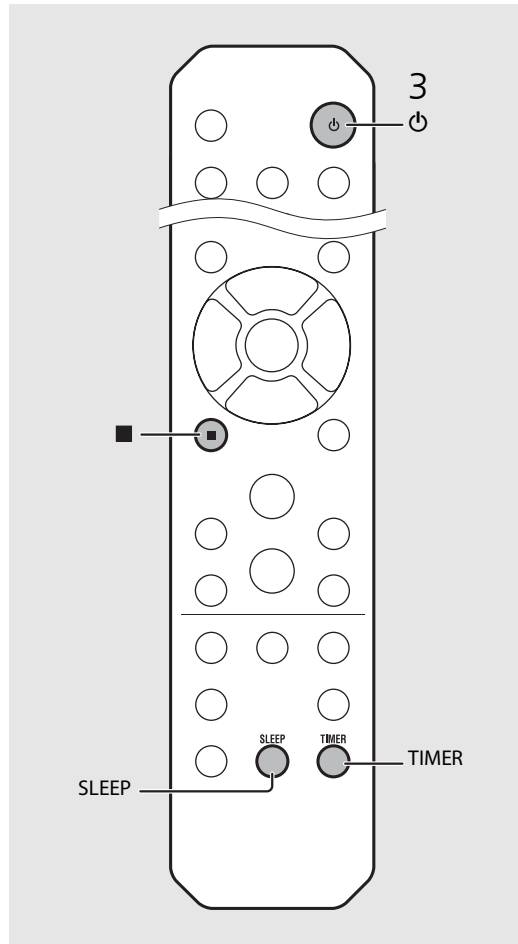

- 모닝콜 타이머가 설정된 후에 기기에서 음원이 제거되면 시작 시 기기에서 비프음이 울립니다.
- 시작 시 음악 음원이 재생되면 (●)이 깜박이고 재생이 계속됩니다.
- 모닝콜 타이머 설정 후 기기가 켜지면 **TIMER** 버튼을 눌러 활성화하거나 비활성화할 수 있습니다.
- 비프음을 중단하려면 ■ 또는 (●)을 누르십시오. 누르지 않으면 60분 후에 멈춥니다.

* 음악 음원이 AUX, Server, DIGITAL IN 또는 AirPlay로 설정된 경우 시작 시 기기에서 비프음이 울립니다.

펌웨어 업데이트

새 펌웨어가 출시되면 전면 패널 디스플레이에 현재 펌웨어를 업데이트하라는 메시지가 나타납니다(기기가 인터넷에 연결된 경우에만). 이 페이지에 옵션 설정을 사용하여 네트워크를 통해 업데이트하는 방법이 나타납니다.

- 1 **OPTION** 을 누릅니다.
 - 전면 패널 디스플레이에 옵션 메뉴가 나타납니다.
- 2 **▲/▼**로 [System Config]를 선택하고 **ENTER**를 누릅니다.
- 3 **▲/▼**로 [Firm Update]를 선택하고 **ENTER**를 누릅니다.
- 4 **▲/▼**로 [Network]를 선택하고 **ENTER**를 누릅니다.
 - 업데이트가 시작됩니다.



- 업데이트가 완료되면 "Update success.", "Please..." 및 "power off!" 순서로 메시지가 나타납니다.
- 5 콘센트에서 전원 케이블을 분리한 다음 약 30초 후에 다시 연결합니다.
 - 업데이트가 적용됩니다.

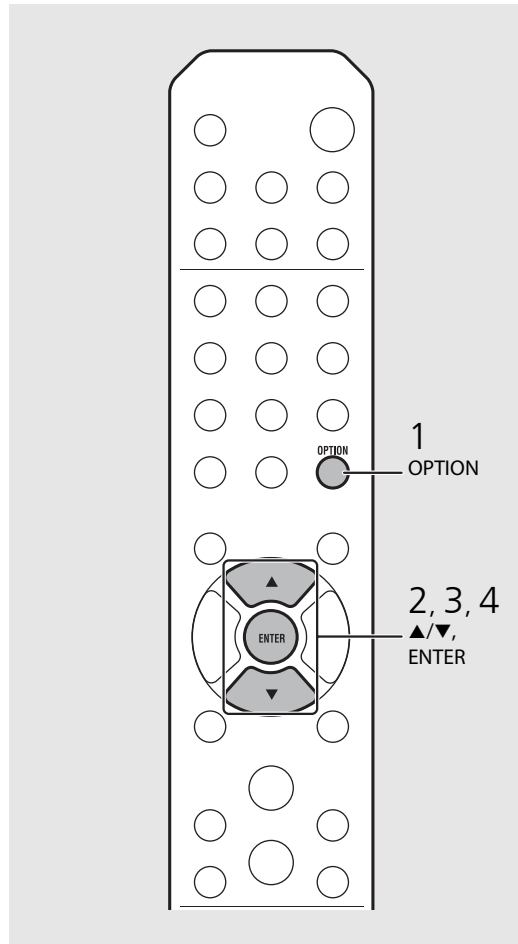

- ! • 업데이트 도중에 기기를 작동하거나 전원 케이블 및 네트워크 케이블을 분리하지 마십시오.
- 💡 • 전면 패널 디스플레이에 업데이트 확인 메시지가 한 번 나타난 후에는 업데이트를 수행하지 않아도 다시 나타나지 않습니다. 그러나 잠시 콘센트에서 전원 케이블을 뽑은 후에 기기를 켜면 메시지가 나타납니다.
- 인터넷 속도가 빠르지 않거나 기기가 무선 네트워크 어댑터를 통해 무선으로 연결된 경우 무선 연결 상태에 따라 네트워크 업데이트를 수행하지 못할 수도 있습니다. 이런 경우에는 USB 메모리 장치를 사용하여 다시 시도하거나 펌웨어를 업데이트하십시오. 펌웨어는 Yamaha 웹사이트에서 다운로드할 수 있습니다.

USB 메모리 장치를 사용하여 펌웨어를 업데이트하려면

- USB 메모리 장치로 펌웨어를 다운로드하고 해당 USB 메모리 장치를 본 기기의 USB 잭에 연결할 수 있습니다.
- 4단계에서 [USB]를 선택하고 **ENTER** 버튼을 눌러 업데이트를 시작합니다.

옵션 설정

옵션 설정을 통해 기기를 사용하기에 적합한 방식으로 구성할 수 있습니다.

- 1 **OPTION** 을 누릅니다.
 - 전면 패널 디스플레이에 옵션 메뉴가 나타납니다(☞ 32페이지).
- 2 **▲/▼**로 원하는 옵션 메뉴를 선택하고 **ENTER** 를 누릅니다.



- 3 **▲/▼**로 설정을 변경하고 **ENTER** 를 누릅니다.
 - 하위 메뉴를 설정해야 하는 경우 3단계를 반복합니다.
 - **RETURN** 을 눌러 설정을 취소하고 이전 레벨로 돌아갑니다.
 - 다른 메뉴 항목을 설정하려면 2단계와 3단계를 반복합니다.
- 4 **OPTION** 을 눌러 옵션 설정을 마칩니다.

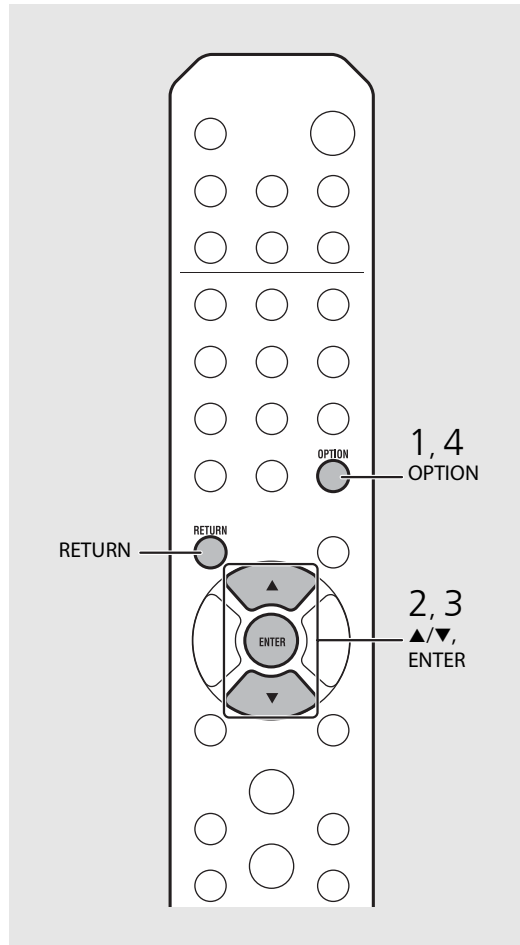

- 옵션 메뉴에서 [Advanced Setup]을 설정하려면 기기의 **□**(중지 버튼)을 누른 상태로 리모컨의 **OPTION** 버튼을 누른 다음 3단계로 진행합니다.

음선 메뉴 목록

메뉴	하위 메뉴	기본값	기능
Preset Delete*1 (☞ 24페이지)			선국 방송국을 삭제합니다.
Equalizer (☞ 22페이지)	EQ Low	0	낮은 주파수를 조정합니다.
	EQ Mid	0	중간 주파수를 조정합니다.
	EQ High	0	높은 주파수를 조정합니다.
Balance (☞ 22페이지)		CENTER	왼쪽 및 오른쪽 스피커의 볼륨 밸런스를 조정합니다.
Music Enhancer (☞ 22페이지)		OFF	Music Enhancer를 활성화/비활성화합니다.
Timer Setting (☞ 28페이지)			모닝콜 타이머를 설정합니다.
Network Info	Network Status		기기와 네트워크의 연결 상태를 표시합니다.
	MAC Address		MAC 주소를 표시합니다.
	System ID		시스템 ID를 표시합니다.
	Network Name		네트워크에 나타나는 기기의 이름을 표시합니다.

메뉴	하위 메뉴	기본값	기능
Network Config	DHCP Enabled	YES	DHCP를 활성화/비활성화합니다.
	IP Address	0.0.0.0	IP 주소를 확인 및 설정합니다.
	Subnet Mask	0.0.0.0	서브넷 마스크를 확인 및 설정합니다.
	Def. Gateway	0.0.0.0	기본 게이트웨이를 확인 및 설정합니다.
	DNS Server(P)	0.0.0.0	기본 DNS 서버를 확인 및 설정합니다.
	DNS Server(S)	0.0.0.0	보조 DNS 서버를 확인 및 설정합니다.
System Config	Clock Setting		본 기기의 시계를 설정합니다 (☞ 27페이지).
	Power Saving	Eco	에코 대기를 설정합니다 (☞ 12페이지).
	Auto Power Off	Timer 8H	기기가 자동으로 대기 모드로 설정됩니다 (☞ 12페이지).
	Use Accessory	NO	DC OUT 잭을 통해 Yamaha 액세서리에 전원을 공급할지 여부를 선택합니다.
	Firm Version		기기의 펌웨어 버전을 표시합니다.
	Firm Update	Network	기기의 펌웨어를 업데이트합니다 (☞ 30페이지).
	Advanced Setup (☞ 31페이지)	MAC Add.Filter	OFF
	Factory Reset		기기의 설정을 출고 시 기본값으로 재설정합니다.

*1 라디오 재생의 경우에만

문제 해결

본 기기가 올바르게 작동하지 않을 경우에는 아래의 표를 참조하십시오. 해당 문제가 아래의 표에 없거나 아래의 설명이 도움이 되지 않을 경우 본 기기를 고고 전원 케이블을 분리한 다음 가까운 Yamaha 지정 판매점이나 서비스 센터에 연락하십시오.

먼저 각 케이블의 커넥터가 각 장치의 잭에 단단히 꽂혀 있는지 확인하십시오.

일반사항

문제	원인	해결 방법
전원을 켜는 즉시 기기가 대기 모드로 들어갑니다. 기기가 올바르게 작동하지 않습니다.	전원 케이블이 제대로 연결되지 않았습니다.	전원 케이블을 단단히 연결하십시오.
전원이 꺼지지 않습니다.	외부의 전기 충격(번개 및 강한 정전기 등)이나 전원 공급 전압의 강하로 인해 내부 마이크로컴퓨터의 작동이 멈췄습니다.	전면 패널의  을 10초 이상 길게 눌러 본 기기를 초기화하고 재부팅하십시오. (문제가 지속되면 전원 케이블을 콘센트에서 분리하고 30초 이상 지난 다음 다시 연결하십시오.)
음향이 출력되지 않습니다.	적절한 음원이 선택되지 않았습니다. 스피커가 단단히 연결되지 않았습니다. 볼륨이 최소 또는 음소거 상태입니다.	전면 패널의 INPUT 또는 리모컨의 음원 버튼을 사용하여 해당 음원을 선택하십시오(☞ 5, 8페이지). 단단히 연결하십시오(☞ 9페이지). 볼륨을 올리십시오.
전원이 갑자기 꺼집니다.	취침 예약 타이머가 설정되었을 수 있습니다(☞ 29페이지). Auto Power Off가 설정되었습니다(☞ 12페이지).	기기를 켜고 음원을 다시 재생하십시오.
시계 설정이 지워졌습니다.	전원 케이블이 분리되었거나 정전되었습니다.	전원 케이블을 연결하고 시계를 다시 설정하십시오(☞ 27페이지).
한쪽 스피커에서만 사운드가 들립니다.	음원 장치 또는 스피커가 제대로 연결되지 않았습니다.	음원 장치 또는 스피커 케이블을 정확히 연결하십시오(☞ 9, 19페이지). 문제가 지속되면 케이블이 손상된 것일 수 있습니다.
디지털 또는 고주파수 장비에서 노이즈 간섭이 있습니다.	본 기기가 디지털 또는 고주파수 장비와 너무 가까이 있습니다.	본 기기와 해당 장비를 멀리 떨어뜨려 놓으십시오.
리모컨이 작동하지 않거나 올바르게 작동하지 않습니다.	리모컨이 작동 범위를 벗어났을 수 있습니다. 본 기기의 리모컨 센서가 직사 광선이나 인버터형 형광등과 같은 강한 조명에 노출되었을 수 있습니다. 배터리가 방전되었을 수도 있습니다. 기기의 센서와 리모컨 사이에 장애물이 있습니다.	작동 범위 내에서 리모컨을 작동하십시오(☞ 12페이지). 조명 또는 기기의 방향이나 기기의 위치를 바꾸십시오. 새 배터리로 교체하십시오(☞ 4페이지). 장애물을 제거하십시오.

네트워크

문제	원인	해결 방법
네트워크 기능이 작동하지 않습니다.	네트워크 매개변수(IP 주소)를 올바르게 가져오지 않았습니다.	라우터에서 DHCP 서버 기능을 활성화하고 기기의 옵션 메뉴에서 [Network Config]의 [DHCP Enabled]를 [YES]로 설정하십시오. 네트워크 매개변수를 수동으로 구성하려면 사용하려는 IP 주소가 다른 네트워크 장치에서 사용되고 있지 않은 IP 주소임을 확인하십시오(☞ 32페이지).
재생이 중지됩니다(곡을 다시 이어서 재생할 수 없습니다).	서버에 지원되지 않는 파일이 있습니다.	재생 중인 폴더에서 기기가 지원하지 않는 파일(이미지 파일 또는 숨겨진 파일 포함)을 제거하십시오.
	미디어 공유 설정이 올바르지 않습니다.	공유 설정을 구성하고 본 기기를 음악 콘텐츠가 공유되는 기기기로 선택하십시오(☞ 17페이지).
본 기기에서 PC가 검색되지 않습니다.	PC에 설치된 일부 보안 소프트웨어에서 본 기기의 PC 액세스를 차단하고 있습니다.	PC에 설치된 보안 소프트웨어의 설정을 확인하십시오.
	본 기기와 PC가 동일한 네트워크에 있지 않습니다.	네트워크 연결과 라우터의 설정을 확인하여 동일한 네트워크에 기기와 PC를 연결하십시오.
	본 기기에서 MAC 주소 필터가 활성화되어 있습니다.	기기의 옵션 메뉴의 [Advanced Setup]에서 [MAC Add.Filter]를 [OFF]로 설정하십시오(☞ 32페이지).
	멀티 SSID를 지원하는 라우터의 보조 SSID에 PC가 연결되어 있습니다.	PC가 보조 SSID에 연결된 경우 기본 SSID 또는 LAN에 연결된 장치에 대한 액세스가 제한됩니다(인터넷 액세스만 허용). PC를 기본 SSID에 연결하십시오.
	네트워크 장치 간에 여러 라우터가 연결되어 있습니다(이중 라우터).	임시로 인터넷 연결을 끊고 로컬 네트워크를 확인하고 동일한 라우터를 사용하려는 네트워크 장치를 연결하십시오.
PC의 파일을 볼 수 없거나 재생할 수 없습니다.	파일이 본 기기 또는 미디어 서버에서 지원되지 않습니다.	본 기기와 미디어 서버에서 지원되는 파일 형식을 사용하십시오(☞ 40페이지).
기기에서 일부 파일을 재생할 수 없습니다.	iTunes Store에서 구입한 DRM(Digital Rights Management)의 파일을 재생하려고 했습니다.	iTunes Store에서 구입한 DRM(Digital Rights Management)의 파일은 재생할 수 없습니다.
인터넷 라디오를 재생할 수 없습니다.	선택한 인터넷 라디오 방송국을 현재 사용할 수 없습니다.	라디오 방송국에 네트워크 문제가 있거나 서비스가 중단되었을 수 있습니다. 나중에 다시 시도해 보거나 다른 방송국을 선택하십시오.
	선택한 인터넷 라디오 방송국에서 현재 아무런 방송도 하지 않고 있습니다.	일부 인터넷 라디오 방송국의 경우 하루 중 특정 시간에는 방송을 하지 않는 경우도 있습니다. 나중에 다시 시도해 보거나 다른 방송국을 선택하십시오.
	네트워크 장치(라우터 등)의 방화벽 설정에서 네트워크 액세스를 제한합니다.	네트워크 장치의 방화벽 설정을 확인하십시오. 각 라디오 방송국에서 지정한 포트를 통해 통과할 경우에만 인터넷 라디오를 재생할 수 있습니다. 포트 번호는 라디오 방송국에 따라 다릅니다.

문제	원인	해결 방법
모바일 장치 전용 응용 프로그램이 기기를 감지하지 못합니다.	본 기기에서 MAC 주소 필터가 활성화되어 있습니다.	기기의 옵션 메뉴의 [Advanced Setup]에서 [MAC Add.Filter]를 [OFF]로 설정하거나 모바일 장치의 MAC 주소를 기기에 액세스할 수 있도록 지정하십시오(☞ 32페이지).
	본 기기와 모바일 장치가 동일한 네트워크에 존재하지 않습니다.	네트워크 연결과 라우터의 설정을 확인한 다음 동일한 네트워크에 본 기기와 모바일 장치를 연결하십시오.
	모바일 장치가 멀티 SSID를 지원하는 라우터의 보조 SSID에 연결되어 있습니다.	모바일 장치가 보조 SSID에 연결된 경우 기본 SSID 또는 LAN에 연결된 장치에 대한 액세스가 제한됩니다(인터넷 액세스만 허용). 모바일 장치를 기본 SSID에 연결하십시오.
	네트워크 장치 간에 여러 라우터가 연결되어 있습니다(이중 라우터).	임시로 인터넷 연결을 끊고 로컬 네트워크를 확인하고 동일한 라우터를 사용하려는 네트워크 장치를 연결하십시오.
네트워크를 통해 펌웨어를 업데이트할 수 없습니다.	네트워크 연결이 불안정합니다.	잠시 후에 다시 업데이트해 보십시오. 또는 USB 메모리를 통해 펌웨어를 업데이트하십시오(☞ 30페이지).

iPod

문제	원인	해결 방법
음향이 출력되지 않습니다.	iPod이 올바르게 연결되지 않았습니다.	iPod을 USB 잭에 다시 연결하십시오(☞ 15페이지).
	iPod 소프트웨어가 옛날 버전입니다.	Apple의 웹사이트에서 최신 iTunes 소프트웨어를 다운로드하여 iPod 소프트웨어 버전을 업데이트하십시오.
	iPod이 기기에 연결 중입니다.	잠시 기다리십시오.
iPod, 기기 또는 리모컨으로 iPod을 조작할 수 없습니다.	본 기기에서 해당 iPod이 지원되지 않습니다.	지원되는 iPod을 사용하십시오(☞ 39페이지).
	iPod이 올바르게 연결되지 않았습니다.	iPod을 USB 잭에 다시 연결하십시오(☞ 15페이지).
	iPod 소프트웨어가 옛날 버전입니다.	Apple의 웹사이트에서 최신 iTunes 소프트웨어를 다운로드하여 iPod 소프트웨어 버전을 업데이트하십시오. 최신 소프트웨어로도 문제가 해결되지 않으면 iPod을 리셋하십시오.
전면 패널 디스플레이에 재생 정보가 표시되지 않습니다.	iPod의 디스플레이 모드가 표준 모드로 설정되어 있으면 기기 또는 리모컨으로 iPod을 컨트롤할 수 없습니다. 확장 모드인 경우 iPod의 자체 컨트롤 기능이 작동하지 않습니다.	디스플레이 모드를 확인하십시오. (☞ 16페이지)
	iPod이 재생 정보 표시 기능을 지원하지 않습니다.	이 기능은 본 기기에서 지원하는 iPod에서만 사용할 수 있습니다(☞ 39페이지).
	디스플레이 모드가 표준 모드로 설정되었습니다.	디스플레이 모드를 확장 모드로 변경하십시오(☞ 16페이지).

문제 해결

문제	원인	해결 방법
iPod이 충전되지 않습니다.	iPod이 올바르게 연결되지 않았습니다.	iPod을 USB 잭에 다시 연결하십시오(☞ 15페이지).
	본 기기에서 해당 iPod이 지원되지 않습니다.	지원되는 iPod을 사용하십시오(☞ 39페이지).
	기기가 예코 대기 모드 상태입니다.	옵션 설정에서 [Power Saving]을 [Normal]로 설정하십시오(☞ 12페이지).

디스크

문제	원인	해결 방법
디스크를 넣은 후에 재생이 시작되지 않습니다. 일부 버튼이 작동하지 않습니다.	기기에 넣은 디스크가 호환되지 않을 수도 있습니다.	기기에서 지원되는 디스크를 사용하십시오(☞ 39페이지).
기기의 ▷/□ 또는 리모컨의 ▶ 을 누른 후에 즉시 재생이 시작되지 않습니다(즉시 중지됨).	디스크가 더러울 수 있습니다.	디스크를 깨끗하게 닦으십시오(☞ 39페이지).
	기기에 넣은 디스크가 지원되지 않을 수도 있습니다.	기기에서 지원되는 디스크를 사용하십시오(☞ 39페이지).
	기기를 추운 장소에서 따뜻한 장소로 이동하면 디스크 판독 렌즈에 응결 현상이 발생할 수 있습니다.	기기가 실내 온도로 조정될 때까지 한두 시간 기다렸다가 다시 시도하십시오.

USB 장치

문제	원인	해결 방법
본 기기에서 USB 장치가 검색되지 않습니다.	USB 장치가 USB 잭에 단단히 연결되지 않았습니다.	기기를 끄고 USB 장치를 다시 연결한 후 기기를 다시 켜십시오(☞ 15페이지).
	USB 장치의 파일 시스템이 FAT16 또는 FAT32가 아닙니다.	FAT16 또는 FAT32 형식의 USB 장치를 사용하십시오.
USB 장치에 있는 폴더와 파일을 볼 수 없습니다.	USB 장치의 데이터는 암호화를 통해 보호됩니다.	암호화 기능 없이 USB 장치를 사용합니다.

FM 수신

문제	원인	해결 방법
FM 스테레오 수신 시 잡음이 들립니다.	안테나가 올바르게 연결되지 않았습니다. 선택한 라디오 방송국이 해당 지역으로부터 멀리 있거나 안테나 입력이 약합니다.	안테나가 올바르게 연결되었는지 확인하고 안테나의 위치를 변경하십시오 (☞ 10페이지). 시판되는 옥외 안테나를 사용하십시오. 자세한 내용은 전문 판매점에 문의하십시오.
자동 튜닝이 작동하지 않습니다.	선택한 라디오 방송국이 해당 지역으로부터 멀리 있거나 안테나 입력이 약합니다.	시판되는 옥외 안테나를 사용하십시오. 자세한 내용은 전문 판매점에 문의하십시오. 수동 튜닝 방법을 사용하십시오 (☞ 23페이지).
선국 방송국을 선택할 수 없습니다.	선국(메모리)이 지워졌을 수도 있습니다.	방송국을 다시 선국하십시오 (☞ 23, 24페이지).
FM 안테나 또는 옥외 안테나가 올바르게 설치되었지만 수신 상태가 왜곡되거나 선명하지 않습니다.	다중 경로 반사 또는 기타 라디오 간섭이 발생했을 수 있습니다.	안테나의 높이, 방향 또는 배치를 변경하십시오.

전면 패널 디스플레이의 메시지

메시지	원인	해결 방법
Unknown	iPod에서 본 기기까지의 신호 경로에 문제가 있습니다.	iPod을 다시 연결하십시오.
	연결된 iPod/USB 장치가 본 기기에서 지원되지 않습니다.	지원되는 iPod/USB 장치를 사용하십시오(☞ 39페이지).
Timer not work	iPod 소프트웨어가 옛날 버전입니다.	Apple의 웹사이트에서 최신 iTunes 소프트웨어를 다운로드하여 iPod 소프트웨어 버전을 업데이트하십시오.
Overcurrent	기기가 예코 대기 모드 상태입니다.	옵션 설정에서 [Power Saving]을 [Normal]로 설정하십시오(☞ 12페이지).
Unplugged	연결된 iPod/USB 장치가 본 기기에서 지원되지 않습니다.	iPod/USB 장치를 분리하고 본 기기를 껐다가 다시 켜십시오. 이 방법으로 USB 장치의 문제가 해결되지 않으면 본 기기에서 재생할 수 없습니다.
	iPod/USB 장치가 제대로 연결되지 않았습니다.	iPod/USB 장치를 분리하고 다시 연결하십시오(☞ 15페이지).
No Disc	iPod/USB 장치가 단단히 연결되지 않았습니다.	iPod/USB 장치를 분리하고 다시 연결하십시오(☞ 15페이지).
	본 기기에 넣은 디스크가 본 기기에서 지원되지 않을 수도 있습니다.	기기에서 지원되는 디스크를 사용하십시오(☞ 39페이지).
No Songs	디스크가 더럽거나 이물질이 묻었을 수 있습니다.	디스크를 꺼낸 다음 깨끗하게 닦으십시오.
	디스크를 거꾸로 넣었습니다.	라벨이 있는 면이 위로 향하도록 디스크를 넣으십시오.
Initializing	디스크에 재생 가능한 파일이 없습니다.	재생 가능한 파일이 있는 디스크를 넣으십시오(☞ 39페이지).
	본 기기가 시동 중입니다.	메시지가 사라질 때까지 기다려 주십시오. 메시지가 3분 이상 표시되면 본 기기를 껐다가 다시 켜십시오.
Loading...	본 기기가 지정된 파일/콘텐츠를 로드 중입니다.	로드가 완료될 때까지 기다리십시오.
No Content	선택한 폴더에 재생 가능한 파일이 없습니다.	재생 가능한 파일이 있는 폴더를 선택하십시오(☞ 40페이지).
Not Connected	본 기기가 인터넷에 연결되지 않았습니다.	인터넷 연결을 확인하십시오.
Unsupported	본 기기가 지원하지 않는 파일을 재생하려고 시도 중입니다.	본 기기에서 지원하는 파일을 재생하십시오(☞ 40페이지).
No Operation	옵션 메뉴 설정 시 디스크 트레이를 열려고 했습니다.	옵션 설정이 완료된 후에 디스크 트레이를 여십시오.
Access Denied	PC에 대한 액세스가 거부되었습니다.	공유 설정을 구성하고 음악 콘텐츠가 공유되는 장치로 본 기기를 선택하십시오(☞ 17페이지).
	본 기기에서 USB 장치에 액세스할 수 없습니다.	본 기기를 끈 후 USB 장치를 다시 연결하십시오. 문제가 지속될 경우 다른 USB 장치를 연결해 보십시오.
Access Error	본 기기에서 iPod에 액세스할 수 없습니다.	iPod을 껐다가 다시 켜십시오.
	연결된 iPod이 본 기기에서 지원되지 않습니다.	본 기기에서 지원되는 iPod을 사용하십시오(☞ 39페이지).
Version Error	네트워크에서 본 기기까지의 신호 경로에 문제가 있습니다.	라우터와 모뎀이 켜져 있는지 확인하십시오.
	펌웨어 업데이트에 실패했습니다.	본 기기와 라우터 또는 허브 사이의 연결을 확인하십시오(☞ 11페이지). 펌웨어를 다시 업데이트하십시오.

지원되는 장치/미디어 및 파일 형식

지원되는 장치/미디어

PC

Windows Media Player 11 또는 Windows Media Player 12가 설치된 PC.

NAS

DLNA 버전 1.5와 호환되는 NAS.

USB 장치

- 본 기기는 FAT16 또는 FAT32 형식을 사용하는 USB 대용량 저장 장치(예: 플래시 메모리 또는 휴대용 오디오 플레이어)를 지원합니다.
- USB 대용량 저장 장치(USB 충전기 또는 USB 허브 등), PC, 카드 리더, 외장형 HDD 등을 제외한 장치를 연결하지 마십시오.
- 암호화된 USB 장치는 사용할 수 없습니다.

iPod

iPod	iPod touch(1, 2, 3, 4, 5 세대), iPod nano(2, 3, 4, 5, 6, 7 세대)
iPhone	iPhone 5, iPhone 4S, iPhone 4, iPhone 3GS, iPhone 3G, iPhone
iPad	iPad(4 세대), iPad mini, iPad(3 세대), iPad 2, iPad

(2013년 8월 현재)

참고

iPod은 저작권이 없는 자료 또는 법적으로 복제 및 재생이 승인된 자료의 개인적인 복제 및 재생을 수행하는 조건으로 사용이 허가되었습니다. 저작권 위반은 법적으로 금지됩니다.

디스크

- 본 기기는 디스크 또는 디스크 재킷에 다음 로고가 인쇄된 오디오 CD, CD-R/RW(ISO 9660 형식)에서 사용하도록 제작되었습니다.

오디오 CD



CD-R/RW*



* 다음 중 하나가 포함된 디스크.
FOR CONSUMER
FOR CONSUMER USE
FOR MUSIC USE ONLY

- 본 기기에서 8 cm 디스크를 재생할 수 있습니다. 디스크 트레이의 내부 홈에 디스크를 넣으십시오.

디스크에 대한 주의 사항

- 본 기기에 위에 기술된 유형 이외의 디스크를 넣지 마십시오. 그러면 본 기기가 손상될 수도 있습니다.
- CD-R/RW는 파이널라이즈되지 않은 경우 재생이 되지 않습니다.
- 디스크 특성 또는 기록 조건에 따라 일부 디스크를 재생하지 못할 수도 있습니다.
- 하트 모양의 디스크 등 비표준 모양의 디스크를 사용하지 마십시오.
- 표면이 심하게 긁히거나 금이 간 디스크 또는 뒤틀리거나 달라붙은 디스크는 사용하지 마십시오.

디스크 취급

- 디스크 표면을 만지지 마십시오. 디스크 가장자리나 가운데 구멍을 잡으십시오.
- 디스크 라벨에 쓸 때는 끝이 뾰족한 펜을 사용하십시오.
- 테이프, 실, 풀 등을 디스크에 올려 놓지 마십시오.
- 긁힘 방지를 위해 보호 커버를 사용하지 마십시오.
- 디스크 트레이에 이물질이 묻지 마십시오.
- 본 기기에 한 번에 디스크를 2개 이상 넣지 마십시오. 그러면 본 기기와 디스크가 모두 손상될 수 있습니다.
- 디스크가 더러워지면 깨끗하고 마른 천으로 가운데부터 가장자리 방향으로 닦으십시오. 레코드 클리너 또는 페인트 시너를 사용하지 마십시오.
- 고장날 우려가 있으므로 렌즈 클리너를 사용하지 마십시오.
- 직사광선이 비치거나 고온다습한 장소 또는 더러운 장소에 디스크를 두지 마십시오.
- 디스크를 사용하지 않을 때는 본 기기에서 꺼낸 다음, 해당 케이스에 넣어 보관하십시오.

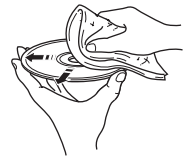
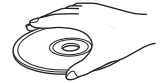

파일 형식

본 기기에서는 다음과 같은 파일 형식을 지원합니다.

DLNA/USB

- 본 기기는 WAV(PCM 형식만), MP3, WMA, MPEG-4 AAC 및 FLAC 파일(1 또는 2채널 오디오만)의 재생을 지원합니다.
- 본 기기는 WAV 및 FLAC 파일의 경우 최대 192 kHz, 기타 파일의 경우 최대 48 kHz의 샘플링 속도와 호환됩니다.
- FLAC 파일을 재생하려면 FLAC 파일을 지원하는 NAS를 사용하거나 DLNA를 통한 FLAC 파일 공유를 지원하는 서버 소프트웨어를 PC에 설치해야 합니다.
- Digital Rights Management(DRM) 콘텐츠는 재생할 수 없습니다.

디스크

- 본 기기는 최대 48 kHz의 샘플링 속도로 MP3 및 WMA 파일의 재생을 지원합니다.
- 본 기기는 MP3 파일의 경우 8 ~ 320 kbps, WMA 파일의 경우 16 ~ 320 kbps의 불변 및 가변 비트율과 호환됩니다.
- 본 기기는 최대 512개 파일, 255개 폴더를 재생할 수 있습니다(한 폴더에 최대 511개 파일).
- DRM(Digital Rights Management) 파일은 재생되지 않습니다.



AirPlay는 iOS 4.3.3 이상이 설치된 iPhone, iPad 및 iPod touch, OS X Mountain Lion이 설치된 Mac, iTunes 10.2.2 이상이 설치된 Mac 및 PC에서 작동합니다.

"Made for iPod", "Made for iPhone" 및 "Made for iPad"는 전자 부속품이 특히 iPod, iPhone 또는 iPad에 각각 연결하도록 설계되었으며 Apple 성능 표준에 적합한 것으로 개발자가 인증했음을 의미합니다.

Apple은 이 장치의 작동이나 안전 및 규제 표준 준수를 책임지지 않습니다.

이 부속품을 iPod, iPhone 또는 iPad와 함께 사용하면 무선 성능에 영향을 미칠 수 있습니다.

AirPlay, iPad, iPhone, iPod, iPod nano, iPod touch 및 iTunes는 미국 및 기타 국가에서 등록된 Apple Inc.의 상표입니다.



Fraunhofer Institut Integrierte Schaltungen

MPEG Layer-3 오디오 코딩 기술은 Fraunhofer IIS 및 Thomson에서 사용 허가를 얻었습니다.



본 기기는 네트워크 연결을 지원합니다.



DLNA™ 및 DLNA CERTIFIED™는 Digital Living Network Alliance의 상표 또는 등록 상표입니다. 모든 권리는 보호됩니다. 무단 사용은 엄격히 금지됩니다.

Windows™

Windows는 미국 및 기타 국가에서 Microsoft Corporation의 등록 상표입니다.

Internet Explorer, Windows Media Audio 및 Windows Media Player는 미국 및/또는 기타 국가에서 Microsoft Corporation의 등록 상표 또는 상표입니다.

Android™

Android 및 Google Play는 Google, Inc.의 상표입니다.

제품 사양

재생 부문

CD	미디어		CD, CD-R/RW
	오디오 형식		오디오 CD, MP3, WMA
	레이저	유형	반도체 레이저 GaAs/GaAlAs
		파장	790 nm
출력		10 mW	
iPod (디지털 연결)	지원되는 iPod		39페이지를 참조하십시오.
	지원되는 iPhone		
	지원되는 iPad		
USB	지원되는 파일 형식		MP3, WMA, MPEG4 AAC, WAV*, FLAC* * 최대 192 kHz/24비트
AUX IN	입력 커넥터	AUX1	스테레오 L/R: RCA
		AUX2	3.5 mm 스테레오 미니 잭
디지털 입력	입력 커넥터	DIGITAL IN 1	광학
		DIGITAL IN 2	동축
네트워크	인터페이스		100Base-TX/10Base-T
	인터넷 라디오		vTuner 서비스 지원
	PC 클라이언트 기능		DLNA Ver. 1.5(DMP/DMR 기능) 지원
	지원되는 파일 형식		MP3, WMA, MPEG4 AAC, WAV*, FLAC* * 최대 192 kHz/24비트
	AirPlay		AirPlay 지원

튜너 부문

튜닝 범위(FM)	87.50 ~ 108.00 MHz
-----------	--------------------

앰프 부문

최대 출력	32 W + 32 W(6 Ω 1 kHz, 10% THD)
총 고조파 왜곡 AUX1 1 kHz/12.5 W	0.05% 미만
EQ 제어	EQ High(고음)/EQ Mid(중음)/EQ Low(저음): ±10 dB
헤드폰	스테레오 L/R: 3.5mm 스테레오 미니 잭 적응 임피던스: 16 Ω - 32 Ω

일반사항

전원	아시아 모델	AC 220-240 V, 50/60 Hz
	대만 모델	AC110-120 V, 60 Hz
	중국 모델	AC 220 V, 50 Hz
	한국 모델	AC 220 V, 60 Hz
소비 전력		44 W
대기 모드일 때 소비 전력		6 W 미만
에코 대기 모드일 때 소비 전력		0.5 W 미만
규격(W × H × D)		215 × 110 × 288 mm
무게		2.7 kg

(2013년 8월 현재)
제품 사양은 통지 없이 변경될 수 있습니다.

- **Information about software**
- **Información sobre el software**
- **软件信息**
- **소프트웨어 관련 정보**

This product uses the following free software. For information (copyright, etc) about each software, read the original sentences stated below.

About ASN.1 object dumping code

ASN.1 object dumping code, copyright Peter Gutmann <pgut001@cs.auckland.ac.nz>, based on ASN.1 dump program by David Kemp <dpkemp@missi.ncsc.mil>, with contributions from various people including Matthew Hamrick <hamrick@rsa.com>, Bruno Couillard <bcouillard@chrysalis-its.com>, Hallvard Furuseth <h.b.furuseth@usit.uio.no>, Geoff Thorpe <geoff@raas.co.nz>, David Boyce <d.boyce@isode.com>, John Hughes <john.hughes@entegrity.com>, Life is hard, and then you die <ronald@trustpoint.com>, Hans-Olof Hermansson <hans-olof.hermansson@postnet.se>, Tor Rustad <Tor.Rustad@bbs.no>, Kjetil Barvik <kjetil.barvik@bbs.no>, James Sweeny <jsweeny@us.ibm.com>, and several other people whose names I've misplaced.

This code grew slowly over time without much design or planning, with features being tacked on as required.

It's not representative of my normal coding style.

About FLAC codec Library

Copyright ©
2000,2001,2002,2003,2004,2005,2006,2007,2008,2009 Josh Coalson

Redistribution and use in source and binary forms, with or without modification, are permitted provided that the following conditions are met:

Redistributions of source code must retain the above copyright notice, this list of conditions and the following disclaimer.

Redistributions in binary form must reproduce the above copyright notice, this list of conditions and the following disclaimer in the documentation and/or other materials provided with the distribution.

Neither the name of the Xiph.org Foundation nor the names of its contributors may be used to endorse or promote products derived from this software without specific prior written permission.

THIS SOFTWARE IS PROVIDED BY THE COPYRIGHT HOLDERS AND CONTRIBUTORS "AS IS" AND ANY EXPRESS OR IMPLIED WARRANTIES, INCLUDING, BUT NOT LIMITED TO, THE IMPLIED WARRANTIES OF MERCHANTABILITY AND FITNESS FOR A PARTICULAR PURPOSE ARE DISCLAIMED. IN NO EVENT SHALL THE FOUNDATION OR CONTRIBUTORS BE LIABLE FOR ANY DIRECT, INDIRECT, INCIDENTAL, SPECIAL, EXEMPLARY, OR CONSEQUENTIAL DAMAGES (INCLUDING, BUT NOT LIMITED TO, PROCUREMENT OF SUBSTITUTE GOODS OR SERVICES; LOSS OF USE, DATA, OR PROFITS; OR BUSINESS INTERRUPTION) HOWEVER CAUSED AND ON ANY THEORY OF LIABILITY, WHETHER IN CONTRACT, STRICT LIABILITY, OR TORT (INCLUDING NEGLIGENCE OR OTHERWISE) ARISING IN ANY WAY OUT OF THE USE OF THIS SOFTWARE, EVEN IF ADVISED OF THE POSSIBILITY OF SUCH DAMAGE.

About libexpat

Copyright © 1998, 1999, 2000 Thai Open Source Software Center Ltd and Clark Cooper

Copyright © 2001, 2002, 2003, 2004, 2005, 2006 Expat maintainers.

Permission is hereby granted, free of charge, to any person obtaining a copy of this software and associated documentation files (the "Software"), to deal in the Software without restriction, including without limitation the rights to use, copy, modify, merge, publish, distribute, sublicense, and/or sell copies of the Software, and to permit persons to whom

the Software is furnished to do so, subject to the following conditions:

The above copyright notice and this permission notice shall be included in all copies or substantial portions of the Software.

THE SOFTWARE IS PROVIDED "AS IS", WITHOUT WARRANTY OF ANY KIND, EXPRESS OR IMPLIED, INCLUDING BUT NOT LIMITED TO THE WARRANTIES OF MERCHANTABILITY, FITNESS FOR A PARTICULAR PURPOSE AND NONINFRINGEMENT. IN NO EVENT SHALL THE AUTHORS OR COPYRIGHT HOLDERS BE LIABLE FOR ANY CLAIM, DAMAGES OR OTHER LIABILITY, WHETHER IN AN ACTION OF CONTRACT, TORT OR OTHERWISE, ARISING FROM, OUT OF OR IN CONNECTION WITH THE SOFTWARE OR THE USE OR OTHER DEALINGS IN THE SOFTWARE.

About The Independent JPEG Group's JPEG software

The Independent JPEG Group's JPEG software

Copyright © 1991-2010, Thomas G. Lane, Guido Vollbeding.

All Rights Reserved except as specified below.

The authors make NO WARRANTY or representation, either express or implied, with respect to this software, its quality, accuracy, merchantability, or fitness for a particular purpose. This software is provided "AS IS", and you, its user, assume the entire risk as to its quality and accuracy.

Permission is hereby granted to use, copy, modify, and distribute this software (or portions thereof) for any purpose, without fee, subject to these conditions:

- (1) If any part of the source code for this software is distributed, then this README file must be included, with this copyright and no-warranty notice unaltered; and any additions, deletions, or changes to the original files must be clearly indicated in accompanying documentation.

- (2) If only executable code is distributed, then the accompanying documentation must state that “this software is based in part on the work of the Independent JPEG Group”.
- (3) Permission for use of this software is granted only if the user accepts full responsibility for any undesirable consequences; the authors accept NO LIABILITY for damages of any kind.

These conditions apply to any software derived from or based on the IJG code, not just to the unmodified library. If you use our work, you ought to acknowledge us.

Permission is NOT granted for the use of any IJG author’s name or company name in advertising or publicity relating to this software or products derived from it. This software may be referred to only as “the Independent JPEG Group’s software”.

We specifically permit and encourage the use of this software as the basis of commercial products, provided that all warranty or liability claims are assumed by the product vendor.

About JsonCpp

Copyright © 2007-2010 Baptiste Lepilleur

Permission is hereby granted, free of charge, to any person obtaining a copy of this software and associated documentation files (the “Software”), to deal in the Software without restriction, including without limitation the rights to use, copy, modify, merge, publish, distribute, sublicense, and/or sell copies of the Software, and to permit persons to whom the Software is furnished to do so, subject to the following conditions:

The above copyright notice and this permission notice shall be included in all copies or substantial portions of the Software.

THE SOFTWARE IS PROVIDED “AS IS”, WITHOUT WARRANTY OF ANY KIND, EXPRESS OR IMPLIED, INCLUDING BUT NOT LIMITED TO THE WARRANTIES OF MERCHANTABILITY, FITNESS

FOR A PARTICULAR PURPOSE AND NONINFRINGEMENT. IN NO EVENT SHALL THE AUTHORS OR COPYRIGHT HOLDERS BE LIABLE FOR ANY CLAIM, DAMAGES OR OTHER LIABILITY, WHETHER IN AN ACTION OF CONTRACT, TORT OR OTHERWISE, ARISING FROM, OUT OF OR IN CONNECTION WITH THE SOFTWARE OR THE USE OR OTHER DEALINGS IN THE SOFTWARE.

About Network

Copyright © 1988 Stephen Deering.

Copyright © 1992, 1993

The Regents of the University of California. All rights reserved.

Copyright © 1985, 1986, 1993

The Regents of the University of California. All rights reserved.

Redistribution and use in source and binary forms, with or without modification, are permitted provided that the following conditions are met:

- (1) Redistributions of source code must retain the above copyright notice, this list of conditions and the following disclaimer.
- (2) Redistributions in binary form must reproduce the above copyright notice, this list of conditions and the following disclaimer in the documentation and/or other materials provided with the distribution.
- (3) All advertising materials mentioning features or use of this software must display the following acknowledgement:

This product includes software developed by the University of California, Berkeley and its contributors.

- (4) Neither the name of the University nor the names of its contributors may be used to endorse or promote products derived from this software without specific prior written permission.

THIS SOFTWARE IS PROVIDED BY THE REGENTS AND CONTRIBUTORS “AS IS” AND ANY EXPRESS OR IMPLIED WARRANTIES, INCLUDING, BUT NOT LIMITED TO, THE IMPLIED WARRANTIES OF MERCHANTABILITY AND FITNESS FOR A PARTICULAR PURPOSE ARE DISCLAIMED. IN NO EVENT SHALL THE REGENTS OR CONTRIBUTORS BE LIABLE FOR ANY DIRECT, INDIRECT, INCIDENTAL, SPECIAL, EXEMPLARY, OR CONSEQUENTIAL DAMAGES (INCLUDING, BUT NOT LIMITED TO, PROCUREMENT OF SUBSTITUTE GOODS OR SERVICES; LOSS OF USE, DATA, OR PROFITS; OR BUSINESS INTERRUPTION) HOWEVER CAUSED AND ON ANY THEORY OF LIABILITY, WHETHER IN CONTRACT, STRICT LIABILITY, OR TORT (INCLUDING NEGLIGENCE OR OTHERWISE) ARISING IN ANY WAY OUT OF THE USE OF THIS SOFTWARE, EVEN IF ADVISED OF THE POSSIBILITY OF SUCH DAMAGE.

Copyright © 1982, 1986 Regents of the University of California.

All rights reserved.

Copyright © 1982, 1986, 1988 Regents of the University of California.

All rights reserved.

Redistribution and use in source and binary forms are permitted provided that the above copyright notice and this paragraph are duplicated in all such forms and that any documentation, advertising materials, and other materials related to such distribution and use acknowledge that the software was developed by the University of California, Berkeley. The name of the University may not be used to endorse or promote products derived from this software without specific prior written permission.

THIS SOFTWARE IS PROVIDED “AS IS” AND WITHOUT ANY EXPRESS OR IMPLIED WARRANTIES, INCLUDING, WITHOUT LIMITATION, THE IMPLIED WARRANTIES OF MERCHANTABILITY AND FITNESS FOR A PARTICULAR PURPOSE.

About PNG Reference Library

libpng versions 1.2.6, August 15, 2004, through 1.4.5, December 9, 2010, are Copyright © 2004, 2006-2010 Glenn Randers-Pehrson, and are distributed according to the same disclaimer and license as libpng-1.2.5 with the following individual added to the list of Contributing Authors

Cosmin Truta

libpng versions 1.0.7, July 1, 2000, through 1.2.5 - October 3, 2002, are Copyright © 2000-2002 Glenn Randers-Pehrson, and are distributed according to the same disclaimer and license as libpng-1.0.6 with the following individuals added to the list of Contributing Authors

Simon-Pierre Cadieux
Eric S. Raymond
Gilles Vollant

and with the following additions to the disclaimer:

There is no warranty against interference with your enjoyment of the library or against infringement. There is no warranty that our efforts or the library will fulfill any of your particular purposes or needs. This library is provided with all faults, and the entire risk of satisfactory quality, performance, accuracy, and effort is with the user.

libpng versions 0.97, January 1998, through 1.0.6, March 20, 2000, are Copyright © 1998, 1999 Glenn Randers-Pehrson, and are distributed according to the same disclaimer and license as libpng-0.96, with the following individuals added to the list of Contributing Authors:

Tom Lane
Glenn Randers-Pehrson
Willem van Schaik

libpng versions 0.89, June 1996, through 0.96, May 1997, are Copyright © 1996, 1997 Andreas Dilger
Distributed according to the same disclaimer and license as libpng-0.88, with the following individuals added to the list of Contributing Authors:

John Bowler
Kevin Bracey
Sam Bushell

Magnus Holmgren
Greg Roelofs
Tom Tanner

libpng versions 0.5, May 1995, through 0.88, January 1996, are Copyright © 1995, 1996 Guy Eric Schalnat, Group 42, Inc.
For the purposes of this copyright and license, "Contributing Authors" is defined as the following set of individuals:

Andreas Dilger
Dave Martindale
Guy Eric Schalnat
Paul Schmidt
Tim Wegner

The PNG Reference Library is supplied "AS IS". The Contributing Authors and Group 42, Inc. disclaim all warranties, expressed or implied, including, without limitation, the warranties of merchantability and of fitness for any purpose. The Contributing Authors and Group 42, Inc. assume no liability for direct, indirect, incidental, special, exemplary, or consequential damages, which may result from the use of the PNG Reference Library, even if advised of the possibility of such damage.

Permission is hereby granted to use, copy, modify, and distribute this source code, or portions hereof, for any purpose, without fee, subject to the following restrictions:

- (1) The origin of this source code must not be misrepresented.
- (2) Altered versions must be plainly marked as such and must not be misrepresented as being the original source.
- (3) This Copyright notice may not be removed or altered from any source or altered source distribution.

The Contributing Authors and Group 42, Inc. specifically permit, without fee, and encourage the use of this source code as a component to supporting the PNG file format in commercial products. If you use this source code in a product, acknowledgment is not required but would be appreciated.

About RC4 Algorithm

Copyright Mocana Corp 2003-2005. All Rights Reserved.

Proprietary and Confidential Material.

About WPA Supplicant

Copyright © 2003-2008, Jouni Malinen <j@w1.fi> and contributors

All Rights Reserved.

Redistribution and use in source and binary forms, with or without modification, are permitted provided that the following conditions are met:

- (1) Redistributions of source code must retain the above copyright notice, this list of conditions and the following disclaimer.
- (2) Redistributions in binary form must reproduce the above copyright notice, this list of conditions and the following disclaimer in the documentation and/or other materials provided with the distribution.
- (3) Neither the name(s) of the above-listed copyright holder(s) nor the names of its contributors may be used to endorse or promote products derived from this software without specific prior written permission.

THIS SOFTWARE IS PROVIDED BY THE COPYRIGHT HOLDERS AND CONTRIBUTORS "AS IS" AND ANY EXPRESS OR IMPLIED WARRANTIES, INCLUDING, BUT NOT LIMITED TO, THE IMPLIED WARRANTIES OF MERCHANTABILITY AND FITNESS FOR A PARTICULAR PURPOSE ARE DISCLAIMED. IN NO EVENT SHALL THE COPYRIGHT OWNER OR CONTRIBUTORS BE LIABLE FOR ANY DIRECT, INDIRECT, INCIDENTAL, SPECIAL, EXEMPLARY, OR CONSEQUENTIAL DAMAGES (INCLUDING, BUT NOT LIMITED TO, PROCUREMENT OF SUBSTITUTE GOODS OR SERVICES; LOSS OF USE, DATA, OR PROFITS; OR BUSINESS INTERRUPTION) HOWEVER CAUSED AND ON ANY THEORY OF LIABILITY, WHETHER IN CONTRACT, STRICT LIABILITY, OR TORT (INCLUDING NEGLIGENCE OR OTHERWISE) ARISING IN ANY WAY OUT OF THE USE OF THIS SOFTWARE, EVEN IF ADVISED OF THE POSSIBILITY OF SUCH DAMAGE.

About zlib Library

Copyright notice:

© 1995-2010 Jean-loup Gailly and Mark Adler

This software is provided 'as-is', without any express or implied warranty. In no event will the authors be held liable for any damages arising from the use of this software.

Permission is granted to anyone to use this software for any purpose, including commercial applications, and to alter it and redistribute it freely, subject to the following restrictions:

- (1) The origin of this software must not be misrepresented; you must not claim that you wrote the original software. If you use this software in a product, an acknowledgment in the product documentation would be appreciated but is not required.
- (2) Altered source versions must be plainly marked as such, and must not be misrepresented as being the original software.
- (3) This notice may not be removed or altered from any source distribution.

Do not disassemble, decompile, or reverse engineer the software included in Yamaha AV products.

