

SILENT *Piano*TM

SH2

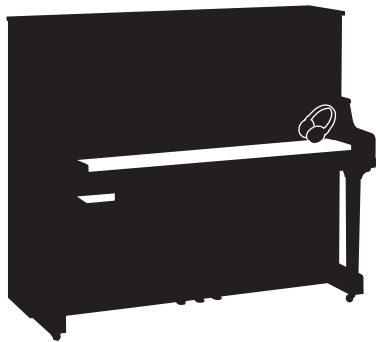

Owner's Manual
Mode d'emploi
Manual de instrucciones
Bedienungsanleitung
Manuale di istruzioni
사용설명서

Before using the instrument, be sure to read "PRECAUTIONS" on pages 7-8.

Avant d'utiliser cet instrument, lisez attentivement la section « PRÉCAUTIONS D'USAGE » aux pages 7-8.

Antes de utilizar el instrumento, lea la sección "PRECAUCIONES", en las páginas 7-8.

Achten Sie darauf, vor Einsatz dieses Instruments die „VORSICHTSMASSNAHMEN“ auf Seiten 7-8 durchzulesen.

Prima di utilizzare lo strumento, assicurarsi di leggere la sezione "PRECAUZIONI", alle pagine 7 - 8.

악기를 사용하기 전에 7 - 8페이지의 "안전 주의사항"을 꼭 읽으십시오.

SPECIAL MESSAGE SECTION

This product utilizes batteries or an external power supply (adapter). DO NOT connect this product to any power supply or adapter other than one described in the manual, on the name plate, or specifically recommended by Yamaha.

WARNING: Do not place this product in a position where anyone could walk on, trip over, or roll anything over power or connecting cords of any kind. The use of an extension cord is not recommended! If you must use an extension cord, the minimum wire size for a 25' cord (or less) is 18 AWG. NOTE: The smaller the AWG number, the larger the current handling capacity. For longer extension cords, consult a local electrician.

This product should be used only with the components supplied or; a cart, rack, or stand that is recommended by Yamaha. If a cart, etc., is used, please observe all safety markings and instructions that accompany the accessory product.

SPECIFICATIONS SUBJECT TO CHANGE:

The information contained in this manual is believed to be correct at the time of printing. However, Yamaha reserves the right to change or modify any of the specifications without notice or obligation to update existing units.

This product, either alone or in combination with an amplifier and headphones or speaker/s, may be capable of producing sound levels that could cause permanent hearing loss. DO NOT operate for long periods of time at a high volume level or at a level that is uncomfortable. If you experience any hearing loss or ringing in the ears, you should consult an audiologist.

IMPORTANT: The louder the sound, the shorter the time period before damage occurs.

Some Yamaha products may have benches and / or accessory mounting fixtures that are either supplied with the product or as optional accessories. Some of these items are designed to be dealer assembled or installed. Please make sure that benches are stable and any optional fixtures (where applicable) are well secured BEFORE using.

Benches supplied by Yamaha are designed for seating only. No other uses are recommended.

NOTICE:

Service charges incurred due to a lack of knowledge relating to how a function or effect works (when the unit is operating as designed) are not covered by the manufacturer's warranty, and are therefore the owners responsibility. Please study this manual carefully and consult your dealer before requesting service.

ENVIRONMENTAL ISSUES:

Yamaha strives to produce products that are both user safe and environmentally friendly. We sincerely believe that our products and the production methods used to produce them, meet these goals. In keeping with both the letter and the spirit of the law, we want you to be aware of the following:

Battery Notice:

This product MAY contain a small non-rechargeable battery which (if applicable) is soldered in place. The average life span of this type of battery is approximately five years. When replacement becomes necessary, contact a qualified service representative to perform the replacement.

This product may also use "household" type batteries. Some of these may be rechargeable. Make sure that the battery being charged is a rechargeable type and that the charger is intended for the battery being charged.

When installing batteries, never mix old batteries with new ones, and never mix different types of batteries. Batteries MUST be installed correctly. Mismatches or incorrect installation may result in overheating and battery case rupture.

Warning:

Do not attempt to disassemble, or incinerate any battery. Keep all batteries away from children. Dispose of used batteries promptly and as regulated by the laws in your area. Note: Check with any retailer of household type batteries in your area for battery disposal information.

Disposal Notice:

Should this product become damaged beyond repair, or for some reason its useful life is considered to be at an end, please observe all local, state, and federal regulations that relate to the disposal of products that contain lead, batteries, plastics, etc. If your dealer is unable to assist you, please contact Yamaha directly.

NAME PLATE LOCATION:

The name plate is located on the bottom of the product. The model number, power requirements, etc., are located on this plate. The serial number is located behind the control unit. You should record the model number, serial number, and the date of purchase in the spaces provided below and retain this manual as a permanent record of your purchase.

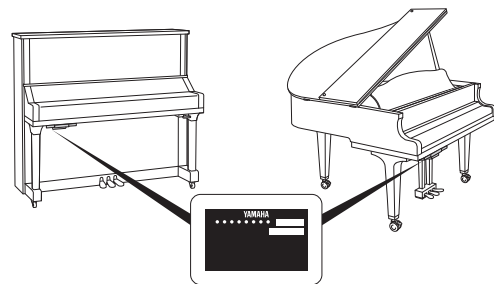

Model _____

Serial No. _____

Purchase Date _____

PLEASE KEEP THIS MANUAL

92-BP (bottom_silent)

For the instrument

COMPLIANCE INFORMATION STATEMENT(DECLARATION OF CONFORMITY PROCEDURE)

Responsible Party: Yamaha Corporation of America
Address: 6600 Orangethorpe Ave., Buena Park, Calif. 90620
Telephone: 714-522-9011
Type of Equipment: Silent Piano
Model Name: C1XSH2, C2XSH2, C3XSH2, C5XSH2, C6XSH2, C7XSH2,
GC1MSH2, GC2SH2, S3XSH2, S5XSH2, S6XSH2, S7XSH2,
U1SH2, U3SH2, YUS1SH2, YUS3SH2, YUS5SH2

This device complies with Part 15 of the FCC Rules.

Operation is subject to the following two conditions:

- 1) this device may not cause harmful interference, and
 - 2) this device must accept any interference received including interference that may cause undesired operation.
- See user manual instructions if interference to radio reception is suspected.

* This applies only to products distributed by YAMAHA CORPORATION OF AMERICA.

(FCC DoC)

For the AC adaptor and the instrument

FCC INFORMATION (U.S.A.)

1. IMPORTANT NOTICE: DO NOT MODIFY THIS UNIT!

This product, when installed as indicated in the instructions contained in this manual, meets FCC requirements. Modifications not expressly approved by Yamaha may void your authority, granted by the FCC, to use the product.

2. IMPORTANT: When connecting this product to accessories and/or another product use only high quality shielded cables. Cable/s supplied with this product **MUST** be used. Follow all installation instructions. Failure to follow instructions could void your FCC authorization to use this product in the USA.

3. NOTE: This product has been tested and found to comply with the requirements listed in FCC Regulations, Part 15 for Class "B" digital devices. Compliance with these requirements provides a reasonable level of assurance that your use of this product in a residential environment will not result in harmful interference with other electronic devices. This equipment generates/uses radio frequencies and, if not installed and used according to the instructions found in the users manual, may cause interference harmful to the operation of other electronic devices. Compliance with FCC regula-

tions does not guarantee that interference will not occur in all installations. If this product is found to be the source of interference, which can be determined by turning the unit "OFF" and "ON", please try to eliminate the problem by using one of the following measures:

Relocate either this product or the device that is being affected by the interference.

Utilize power outlets that are on different branch (circuit breaker or fuse) circuits or install AC line filter/s.

In the case of radio or TV interference, relocate/reorient the antenna. If the antenna lead-in is 300 ohm ribbon lead, change the lead-in to co-axial type cable.

If these corrective measures do not produce satisfactory results, please contact the local retailer authorized to distribute this type of product. If you can not locate the appropriate retailer, please contact Yamaha Corporation of America, Electronic Service Division, 6600 Orangethorpe Ave, Buena Park, CA90620

The above statements apply **ONLY** to those products distributed by Yamaha Corporation of America or its subsidiaries.

* This applies only to products distributed by YAMAHA CORPORATION OF AMERICA.

(class B)

The model number, power requirements, etc., are located on the name plate, which is at the bottom of the control unit. The serial number is located behind the control unit. You should note this serial number in the space provided below and retain this manual as a permanent record of your purchase to aid identification in the event of theft.

Model No.

Serial No.

(bottom_en_silent)

Modellnummer, Leistungsbedarf usw. sind auf dem Namensschild aufgeführt, das sich an der Unterseite der Steuereinheit befindet. Die Seriennummer befindet sich an der Rückseite der Steuereinheit. Für den Fall eines Diebstahls sollten Sie diese Seriennummer im unten vorgesehenen Feld eintragen und diese Anleitung als dauerhaften Kaufnachweis aufbewahren.

Modell Nr.

Seriennr.

(bottom_de_silent)

Le numéro de modèle de l'appareil, ses besoins en alimentation ainsi que d'autres informations le concernant figurent sur sa plaque signalétique, qui se trouve en bas de l'unité de commande. Le numéro de série est indiqué à l'arrière de l'unité de commande. Notez ce numéro de série dans l'espace fourni ci-dessous et conservez le présent manuel comme preuve permanente de votre achat afin de faciliter l'identification du produit en cas de vol.

N° de modèle

N° de série

(bottom_fr_silent)

Il numero del modello, i requisiti di alimentazione, ecc... si trovano sulla piastrina posizionata nella parte inferiore dell'unità di controllo. Il numero di serie si trova dietro l'unità di controllo. Si consiglia di riportare il numero di serie nell'apposito spazio di seguito e di conservare questo manuale come prova di acquisto permanente, al fine di consentire l'identificazione in caso di furto.

Numero del modello

Numero di serie

(bottom_it_silent)

El número de modelo, los requisitos de alimentación, etc. se encuentran en la placa de denominación, que está en la parte inferior de la unidad de control. El número de serie se encuentra detrás de la unidad de control. Debe anotar este número de serie en el espacio que se proporciona a continuación y conservar este manual como un registro permanente de su compra para facilitar la identificación en caso de robo.

N° de modelo

N° de serie

(bottom_es_silent)

본 제품의 모델 번호, 전원 규격 등은 기기 밑면에 있는 명판에서 확인할 수 있습니다. 일련 번호는 기기 후면에 있습니다. 도난 시 확인할 수 있도록 일련 번호를 아래 공간에 기입하고 본 사용설명서를 구매 기록으로 영구 보관해야 합니다.

모델 번호

일련 번호

(bottom_ko_silent)

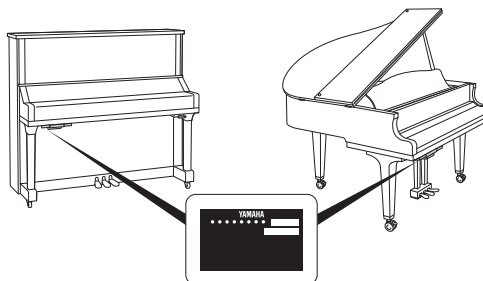

The name plate is located on the bottom of the unit.
 La plaque signalétique de ce produit se trouve dans le bas de l'unité.
 La placa del nombre se encuentra en la parte inferior de la unidad.
 Das Namensschild befindet sich an der Unterseite des Produkts.
 La targhetta del nome si trova sul fondo dell'unità.
 명판은 제품 밑면에 부착되어 있습니다.



SILENT *Piano*TM

SH2

Owner's Manual

Table of Contents

PRECAUTIONS.....	7	Chapter 5 Connecting to Other Devices	45
NOTICE	9	
About the Manuals	10	Connecting USB devices	45
Included Accessories	10	Connecting to external audio devices	47
Features.....	11	Connecting to external MIDI devices	49
Chapter 1 Getting Started	12	Connecting to a computer/smart device	50
Part names and functions	12	Chapter 6 Using Other Functions	54
Turning the power on/off	15	Backup data and initialization.....	54
Using headphones.....	16	Setting the Character Code for file names.....	55
Chapter 2 Playing with the Silent Piano™		Chapter 7 Appendix	56
Function.....	17	Message List.....	56
Using the Silent Piano™ function	17	Troubleshooting.....	58
Selecting Voices.....	18	Voice List.....	60
Chapter 3 Playing Back and Recording		Song List.....	62
Songs.....	20	Playback sequence of Song files in a USB flash drive	64
Playing back Songs.....	20	
Recording your performance	24	Specifications.....	65
Handling User Song files.....	27	Index	67
Chapter 4 Using Convenient Functions			
(UTILITY)	30		
Enhancing the sound with Reverb.....	30		
Using the metronome.....	32		
Customizing with the various Function parameters			
(Function settings).....	34		

Information for users on collection and disposal of old equipment:



This symbol on the products, packaging, and/or accompanying documents means that used electrical and electronic products should not be mixed with general household waste. For proper treatment, recovery and recycling of old products, please take them to applicable collection points, in accordance with your national legislation. By disposing of these products correctly, you will help to save valuable resources and prevent any potential negative effects on human health and the environment which could otherwise arise from inappropriate waste handling.

For more information about collection and recycling of old products, please contact your local municipality, your waste disposal service or the point of sale where you purchased the items.

For business users in the European Union:

If you wish to discard electrical and electronic equipment, please contact your dealer or supplier for further information.

Information on Disposal in other Countries outside the European Union:

This symbol is only valid in the European Union. If you wish to discard these items, please contact your local authorities or dealer and ask for the correct method of disposal.

(weee_eu_en_02)

For the AC adaptor

This device complies with Part 15 of the FCC Rules. Operation is subject to the following two conditions:

(1) this device may not cause harmful interference, and (2) this device must accept any interference received, including interference that may cause undesired operation.

CAN ICES-3 (B)/NMB-3(B)

(can_b_02)

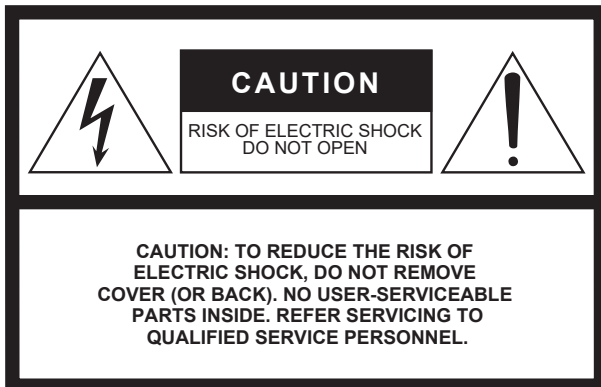

Explanation of Graphical Symbols

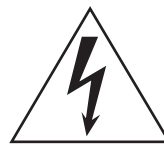

The lightning flash with arrowhead symbol within an equilateral triangle is intended to alert the user to the presence of uninsulated "dangerous voltage" within the product's enclosure that may be of sufficient magnitude to constitute a risk of electric shock to persons.



The exclamation point within an equilateral triangle is intended to alert the user to the presence of important operating and maintenance (servicing) instructions in the literature accompanying the product.

IMPORTANT SAFETY INSTRUCTIONS

- 1 Read these instructions.
- 2 Keep these instructions.
- 3 Heed all warnings.
- 4 Follow all instructions.
- 5 Do not use this apparatus near water.
- 6 Clean only with dry cloth.
- 7 Do not block any ventilation openings. Install in accordance with the manufacturer's instructions.
- 8 Do not install near any heat sources such as radiators, heat registers, stoves, or other apparatus (including amplifiers) that produce heat.
- 9 Do not defeat the safety purpose of the polarized or grounding-type plug. A polarized plug has two blades with one wider than the other. A grounding type plug has two blades and a third grounding prong. The wide blade or the third prong are provided for your safety. If the provided plug does not fit into your outlet, consult an electrician for replacement of the obsolete outlet.
- 10 Protect the power cord from being walked on or pinched particularly at plugs, convenience receptacles, and the point where they exit from the apparatus.
- 11 Only use attachments/accessories specified by the manufacturer.
- 12 Use only with the cart, stand, tripod, bracket, or table specified by the manufacturer, or sold with the apparatus. When a cart is used, use caution when moving the cart/apparatus combination to avoid injury from tip-over.
- 13 Unplug this apparatus during lightning storms or when unused for long periods of time.
- 14 Refer all servicing to qualified service personnel. Servicing is required when the apparatus has been damaged in any way, such as power-supply cord or plug is damaged, liquid has been spilled or objects have fallen into the apparatus, the apparatus has been exposed to rain or moisture, does not operate normally, or has been dropped.



WARNING

TO REDUCE THE RISK OF FIRE OR ELECTRIC SHOCK, DO NOT EXPOSE THIS APPARATUS TO RAIN OR MOISTURE.

(UL60065_03)

PRECAUTIONS

PLEASE READ CAREFULLY BEFORE PROCEEDING

Please keep this manual in a safe and handy place for future reference.

For the AC adaptor



WARNING

- This AC adaptor is designed for use with only Yamaha electronic devices. Do not use for any other purpose.
- Indoor use only. Do not use in any wet environments.



CAUTION

- When setting up, make sure that the AC outlet is easily accessible. If some trouble or malfunction occurs, immediately turn off the power switch of the instrument and disconnect the AC adaptor from the outlet. When the AC adaptor is connected to the AC outlet, keep in mind that electricity is flowing at the minimum level, even if the power switch is turned off. When you are not using the instrument for a long time, make sure to unplug the power cord from the wall AC outlet.

For the instrument



WARNING

Always follow the basic precautions listed below to avoid the possibility of serious injury or even death from electrical shock, short-circuiting, damages, fire or other hazards. These precautions include, but are not limited to, the following:

Power supply/AC adaptor

- Do not place the power cord near heat sources such as heaters or radiators. Also, do not excessively bend or otherwise damage the cord, or place heavy objects on it.
- Only use the voltage specified as correct for the instrument. The required voltage is printed on the name plate of the instrument.
- Use the specified adaptor (page 66) only. Using the wrong adaptor can result in damage to the instrument or overheating.
- Check the electric plug periodically and remove any dirt or dust which may have accumulated on it.
- Unplug the power cord from the AC outlet when cleaning the instrument.

Do not open

- This instrument contains no user-serviceable parts. Do not open the instrument or attempt to disassemble or modify the internal components in any way. If it should appear to be malfunctioning, discontinue use immediately and have it inspected by qualified Yamaha service personnel.

Location

- Radio waves may affect electro-medical devices.
 - Do not use this product near medical devices or inside areas in which the use of radio waves is restricted.
 - Do not use this product within 15cm (6 in.) of persons with a heart pacemaker implant.

Water warning

- Do not expose the instrument to rain, use it near water or in damp or wet conditions, or place on it any containers (such as vases, bottles or glasses) containing liquids which might spill into any openings. If any liquid such as water seeps into the instrument, turn off the power immediately and unplug the power cord from the AC outlet. Then have the instrument inspected by qualified Yamaha service personnel.
- Never insert or remove an electric plug with wet hands.

Fire warning

- Do not put burning items, such as candles, on the unit. A burning item may fall over and cause a fire.

If you notice any abnormality

- When one of the following problems occur, immediately turn off the power switch and disconnect the electric plug from the outlet. Then have the device inspected by Yamaha service personnel.
 - The power cord or plug becomes frayed or damaged.
 - It emits unusual smells or smoke.
 - Some object has been dropped into the instrument.
 - There is a sudden loss of sound during use of the instrument.

CAUTION

Always follow the basic precautions listed below to avoid the possibility of physical injury to you or others, or damage to the instrument or other property. These precautions include, but are not limited to, the following:

Power supply/AC adaptor

- Do not connect the instrument to an electrical outlet using a multiple-connector. Doing so can result in lower sound quality, or possibly cause overheating in the outlet.
- When removing the electric plug from the instrument or an outlet, always hold the plug itself and not the cord. Pulling by the cord can damage it.
- Remove the electric plug from the outlet when the instrument is not to be used for extended periods of time, or during electrical storms.

Location

- Do not place the instrument in an unstable position where it might accidentally fall over.
- Before moving the instrument, remove all connected cables, to prevent damage to the cables or injury to anyone who might trip over them.
- When moving the instrument, be careful to avoid catching your hands or feet on the instrument.
- Move the instrument slowly with extra care to keep the instrument from falling over, or bumping against the surroundings. We recommend that you consult a qualified carrier to transport or move the instrument.
- When setting up the product, make sure that the AC outlet you are using is easily accessible. If some trouble or malfunction occurs, immediately turn off the power switch and disconnect the plug from the outlet. Even when the power switch is turned off, electricity is still flowing to the product at the minimum level. When you are not using the product for a long time, make sure to unplug the power cord from the wall AC outlet.

Connections

- Before connecting the instrument to other electronic components, turn off the power for all components. Before turning the power on or off for all components, set all volume levels to minimum.
- Be sure to set the volumes of all components at their minimum levels and gradually raise the volume controls while playing the instrument to set the desired listening level.

Handling caution

- Do not insert a finger or hand in any gaps on the fallboard or instrument. Also take care that the fallboard does not pinch your finger.
- Never insert or drop paper, metallic, or other objects into the gaps or opening on the main unit, fallboard, or keyboard. This could cause physical injury to you or others, damage to the instrument or other property, or operational failure.
- Do not rest your weight on, or place heavy objects on the instrument, and do not use excessive force on the buttons, switches or connectors.
- Do not use the instrument/device or headphones for a long period of time at a high or uncomfortable volume level, since this can cause permanent hearing loss. If you experience any hearing loss or ringing in the ears, consult a physician.
- Close the fallboard when the instrument is not in use. Hold the fallboard with both hands when opening or closing it. Be careful to avoid catching fingers (yours or others) between the fallboard and the main unit.
- Do not go near the instrument during an earthquake. Strong shaking during an earthquake could cause the instrument to move or tip over, resulting in damage to the instrument or its parts, and possibly causing injury.

Yamaha cannot be held responsible for damage caused by improper use or modifications to the instrument, or data that is lost or destroyed.

Always turn the power off when the instrument is not in use.

Even when the [] (Standby/On) switch is in standby status (power lamp is off), electricity is still flowing to the instrument at the minimum level.

When you are not using the instrument for a long time, make sure you unplug the power cord from the wall AC outlet.

NOTICE

To avoid the possibility of malfunction/ damage to the product, damage to data, or damage to other property, follow the notices below.

■ Handling

- Do not connect this product to public Wi-Fi and/or Internet directly. Only connect this product to the Internet through a router with strong password-protections. Consult your router manufacturer for information on security best practices.
- Do not use the instrument in the vicinity of a TV, radio, stereo equipment, mobile phone, or other electric devices. Otherwise, the instrument, TV, or radio may generate noise. When you use the instrument along with a smart device, such as an iPhone, iPad, etc., we recommend that you set that device's "Airplane Mode" to on and then the Wi-Fi/Bluetooth setting to on in order to avoid noise caused by communication.
- Do not expose the instrument to excessive dust or vibrations, or extreme cold or heat (such as in direct sunlight, near a heater, or in a car during the day) to prevent the possibility of panel disfiguration, damage to the internal components or unstable operation.
- Do not place vinyl, plastic or rubber objects on the instrument, since this might discolor the panel or keyboard.
- Bumping the surface of the instrument with metal, porcelain, or other hard objects can cause the finish to crack or peel. Use caution.
- Do not drag the instrument when moving it. Doing so may damage the floor.

■ Maintenance

- When cleaning the instrument, use a soft and dry cloth. Do not use paint thinners, solvents, alcohol, cleaning fluids, or chemical-impregnated wiping cloths.
- Gently remove dust and dirt with a soft cloth. Do not wipe too hard since small particles of dirt can scratch the instrument's finish.
- During extreme changes in temperature or humidity, condensation may occur and water may collect on the surface of the instrument. If water is left, the wooden parts may absorb the water and be damaged. Make sure to wipe any water off immediately with a soft cloth.

■ Saving data

- The MIDI Song recorded to this instrument (page 20) are retained when the power is turned off. However, the saved data may be lost due to some failure, an operation mistake, etc. Save your important data onto an external device such as a computer (page 50).
- To protect against data loss through USB flash drive damage, we recommend that you save your important data onto spare USB flash drive or an external device such as a computer as backup data.

Information

■ About copyrights

- Copying of the commercially available musical data including but not limited to MIDI data and/or audio data is strictly prohibited except for your personal use.
- This product incorporates and bundles contents in which Yamaha owns copyrights or with respect to which Yamaha has license to use others' copyrights. Due to copyright laws and other relevant laws, you are NOT allowed to distribute media in which these contents are saved or recorded and remain virtually the same or very similar to those in the product.
 - * The contents described above include a computer program, Accompaniment Style data, MIDI data, WAVE data, voice recording data, a score, score data, etc.
 - * You are allowed to distribute medium in which your performance or music production using these contents is recorded, and the permission of Yamaha Corporation is not required in such cases.

■ About functions/data bundled with the instrument

- Some of the preset songs have been edited for length or arrangement, and may not be exactly the same as the original.

■ About this manual

- The illustrations as shown in this manual are for instructional purposes only, and may appear somewhat different from those on your instrument.
- Windows is a registered trademark of Microsoft® Corporation in the United States and other countries.
- iPhone, iPad and iPod touch are trademarks of Apple Inc., registered in the U.S. and other countries.
- The Bluetooth® word mark and logos are registered trademarks owned by Bluetooth SIG, Inc. and any use of such marks by Yamaha Corporation is under license.



- The company names and product names in this manual are the trademarks or registered trademarks of their respective companies.

■ About Bluetooth communications

- The 2.4 GHz band used by Bluetooth compatible devices is a radio band shared by many types of equipment. While Bluetooth compatible devices use a technology minimizing the influence of other components using the same radio band, such influence may reduce the speed or distance of communications and in some cases interrupt communications.
- The speed of signal transfer and the distance at which communication is possible differs according to the distance between the communicating devices, the presence of obstacles, radio wave conditions and the type of equipment.
- Yamaha does not guarantee all wireless connections between this unit and devices compatible with Bluetooth function.

Thank you for choosing the Yamaha Silent Piano™. This instrument is equipped with the same keyboard mechanisms as an acoustic piano. However, you can play with the sound muted, and use various functions not available on an acoustic piano, such as changing Voices or recording your performance. This manual mainly explains these functions as a Silent Piano. In order to make the most of the performance potential and features of the instrument, please read the manuals thoroughly, and keep them in a handy place for later reference.

About the Manuals

This instrument has the following documents and instructional materials.

■ Included Documents



Owner's Manual (this book)

This manual mainly describes how to use the particular functions for the Silent Piano™ which can be used when the power is turned on. For information on handling as an acoustic piano, refer to the separate manual for the piano.

■ Online Materials (downloadable from the website)



iPhone/iPad Connection Manual (only in English, French, German and Spanish)

Explains how to connect the instrument to smart devices, such as an iPhone, iPad, etc.



Computer-related Operations

Includes instructions on connecting this instrument to a computer, and operations related to transferring data.



MIDI Reference

Contains MIDI related information.

To obtain these manuals, access the Yamaha Downloads, enter the model name for searching the desired files.

Yamaha Downloads

<http://download.yamaha.com/>

Included Accessories

- Owner's Manual (this book) x 1
- AC adaptor* x 1
- Power cord* x 1
- Headphones x 1
- Headphone hanger x 1
- Attachment screws for headphone hanger x 2
- "50 Classical Music Masterpieces" music book x 1

*May not be included depending on your area. Check with your Yamaha dealer.

Features

- **Silencing System enables you play in any situation, at any time you want**

Yamaha's innovative silencing system brings you superior performance, yet with virtually complete silence. Enjoy your performance just as if you were playing an acoustic piano—but without the need to worry about bothering people around you.

- **Non-contact sensors for maximum expressiveness**

The non-contact optical sensors faithfully detect subtle movement of the keys without affecting the touch of the keys. They catch keystroke information precisely, enabling you to perform with rich nuance and extraordinarily subtle expression.

- **Elegant, integrated design**

The control unit has been given a graceful design that unobtrusively blends with the piano itself. Moreover, the simple controllers allow you to operate the instrument easily.

- **Realistic ambience of the Voices enhances your performance**

This instrument puts the sound of 20 luxurious, authentic Voices at your fingertips. These include Yamaha's flagship CFX piano—which delivers dynamic sound, from a brilliant high-range to powerful bass—and the Bösendorfer* Imperial, a world-class piano renowned for its subtle and warm sound. The instrument also features advanced technologies such as Binaural Sampling. Listening with headphones to a piano Voice enhanced through these methods gives the impression of being thoroughly immersed in the sound, as if it was actually emanating from the piano.

Altogether, it delivers real sound faithful to that of an actual acoustic piano, such as the quick attack and the graceful resonance of a sustained piano tone, as well as how the sound responds to your playing strength, and the resonance effect when the damper pedal is pressed.

* Bösendorfer is a subsidiary company of Yamaha.

- **Playback and recording functions for aid in learning and practice**

You can record your performance to this instrument and a USB flash drive, and improve your performance by listening back to the recording. This instrument also features a Bluetooth audio function, which allows you to play along on this instrument with audio from a Bluetooth-equipped device, and even record the audio as an audio Song.

Smart Device App “Smart Pianist”

The smart device app “Smart Pianist” (available as a free download) enables you to use the functions such as selecting Voices, controlling the metronome intuitively with the visualized interface, or display the score on your smart device.

For information about this app, access the following web page:

<https://www.yamaha.com/kbdapps/>

The connection wizard of the Smart Pianist helps you to connect this unit to your smart device properly. To start connection wizard, tap [☰] (Menu) located upper left on the Smart Pianist screen to open the menu, then tap “Instrument” followed by “Start Connection Wizard.”

Getting Started

Part names and functions

■ Piano

Upright Piano

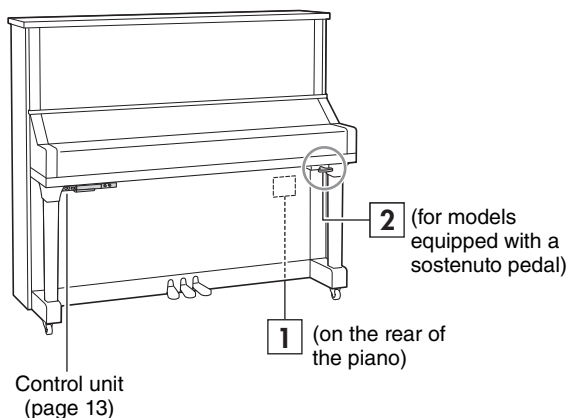

Grand Piano

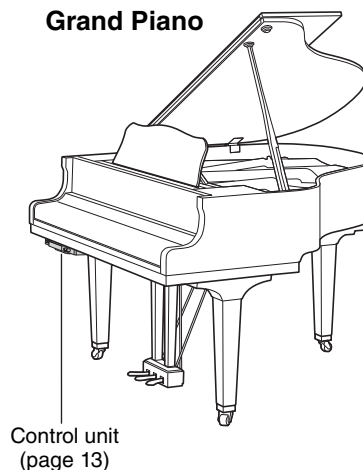

- 1 DC IN jack**
For connecting the supplied AC adaptor (page 15).

- 2 Silencing lever**
Activates the Silent Piano™ function.

■ Pedals

Upright Piano

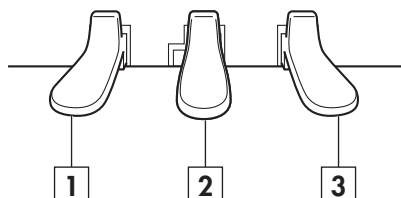

- 1 Soft pedal**
Reduces the volume and slightly changes the timbre of the notes. The notes played before this pedal is pressed are not affected.
- 2 Silencing pedal** (for models not equipped with a sostenuto pedal)
Activates the Silent Piano™ function by pressing and sliding to the left.

Sostenuto pedal (for models equipped with a sostenuto pedal)
Sustains the notes that are being played at that time even after you release the keys. Subsequently played notes are not affected.

Grand Piano

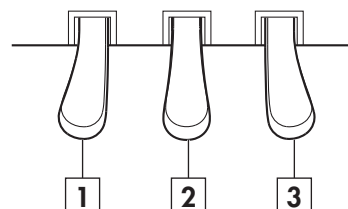

- 3 Damper pedal**
Sustains notes even after you release the keys. When the Silent Piano™ function is enabled and a piano Voice is selected, pressing this pedal reproduces the complicated interaction of both strings and soundboard resonance by the VRM technology (page 40), and makes the sound more like a real acoustic piano. The damper pedal features an expressive half-pedal function, and allows you to set the degree to which pressing the damper pedal applies the half-pedal effect (page 39) when using the Silent Piano™ function.

■ Control unit

Front panel

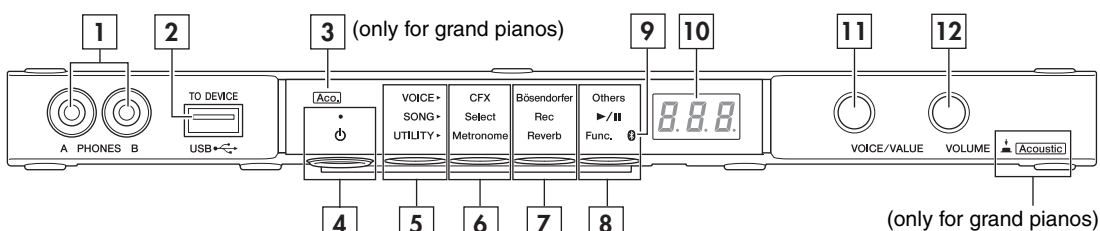

Bottom panel

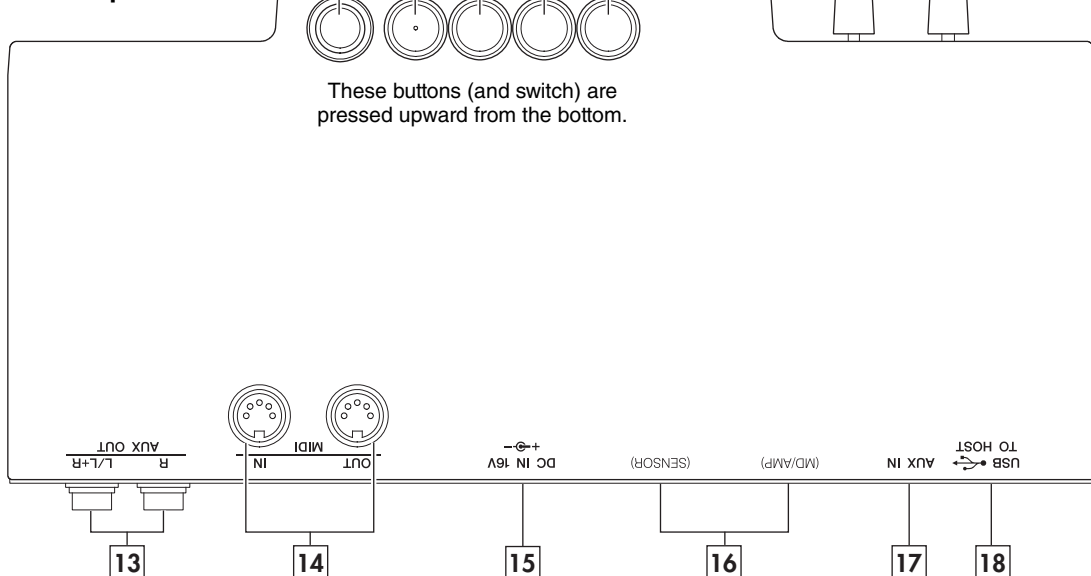

1 [PHONES] jacks

For connecting a pair of headphones with stereo mini plug (page 16). Up to two headphones can be connected.

2 USB [TO DEVICE] terminal

For connecting a USB flash drive or an optional USB wireless LAN adaptor (page 45).

3 [Aco.] lamp (only for grand pianos)

When the lamp is lit, the sound is produced by using the acoustic piano mechanics (page 17).

4 [⏻] (Standby/On) switch

For turning the power on or setting to standby (page 15).

5 Mode button

Each time you press this button, the mode changes in the following order, and the lamp of the selected mode lights up in orange.

• VOICE mode

For controlling the Voice (page 18).

• SONG mode

For recording your performance or playing back preset Songs, recorded Songs, etc. (page 20).

• UTILITY mode

For setting various convenient functions, such as the metronome (page 30).

6 Button 1, 7 Button 2, 8 Button 3

Depending on the selected mode, different functions are assigned and can be controlled by pressing each button.

9 [Bluetooth] lamp

Lights up when the Bluetooth function is on (page 52). It lights up in blue when the instrument is connected with a Bluetooth-equipped device, and it lights up in white when no Bluetooth-equipped device is connected and while in the UTILITY mode.

10 Display

Indicates various setting values, such as Voice number, Song number and other parameter values.

11 [VOICE/VALUE] control

Rotating this allows you to select desired Voices or adjust the setting values. Depending on particular functions, you may need to press this to control the function.

12 [VOLUME] control

For adjusting the volume of the entire sound output via the [PHONES] jack, AUX OUT jacks, USB [TO HOST] terminal or Bluetooth. (Only grand pianos) Pressing the control can activate or deactivate the Silent Piano™ function (page 17).

13 AUX OUT [R]/[L/L+R] jacks

For connecting an external audio device and output the sound of this unit to the device (page 47).

14 MIDI [IN]/[OUT] terminals

For connecting an external MIDI device (page 49).

15 [DC IN 16V] jack

(Upright piano) For connecting the power cord. This is connected to the DC IN jack on the rear of the piano when the instrument is shipped.

(Grand piano) For connecting the supplied AC adaptor (page 15).

16 [SENSOR] jack/ [MD/AMP] jack

(For qualified Yamaha personnel only.) These connect to the sensor and to the internal unit. The plugs are already connected when the instrument is shipped.

17 [AUX IN] jack

For connecting an audio device such as a portable music player and input the sound to this unit (page 48).

18 USB [TO HOST] jack

For connecting to a computer or a smart device (page 50).

Display

Indicates various values such as Song number and Parameter value.



Song number



Parameter value

This display also indicates various messages with the three characters. For details, refer to page 56.

Turning the power on/off

1 Connect the plugs of the AC adaptor in the order shown in the illustration.

Make sure to loop the power cord through the metal hook attached to the rear (for upright pianos) or the bottom (for grand pianos) of the piano.

Upright piano

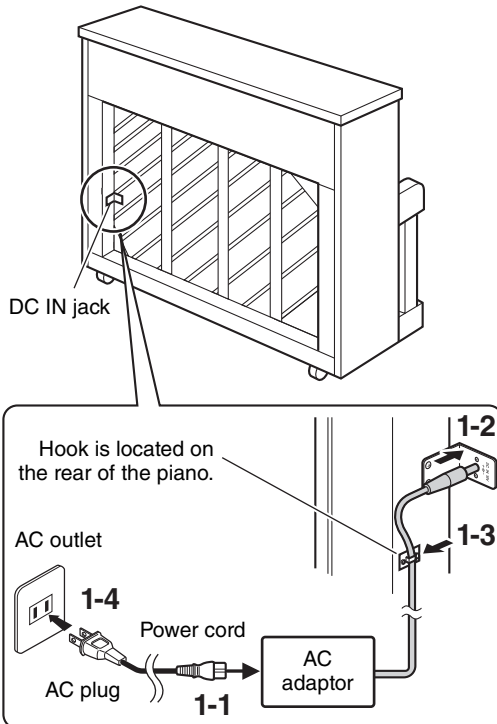

Grand piano

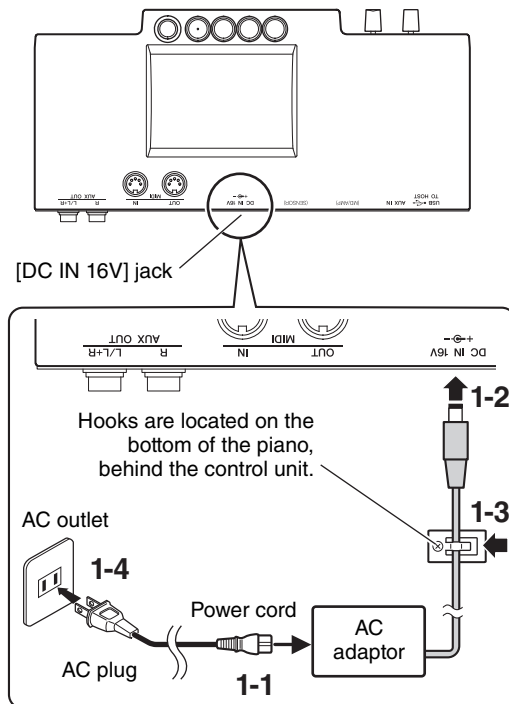

The shape of the plug and outlet differ depending on your locale.

⚠ WARNING

Use the specified adaptor (page 66) only. Use of other adaptors may result in irreparable damage to both the adaptor and the instrument.

⚠ CAUTION

When setting up the product, make sure that the AC outlet you are using is easily accessible. If some trouble or malfunction occurs, immediately turn the power off and disconnect the plug from the outlet.

NOTE

When disconnecting the AC adaptor, first turn the power off, and then follow the order shown above in reverse.

2 Press the [⏻] (Standby/On) switch to turn the power on.

The [⏻] (Standby/On) lamp lights up.
To turn the power off, press the switch again.

NOTE

The sound will not be properly output if a key was pressed when the power was turned on. Do not touch any keys when turning the power on.

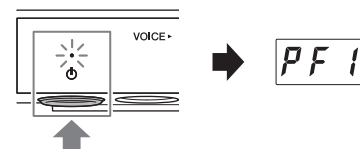

⚠ CAUTION

Even when the instrument is turned off, electricity is still flowing to the instrument at the minimum level. When you are not using the instrument for a long time or during electrical storms, make sure you unplug the AC power plug from the wall AC outlet.

Auto Power Off function

To prevent unnecessary power consumption, this unit features an Auto Power Off function that automatically turns the power off if the instrument is not operated for 30 minutes.

NOTICE

When the instrument is communicating with other devices or the Songs are played back, the power will not be turned off automatically. Make sure to turn off the power by pressing the [⏻] (Standby/On) switch when the instrument is not in use.

Disabling Auto Power Off

Turn the power on while holding down the lowest key (A-1). "PoF" appears on the display and the unit starts up with the Auto Power Off function disabled.

To turn the Auto Power Off function on or off while the power is on, refer to page 43.

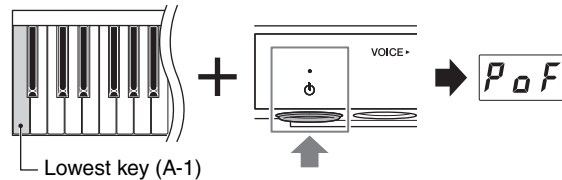

Using headphones

Connect a pair of headphones to the [PHONES] jack. Since this instrument is equipped with two [PHONES] jacks, you can connect two pairs of headphones. If you are using only one pair, insert the plug into either of these jacks.

Even when listening through headphones, you can enjoy exceptionally realistic, natural sound by Yamaha's advanced technologies, Binaural Sampling and Stereophonic Optimizer. For details, refer to page 19.

CAUTION

- Do not use the headphones for a long period of time at a high or uncomfortable volume level, since this can cause permanent hearing loss.
- Be careful not to catch your foot on the headphone cord.

NOTICE

Do not pull the cord of the headphones or apply excessive force on the plug. This can damage the headphones and result in sound degradation.

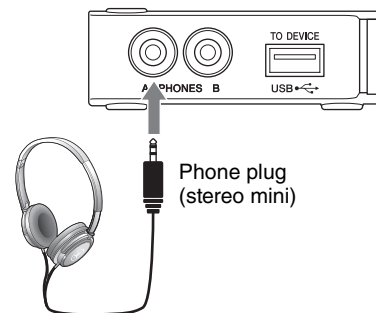

■ Attaching the headphone hanger

Attach the headphone hanger to the bottom of the control unit with the supplied two screws.

NOTICE

Do not hang anything other than the headphones on the hanger. Otherwise, the instrument or the hanger may be damaged.

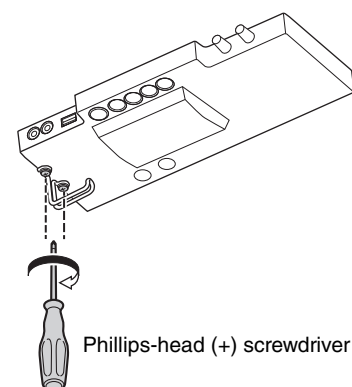

Playing with the Silent Piano™ Function

This instrument can be played both as a normal acoustic piano, and also as a Silent Piano™. Enabling the Silent Piano™ function lets you take advantage of a variety of powerful functions—such as playing preset Voices built into unit and recording your performances. Try out the Silent Piano™ function and explore the possibilities.

Using the Silent Piano™ function

1 Plug the headphones into the [PHONES] jack (page 16).

2 Rotate the [VOLUME] control to the far-left position to set the volume to minimum.

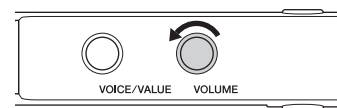

3 Press the [⏻] (Standby/On) switch to turn the power on.

4 Activate the Silent Piano™ function by one of the following operations.

These operations prevent the hammers from actually striking the strings.

(For upright pianos equipped with a sostenuto pedal)

- Pull the silencing lever towards you until you hear a click and feel the mechanism catch.

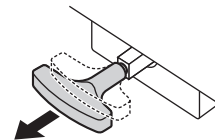

(For upright pianos not equipped with a sostenuto pedal)

- Press the center pedal and slide it to the left.

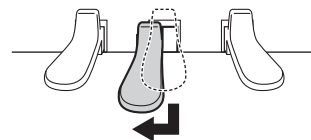

(For grand pianos)

- Make sure that the [Aco.] lamp is turned off.

If the lamp is lit, press the [VOLUME] control to turn it off.

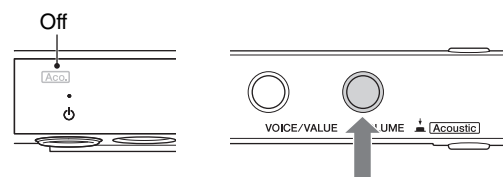

NOTE

For grand pianos, the Silent Piano™ function is activated (the [Aco.] lamp is off) automatically, when the power of the unit is turned on. If you want to play an acoustic piano, turn the [Aco.] lamp on by pressing the [VOLUME] control.

5 While playing the keyboard, adjust the volume level by rotating the [VOLUME] control.

Rotating to the right increases the volume, while rotating to the left decreases it.

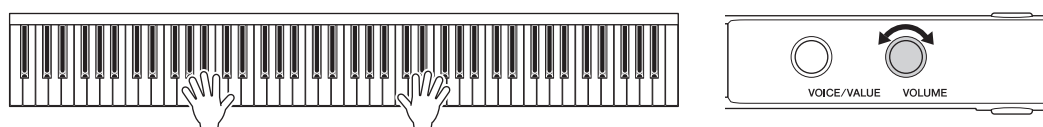

NOTE

The physical sound of the keyboard mechanism remains even when the Silent Piano™ function is active.

Selecting Voices

When the Silent Piano™ function is enabled, you can select and play the various built-in preset Voices from the keyboard. By default, the CFX Grand is always selected when the power is turned on. For the available Voices, refer to the “Voice List” on page 19.

1 Press the Mode button several times until the [VOICE] lamp lights up in orange.

The currently selected Voice number is shown on the display.

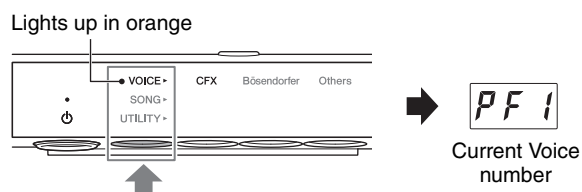

2 Use the [VOICE/VALUE] control or one of Buttons 1 – 3 to select the desired Voice.

The selected Voice can be confirmed by the lamp and the display.

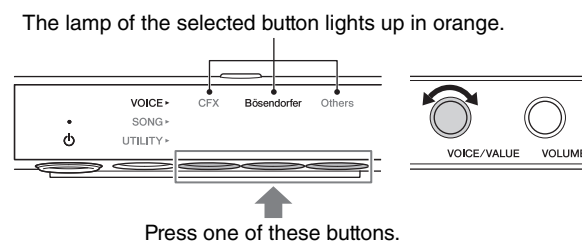

• [VOICE/VALUE] control

Rotating the control one by one switches the Voice to the next or previous one in the order of the Voice List. Pressing this control instantly selects the CFX Grand (PF1) Voice.

• Button 1 [CFX]

Pressing this button selects the CFX Grand (PF1) Voice.

• Button 2 [Bösendorfer]

Pressing this button selects the Bösendorfer Imperial (PF2) Voice.

• Button 3 [Others]

Pressing this button selects the first Voice in each category (PF3, EP1, HS1, Or1, Pd1, Ly1) in order. While the power is on, the Voice selected by Button 3 [Others] is retained. Pressing Button 3 [Others] can call up the last selected Voice instantly. When the power is turned off, the Voice for Button 3 resets to the Upright Piano (PF3) Voice.

NOTE

- To hear and experience the characteristics of the Voices, listen to the Demo Songs for each Voice (page 20).
- You can change various settings such as sound effect, Touch Sensitivity, tuning, etc. in the Function Settings (page 34).
- Changing the Voice while pressing the keyboard may cause a sudden large change in the volume.

Voice List

Button	Display	Voice Name	Button	Display	Voice Name		
1	<i>PF 1</i>	Binaural CFX Grand	3	<i>H 5 3</i>	Celesta		
		CFX Grand			Organ Principal		
2	<i>PF 2</i>	Bösendorfer Imperial			<i>Or 1</i>	Organ Tutti	
3	<i>PF 3</i>	Upright Piano			<i>Or 2</i>	Jazz Organ	
		Pop Grand			<i>Or 3</i>	Strings	
		Ballad Grand			<i>Pd 1</i>	Choir	
		<i>EP 1</i>			Stage E.Piano	<i>Pd 2</i>	Synth Pad
		<i>EP 2</i>			DX E.Piano	<i>Pd 3</i>	Piano + Strings
		<i>EP 3</i>			Vintage E.Piano	<i>LY 1</i>	Piano + Pad
		<i>H 5 1</i>			Harpsichord 8'	<i>LY 2</i>	Piano + DX E.Piano
		<i>H 5 2</i>			Harpsichord 8'+4'	<i>LY 3</i>	

NOTE

For details on each Voice, refer to page 60.

■ Reproducing a natural sound distance sensation (even when using headphones)—Binaural Sampling and Stereophonic Optimizer

This instrument features two advanced technologies that allow you to enjoy exceptionally realistic, natural sound, even though listening on headphones. These functions can be turned on or off as desired (page 40).

Binaural Sampling (CFX Grand Voice only)

Binaural Sampling is a method that uses two special microphones set at the ear position of a performer and records the sound from a piano as it would actually be heard. Listening to the sound with this effect through headphones gives the impression of being immersed in the sound, as if it was actually emanating from the piano. When the CFX Grand Voice is selected, binaural sampled sound is produced.

Stereophonic Optimizer (Piano Voices other than CFX Grand)

Stereophonic Optimizer is an effect which reproduces the natural sound distance, like with the sound of Binaural Sampling, even though you are listening to it on headphones. When one of the Piano Voices other than CFX Grand (page 60) is selected, the Stereophonic Optimizer is enabled.

Playing Back and Recording Songs

The preset songs, your recorded performances, and commercially available songs are referred to as “Songs” in this manual. This instrument can play or record MIDI Songs and Audio Songs.

Available Song format

Songs		Data formats	Extension
MIDI Songs	In a MIDI song, the information of your keyboard performance (such as keystroke and velocity) is recorded. This is not a recording of the actual sound. Based on the performance information, the tone generator outputs the sound. A MIDI Song uses a small amount of data capacity in comparison to an Audio song, and allows you to easily change aspects of the sound, such as Voices used, etc.	SMF format 0 Standard MIDI File format 0 for playback and recording. MIDI songs recorded with this unit are saved in this format. SMF format 1 Standard MIDI File format 1 for playback only.	.MID
Audio Songs	An Audio Song is a recording of the performed sound itself. This data is recorded in the same way as that used in recording cassette tapes, or with voice recorders, etc. This data can be played with a portable music player, etc., allowing you to easily let other people hear your performance.	WAV Audio file format commonly used by computers. This instrument can play 44.1kHz/16bit stereo WAV files. Audio Songs recorded on this instrument are saved in this format.	.WAV

Playing back Songs

Songs that can be played (Song Category)

Song Category		Song Number	Description	
<i>d.</i>	Voice Demo Song (MIDI)	d.01 – d.20	Demo Songs which effectively demonstrates each Voice (page 62) on this unit.	
<i>P.</i>	Preset Song (MIDI)	P.01 – P.50	50 classical piano preset Songs (page 62) stored to this unit. These Songs correspond to the score in the music book “50 Classical Music Masterpieces,” included with this unit.	
<i>R.</i>	USB flash drive*	User Song (Audio)	A.00 – A.99	Audio Songs which have been recorded with this unit and saved to a USB flash drive (page 24).
<i>C.</i>		External Song (Audio)**	C.00 – C.99, 100 – 399	External Audio Songs, commercially available or which have been recorded on a computer, etc. and saved to a USB flash drive.
<i>S.</i>		User Song (MIDI)	S.00 – S.99	MIDI Songs which have been recorded with this unit and saved to a USB flash drive (page 24).
<i>F.</i>		External Song (MIDI)**	F.00 – F.99, 100 – 399	External MIDI Songs, commercially available or which have been recorded on a computer, etc. and saved to a USB flash drive.
<i>U.</i>	Internal memory	User Song (MIDI)	U.01 – U.10	MIDI Songs which have been recorded to internal memory of this unit (page 24).
<i>L.</i>		External Song (MIDI)**	L.01 – L.99	External MIDI Songs (commercially available or which have been recorded on a computer, etc.) transferred from a computer to this unit.

* The Song categories for USB flash drive are shown only when the USB flash drive is connected.

** The External Song categories are shown only when the data exist.

For information about the playback sequence of Song files in the USB flash drive, refer to page 64.

NOTE

- Songs recorded by this instrument are called “User Songs” while Songs created in other ways or on other devices are called “External Songs.” When you record a Song to a USB flash drive, a “USER FILES” folder is created automatically and the resulting User Song will be saved in this folder. Songs in the “USER FILES” folder are handled as User Songs while Songs in a location other than the “USER FILES” folder are handled as External Songs.
- You can also play back the music software for Disklavier purchased from the “Yamaha MusicSoft” website. For further information, refer to the following website:
Yamaha MusicSoft: <http://www.yamahamusicsoft.com/>

- 1** (Only when you play the Song in a USB flash drive)
Connect the USB flash drive to the USB [TO DEVICE] terminal at the front of the control unit.

Before using the USB flash drive, be sure to read “Connecting USB devices” on page 45.

- 2** Press the Mode button several times until the [SONG] lamp lights up in orange.

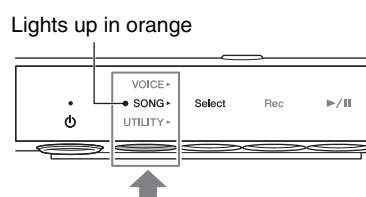

- 3** Press Button 1 [Select] several times to select the Song category (page 20).

NOTE

The category (L.) for External Songs in internal memory cannot be selected by this operation above.

First, select the category (U.) for the User Songs in the internal memory, then go on to step 4. It is shown between the Song “U.10” and “U.rd.”

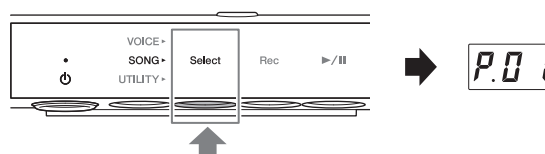

- 4** Rotate the [VOICE/VALUE] control to select the desired Song.

When you call up one of the following displays, all Songs in the category are played back continuously until you stop playback. When you call up others, the selected Song is played back and playback stops automatically when the end of the Song is reached.

- *rd (Random Playback)..... Continuously plays back all Songs in the selected category in random order.
- *AL (All-repeat Playback)..... Continuously plays back all Songs in the selected category in number order.

The asterisk (*) indicates one of the Song categories. For example, selecting “P.rd” can play all Preset Songs in random order.

NOTE

- Pressing the [VOICE/VALUE] control can select the first Song in the selected Song category.
- Continuous playback is not available for Demo Songs.
- When “U.rd” or “U.AL” is selected, External Songs in the internal memory are also played back as well as User Songs.

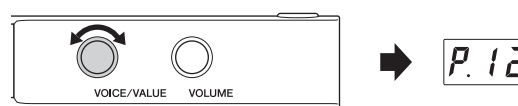

5 Press Button 3 [▶/||] (Play/Pause) to start playback.

The [▶/||] (Play/Pause) lamp lights up and the current position (measure number or elapsed time) will appear in the display.

The dot at the lower right of the display will flash at the MIDI Song tempo (or the metronome tempo when playing back an Audio Song).

For operations during playback, see the next section.

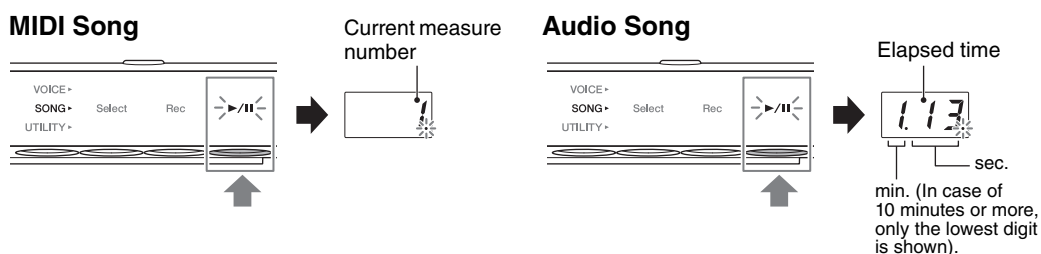

NOTE

The current position is not displayed when playing back Demo Songs.

■ Operations during playback

Playback continues even when you change the mode during playing the Song. Only when the instrument is in the SONG mode, the following operations are available.

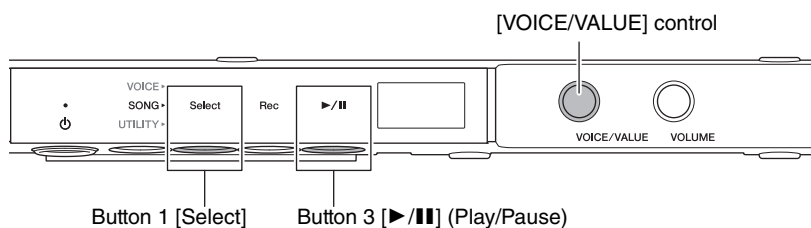

• Pause

During playback, press Button 3 [▶/||] (Play/Pause) to pause playback. The display will also pause and the [▶/||] (Play/Pause) lamp flashes will flash. Pressing the button again resumes Song playback from the current position.

• Stop

During playback, press Button 1 [Select] to stop playback. When the end of the current Song is reached, playback stops automatically.

When the Song is played back next time by pressing Button 3 [▶/||] (Play/Pause), it starts from the beginning.

• Rewind/Fast forward

During playback or pausing, rotate the [VOICE/VALUE] control. Rotate the control to the left to rewind, rotate it to the right to fast forward.

MIDI Songs are moved one measure back or forward, while Audio Songs are moved one second.

NOTE

Rewind and fast forward operations are not available for Demo Songs.

• Returning to the Song Top

During playback, press the [VOICE/VALUE] control to jump to the top of the Song.

NOTE

During playback of a Demo Song, this operation selects the Demo Song "d.01."

• Adjusting the Playback Tempo

You can change the tempo of MIDI Song or the speed of Audio Song during playback. It can be adjusted in the same operation as the metronome tempo. For details, refer to page 32.

MIDI Songs: The tempo can be adjusted from 5 to 500 beats per minutes. It can also be adjusted while the Song is paused. When the Song stops, it reset to the default setting.

Audio Songs: Compared to an original speed of 100%, it can be adjusted over the range of 75% – 125%. The setting value is maintained until another Song is selected.

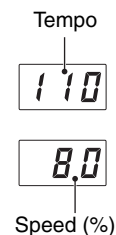

NOTE

- For MIDI Songs having tempo changes in the middle of the Song, changing the tempo alters entire tempo relatively. For example, in a Song that is set to a tempo of 100 at the start and changes midway during the Song to 120, changing the starting tempo to 110 (10% faster) will result in a midway tempo of 132 (10% faster).
- When the MIDI Song tempo is changed, the metronome tempo is also changed to the same tempo. The Audio Song speed does not affect the metronome tempo.
- While the Audio Song is paused and the metronome is played back, this operation changes only the metronome tempo and the Audio Song speed is not changed.

Recording your performance

You can record your performance on this instrument as a MIDI Song (SMF format 0) or an Audio Song (WAV format). Up to 10 MIDI Songs can be saved (at 500KB/Song max.) to internal memory and up to 100 to a USB flash drive. Up to 100 Audio Songs can be saved (at 80 minutes/Song max.) to a USB flash drive.

When the Song is recorded to a USB flash drive, a MIDI Song will be named "USERSONG**.MID" (**: 00 -99) and an Audio Song will be named "AUDIOSONG**.WAV", and saved to the "USER FILES" folder.

NOTE

You cannot start recording during Song playback. Make sure to stop playback beforehand.

- (Only when you record a Song to a USB flash drive)
Connect a USB flash drive to the USB [TO DEVICE] terminal at the front of the control unit.

Before using the USB flash drive, be sure to read "Connecting USB devices" on page 45.

- Make necessary settings such as selecting a Voice (page 18).**

- Press the Mode button several times until the [SONG] lamp lights up in orange.**

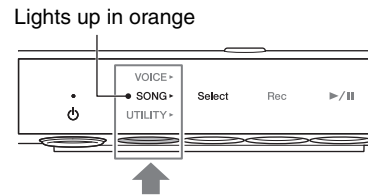

- Press Button 1 [Select] to select the recording format (Song category).**

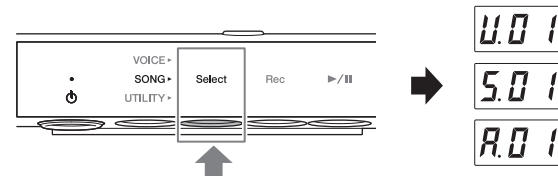

- For MIDI recording to internal memory..... U. (U.01 – U.10)
- For MIDI recording to a USB flash drive S. (S.00 – S.99)
- For Audio recording to a USB flash drive..... A. (A.00 – A.99)

5 Rotate the [VOICE/VALUE] control to select the Song number for recording.

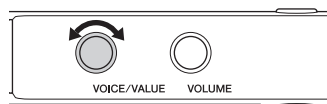

- **When the selected Song contains already-recorded data:**

You can confirm it by checking the display.

- **When Song contains data:**



Three dots light up.

- **When Song does not contain data:**



Only the left-most dot lights up.

NOTICE

When the selected Song contains data, keep in mind that recording new data will erase the existing data.

If you want to play along with the metronome sound, turn the metronome on here.

NOTE

The metronome sound will not be recorded.

6 Press Button 2 [Rec] to put recording in standby.

The [Rec] lamp lights in red, and the [▶/||] (Play/Pause) lamp flashes in orange.

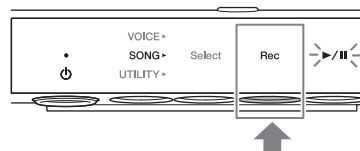

NOTE

- To cancel recording standby status, press Button 2 [Rec] again.
- When an “EnP” or “FUL” message appears on the display, the memory capacity of the internal memory or the USB flash drive is nearly full. We recommend that you first remove any unnecessary User Songs (page 28) to ensure sufficient memory capacity. If “Enp” appears, you can start recording, but your performance data may not be correctly saved or recording may stop automatically. If “FUL” appears, you cannot start recording.

7 Play the keyboard to start recording.

When you wish to record an empty section at the start of the Song, press Button 3 [▶/||] (Play/Pause) to start recording.

The [▶/||] lamp turns to be lit, and the current position (measure number or elapsed time) is shown on the display while recording.

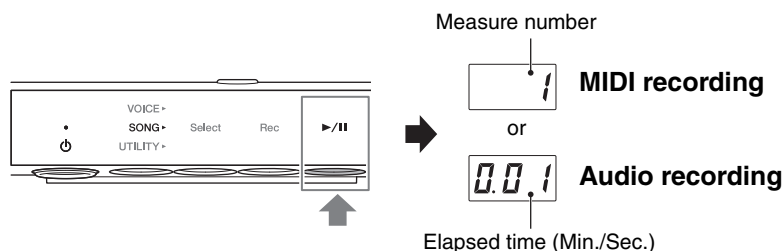

Min.: Indicates minutes. In case of 10 minutes or more, only the lowest digit is shown.
Sec.: Indicates seconds.

NOTICE

If “FUL” appears on the display while or after recording, it indicates the internal memory or USB flash drive capacity becomes full and all or the part of the data will not be saved. We recommend that you first delete any unnecessary User Songs (page 28) to ensure sufficient memory capacity.

NOTE

In case of Audio recording, the audio input from external device such as a computer or smart device (via the [AUX IN] jack, USB [TO HOST] terminal, wireless LAN, or Bluetooth) can also be recorded. For connection with these devices, refer to page 47.

8 When your performance is finished, press Button 2 [Rec] or Button 3 [▶/||] (Play/Pause) to stop recording

Dashes appear on the display in succession, indicating that the recorded data is being saved. After the data is saved, an “End” message appears, and the recorded Song number will appear. Pressing Button 3 [▶/||] (Play/Pause) plays back the recorded Song.

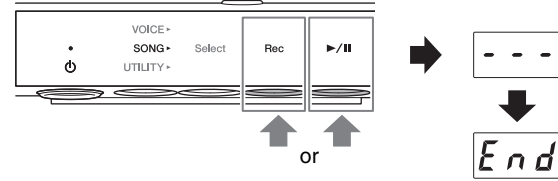

NOTICE

While dashes appear on the display in succession, never turn off the power. Doing so may corrupt the data or damage the internal memory or USB flash drive.

NOTE

- If you stop recording without playing the keyboard, the selected Song data is deleted for MIDI recording, while a blank (silent) Song is saved for Audio recording.
- The recorded User Song in the internal memory can be copied to a USB flash drive (page 27).

Handling User Song files

You can copy the User Song saved in the internal memory to a USB flash drive. Also, you can delete the User Songs in the internal memory or a USB flash drive.

NOTE

- Before using the USB flash drive, be sure to read “Connecting USB devices” on page 45.
- While a Song is being recorded, played back or paused, you cannot start these operations. Make sure to stop the Song beforehand.

■ Copying User Songs in the internal memory to a USB flash drive

You can copy the User Song in the internal memory to the connected USB flash drive. We recommend to copy your important Song to the USB flash drive. The copied Song is saved as SMF format 0 to the “USER FILES” folder in the USB flash drive, and the file is automatically named as “USERSONG**.MID” (**: numerals).

NOTE

Demo Songs and Preset Songs cannot be copied.

1 Connect a USB flash drive to the USB [TO DEVICE] terminal at the front of the control unit.

2 Press the Mode button several times until the [SONG] lamp lights up in orange.

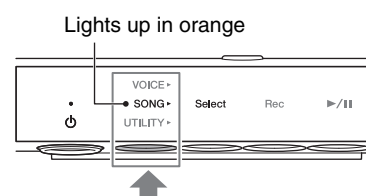

3 Press Button 1 [Select] to select the Song category “U” (User Song).

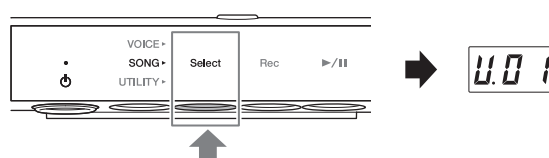

4 Rotate the [VOICE/VALUE] control to select the Song number (U.01 – U.10) to copy.

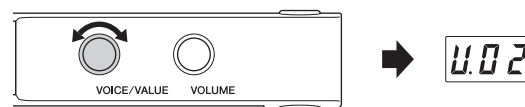

5 Press the Mode button several times until the [UTILITY] lamp lights up in orange.

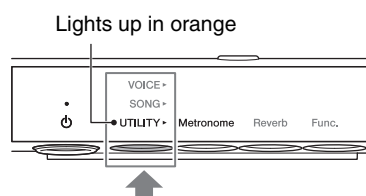

6 Press Button 3 [Func.] to enter the Function Settings.

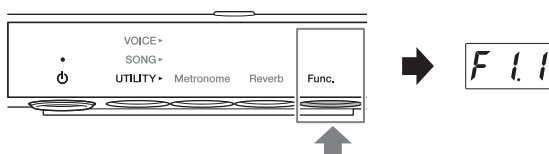

7 Rotate the [VOICE/VALUE] control to select “F7.1.”

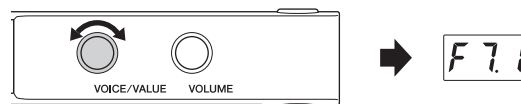

8 Press Button 3 [Func.] to call up “SAv” in the display.

The smallest MIDI Song number which has no data in the USB flash drive is automatically selected as the copy destination and the number is shown in the display.

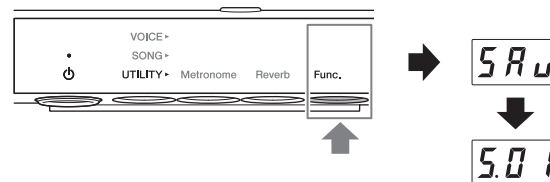

NOTE

- To cancel the copying operation, press any button other than Button 3 while the Song number is shown.
- If there is no empty MIDI Song number in the USB flash drive, “FUL” appears on the display and the copying operation cannot be completed. Delete any unnecessary User Songs (page 28), then execute the copy operation again.

9 Press Button 3 [Func.] again to start copying.

Dashes appear in succession on the display, indicating that the copy operation is in progress. When the operation is completed, “End” appears on the display.

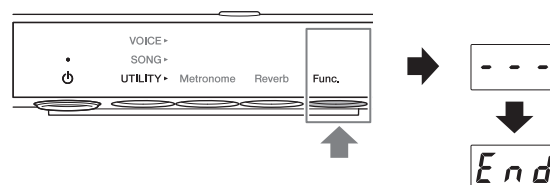

NOTICE

While dashes appear on the display in succession, never turn off the power. Doing so may corrupt the data or damage the internal memory or USB flash drive.

■ Deleting User Songs

You can delete the User Songs saved in the internal memory or the USB flash drive.

NOTE

The Songs other than the User Songs cannot be deleted.

1 Connect a USB flash drive to the USB [TO DEVICE] terminal at the front of the control unit.

2 Press the Mode button several times until the [SONG] lamp lights up in orange.

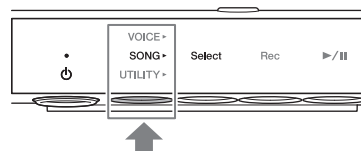

3 Press Button 1 [Select] to select the category of the Song to be deleted.

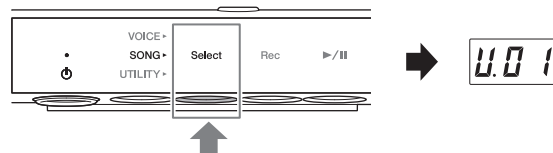

- U. (U.01 – U.10).....User Songs in internal memory (MIDI)
- S. (S.00 – S.99)User Songs in a USB flash drive (MIDI)
- A. (A.00 – A.99).....User Songs in a USB flash drive (Audio)

4 Rotate the [VOICE/VALUE] control to select the Song number to delete.

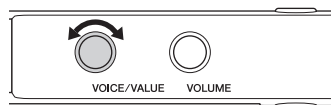

5 Press the Mode button several times until the [UTILITY] lamp lights up in orange.

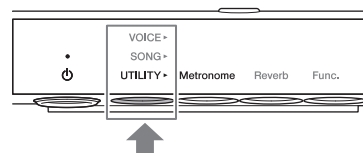

6 Press Button 3 [Func.] to enter the Function Settings.

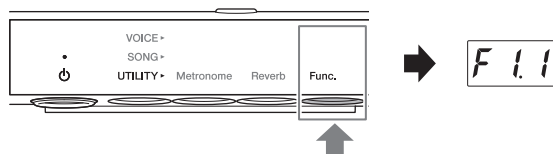

7 Rotate the [VOICE/VALUE] control to select “F7.2”

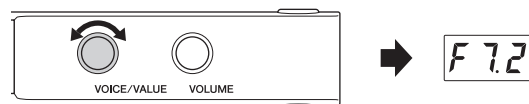

8 Press Button 3 [Func.] to call up “dEL” in the display.

After that, “n y” appears on the display.

NOTE

To cancel the copying operation, press any button other than Button 3 [Func.] while “n y” is shown.

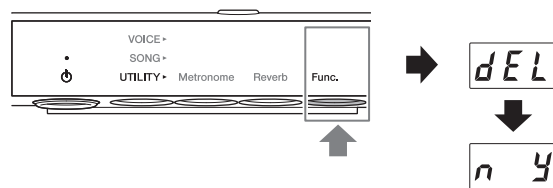

9 Press Button 3 [Func.] again to start deleting.

Dashes appears in succession on the display, indicating that the delete operation is in progress. When the operation is completed, “End” appears on the display.

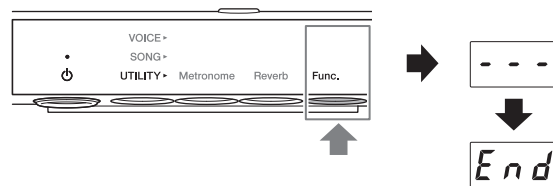

NOTICE

While dashes appear on the display in succession, never turn off the power. Doing so may corrupt the data or damage the internal memory or USB flash drive.

Using Convenient Functions (UTILITY)

This section includes the operations in the UTILITY mode. The UTILITY mode allows you to apply the Reverb effect, use the metronome, and use other various convenient functions.

Enhancing the sound with Reverb

An actual piano sounds differently depending on the size of the room, or the material of the building in which it is played. The reverberation is the major reason for this difference. Using the Reverb effect and simulating the reverberation in a concert hall, etc. gives you the feeling of the being at a live performance.

Although selecting a Voice will call up the optimum Reverb type and depth for the selected Voice, you can change these settings as desired.

- 1 Press the Mode button several times until the [UTILITY] lamp lights up in orange.

Lights up in orange

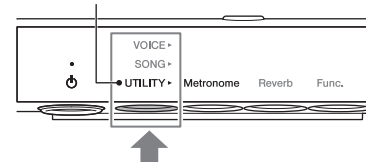

- 2 Press Button 2 [Reverb].

The current Reverb depth appears on the display.

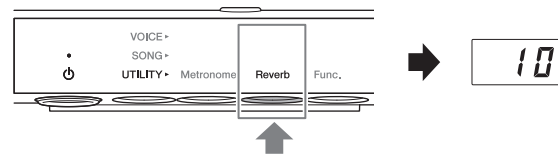

- 3 Make the desired settings as follows.

- **Adjusting the Reverb depth**

Rotate the [VOICE/VALUE] control to adjust the depth in the range of 1 – 20. Pressing the [VOICE/VALUE] control can restore the default setting of the selected Voice.

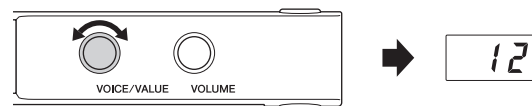

- **Turning off the Reverb**

While the Reverb depth is shown in the display, press Button 2 [Reverb]. "OFF" appears on the display and the Reverb effect for the keyboard performance is turned off.

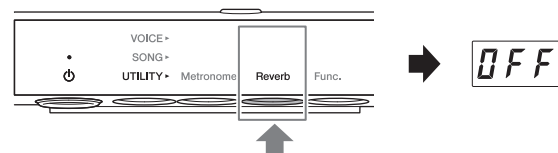

NOTE

You can also turn off the Reverb effect by setting the Reverb type to "OFF" (page 31). In this case, Reverb is not applied to Song playback, nor to the keyboard performance.

• Selecting a Reverb type

3-1 Hold down Button 2 [Reverb] for three seconds to show the current Reverb type on the display.

3-2 Rotate the [VOICE/VALUE] control to select a Reverb type. Pressing the [VOICE/VALUE] control can restore the default setting of the selected Voice. For the list of the available types, refer to “Reverb Type List” below.

3-3 Press Button 2 [Reverb] again or wait for a while without performing any operation to return to the Reverb depth display.

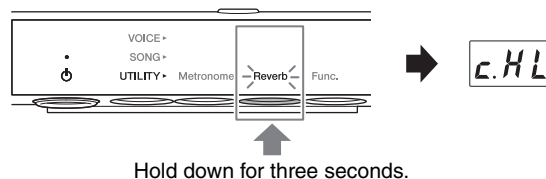

Reverb Type List

Reverb Type		Description
OFF	Off	No effect is applied.
r.HL	Recital Hall	Simulates clear reverberation in a mid-sized hall suitable for piano recital.
c.HL	Concert Hall	Simulates brilliant reverberation in a large hall for public orchestra performances.
Chn	Chamber	Simulates the elegant reverberation in a small room suitable for chamber music.
Cat	Cathedral	Simulates the solemn reverberation in a high-ceiling stone-made cathedral.
CLb	Club	Simulates the lively reverberation in a jazz club or a small bar.
PLt	Plate	Simulates the bright sound of vintage reverb equipment used in recording studios.

NOTE

- The Reverb settings are reset to the default values automatically when the power is turned off.
- When an external Song (page 20) is played back, or when the MIDI data is received (from a computer, etc.; page 50), dashes may appear on the display. This indicates that the data uses a Reverb type which is not available on this unit.

Using the metronome

The unit features a built-in metronome that helps you to practice and play with accurate tempo.

NOTE

- When a MIDI Song (page 20) is played back, the metronome plays according to the Song tempo and time signature.
- The metronome tempo and beat restore to the default settings when the power is turned off.
- The metronome volume can be adjusted via Button 3 [Func.] in the UTILITY mode (page 38).

■ Turning on/off the metronome

- 1 Press the Mode button several times until the [UTILITY] lamp lights up in orange.**

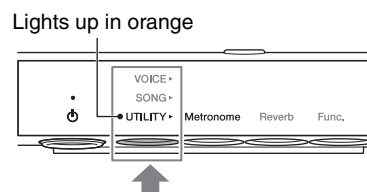

- 2 Press Button 1 [Metronome] to turn on the metronome.**

The current tempo appears on the display. While the metronome sounds, a dot at the lower right of the display flashes at the current tempo. Even when another Mode is selected, the dot keeps flashing while the metronome is playing.

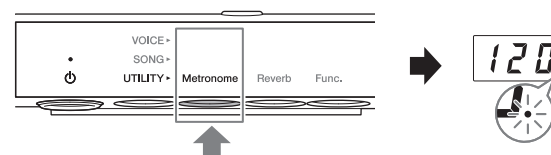

NOTE

When Button 2 [Reverb] or 3 [Func.] is selected in the UTILITY mode, you need to press Button 1 [Metronome] to switch the function before operating step 2 above.

- 3 To stop the metronome, press Button 1 [Metronome] once again.**

■ Adjusting the Tempo

- 1 Press Button 1 [Metronome] in the UTILITY mode to call up the current tempo on the display.**

- 2 Rotate the [VOICE/VALUE] control to adjust the tempo.**

The metronome tempo can be set from 5 to 500 beats per minute. Pressing the [VOICE/VALUE] control restores the default setting (120).

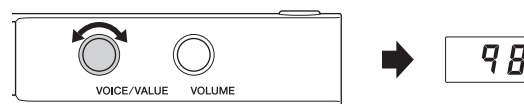

NOTE

When an Audio Song is being played back, this operation changes the playback speed (page 23). The metronome tempo does not change.

■ Selecting the time signature (Beat)

1 Press Button 1 [Metronome] in the UTILITY mode.

2 Hold down Button 1 [Metronome] for three seconds to call up the beat setting value on the display.

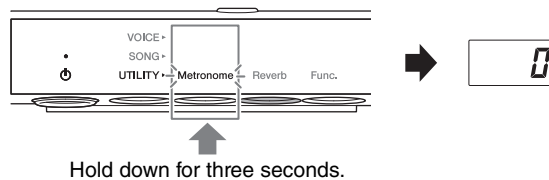

3 Rotate the [VOICE/VALUE] control to select the beat.

The beat can be selected from 0 and 2 – 6. For values other than 0, the first beat is accented with a bell sound to signal the start of a measure.

Pressing the [VOICE/VALUE] control can restore the default setting (0; no 1st beat accent).

Pressing Button 1 [Metronome] displays the tempo value.

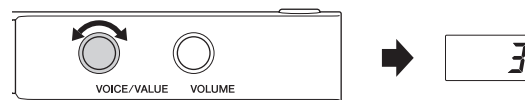

NOTE

One beat is equal to a quarter note on this unit. When playing a song written in non-quarter-note units, change the setting accordingly (for example, when playing a song in 3/2 time, set Beat to 6).

Customizing with the various Function parameters (Function settings)

In the Function settings, you can tune the instrument, adjust the metronome volume, and make a wide range of other convenient settings to customize your piano to suit your performance.

■ Function List

Function		Function No.	Page
Brilliance*		F1.1	page 36
Touch	Touch Sensitivity*	F2.1	page 36
	Fixed Velocity	F2.2	page 36
Keyboard	Transpose	F3.1	page 36
	Master Tune*	F3.2	page 37
Scale Tune	Scale Type (Temperament)	F3.3	page 37
	Base Note	F3.4	page 38
Metronome Volume*		F4.1	page 38
Song	MIDI Song/Keyboard Volume Balance*	F4.2	page 38
	MIDI Song Transpose	F4.3	page 39
	Audio Song Volume*	F4.4	page 39
Sound	Half Pedal Point*	F5.1	page 39
	Binaural On/Off*	F5.2	page 40
	VRM On/Off*	F5.3	page 40
	Damper Resonance Depth	F5.4	page 41
	String Resonance Depth	F5.5	page 41
	Aliquot Resonance Depth	F5.6	page 41
	Body Resonance Depth	F5.7	page 42
	Key-off Sample Volume	F5.8	page 42
MIDI	MIDI Transmit Channel*	F6.1	page 42
	Local Control On/Off	F6.2	page 42
File Control	Copying User Songs	F7.1	page 43
	Deleting User Songs	F7.2	page 43
	Formatting a USB flash drive	F7.3	page 43
Auto Power Off		F8.1	page 43
AUX IN Noise Gate*		F8.2	page 43
Version		F8.3	page 44
Audio Loop Back*		F8.4	page 44
Bluetooth	Bluetooth On/Off*	F8.5	page 44
	Pairing*	F8.6	page 44

Function parameter values indicated by "*" are maintained even when the power is turned off.

■ Basic Function-parameter operations

- 1** Press the Mode button several times until the [UTILITY] lamp lights up in orange.

Lights up in orange

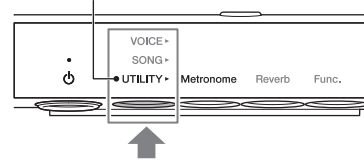

- 2** Press Button 3 [Func.] to enter the Function Settings.

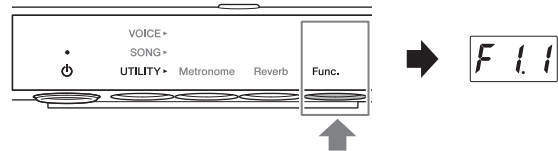

- 3** Rotate the [VOICE/VALUE] control to select the desired Function number.

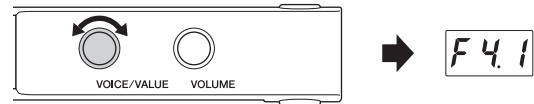

- 4** Press Button 3 [Func.] to display the parameter value.

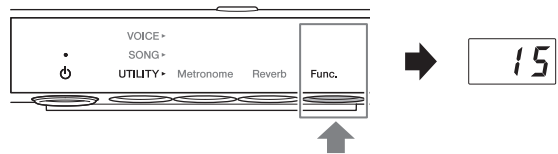

- 5** Rotate the [VOICE/VALUE] control to change the parameter value.
To continue to set other Functions, repeat the operation from step 2 above.



To exit from the Function Settings, select another mode.

■ Brilliance

F 1.1

Adjusts the timbre brilliance of the entire keyboard sound from mellow to bright.

Setting range	-2 (Mellow) – 0 (Normal) – +2 (Bright)
Default setting	0 (Normal)

■ Touch Sensitivity

F 2.1

Determines how the sound responds to your playing strength.

Setting range	-2 (Soft)	Produces relatively high volume even with light playing strength.
	-1 (Soft/Medium)	Produces high volume with moderate playing strength.
	0 (Medium)	Standard Touch Sensitivity.
	1 (Medium/Hard)	Requires moderately strong playing for high volume.
	2 (Hard)	Requires strong playing to produce high volume.
	OFF (Fixed)	No touch response. The volume level will be the same regardless of how hard you play the keys.
Default setting	0 (Medium)	

NOTE

When “OFF” (Fixed) is selected, the velocity can be set in F2.2 (Fixed Velocity).

■ Fixed Velocity

F 2.2

Determines the velocity with which the sound responds when Touch Sensitivity is set to “OFF” (Fixed).

Setting range	1 – 127
Default setting	64

■ Keyboard Transpose

F 3.1

Shifts the pitch of the entire keyboard up or down in semitone intervals to facilitate playing in difficult key signatures, and to let you easily match the pitch of the keyboard to the range of a singer or other instruments. For example, if you set this parameter to “5,” playing key C produces pitch F. In this way, you can play the F major song as if it were in C major.

Setting range	-12 – 0 – +12
Default setting	0

NOTE

Your keyboard performance data will be transmitted with the transposed note numbers while MIDI note numbers received from an external MIDI device or computer will not be affected by the Transpose setting.

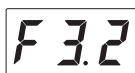
■ Master Tune

Fine tunes the pitch of the entire instrument in 0.2 Hz steps. This lets you accurately match the keyboard pitch to that of other instruments or music on a portable music player.

Setting range	A3 = 414.8 Hz – 466.8 Hz
Default setting	A3 = 440.0 Hz

NOTE

The hundreds digit is omitted for the value shown in the display (e.g., “40.2” stands for 440.2 Hz).

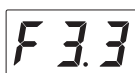
■ Scale Type (Temperament)

Modern acoustic pianos are tuned almost exclusively in equal temperaments. Likewise, this unit employs equal temperament, but you can select one of various scales for playing in custom tunings for specific historical periods or music genres.

Setting range	1 (Equal)	The pitch range of each octave is divided equally into twelve parts, with each half-step evenly spaced in pitch. This is the most commonly used tuning in music today.
	2 (Pure Major)	These tunings preserve the pure mathematical intervals of each scale, especially for triad chords (root, third, fifth). You can hear this best in actual vocal harmonies — such as choirs and a cappella singing.
	3 (Pure Minor)	
	4 (Pythagorean)	This scale was devised by the famous Greek philosopher and is created from a series of perfect fifths, which are collapsed into a single octave. The 3rd in this tuning are slightly unstable, but the 4th and 5th are beautiful and suitable for some leads.
	5 (Mean-Tone)	This scale was created as an improvement on the Pythagorean scale, by making the major third interval more “in tune.” It was especially popular from the 16th century to the 18th century. Handel, among others, used this scale.
	6 (Werckmeister)	This composite scale combines the Werckmeister and Kirnberger systems, which were themselves improvements on the mean-tone and Pythagorean scales. The main feature of this scale is that each key has its own unique character. The scale was used extensively during the time of Bach and Beethoven, and even now it is often used when performing period music on the harpsichord.
	7 (Kirnberger)	
Default setting	1 (Equal)	

■ Base Note

F 3.4

Determines the base note for the Scale selected above. When the base note is changed, the pitch of the keyboard is transposed, yet maintains the original pitch relationship between the notes. This setting is necessary when Scale Tune is set to something other than “Equal Temperament.”

Setting range	C, C#, D, Eb, E, F, F#, G, Ab, A, Bb, B
Default setting	C

NOTE

In the display, the note is followed by a high bar if sharp, and the note is followed by a low bar if flat.

C#

E_b

■ Metronome Volume

F 4.1

Adjusts the metronome volume.

Setting range	1 – 20
Default setting	15

■ MIDI Song/Keyboard Volume Balance

F 4.2

Adjusts the volume balance between the keyboard performance and the MIDI Song playback. The higher the value, the Song playback volume decreases, the lower the value, the keyboard performance volume decreases. To adjust the balance with Audio Song, adjust the Audio Song volume in F4.4 (page 39).

Setting range	-64 – 0 – +64
Default setting	0

NOTE

Some PianoSoft Songs have their own volume balance settings. These settings take priority to the balance setting here.

■ Song Transpose

F 4.3

Shifts the pitch of the MIDI Song or Audio Song up or down in semitone intervals. For example, if you set this parameter to “5,” the note of key C is played back in pitch F. In this way, the F major song is played back as if it were in C major.

Setting range	-12 – 0 – +12
Default setting	0

NOTE

- MIDI note numbers received from an external MIDI device or computer will not be affected by the Transpose setting.
- Applying transpose to an Audio Song may change its tonal characteristics.

■ Audio Song Volume

F 4.4

Adjusts the volume of Audio Song playback.

Setting range	1 – 20
Default setting	16

■ Half Pedal Point

F 5.1

You can set the degree to which pressing the damper pedal applies the half-pedal effect. The larger the value, the wider the half-pedal range. Larger values give you greater leeway in controlling the half-pedal effect.

Setting range	-2 – 0 – +4
Default setting	0

Half-pedal function

This function allows the sustain length to vary depending on how far the pedal is pressed. The farther you press the pedal, the more the sound sustains. For example, if you press the damper pedal and all notes you are playing sound a bit murky and loud with too much sustain, you can release the pedal half way to subdue the sustain (murkiness).

■ Binaural On/Off

F5.2

Turns the Binaural function on or off. When this function is on, the sound from this instrument changes to the sound of Binaural Sampling or the sound enhanced with the Stereophonic Optimizer (page 19), allowing you to enjoy more realistic sound even when listening with headphones.

Setting range	On, OFF
Default setting	On

Since the sound of Binaural Sampling and the sound enhanced with the Stereophonic Optimizer are optimized for listening with headphones, we recommend that you set this function to “OFF” in the following situation.

You should turn these functions off when:

- Playing the sound of this instrument with an external powered speaker system or a mixer, while monitoring the sound output from this instrument on connected headphones.
- Making an Audio Recording (page 24) and then playing the recorded Audio Song through speakers. (If you want to play the Audio Song recorded on this instrument through speakers, make sure to turn these functions off before using Audio Recording.)

NOTE

Before connecting an external audio device, be sure to read “Connecting to external audio devices” (page 47).

■ VRM On/Off

F5.3

Turns the VRM effect (see below) on/off. When set to on, the VRM effect is applied only to piano Voices (PF.1 – PF.5). Damper Resonance, String Resonance and Aliquot Resonance produced by VRM can be adjusted separately in F5.4 – F5.7.

Setting range	On, OFF
Default setting	On

VRM (Virtual Resonance Modeling) technology

On an actual acoustic piano, if you press the damper pedal and play a key, not only does the string of the pressed key vibrate, it also causes other strings and the soundboard to vibrate, with each influencing the rest, creating a rich and brilliant resonance that sustains and spreads. The VRM (Virtual Resonance Modeling) technology featured in this unit reproduces the complicated interaction of both string and soundboard resonance faithfully using a virtual musical instrument (physical modeling), and makes the sound more like a real acoustic piano. Since instantaneous resonance is made at the moment according to the state of the keyboard or pedal, you can vary the sound expressively by changing the timing of your pressing the keys, and the timing and depth of your pressing the pedal.

■ Damper Resonance Depth

F 5.4

Determines the depth of the resonance effect produced by VRM which is applied when the damper pedal is pressed. This parameter is effective only when VRM is on (page 40) and one of the piano Voice is selected.

Setting range	0 – 10
Default setting	5

■ String Resonance Depth

F 5.5

Determines the depth of the string resonance effect produced by VRM which is applied when a note on the keyboard is pressed. This parameter is effective only when VRM is on (page 40) and one of the piano Voice is selected.

Setting range	0 – 10
Default setting	5

■ Aliquot Resonance Depth

F 5.6

Determines the depth of the Aliquot resonance effect produced by VRM which is applied when you release your hands from the keyboard. This parameter is effective only when VRM is on (page 40) and one of the piano Voice is selected.

Setting range	0 – 10
Default setting	5

What is Aliquot?

Aliquot is a stringing method for pianos that uses extra, un-struck strings in the upper octaves to enhance the tone. These strings sympathetically vibrate with other strings in an acoustic piano, resonating with overtones, and adding richness, brilliance and complex color to the sound. Since they do not have a damper, they will continue sounding even after you release your hands from the keyboard.

■ Body Resonance Depth

F5.7

Determines the depth of the Body resonance effect which simulates the resonance of the piano itself, i.e. soundboard, the sides, the frame and so on. This parameter is effective only when VRM is on (page 40) and one of the piano Voice is selected.

Setting range	0 – 10
Default setting	5

■ Key-off Sampling Volume

F5.8

Determines the volume of the key-off sampling sound (simulated the subtle sound that occurs when you release a key) which is available for some Voices. For Voices to which this effect is applied, refer to the Voice List (page 60).

Setting range	0 – 10
Default setting	5

■ MIDI Transmit Channel

F6.1

Determines the MIDI channel with which the MIDI data of the keyboard performance will be transmitted to the external MIDI devices. When this parameter is set to “OFF,” MIDI data is not transmitted.

Setting range	1 – 16, OFF
Default setting	1

■ Local Control

F6.2

Determines whether the sound played on the keyboard is produced from the tone generator of this instrument or not.

Setting range	On	The keyboard performance data is transmitted to the internal tone generator of this instrument and it produces the sound.
	OFF	The keyboard performance data is not transmitted to the internal tone generator of this instrument. This means that even if you play the keyboard, this instrument will produce no sound. Instead, the keyboard data can be transmitted via MIDI to a connected external MIDI device, which can produce the sound.
Default setting	On	

■ Copying User Songs

F 7.1

Copies the User Songs saved in the internal memory to the connected USB flash drive. For details, refer to “Copying User Songs in the internal memory to a USB flash drive” on page 27.

■ Deleting User Songs

F 7.2

Delete the User Songs in the internal memory or the connected USB flash drive. For details, refer to “Deleting User Songs” on page 28.

■ Formatting a USB Flash Drive

F 7.3

Formats or initialize the USB flash drive connected to the USB [TO DEVICE] terminal. For details, refer to “Formatting a USB flash drive” on page 46.

NOTICE

Executing the Format operation will delete all data saved in the USB flash drive. Save important data to a computer or another storage device.

■ Auto Power Off

F 8.1

Disables or enables the Auto Power Off function (page 16).

Setting range	On	Enables the Auto Power Off function. The power is automatically turned off if the instrument is not operated for approximately 30 minutes.
	OFF	Disables the Auto Power Off function. Turn off the power by pressing the [⏻] (Standby/On) switch.
Default setting	On	

NOTICE

When the instrument is communicating with other devices or the Songs are played back, the power will not be turned off automatically. Make sure to turn off the power by pressing the [⏻] (Standby/On) switch when the instrument is not in use.

■ AUX IN Noise Gate

F 8.2

The AUX IN Noise Gate function conveniently cuts unwanted noise from the sound input via the [AUX IN] jack. By default, this is set to on, however, this may result in necessary sounds also being cut, such as the soft decay sound of a piano. To avoid this, set this function to off.

Setting range	On, OFF
Default setting	On

■ Version



The firmware version of this unit is shown in the display.
Example: version 1.00



■ Audio Loop Back



Determines whether audio sound input from the connected computer or smart device (via the USB Audio Interface function, wireless connection or Bluetooth Audio function; page 50) is output to a computer or a smart device or not, along with the performance played on the instrument. To output the audio input sound, set Audio Loop Back to “On.”

For example, if you want to record the audio input sound as well as the sound played on the instrument to a computer or the smart device, set this to “On.” If you intend to record only the sound played on the instrument to a computer or smart device, set this to “OFF.”

Setting range	On, OFF
Default setting	On

NOTICE

If you are using a DAW (digital audio workstation) application with this instrument, set the Audio Loop Back to off. Otherwise, a loud sound may occur, depending on the settings of the computer or the application software.

NOTE

- The playback sound of an Audio Song on this instrument is also output to a computer or smart device when this is set to “On,” while the sound is not output when this is set to “OFF.”
- With Audio Recording on this instrument, the audio input sound from the connected computer or smart device is recorded when this is set to “On,” while the sound is not recorded when this is set to “OFF.”

■ Bluetooth On/Off



Turns on or off the Bluetooth function. For details, refer to “Turning the Bluetooth function on/off” on page 53.

■ Pairing



Register the Bluetooth-equipped device on this instrument. While “F8.6” is shown in the display, press Button 3 [Func.] to enable the Pairing mode on the instrument. After that, make settings on the Bluetooth equipped-device. For detailed instructions, refer to step 3 in “Pairing with Bluetooth-equipped devices” on page 52.

Connecting to Other Devices

⚠ CAUTION

Before connecting the instrument to other electronic components, turn off the power to all the components. Also, before turning any components on or off, set all volume levels to minimum (0). Otherwise, damage to the components, electrical shock, or even permanent hearing loss may occur.

Connecting USB devices

You can connect a USB flash drive or a USB wireless LAN adaptor (sold separately) to the USB [TO DEVICE] terminal. You can record your performance to the USB flash drive (page 24), or you can connect the instrument to a smart device via wireless LAN (page 51).

Precautions when using the USB [TO DEVICE] terminal

This instrument features a built-in USB [TO DEVICE] terminal. When connecting a USB device to the terminal, be sure to handle the USB device with care. Follow the important precautions below.

NOTE

For more information about the handling of USB devices, refer to the owner's manual of the USB device.

■ Compatible USB devices

- USB flash drive
- USB hub
- USB wireless LAN adaptor (UD-WL01; may not be available depending on your area)

Other USB devices such as a USB hub, computer keyboard or mouse cannot be used.

The instrument does not necessarily support all commercially available USB devices. Yamaha cannot guarantee operation of USB devices that you purchase. Before purchasing a USB device for use with this instrument, please visit the following web page: <http://download.yamaha.com/>

Although USB devices 2.0 to 3.0 can be used on this instrument, the amount of time for saving to or loading from the USB device may differ depending on the type of data or the status of the instrument. USB 1.1 devices cannot be used on this instrument.

NOTICE

The rating of the USB [TO DEVICE] terminal is a maximum of 5V/500mA. Do not connect USB devices having a rating above this, since this can cause damage to the instrument itself.

■ Connecting a USB device

When connecting a USB device to the USB [TO DEVICE] terminal, make sure that the connector on the device is appropriate and that it is connected in the proper direction.

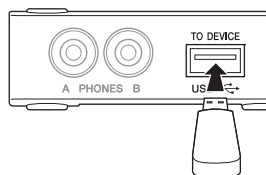

NOTICE

- Avoid connecting or disconnecting the USB device during playback/recording, or when accessing the USB device. Failure to observe this may result in "freezing" of the operation of the instrument or corruption of the USB device and the data.
- When connecting then disconnecting the USB device (and vice versa), make sure to wait a few seconds between the two operations.

NOTE

- If you intend to connect two or three devices at the same time to a terminal, you should use a bus-powered USB hub. Only one USB hub can be used. If an error message appears while using the USB hub, disconnect the hub from the instrument, then turn on the power of the instrument and re-connect the USB hub.
- Do not use an extension cable when connecting a USB device.

Using USB Flash Drives

By connecting the instrument to a USB flash drive, you can save data you've recorded to the connected device, as well as read data from the connected USB flash drive.

■ Number of USB flash drives that can be used

Only one USB flash drive can be connected to the USB [TO DEVICE] terminal. (If necessary, use a USB hub. The number of USB flash drives that can be used simultaneously with musical instruments even when a USB hub is used is only one.)

■ Formatting a USB flash drive

You should format the USB flash drive only with this instrument (page 46). A USB flash drive formatted on another device may not operate properly.

NOTICE

The format operation overwrites any previously existing data. Make sure that the USB flash drive you are formatting does not contain important data.

■ To protect your data (write-protect)

To prevent important data from being inadvertently erased, apply the write-protect provided with each USB flash drive. If you are saving data to the USB flash drive, make sure to disable write-protect.

■ Turning off the instrument

When turning off the instrument, make sure that the instrument is NOT accessing the USB flash drive by playback/recording. Failure to do so may corrupt the USB flash drive and the data.

■ Formatting a USB flash drive

Formats or initialize the USB flash drive connected to this instrument. When a “UnF” appear on the display, indicating that the USB flash drive has not been formatted, format the drive.

NOTICE

Executing the Format operation will delete all data saved in the USB flash drive. Save important data to a computer or another storage device.

1 Connect the USB flash drive to the USB [TO DEVICE] terminal.

2 Press the Mode button several times until the [UTILITY] lamp lights up in orange.

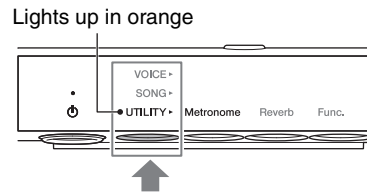

3 Press Button 3 [Func.] to enter the Function Settings.

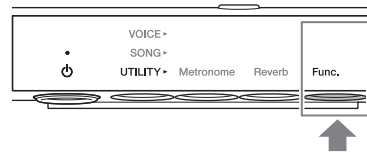

4 Rotate the [VOICE/VALUE] control to select the function number “F7.3.”

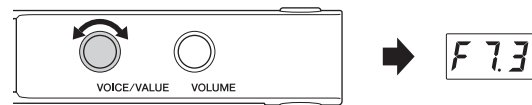

5 Press Button 3 [Func.] to call up “For” (Format) in the display.

“n y” will appear subsequently.

NOTE

While “n y” is shown in the display, you can cancel the Format operation by pressing a button other than Button 3 [Func.].

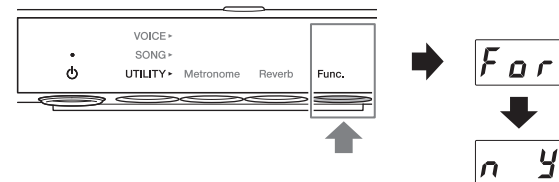

6 When “n y” appears, press Button 3 [Func.] to execute the Format operation.

Dashes appear in succession on the display, indicating that Formatting is in progress. When the operation is completed, “End” appears on the display

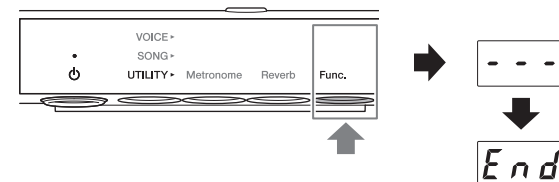

NOTICE

While dashes appear in succession on the display, never turn off the power or disconnect the USB flash drive. Doing so may corrupt the data on the USB flash drive, and the Format operation will not be executed properly.

Connecting to external audio devices

By connecting the AUX OUT jacks or the [AUX IN] jack to other audio devices, the keyboard performance on this instrument can be output to the external device, or the audio sound played on the external device can be input to this instrument.

NOTE

Use audio cables and adaptor plugs having no (zero) resistance.

■ Connecting to the AUX OUT [R]/[L/L+R] jacks

The AUX OUT [R]/[L/L+R] jacks are the standard phone jacks.

When connected to an audio recorder (such as a mini stereo system or IC recorder):

You can record performances played using the Silent Piano™ function.

When connected to powered speakers or a stereo system:

You can listen to performances played using the Silent Piano™ function on the speaker. The signal output from this jack is the same sound as that heard when listening through headphones.

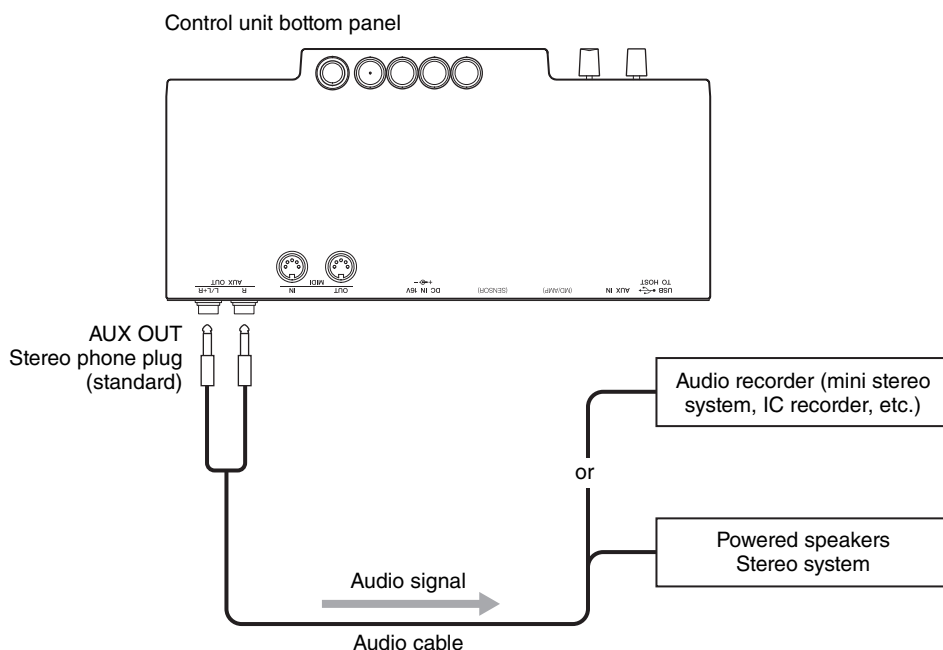

NOTICE

To avoid damage to the devices, first turn on the power to the instrument, then to the external device. When turning off the power, first turn off the power to the external device, then to the instrument.

NOTE

- You can use the [VOLUME] control on this unit to adjust the output volume from the AUX OUT jacks.
- Use only the AUX OUT [L/L+R] jack for connection with a mono device.
- We recommend that you turn the Binaural (or Stereophonic Optimizer) function off when you monitor the sound output from this instrument on connected headphones (pages 19 and 40).

■ Example of using the [AUX IN] jack

The [AUX IN] jack is a stereo mini jack.

By connecting the [AUX IN] jack to other sound modules or playback devices (such as portable music players), you can use the Silent Piano™ function together with the sound received from the connected devices.

You can use the [VOLUME] control on this unit to simultaneously adjust the volume of its electronic sound and the sound received through its [AUX IN] jack. To set a proper balance of the levels, adjust the output volume on the connected device.

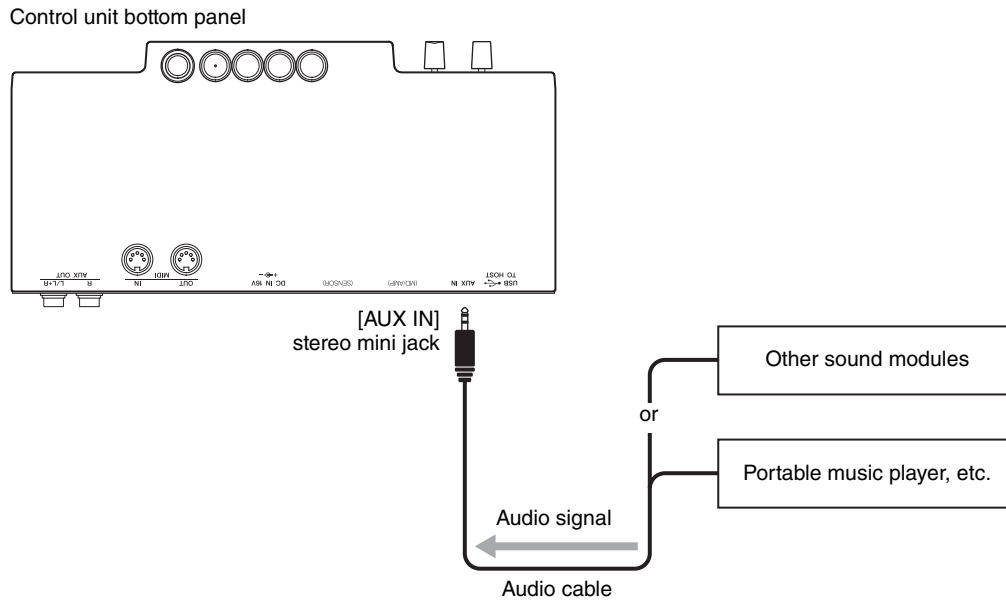

NOTICE

Do not route the output from the AUX OUT jacks to the AUX IN jack. If you make this connection, the signal input at the [AUX IN] jack is output from the AUX OUT jacks. These connections could result in a feedback loop that will make normal performance impossible, and may even damage the equipment.

NOTE

By default, this instrument uses a convenient Noise Gate effect to cut unwanted noise from the sound input via the [AUX IN] jack. However, this may result in necessary sounds also being cut, such as the soft decay sound of a piano. To avoid this, set the Noise Gate to off (page 43).

Connecting to external MIDI devices

By connecting a MIDI device, you can control the external MIDI device from this unit or vice versa. Use the MIDI terminals and standard MIDI cables to connect external MIDI devices (keyboard, synthesizer, sequencer, etc.).

NOTE

- Demo Song data and Preset Song data cannot be transmitted.
- Since MIDI data that can be transmitted or received varies depending on the type of MIDI device, check the “MIDI Reference” on the website to find out what MIDI data and commands your devices can transmit or receive.

■ Connecting to the MIDI [OUT] jack

When connected to another MIDI device:

You can reproduce the Silent Piano™ performances using sound modules such as synthesizers and other MIDI devices.

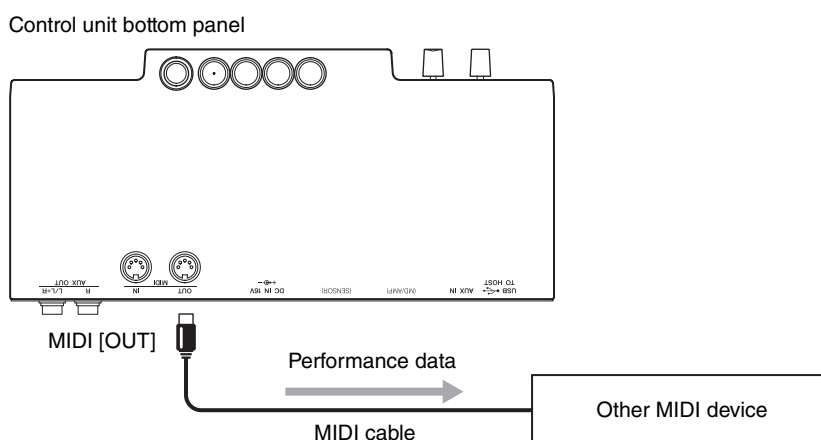

■ Connecting to the MIDI [IN] jack

When connected to a sequencer:

You can use the sound module of this unit to reproduce performance data received from connected devices.

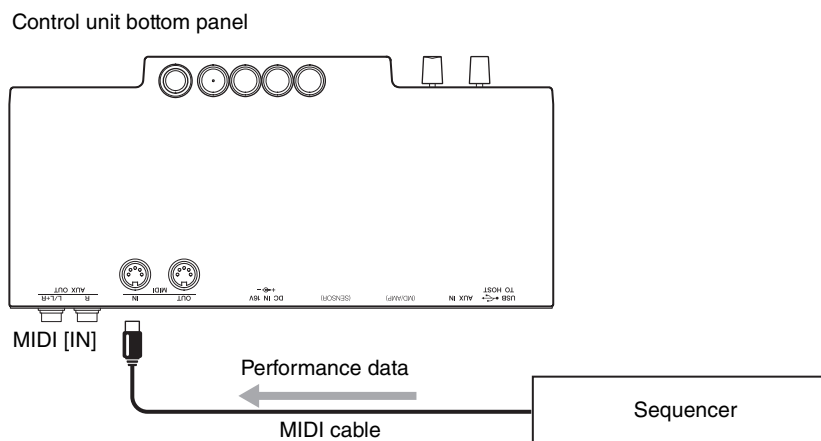

Connecting to a computer/smart device

Connecting this instrument to a computer or a smart device expands the possibility.

What you can do by connecting to a computer/smart device:

- Transmitting and receiving audio data (USB Audio Interface function, page 51)
- Using a smart device app (page 51)
- Listening to the audio data in the smart device through this instrument (Bluetooth Audio function, page 52)
- Transmitting and receiving MIDI data
- Saving the Song recorded on this instrument to the computer

NOTE

For details on transmitting/receiving MIDI data or saving the Song to a computer, refer to the “Computer-related Operations” on the website.

Connection example

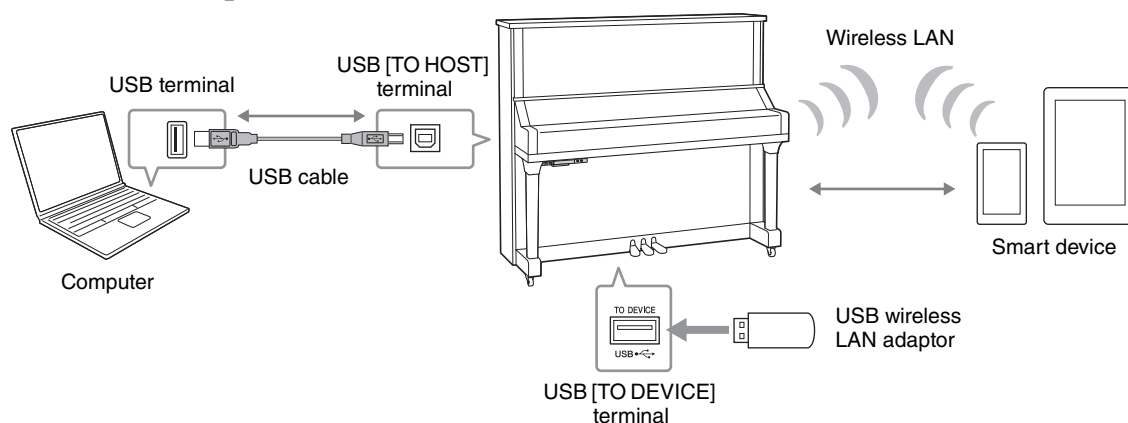

For details on connecting to a computer or transferring the MIDI Song to the computer, refer to the “Computer-related Operations” on the website (page 10).

NOTICE

- Do not connect this product to public Wi-Fi and/or Internet directly. Only connect this product to the Internet through a router with strong password-protections. Consult your router manufacturer for information on security best practices.
- Use an AB type USB cable of less than 3 meters. USB 3.0 cables cannot be used.
- If you are using a DAW (digital audio workstation) application with this instrument, set the Audio Loop Back (page 44) to off. Otherwise, a loud sound may occur, depending on the settings of the computer or the application software.
- Do not place your computer or smart device in an unstable position. Doing so may cause the device to fall and result in damage.

NOTE

- When using a USB cable to connect the instrument to your computer or smart device, make the connection directly without passing through a USB hub.
- For information on setting up your sequence software, refer to the owner’s manual of the relevant software.
- When transmitting or receiving audio signals by using the computer operated by Windows, the Yamaha Steinberg USB Driver should be installed to the computer. For details, refer to the “Computer-related Operations” on the website.
- Before using the USB [TO DEVICE] terminal, be sure to read “Connecting USB devices” on page 45.
- When you use the instrument along with an application on your smart device, we recommend that you set your device to not emit radio waves (for example, by setting “Airplane Mode” to on).
- The instrument will begin transmission a short time after the computer or smart device is connected.

■ Transmitting/receiving audio data (USB Audio Interface function)

By connecting a computer or a smart device to the USB [TO HOST] terminal via a USB cable, digital audio data can be transmitted/received, giving you the following advantages:

- **Playing back audio data with high sound quality**

This gives you direct, clear sound in which the sound quality has less noise and deterioration than that from the [AUX IN] jack.

- **Recording performance on the instrument as audio data by using a recording software or a music production software**

The recorded audio data can be played back on the computer or smart device.

NOTE

- The volume of the audio sound input can be adjusted from a computer or smart device.
- You can set whether audio sound input from the connected computer or smart device is output to a computer or smart device or not, along with the performance played on the instrument. For details, refer to “Audio Loop Back” on page 44.

■ Using a smart device app

By using the compatible smart device app, you can take advantage of convenient functions and get more enjoyment out of this instrument. Especially, “Smart Pianist” (available as a free download) enables you to conveniently control the various functions of this instrument from the smart device. For information about the compatible apps and smart devices, access the web page of the respective apps on the following page:

<http://www.yamaha.com/kbdapps/>

This section explains how to connect a smart device by using the separately sold USB wireless LAN adaptor UD-WL01. For connections with other methods, refer to the “iPhone/iPad Connection Manual” on the website.

Connection with the USB wireless LAN adaptor (UD-WL01*)

*UD-WL01 (sold separately) may not be available depending on your area.

There are two types of connections with the USB wireless LAN adaptor (UD-WL01) described below.

- **Connecting by the Access Point mode**

The Access Point mode allows you to directly connect the USB wireless LAN adaptor and a smart device, without the need for using an access point. You can use this mode when there is not any access point available for connection to the instrument, or when it is unnecessary to connect to another network while a smart device is connected to the instrument.

Access point

An “access point” refers to a device which acts as a base station when data is transmitted/received via a USB wireless LAN adaptor. Some access points are combined with router or modem functions.

1 Initialize the instrument (if necessary; see page 54).

2 Connect the UD-WL01 to the USB [TO DEVICE] terminal.

3 Connect a smart device to the instrument (as an access point).

NOTE

When you change the Infrastructure mode (see the right column) to the Access Point mode, initialize the instrument (page 54).

- **Connecting by the Infrastructure mode (automatic setup by WPS)**

The Infrastructure mode uses an access point for data communication between a USB wireless LAN adaptor and a network. You can use this mode when you connect to another network while a smart device is connected to the instrument.

1 Connect the UD-WL01 to the USB [TO DEVICE] terminal.

2 Hold down the WPS button on the UD-WL01 for three seconds.

The message as follows appears on the display, indicating the instrument is in standby for the connection.



3 Press the WPS button on your access point within two minutes after step 2.

NOTE

Once you connect by the Infrastructure mode, you can connect to a network automatically without executing steps 2 and 3.

■ Listening to audio data from a smart device through this instrument (Bluetooth Audio function)

This instrument is equipped with Bluetooth functionality. You can input the sound of the audio data saved in a Bluetooth-equipped device, such as a smart phone, to this instrument and listen to it through the built-in speaker of the instrument.

*Bluetooth

Bluetooth is a technology for wireless communication between devices within an area of about 10 meters (33 ft.) employing the 2.4 GHz frequency band. In this manual, “Bluetooth-equipped device” means a device that can transmit the audio data saved in it to the instrument using the Bluetooth function via wireless communication; for example, smart phone, digital audio player, etc. For proper operation, the device must be compatible with A2DP (Advanced Audio Distribution Profile).

Before using the Bluetooth function, be sure to read “About Bluetooth communications” on page 9.

Pairing with Bluetooth-equipped devices

If you wish to connect your Bluetooth-equipped device to the instrument via Bluetooth, the device needs to be paired with the instrument first. Once the Bluetooth-equipped device has been paired with this instrument, there is no need to perform pairing again.

Pairing

“Pairing” means to register Bluetooth-equipped devices on this instrument, and establish the mutual recognition for wireless communication between the two.

NOTE

- Only one Bluetooth-equipped device can be connected to this instrument at a time (although up to 8 devices can be paired to this instrument). When pairing with the 9th Bluetooth-equipped device has succeeded, pairing data for the device with the oldest connection date will be deleted.
- Pairing can also be operated in the Function “F8.6” (page 44).

1 Press the Mode button several times until the [UTILITY] lamp lights up in orange.

NOTE

- When the Bluetooth function of this instrument is set to off (Bluetooth lamp is off), pairing cannot be established when executing the pairing operation. Make sure to set the Bluetooth function to on (page 53), and then start pairing.
- When no Bluetooth-equipped device is connected, the Bluetooth lamp lights up in white in the UTILITY mode, and turns off in other modes.

Lights up in orange

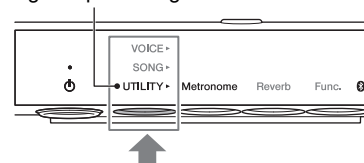

2 Hold down Button 3 [Func.] for three seconds.

The instrument will enter into Pairing mode. At the same time the Bluetooth lamp will flash and a “bt” message will appear on the display.

NOTE

To cancel the pairing, press Button 3 [Func.] while “bt” is shown in the display.

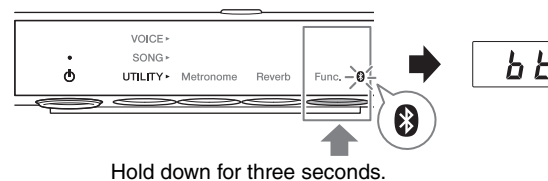

3 On your Bluetooth-equipped device, set the Bluetooth function to on and select “YAMAHA_SH2_TA2” from the connection list.

For details, refer to the Bluetooth-equipped device owner’s manual.

After pairing is completed, the Bluetooth lamp will light up in blue and the “bt” message will disappear.

NOTE

- Make sure to complete the settings on the Bluetooth-equipped device within 5 minutes. After 5 minutes elapses, the Pairing mode ends automatically and the Bluetooth lamp turns off.
- If you are required to enter a passkey, enter the numerals “0000.”

4 Play back audio data on your Bluetooth-equipped device to confirm that the built-in speakers of this unit can output the audio sound.

When you turn on this unit the next time, the last connected Bluetooth-equipped device will be connected to this instrument automatically, if the Bluetooth function of the device and the instrument is set to on. If it is not connected automatically, select the model name of the instrument from the connections list on the device.

NOTE

You can adjust the volume of the sound input via Bluetooth by the [VOLUME] control on this instrument. To adjust the volume balance between your keyboard performance and the input sound via Bluetooth, adjust the volume on the Bluetooth-equipped device.

■ Turning the Bluetooth function on/off

By default, the Bluetooth function will be set to on right after turning the instrument's power on. However, you can set the function to off when you want to disconnect the connection between the instrument and the Bluetooth-equipped device, or when you want to try to connect the device to the instrument again, etc.

- 1 Press the Mode button several times until the [UTILITY] lamp lights up in orange.

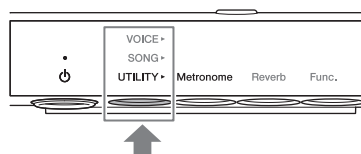

- 2 Press Button 3 [Func.] to enter the Function Settings.

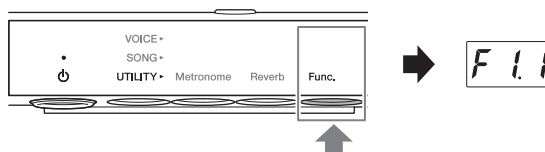

- 3 Rotate the [VOICE/VALUE] control to select the Function number "F8.5."

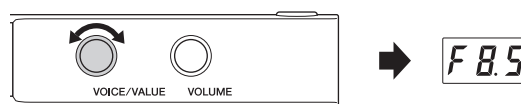

- 4 Press Button 3 [Func.] to display the parameter value.

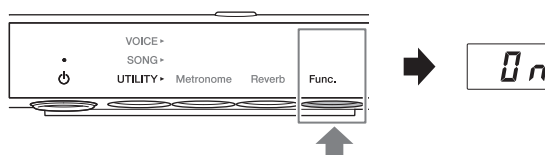

- 5 Rotate the [VOICE/VALUE] control to select "On" or "OFF."

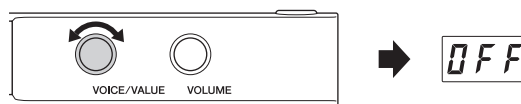

To exit from the Function Settings, select another mode.

Using Other Functions

Backup data and initialization

The following settings, referred to as Backup data, are automatically saved to the internal memory of this unit. The Backup data and the User Song and External Song data will be maintained even if the power is turned off.

- Brilliance..... page 36
- Touch Sensitivity page 36
- Master Tune page 37
- Metronome Volume page 38
- MIDI Song/Keyboard Volume Balance..... page 38
- Audio Song Volume page 39
- Half Pedal Point..... page 39
- Binaural on/off..... page 40
- VRM on/off page 40
- MIDI Transmit Channel..... page 42
- AUX IN Noise Gate on/off..... page 43
- Audio Loop Back on/off..... page 44
- Auto Power Off on/off..... page 43
- Bluetooth function on/off page 44
- Bluetooth Pairing information page 44
- Character Code..... page 55

■ Initializing the instrument (Clearing the Backup data)

While holding down the C7 key, turn on the power by pressing the [⏻] (Standby/On) switch. “CLr” appears on the display and the Backup data (with the exception of “Character Code” and “Bluetooth Paring information”) will be initialized. Note that User Songs and External Songs are not erased.

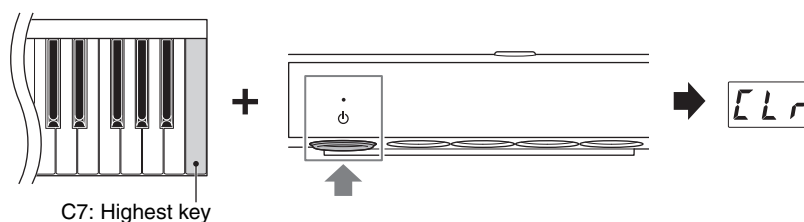

NOTICE

While “CLr” is shown in the display, never turn off the power. Doing so may delete the User Song and External Song data, or corrupt the Backup data.

NOTE

If this instrument somehow becomes disabled or malfunctions, turn off the power to the instrument, then perform the initialization procedure.

Setting the Character Code for file names

If the Song cannot be called up, you may need to select the appropriate Character Code which is compatible with the file/folder name from the following two settings.

Setting range	Int (International)	For playing back Songs with names using western European characters (including umlaut or diacritic marks).
	JA (Japanese)	For playing back Songs with names using Japanese characters and alphabets (excluding umlaut or diacritic marks).
Default setting	Int	

■ To set to International

While holding down Button 2, turn on the power by pressing the [⏻] (Standby/On) switch. International is selected, and “Int” appears on the display.

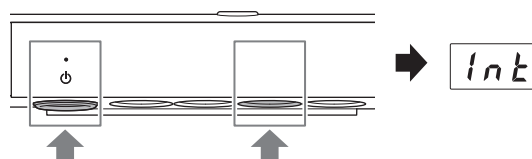

■ To set to Japanese

While holding down the Mode button and Button 2, turn on the power by pressing the [⏻] (Standby/On) switch.

Japanese is selected, and “JA” appears on the display.

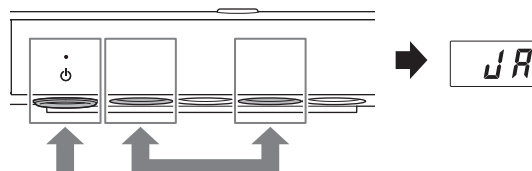

NOTE

The setting here is maintained even when the power is turned off.

Appendix

Message List

Message	Descriptions
<i>bt</i>	The instrument is standing by for Bluetooth pairing. While this message is shown, you cannot operate the instrument.
<i>CLr</i>	Displayed while the instrument is initialized. Do not turn the power off while this message is shown.
<i>con</i>	Displayed when Musicsoft Downloader is used on the connected computer, or when an app such as Smart Pianist is used on the connected smart device such as an iPhone and iPad. While this message is shown, you cannot operate the instrument.
<i>E01</i>	Displayed when the Character Code setting (page 55) is not appropriate for the file name of the Song which you are selecting. Change the Character Code setting.
	Displayed when the data format is not compatible with this instrument, or the data has some other problems. This Song cannot be selected.
	Displayed when no USB flash drive can be found, or a problem has occurred in the USB flash drive. Disconnect and connect the device again, then execute the operation. If this message appears repeatedly even when there aren't any other likely problems, the USB flash drive may be damaged.
	The Song you have selected cannot be copied or deleted on this instrument. Copy or delete these types of Songs on a computer.
	The memory or the number of the files in the copy destination USB flash drive is full. Remove any unnecessary files in the USB flash drive.
<i>E02</i>	Indicates that the USB flash drive is protected.
<i>E03</i>	Displayed when the memory of the USB flash drive becomes full, or the number of files and folders exceeds the system limit.
<i>E04</i>	Displayed when Audio Song playback or recording has failed. If you are using a USB flash drive to which data has already been stored or deleted a number of times, first make sure that the device does not contain important data, then format it (page 46) and connect to the instrument again.
<i>EE1</i>	A malfunction has occurred in the instrument. Contact your nearest Yamaha dealer or authorized distributor.
<i>EEE</i>	A malfunction has occurred in the instrument. Contact your nearest Yamaha dealer or authorized distributor.
<i>End</i>	Displayed when the current operation is completed.
<i>EnP</i>	The memory of the instrument or the USB flash drive is running out. We recommend that you remove any unnecessary User Songs (page 28) to ensure sufficient memory capacity before start recording.
<i>FUL</i>	The operation could not be completed because the instrument's internal memory or the USB flash drive is nearly full. If this message is shown while recording, your performance data may not be correctly saved.
<i>ny</i>	Confirms whether each operation is executed or not.
<i>Pro</i>	Displayed when you try to overwrite or delete a protected Song or read-only file.
<i>UnF</i>	Displayed when an unformatted USB flash drive is connected. First make sure that the device does not contain important data, then format it (page 46).
<i>Uoc</i>	Communication with the USB flash drive has been shut down because of overcurrent to the USB flash drive. Disconnect the USB flash drive from the [USB TO DEVICE] terminal, then turn on the power of the instrument again.

Message	Descriptions
UU1	Communication with the USB flash drive has failed. Remove the USB flash drive and make the connection again. If the message appears even when the USB flash drive is connected properly, the USB flash drive may be damaged.
UU2	This USB flash drive is not supported on this instrument, or too many USB flash drives may have been connected. Refer to "Connecting USB devices" (page 45) for information on the USB flash drive connection.
WPS	The instrument is in Access Point mode and standing by for connection to an access point by WPS (page 51). While this message is shown, you cannot operate the instrument.
W.P.S.	A malfunction occurred in the instrument while it was standing by for connection to an access point by WPS (page 51). Reconnect the UD-WL01 (sold separately) to the instrument and try to connect to the access point by WPS again.

* When an operation (such as saving or data transfer) is in progress, the display shows a sequence of flashing dashes.

* Press any button to exit from these message displays.

Troubleshooting

If you have problems with the unit, here are a few troubleshooting tips. If you cannot solve the problem easily yourself, consult your Yamaha piano dealer. DO NOT attempt to repair the piano or the AC adaptor yourself.

Problem	Cause	Solution
The power does not turn on.	The AC adaptor may not be plugged in correctly.	Insert the AC adaptor firmly into the [DCIN 16V] jack and AC outlet (page 15).
The power is automatically turned off.	This is normal and due to the Auto Power Off function.	If necessary, disable the Auto Power Off function (pages 16 and 43).
The overall volume is low, or no sound is heard.	The [VOLUME] control may be turned to the far left position.	Adjust the volume to an optimal level (page 17).
	Local Control is set to off.	Make sure that Local Control (page 42) is on.
The acoustic piano emits sound when playing with the Silent Piano™ function active.	Playing with extreme force may result in sound being emitted from the acoustic piano.	Moderate the strength of your playing.
The balance or volume varies between the included headphones and the commercially available headphones.	Headphone properties differ depending on their type, so different headphones may have different balance or volume characteristics.	Use the same type of headphones for optimum performance.
A rattling sound from the piano body can be heard when playing with the Silent Piano™ function.	This is not a fault. It is the sound of the acoustic piano's keystroke.	
When playing a rapid series of notes with the Silent Piano™ function, a sound louder than expected (considering playing strength) occurs.	This is not a fault. The structure of the Silent Piano™ causes this to occur in some cases.	
Sound is not output properly or evenly.	Since the keyboard was pressed when the power is turned on, the keyboard position is detected incorrectly.	Turn off the power and turn it on again to reset the function. Do not touch any keys when turning the power on.
No Reverb effect is applied to the sound.	The Reverb depth may be set to minimum.	Increase the Reverb Depth to apply an appropriate amount of Reverb (page 30).
The sound lingers excessively.	The Reverb depth or the Damper Resonance effect depth may be set to an excessive level.	Set these parameters to an appropriate level (pages 30 and 41).
Noise is heard from the headphones or speakers.	The noise may be due to interference caused by the use of a mobile phone in close proximity to the instrument.	Turn the mobile phone off, or use it away from the instrument.
	The headphones or speakers may not be connected correctly.	Connect the headphones or speakers to the corresponding jacks firmly (pages 16 and 47).
	Noise can be heard when you use the instrument along with the application on your smart device, such as an iPhone and iPad.	When you use the instrument along with a smart device, we recommend that you set "Airplane Mode" to on and then the Wi-Fi/Bluetooth setting to on in order to avoid noise caused by communication.
The pitch of this instrument is different from that of other instruments.	The pitch is different depending on the instrument.	You can adjust the pitch of this instrument to match that of other instruments (page 37).

Problem	Cause	Solution
The Bluetooth-equipped device cannot be paired with nor connected to this instrument.	The Bluetooth function of this instrument is off.	Make sure that the Bluetooth function is turned on (page 53).
	The Bluetooth-equipped device is not paired with this instrument.	The device and this instrument need to be paired to each other via Bluetooth (page 52).
	The Bluetooth function of the Bluetooth-equipped device is not activated.	Make sure that the function is activated.
	This instrument and the Bluetooth-equipped device are too far apart.	Use the device in close proximity to this instrument.
	There is a device (microwave oven, wireless LAN device, etc.) that outputs signals in the 2.4 GHz frequency band nearby.	Move the instrument away from any devices that might be emitting radio-frequency signals.
Sound input via Bluetooth is interrupted.	The output volume of the Bluetooth-equipped device connected to this instrument is too low, resulting in the sound being cut off via the Noise Gate after it is input to this instrument.	Increase the output volume of the device. The volume level reproduced via this instrument can be adjusted by using the [VOLUME] control.
Sound input to the [AUX IN] jacks is interrupted.	The output volume of the external device connected to this instrument is too low, resulting in the sound being cut off via the Noise Gate after it is input to this instrument.	Increase the output volume of the external device. The volume level reproduced via this instrument can be adjusted by using the [VOLUME] control.
		Set the Noise Gate to off (page 43).

*The message list (page 56) is also provided for your reference.

Voice List

The cells marked by “✓” indicate the available characteristics (which are explained below) for the Voice.

- Stereo Sampling: Stereo sampling is used for the Voice.
- Touch Sensitivity: The volume responds to your playing strength.
- Key-off Sampling: The key-off sound (the subtle sound that occurs when you release a key) is sampled for the Voice.
- VRM: Simulated string resonance sound with physical modeling when the damper pedal is pressed or keys are pressed. This can be turned on or off. For details, refer to page 40.

Display	Voice Name	Description	Stereo Sampling	Touch Sensitivity	Key-off Sampling	VRM
Piano						
<i>PF 1</i>	Binaural CFX Grand	Yamaha's CFX concert grand piano sound sampled by Binaural Sampling, the method optimized for headphone use. Listening this through headphones gives the impression of being immersed in the sound, as if it was actually emanating from the piano. This is available when the Binaural setting is turned on (page 40).	✓	✓	✓	✓
	CFX Grand	Yamaha's CFX concert grand piano sound with a wide dynamic range for maximum expressive control. Suitable for playing in any music genre and style. This is available when the Binaural setting is turned off (page 40).	✓	✓	✓	✓
<i>PF 2</i>	Bösendorfer Imperial	The famed sound of the Vienna-made Bösendorfer Imperial concert grand piano. Its spacious sound evokes the size of the instrument, and is ideal for expressing tenderness in compositions.	✓	✓	✓	✓
<i>PF 3</i>	Upright Piano	The sound sampled from an upright piano, the Yamaha SU7. Enjoy the unique tonal character and a lighter, more casual feel.	✓	✓	–	✓
<i>PF 4</i>	Pop Grand	A slightly brighter piano sound. Good for popular styles.	✓	✓	✓	✓
<i>PF 5</i>	Ballad Grand	Grand piano sound with a soft and warm tone. Good for playing ballads.	✓	✓	✓	✓
E. Piano						
<i>EP 1</i>	Stage E.Piano	The sound of an electric piano using hammer-struck metallic “tines.” A soft tone results when played lightly, and an aggressive tone when played hard.	–	✓	✓	–
<i>EP 2</i>	DX E.Piano	An electronic piano sound produced by an FM synthesizer. The tone will change as you vary your playing touch. Ideal for popular music.	–	✓	–	–
<i>EP 3</i>	Vintage E.Piano	A different type of electric piano sound than Stage E. piano. Widely used in rock and popular music.	–	✓	✓	–

Display	Voice Name	Description	Stereo Sampling	Touch Sensitivity	Key-off Sampling	VRM
Harpichord						
H51	Harpichord 8'	The sound of an instrument frequently used in baroque music. Variations in playing touch will not affect the volume, and a characteristic sound will be heard when you release the key.	✓	–	✓	–
H52	Harpichord 8'+4'	A harpichord with an added upper octave. Produces a more brilliant sound.	✓	–	✓	–
H53	Celesta	The sound of a celesta (a percussion instrument in which hammers strike tuned metal bars). This instrument is well-known for its appearance in "Dance of the Sugarplum Fairies" from Tchaikovsky's "Nutcracker Suite."	✓	✓	–	–
Organ						
Or1	Organ Principal	This Voice features the combination of pipes (8'+4'+2') of a principal (brass instrument) organ. It is suitable for Baroque church music.	✓	–	–	–
Or2	Organ Tutti	This Voice features a full coupler of a pipe organ, famous for the sound used in Toccata and Fugue by Bach.	✓	–	–	–
Or3	Jazz Organ	The sound of a "tonewheel" type electric organ. Sampled with a Rotary SP effect, its rotation speed is slow. Often heard in jazz and rock idioms.	–	–	–	–
Pad						
Pd1	Strings	Stereo-sampled, large-scale strings ensemble with realistic reverb. Try combining this Voice with piano in the Dual mode.	✓	✓	–	–
Pd2	Choir	A large, spacious choir Voice. Perfect for creating rich harmonies in slow pieces.	✓	✓	–	–
Pd3	Synth Pad	A warm, mellow, and spacious synth sound. Ideal for sustained parts in the background of an ensemble.	–	✓	–	–
Layer						
L41	Piano + Strings	Combination of piano and strings ensemble Voices, giving you a richly textured sound as if you were playing the piano with orchestral accompaniment.	✓	✓	✓	–
L42	Piano + Pad	Combination of piano and Synth Pad Voices.	✓	✓	✓	–
L43	Piano + DX E. Piano	Combination of piano and DX E. Piano Voices.	✓	✓	✓	–

Song List

■ Voice Demo Songs

No.	Voice Name	Song Name	Composer
d.01	CFX Grand	Widmung S.566 R.253	F. Liszt / R. Schumann
	Binaural CFX Grand		
d.02	Bösendorfer Imperial	Mädchens Wunsch (6 Chants polonaise S.480 R.145)	F. Liszt / F. F. Chopin
d.03	Upright Piano	Italienisches Konzert, BWV 971 1st mov.	J. S. Bach
d.04	Pop Grand	Original	—
d.05	Ballad Grand	Original	—
d.06	Stage E.Piano	Original	—
d.07	DX E.Piano	Original	—
d.08	Vintage E.Piano	Original	—
d.09	Harpsichord 8'	Concerto a cembalo obbligato, 2 violini, viola e continuo No.7, BWV 1058	J. S. Bach
d.10	Harpsichord 8'+4'	Gigue, Französische Suiten No.5, BWV 816	J. S. Bach
d.11	Celesta	Danse de la Fée Dragée	P. I. Tchaikovsky
d.12	Organ Principal	Herr Christ, der ein'ge Gottes-Sohn, BWV 601	J. S. Bach
d.13	Organ Tutti	Original	—
d.14	Jazz Organ	Original	—
d.15	Strings	Original	—
d.16	Choir	Original	—
d.17	Synth Pad	Original	—
d.18	Piano + Strings	Original	—
d.19	Piano + Pad	Original	—
d.20	Piano + DX E.Piano	Original	—

■ Preset Songs (50 Classical Music Masterpieces)

No.	Song Name	Composer
Arrangements		
P.01	Canon D dur	J. Pachelbel
P.02	Air On the G Strings	J. S. Bach
P.03	Jesus, Joy of Man's Desiring	J. S. Bach
P.04	Twinkle, Twinkle, Little Star	Traditional
P.05	Piano Sonate op.31-2 "Tempest" 3rd mov.	L. v. Beethoven
P.06	Ode to Joy	L. v. Beethoven
P.07	Wiegenlied op.98-2	F. P. Schubert
P.08	Grande Valse Brillante	F. F. Chopin
P.09	Polonaise op.53 "Héroïque"	F. F. Chopin
P.10	La Campanella	F. Liszt
P.11	Salut d'amour op.12	E. Elgar
P.12	From the New World	A. Dvořák
P.13	Sicilienne	G. U. Fauré
P.14	Clair de lune	C. A. Debussy
P.15	Jupiter (The Planets)	G. Holst

No.	Song Name	Composer
Duets		
P.16	Menuett (Eine kleine Nachtmusik K.525)	W. A. Mozart
P.17	Menuett G dur	L. v. Beethoven
P.18	Marcia alla Turca	L. v. Beethoven
P.19	Piano Concerto No.1 op.11 2nd mov.	F. F. Chopin
P.20	The Nutcracker Medley	P. I. Tchaikovsky
Original Compositions		
P.21	Prelude (Wohltemperierte Klavier I No.1)	J. S. Bach
P.22	Menuett G dur BWV Anh.114	J. S. Bach
P.23	Piano Sonate No.15 K.545 1st mov.	W. A. Mozart
P.24	Turkish March	W. A. Mozart
P.25	Piano Sonate op.13 "Pathétique" 2nd mov.	L. v. Beethoven
P.26	Für Elise	L. v. Beethoven
P.27	Piano Sonate op.27-2 "Mondschein" 1st mov.	L. v. Beethoven
P.28	Impromptu op.90-2	F. P. Schubert
P.29	Frühlingslied op.62-6	J. L. F. Mendelssohn
P.30	Fantaisie-Impromptu	F. F. Chopin
P.31	Etude op.10-3 "Chanson de l'adieu"	F. F. Chopin
P.32	Etude op.10-12 "Revolutionary"	F. F. Chopin
P.33	Valse op.64-1 "Petit chien"	F. F. Chopin
P.34	Nocturne op.9-2	F. F. Chopin
P.35	Nocturne KK4a-16/BI 49 [Posth.]	F. F. Chopin
P.36	Träumerei	R. Schumann
P.37	Barcarolle	P. I. Tchaikovsky
P.38	La prière d'une Vierge	T. Badarzewska
P.39	Liebesträume No.3	F. Liszt
P.40	Blumenlied	G. Lange
P.41	Humoresque	A. Dvořák
P.42	Arietta	E. H. Grieg
P.43	Tango (España)	I. Albéniz
P.44	The Entertainer	S. Joplin
P.45	Maple Leaf Rag	S. Joplin
P.46	La Fille aux Cheveux de Lin	C. A. Debussy
P.47	Arabesque No. 1	C. A. Debussy
P.48	Cakewalk	C. A. Debussy
P.49	Je te veux	E. Satie
P.50	Gymnopédies No.1	E. Satie

Playback sequence of Song files in a USB flash drive

The illustration below shows the playback sequence of Song files stored on the USB flash drive.

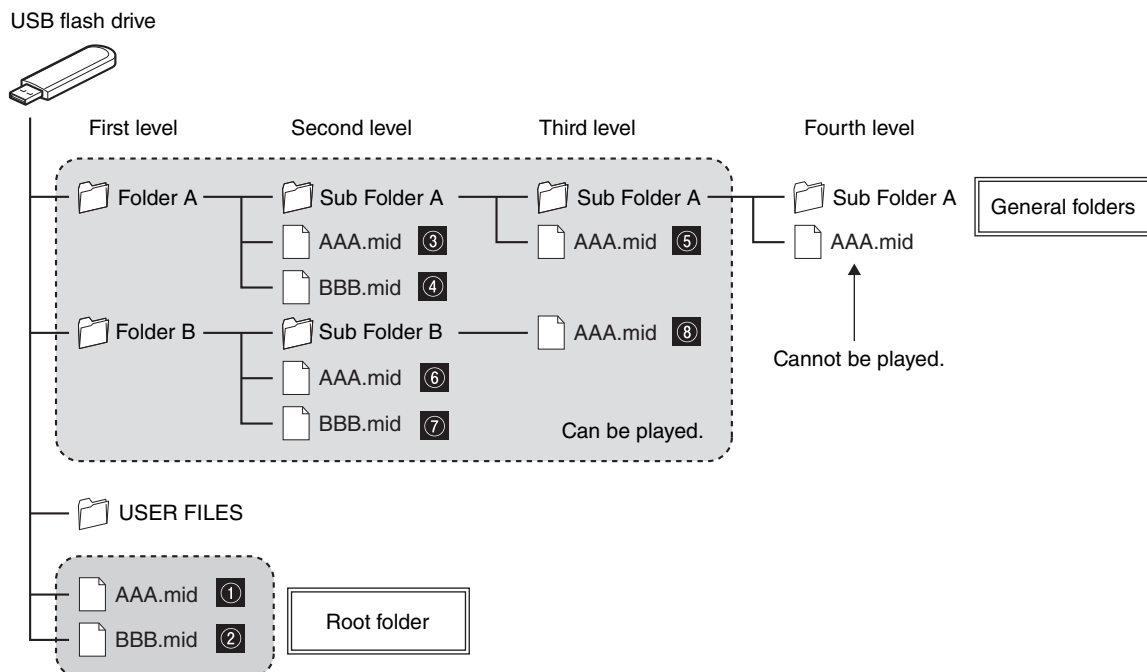

■ Playback sequence of User Songs

User Songs are named as follows, and saved in the USER FILES folder.

The “**” section indicates the Song number. Songs are played back in order of the number in the “**” section.

- USERSONG**.MID (MIDI Song)
- USERAUDIO**.WAV (Audio Song)

■ Playback sequence of External Songs

Priority	Folder/File	
1	Root folder	Songs are played back first in numeric order, and then in alphabetical order.
2	General folders	

NOTE

This unit cannot recognize Song files saved in a folder lower than the third level. If you manage Song files in a USB flash drive with a computer, make sure to save them to the first, second or third level folder.

Specifications

			Upright Piano	Grand Piano	
Control Interface	Keyboard	Touch Response	Hard, Medium/Hard, Medium, Soft/Medium, Soft, Fixed		
	Pedal		Damper, Silencing/Sostenuto ^{*1} , Soft	Damper, Sostenuto ^{*1} , Soft	
	Sensor System	Key Sensors		Non-contact continuous detection optical sensor	
		Hammer Sensors		–	Non-contact 2-point optical fiber sensor
		Damper Pedal		Continuous detection sensor	
		Sostenuto Pedal		On/Off detection sensor	
		Soft Pedal		On/Off detection sensor	
Silencing System	Mechanism		Hammer shank stopper operated by silencing pedal/silencing lever ^{*1}	Hammer shank stopper operated by motor drive	
	Action		–	Quick Escape mechanism	
Voices	Tone Generation	Piano Sound	Yamaha CFX, Bösendorfer Imperial		
		Binaural Sampling	Yes (CFX Grand Voice only)		
	Piano Effect	VRM	Yes		
		Key-off Samples	Yes		
		Smooth Release	Yes		
	Polyphony (max.)		256		
	Preset	Number of Voices	20		
	Voices for Song Playback		480 XG Voices + 12 Drum/SFX Kits		
Effects	Types	Reverb	Yes		
		Brilliance	Yes		
		Stereophonic Optimizer	Yes		
Songs (MIDI)	Preset	Number of Preset Songs	20 Voice Demo Songs, 50 Classics		
	Recording	Number of Songs	10		
		Data Capacity	approx. 500 KB/Song		
	Format	Playback	SMF (Format 0, Format 1)		
Recording		SMF (Format 0)			
Recording/ Playback (Audio)	Recording Time (max.)		80 minutes/Song		
	Format	Playback	WAV (44.1 kHz, 16 bit, stereo)		
		Recording	WAV (44.1 kHz, 16 bit, stereo)		
Functions	Overall Controls	Metronome	Yes		
		Tempo Range	5 – 500		
		Transpose	-12 – 0 – +12		
		Tuning	414.8 – 440.0 – 466.8 Hz (approx. 0.2 Hz increments)		
	USB Audio Interface		44.1 kHz, 16 bit, stereo		
	Bluetooth	Bluetooth version		4.1	
		Supported profile		A2DP	
		Compatible codec		SBC	
		Wireless output		Bluetooth class 2	
		Maximum communication distance		approx. 10 m (33 ft)	
		Range of transmit frequency		2,402 – 2,480 MHz	
Maximum RF output Power		4 dBm			

			Upright Piano	Grand Piano
Storage and Connectivity	Storage	Internal Memory	approx. 1.3 MB	
		External Drives	USB flash drive	
	Connectivity	DC IN	16 V	
		Headphones	Stereo mini jack (x2)	
		MIDI	IN/OUT	
		AUX IN	Stereo mini jack	
		AUX OUT	[L/L+R] [R] (Standard phone jack)	
		USB TO DEVICE	Yes	
USB TO HOST	Yes			
Power Supply	AC Adaptor		PA-300C (or an equivalent recommended by Yamaha)	
	Power Consumption		12W (When using PA-300C AC adaptor)	
	Auto Power Off		Yes	
Weight (excluding the weight of the piano body)			4 kg (8 lb, 13 oz)	9 kg (19 lb, 13 oz)
Included Accessories			AC adaptor*, power cord*, headphones, headphone hanger, attachment screws for headphone hanger, "50 Classical Music Masterpieces" music book, Owner's Manual *May not be included depending on your area. Check with your Yamaha dealer.	
Separately Sold Accessories (May not be available depending on your area.)			USB wireless LAN adaptor (UD-WL01), wireless MIDI adaptor (UD-BT01/MD-BT01)	

*1 For models equipped with a sostenuto pedal.

The contents of this manual apply to the latest specifications as of the publishing date. To obtain the latest manual, access the Yamaha website then download the manual file. Since specifications, equipment or separately sold accessories may not be the same in every locale, please check with your Yamaha dealer.

Index

- A**
- Access Point mode 51
 - Accessories 10
 - Aliquot Resonance 41
 - All-repeat playback 21
 - Audio Loop Back 44
 - Audio recording 24
 - Audio Song 20
 - Auto Power Off 16, 43
 - [AUX IN] jack 48
 - AUX IN Noise Gate 43
 - AUX OUT jacks 47
- B**
- Backup data 54
 - Base note 38
 - Beat 33
 - Binaural 40
 - Binaural Sampling 19
 - Bluetooth 53
 - Bluetooth Audio 52
 - Body Resonance 42
 - Brilliance 36
- C**
- Character Code 55
 - Computer 50
 - Computer-related Operations .. 10
 - Continuous playback 21
 - Control unit 13
 - Copy (User Song) 27
- D**
- Damper Resonance 41
 - Delete (User Song) 28
 - Demo Song 20, 62
 - Display 14
- E**
- External Song 20
- F**
- Fast forward 22
 - Fixed velocity 36
 - Format (USB flash drive) 46
 - Function settings 34
- H**
- Half Pedal 39
 - Headphone hanger 16
 - Headphones 16
- I**
- Included Accessories 10
 - Infrastructure mode 51
 - Initialization 54
- K**
- Keyboard transpose 36
 - Key-off Sampling 42
- L**
- Local Control 42
- M**
- Master Tune 37
 - Message List 56
 - Metronome 32
 - MIDI jacks 49
 - MIDI recording 24
 - MIDI Song 20
 - MIDI transmit channel 42
- N**
- Noise Gate 43
- P**
- Pairing 44, 52
 - Pause 22
 - Pedal 12
 - Playback 20
 - Playback sequence (Song) 64
 - Power 15
 - Preset Song 20, 62
- R**
- Random playback 21
 - Recording 24
 - Reverb 30
 - Rewind 22
- S**
- Scale type 37
 - Silencing lever 12, 17
 - Silent Piano function 17
 - Smart device 50
 - Smart Pianist 11
 - Song (playback sequence) 64
 - Song Category 20
 - Song List 62
 - SONG mode 13, 20
 - Song transpose 39
 - Specifications 65
 - Stereophonic Optimizer 19
 - Stop 22
 - String Resonance 41
- T**
- Temperament 37
 - Tempo (metronome) 32
 - Tempo (Song) 23
 - Time signature 33
 - Touch Sensitivity (Touch Response) 36
 - Transpose (keyboard) 36
 - Transpose (Song) 39
 - Troubleshooting 58
 - Tuning 37
- U**
- USB Audio Interface 51
 - USB device 45
 - USB flash drive 45
 - USB [TO DEVICE] terminal ... 45
 - USB wireless LAN 51
 - User Song 20, 27
 - UTILITY mode 13, 30
- V**
- Version 44
 - Voice 18
 - Voice Demo Song 20, 62
 - Voice List 19, 60
 - VOICE mode 13, 18
 - Volume (Audio Song) 39
 - Volume (master volume) 18
 - Volume (metronome) 38
 - Volume (MIDI Song) 38
 - VRM (Virtual Resonance Modeling) 40

MEMO

For U.S.A.

This transmitter must not be co-located or operated in conjunction with any other antenna or transmitter.

For CANADA

This device complies with Industry Canada licence-exempt RSS standard(s). Operation is subject to the following two conditions: (1) this device may not cause interference, and (2) this device must accept any interference, including interference that may cause undesired operation of the device.

Le présent appareil est conforme aux CNR d'Industrie Canada applicables aux appareils radio exempts de licence. L'exploitation est autorisée aux deux conditions suivantes : (1) l'appareil ne doit pas produire de brouillage, et (2) l'utilisateur de l'appareil doit accepter tout brouillage radioélectrique subi, même si le brouillage est susceptible d'en compromettre le fonctionnement.

For U.S.A. and CANADA

This equipment complies with FCC/IC radiation exposure limits set forth for an uncontrolled environment and meets the FCC radio frequency (RF) Exposure Guidelines and RSS-102 of the IC radio frequency (RF) Exposure rules. This equipment has very low levels of RF energy that are deemed to comply without testing of specific absorption rate (SAR).

Cet équipement est conforme aux limites d'exposition aux rayonnements énoncées pour un environnement non contrôlé et respecte les règles des radioélectriques (RF) de la FCC lignes directrices d'exposition et d'exposition aux fréquences radioélectriques (RF) CNR-102 de l'IC. Cet équipement émet une énergie RF très faible qui est considérée conforme sans évaluation du débit d'absorption spécifique (DAS).

For EU countries

BG Bulgarian

ОПРОСТЕНА ЕС ДЕКЛАРАЦИЯ ЗА СЪОТВЕТСТВИЕ

С настоящото Yamaha Music Europe GmbH декларира, че този тип радиосъоръжение [SH2] е в съответствие с Директива 2014/53/ЕС. Цялостният текст на ЕС декларацията за съответствие може да се намери на следния интернет адрес:
<https://europe.yamaha.com/en/support/compliance/doc.html>

ES Spanish

DECLARACIÓN UE DE CONFORMIDAD SIMPLIFICADA

Por la presente, Yamaha Music Europe GmbH declara que el tipo de equipo radioeléctrico [SH2] es conforme con la Directiva 2014/53/UE. El texto completo de la declaración UE de conformidad está disponible en la dirección Internet siguiente:
<https://europe.yamaha.com/en/support/compliance/doc.html>

CS Czech

ZJEDNODUŠENÉ EU PROHLÁŠENÍ O SHODĚ

Tímto Yamaha Music Europe GmbH prohlašuje, že typ rádiového zařízení [SH2] je v souladu se směrnicí 2014/53/EU. Úplné znění EU prohlášení o shodě je k dispozici na této internetové adrese:
<https://europe.yamaha.com/en/support/compliance/doc.html>

DA Danish

FORENKLET EU-OVERENSSTEMMELSESERKLÆRING

Herved erklærer Yamaha Music Europe GmbH, at radioudstyrstypen [SH2] er i overensstemmelse med direktiv 2014/53/EU. EU-overensstemmelseserklæringens fulde tekst kan findes på følgende internetadresse:
<https://europe.yamaha.com/en/support/compliance/doc.html>

DE German

VEREINFACHTE EU-KONFORMITÄTSERKLÄRUNG

Hiermit erklärt Yamaha Music Europe GmbH, dass der Funkanlagentyp [SH2] der Richtlinie 2014/53/EU entspricht. Der vollständige Text der EU-Konformitätserklärung ist unter der folgenden Internetadresse verfügbar:
<https://europe.yamaha.com/en/support/compliance/doc.html>

ET Estonian

LIHTSUSTATUD ELI VASTAVUSDEKLARATSIOON

Käesolevaga deklareerib Yamaha Music Europe GmbH, et käesolev raadioseadme tüüp [SH2] vastab direktiivi 2014/53/EL nõuetele. ELi vastavusdeklaratsiooni täielik tekst on kättesaadav järgmisel internetiaadressil:
<https://europe.yamaha.com/en/support/compliance/doc.html>

EL Greek

ΑΠΛΟΥΣΤΕΥΜΕΝΗ ΔΗΛΩΣΗ ΣΥΜΜΟΡΦΩΣΗΣ ΕΕ

Με την παρούσα ο/η Yamaha Music Europe GmbH, δηλώνει ότι ο ραδιοεξοπλισμός [SH2] πληροί την οδηγία 2014/53/ΕΕ. Το πλήρες κείμενο της δήλωσης συμμόρφωσης ΕΕ διατίθεται στην ακόλουθη ιστοσελίδα στο διαδίκτυο:
<https://europe.yamaha.com/en/support/compliance/doc.html>

EN English

SIMPLIFIED EU DECLARATION OF CONFORMITY

Hereby, Yamaha Music Europe GmbH declares that the radio equipment type [SH2] is in compliance with Directive 2014/53/EU. The full text of the EU declaration of conformity is available at the following internet address:
<https://europe.yamaha.com/en/support/compliance/doc.html>

FR French

DECLARATION UE DE CONFORMITE SIMPLIFIEE

Le soussigné, Yamaha Music Europe GmbH, déclare que l'équipement radioélectrique du type [SH2] est conforme à la directive 2014/53/UE. Le texte complet de la déclaration UE de conformité est disponible à l'adresse internet suivante:
<https://europe.yamaha.com/en/support/compliance/doc.html>

HR Croatian

POJEDNOSTAVLJENA EU IZJAVA O SUKLADNOSTI

Yamaha Music Europe GmbH ovime izjavljuje da je radijska oprema tipa [SH2] u skladu s Direktivom 2014/53/EU. Cjeloviti tekst EU izjave o sukladnosti dostupan je na sljedećoj internetskoj adresi:
<https://europe.yamaha.com/en/support/compliance/doc.html>

IT Italian

DICHIARAZIONE DI CONFORMITÀ UE SEMPLIFICATA

Il fabbricante, Yamaha Music Europe GmbH, dichiara che il tipo di apparecchiatura radio [SH2] è conforme alla direttiva 2014/53/UE. Il testo completo della dichiarazione di conformità UE è disponibile al seguente indirizzo Internet:
<https://europe.yamaha.com/en/support/compliance/doc.html>

LV Latvian

VIENKĀRŠOTA ES ATBILSTĪBAS DEKLARĀCIJA

Ar šo Yamaha Music Europe GmbH deklarē, ka radioiekārta [SH2] atbilst Direktīvai 2014/53/ES. Pilns ES atbilstības deklarācijas teksts ir pieejams šādā interneta vietnē:
<https://europe.yamaha.com/en/support/compliance/doc.html>

LT Lithuanian

SUPAPRASTINTA ES ATITIKTIES DEKLARACIJA

Aš, Yamaha Music Europe GmbH, patvirtinu, kad radio įrenginių tipas [SH2] atitinka Direktyvą 2014/53/ES. Visas ES atitikties deklaracijos tekstas prieinamas šiuo interneto adresu:
<https://europe.yamaha.com/en/support/compliance/doc.html>

HU Hungarian

EGYSZERŰSÍTETT EU-MEGFELELŐSÉGI NYILATKOZAT

Yamaha Music Europe GmbH igazolja, hogy a [SH2] típusú rádióberendezés megfelel a 2014/53/EU irányelvnek. Az EU-megfelelőségi nyilatkozat teljes szövege elérhető a következő internetes címen:
<https://europe.yamaha.com/en/support/compliance/doc.html>

NL Dutch

VEREENVOUDIGDE EU-CONFORMITEITSVERKLARING

Hierbij verklaar ik, Yamaha Music Europe GmbH, dat het type radioapparatuur [SH2] conform is met Richtlijn 2014/53/EU. De volledige tekst van de EU-conformiteitsverklaring kan worden geraadpleegd op het volgende internetadres:
<https://europe.yamaha.com/en/support/compliance/doc.html>

PL Polish

UPROSZCZONA DEKLARACJA ZGODNOŚCI UE

Yamaha Music Europe GmbH niniejszym oświadcza, że typ urządzenia radiowego [SH2] jest zgodny z dyrektywą 2014/53/EU. Pełny tekst deklaracji zgodności UE jest dostępny pod następującym adresem internetowym:
<https://europe.yamaha.com/en/support/compliance/doc.html>

PT Portuguese

DECLARAÇÃO UE DE CONFORMIDADE SIMPLIFICADA

O(a) abaixo assinado(a) Yamaha Music Europe GmbH declara que o presente tipo de equipamento de rádio [SH2] está em conformidade com a Diretiva 2014/53/UE. O texto integral da declaração de conformidade está disponível no seguinte endereço de Internet:
<https://europe.yamaha.com/en/support/compliance/doc.html>

RO Romanian

DECLARAȚIA UE DE CONFORMITATE SIMPLIFICATĂ

Prin prezenta, Yamaha Music Europe GmbH declară că tipul de echipamente radio [SH2] este în conformitate cu Directiva 2014/53/UE. Textul integral al declarației UE de conformitate este disponibil la următoarea adresă internet:
<https://europe.yamaha.com/en/support/compliance/doc.html>

SK Slovak

ZJEDNODUŠENÉ EÚ VYHLÁSENIE O ZHODE

Yamaha Music Europe GmbH týmto vyhlasuje, že rádiové zariadenie typu [SH2] je v súlade so smernicou 2014/53/EÚ. Úplné EÚ vyhlásenie o zhode je k dispozícii na tejto internetovej adrese:
<https://europe.yamaha.com/en/support/compliance/doc.html>

SL Slovenian

POENOSTAVLJENA IZJAVA EU O SKLADNOSTI

Yamaha Music Europe GmbH potrjuje, da je tip radijske opreme [SH2] skladen z Direktivo 2014/53/EU. Celotno besedilo izjave EU o skladnosti je na voljo na naslednjem spletnem naslovu:
<https://europe.yamaha.com/en/support/compliance/doc.html>

FI Finnish

YKSINKERTAISTETTU EU-VAATIMUSTENMUKAISUUSVAKUUTUS

Yamaha Music Europe GmbH vakuuttaa, että radiolaitetyypin [SH2] on direktiivin 2014/53/EU mukainen. EU-vaatimustenmukaisuusvakuutuksen täysimittainen teksti on saatavilla seuraavassa internetosoitteessa:
<https://europe.yamaha.com/en/support/compliance/doc.html>

SV Swedish

FÖRENKLAD EU-FÖRSÄKRAN OM ÖVERENSSTÄMMELSE

Härmed försäkrar Yamaha Music Europe GmbH att denna typ av radioutrustning [SH2] överensstämmer med direktiv 2014/53/EU. Den fullständiga texten till EU-försäkran om överensstämmelse finns på följande webbadress:
<https://europe.yamaha.com/en/support/compliance/doc.html>

TR Turkey

BASİTLEŞTİRİLMİŞ AVRUPA BİRLİĞİ UYGUNLUK BİLDİRİMİ

İşbu belge ile, Yamaha Music Europe GmbH, radyo cihaz tipinin [SH2], Direktif 2014/53/AB'ye uygunluğunu beyan eder. AB uyumu beyanının tam metni aşağıdaki internet adresinden edinilebilir:
<https://europe.yamaha.com/en/support/compliance/doc.html>

Yamaha Music Europe GmbH

Siemensstr. 22-34 25462 Rellingen, Germany
Tel: +49-4101-303-0





YAMAHA CORPORATION
10-1, Naka-ku, Hamamatsu, 430-8650 JAPAN

Manual Development Group
© 2018 Yamaha Corporation

Published 10/2019 MW-B0

YJ843B0